

## Connection

### 1. Connect to a network

When using wired connection, connect the TV and a router with a LAN cable. When using wireless connection, you need to set the Network Setup in the Initial Setup Wizard (on step 6).

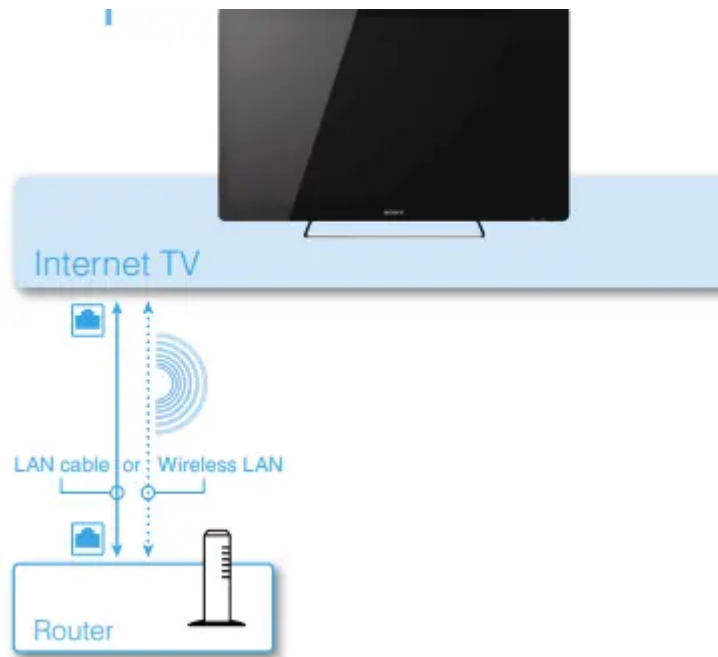

### 2. Connect the Cable/Satellite Box

Use one of the connection cables illustrated below. Then, place the IR Blaster near the remote sensor of the Cable/Satellite Box.

Place the IR Blaster so that the infrared transmitter points to the remote sensor of the Cable/Satellite Box. For details on the IR Blaster, see "Help Guide" on the back side.

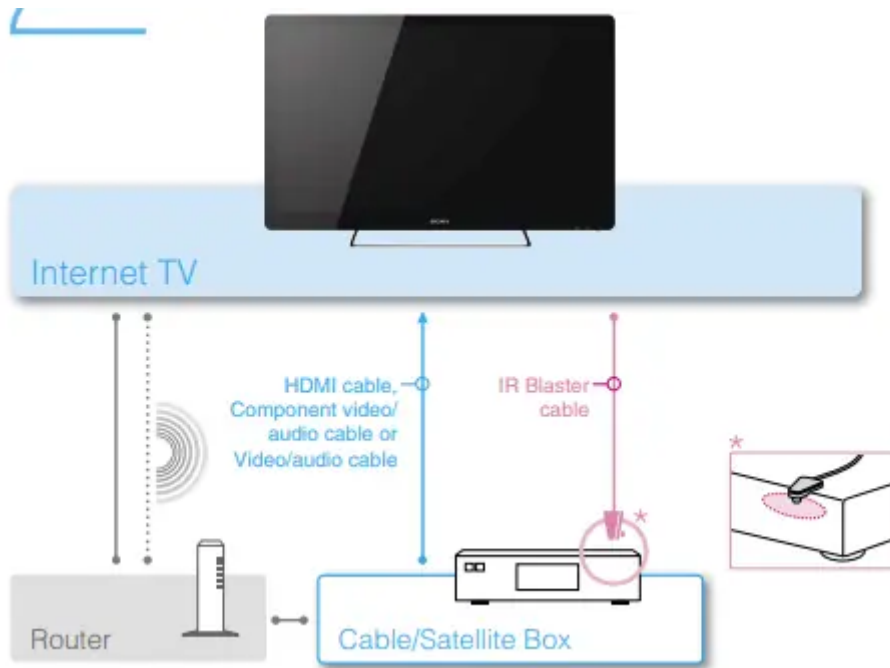

- When connecting the Cable/Satellite Box with an HDMI cable, you can use any HDMI jack on the TV.
- For details of network connection with the Cable/Satellite Box, see the operating instructions supplied with the Cable/Satellite Box.
- You can control a Cable/Satellite Box via the Home Network depending on your Cable/Satellite TV provider. For details, see "Help Guide" on the back side

### 3. Connect other devices

Connect the AV Receiver and other devices to the TV if necessary

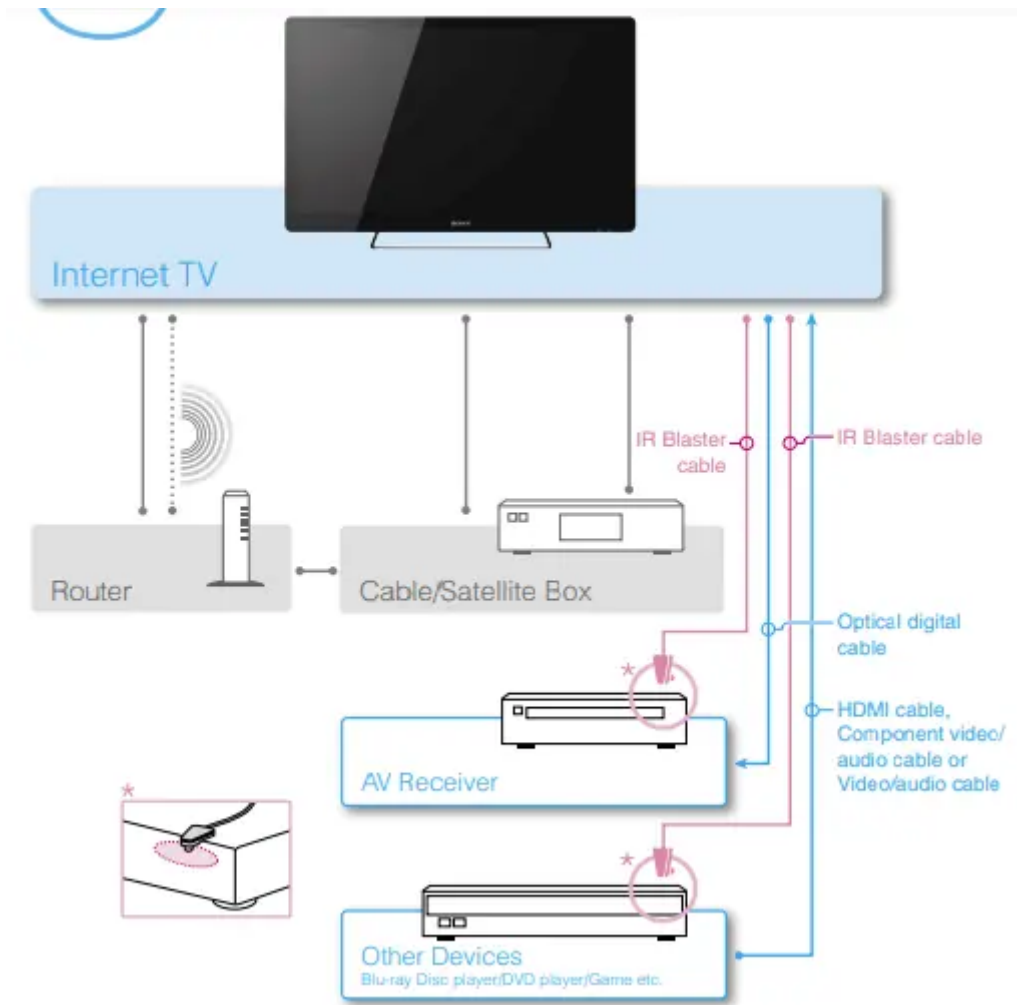

#### 4. Connect to the power source

Plug the TV into the wall outlet.

- Refer to the Table-Top Stand leaflet (supplied) for directions on how to attach the AC power cord (except NSX-24GT1) and the cable cover.

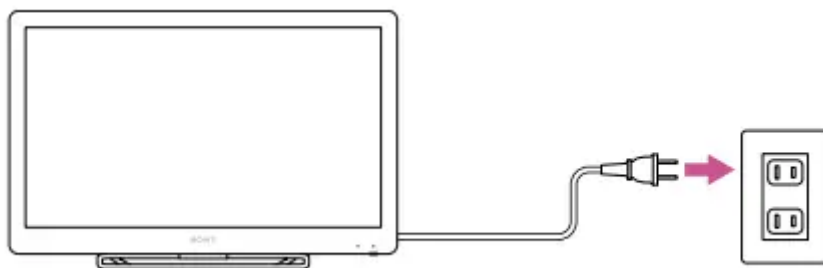

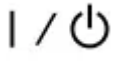
5. Press the  (on/standby) button

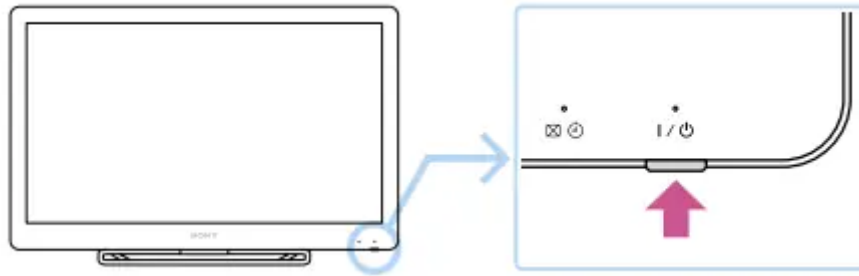

## 6. Start Internet TV setup

Follow the directions of the Initial Setup Wizard displayed on the screen.

- When you skip the Network Setup, only limited functions will be available with the TV.
- The screen may stay dark for several seconds after the Sony logo disappears. Wait for a while until the Initial Setup Wizard is displayed.
- It takes about 15 minutes to complete the Initial Setup.



\* This illustration may differ from the actual display

## Keypad

### A. OPTICAL FINGER SENSOR (OFS)

Allows you to control the pointer with just your thumb. To operate the pointer, slide your thumb on the OFS. To click, press down on the OFS.

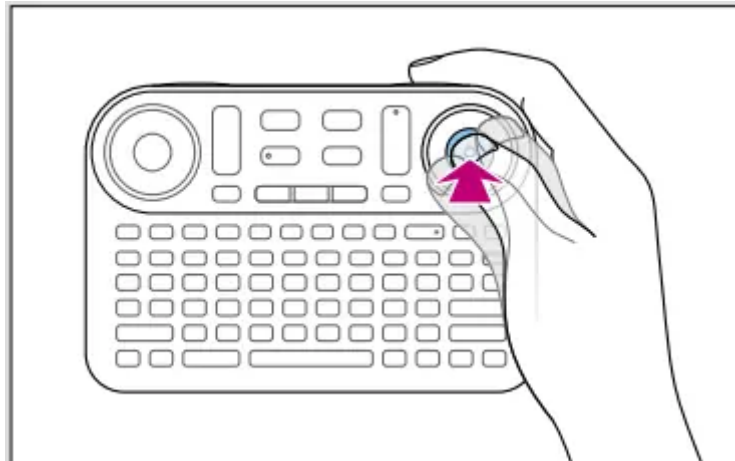

## B. SCROLL

Scrolls a page or list. Hold down SCROLL and slide your thumb up and down on the OFS.

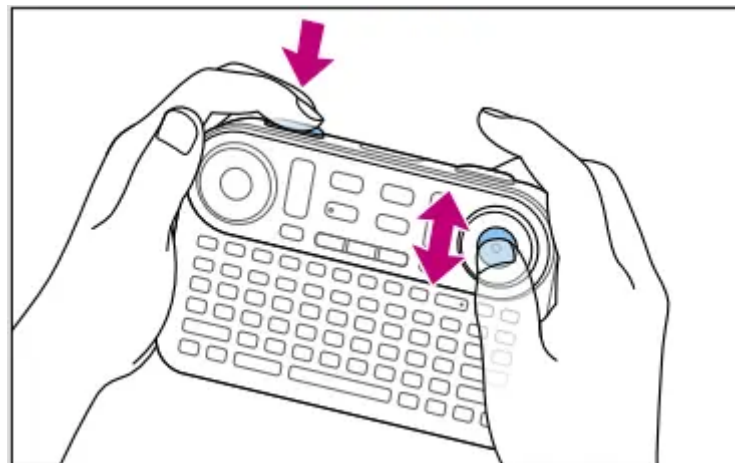

## C. ZOOM

Zooms images. Hold down ZOOM and slide your thumb up and down on the OFS.

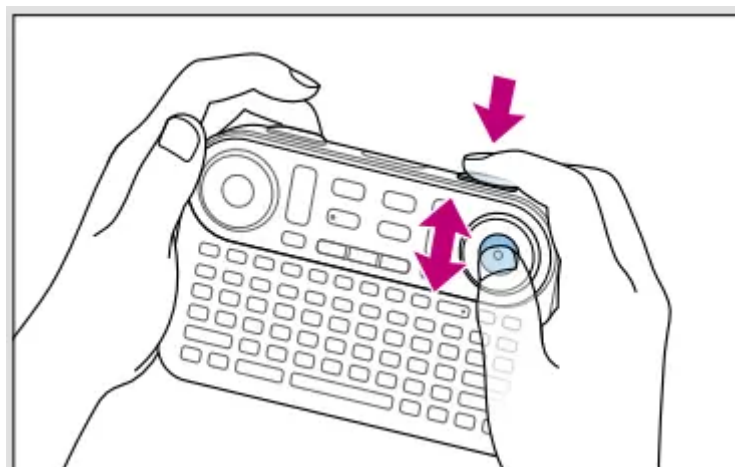

## To drag and drop

Hold down SCROLL and ZOOM, and slide your thumb on the OFS.

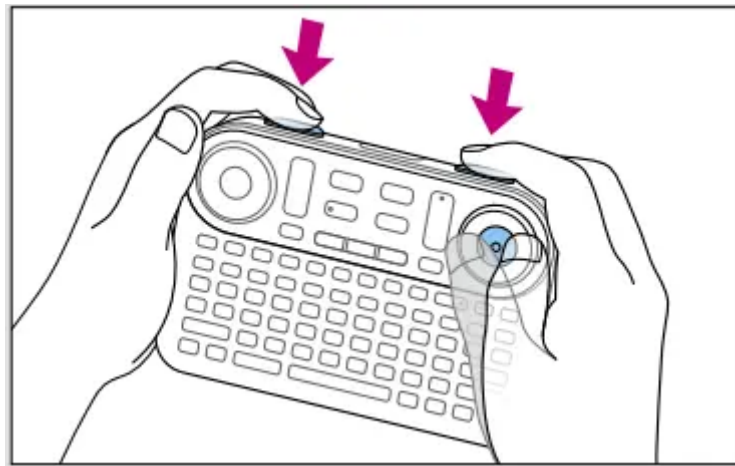

**1. AMP : AMP\***

Allows you to control the connected AV Receiver. Keys beside orange markers are active when the AMP indicator is on.

**2.  ON/STANDBY (BD/EXT)**

Turns on the connected device.

**3.  ON/STANDBY (TV)**

Turns on the TV.

**4.  BOOKMARK**

Bookmarks your favorite content.

5.  **BACK**

Returns to the previous display

6.  **HOME**

Displays the HOME menu. The HOME menu is a gateway to various contents.

7.  **WINDOW**

Switches the window style

8.  **MENU**

Displays menu items according to applications.

9. **GUIDE :GUIDE**

Displays the TV Guide.

10. **TV : TV**

Displays live TV.

11. **DVR : DVR**

Displays the DVR (Digital Video Recorder) menu.

12.  **SEARCH**

Displays the Quick Search Box. Type your interest in the Quick Search Box, and the TV will suggest contents from various media.

## Help Guide

### Find out more about the Internet TV

The Help Guide gives you detailed information on how to use the Internet TV as follows:

- Basics of the Internet TV
- How to use applications
- Details on how to use the Keypad
- Customizing settings
- Software Updates

## To launch the Help Guide

- **From your Internet TV : Select “Help Guide” from the Applications List.**

Or, press  (SEARCH) and type “help” in the Quick Search Box. Help Guide appears in the search results.

- The network connection is required for accessing the “Help Guide” from the TV.
- **From a PC browser**

Access the following web

## Troubleshooting

### Before starting the Initial Setup Wizard

Check the following so that the Initial Setup Wizard operations go smoothly.

- **Network connection**

–Check whether your home network is a wired or wireless connection.

When Wireless LAN is used

–Check whether the wireless access point device such as a Wireless LAN router supports Wi-Fi Protected Setup (WPS). If WPS is not supported, you will need to make a connection manually.

–Check whether the Push or PIN method is used for WPS.

–Check your SSID and Password if setting up the wireless connection manually.

- **Account**

–Check your ID and Password for your Google Account\*.

\* You can create a new account in the Initial Setup Wizard.

- **Cable/Satellite Box**

–Check the Cable/Satellite TV provider name.

- **IR Blaster**

–Check the manufacturer name of the device to be connected with the IR Blaster.

### Before connecting with a Wireless LAN

Check the following to ensure that the Wireless LAN connection can be made.

- Depending on the surrounding environment, such as the wall material, radio wave receiving condition, or obstacles between this TV and the wireless LAN router, the communication distance may be shortened. Move the TV and the wireless LAN router closer to each other.
- Devices that use a 2.4 GHz frequency band, such as a microwave, Bluetooth, or digital cordless device, may interrupt the communication. Move the TV away from such devices, or turn off such devices

### **Frequently-asked questions (FAQ)**

There is no picture (screen is dark).

- Make sure that all the connecting cables are securely connected.
- Make sure that the Power indicator is lit up green.
- If the Power indicator and Timer indicator on the front side are flashing, check the condition of the TV by examining how the Power indicator and Timer indicator on the front side are flashing (numbers of flashes). For details, access the Help Guide.

Tiny black dots and/or bright dots appear on the screen.

- The screen is composed of pixels. Tiny black dots and/or bright dots (pixels) on the screen do not indicate a malfunction.

The Keypad does not function (cannot be paired with the TV).

- Operate the Keypad closer to the TV.
- Make sure that the batteries are inserted correctly.
- Hold down the Fn and Enter keys following the instructions on the screen until the pairing screen disappears.

The TV cannot connect to the Internet.

- Make sure that the LAN router or Wireless LAN router is on.
- Check the settings of the LAN router or Wireless LAN router. For details, see the operating instructions supplied with the LAN router or Wireless LAN router.
- Make sure that the LAN cable is connected correctly when using a wired network connection.
- Check your network environment as noted in “Before connecting with a Wireless LAN” when using a wireless network connection.

The TV cannot connect to the Internet after “Wi-Fi Protected Setup (WPS)” is finished.

- The wireless setting of the router may change automatically if you have used the WPS function before. In this case, change the wireless settings of your PC accordingly

For more information about the Internet TV.

- Access the Help Guide.

## Additional Information

### Parts and controls

NSX-32GT1/NSX-40GT1/NSX-46GT1

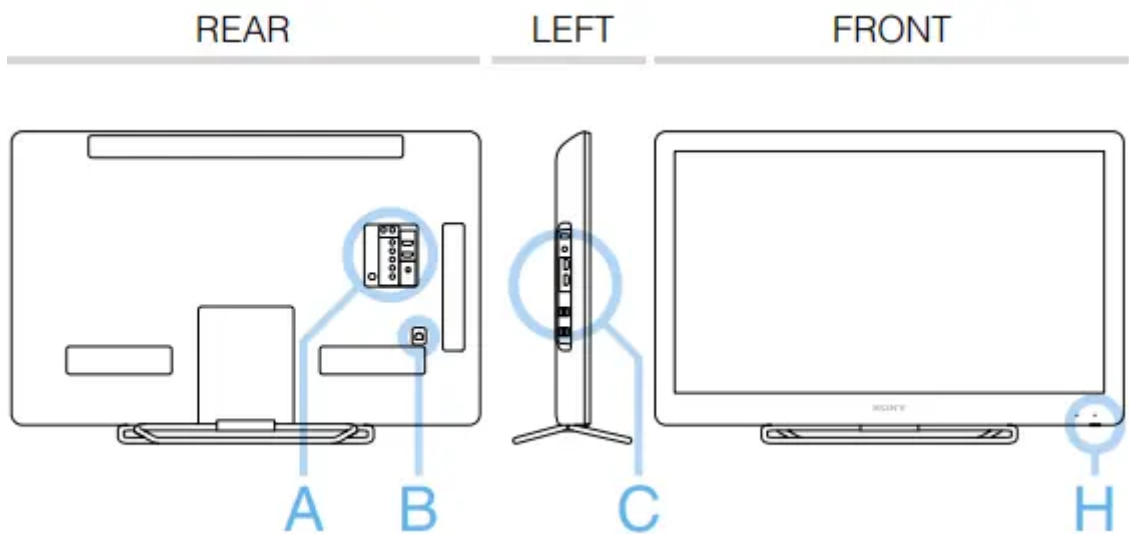

NSX-24GT1

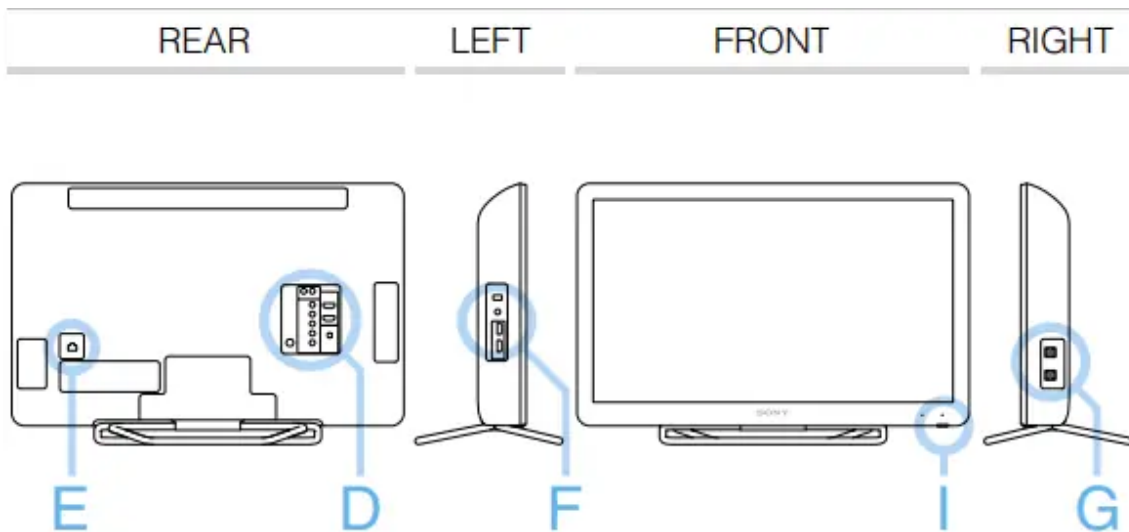

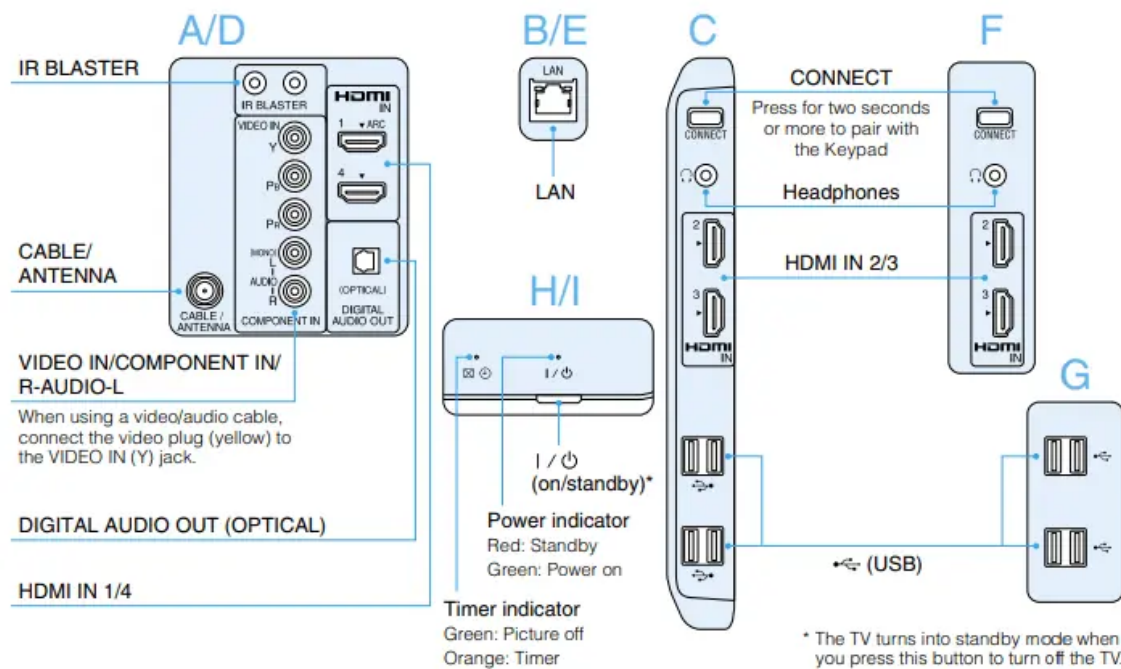

# Specifications

Model Name NSX-	46GT1	40GT1	32GT1	24GT1
<b>System</b>				
Television system	NTSC: American TV standard ATSC (8VSB terrestrial): ATSC compliant 8VSB QAM on cable: ANSI/SCTE 07 2000 (Does not include Cable CARD functionality)			
Channel coverage	Analog terrestrial: 2-69 / Digital terrestrial: 2-69 Analog Cable: 1-135 / Digital Cable: 1-135			
Panel system	LCD (Liquid Crystal Display) Panel			
Speaker output	10W + 10W			5W + 5W
<b>Input/Output jacks</b>				
CABLE/ANTENNA	75-ohm external terminal for RF inputs			
VIDEO IN	VIDEO / AUDIO			
COMPONENT IN	YPBPR (Component Video)/Signal format: 480i, 480p, 720p, 1080i, 1080p AUDIO			
HDMI IN 1/2/3/4	HDMI: Video:480i, 480p, 720p, 1080i, 1080p, 1080/24p Audio: Two channel linear PCM 32, 44.1 and 48KHz, 16, 20 and 24bits, Dolby Digital			
HEADPHONE	Headphones jack			
DIGITAL AUDIO OUT (OPTICAL)	PCM/Dolby Digital optical signal			
LAN	10BASE-T/100BASE-TX/1000BASE-T connector (Connection speed may differ depending on the network environment. 10BASE-T/100BASE-TX/1000BASE-Tconnection rate and communication quality are not guaranteed for this TV.)			
USB	USB jack Type A*1			
IR Blaster	Mini jack (For connecting the IR Blaster cable)			
<b>Power and others</b>				
Power requirements	120 V AC, 60 Hz			
Power consumption				
in use	147 W	122 W	85 W	84 W
in DAM*2	56 Wh/d	34 Wh/d		27 Wh/d
in standby	less than 0.5 W			
Screen size (inches measured diagonally)	46 inches	40 inches	31.5 inches (32 class)	23.5 inches (24 class)
Display resolution	1,920 dots (horizontal) x 1,080 (vertical)			
Speaker				
Full range with speaker (mm)	45 x 130	45 x 130	45 x 130	34 x 105
(inches)	1 13/16 x 5 1/8	1 13/16 x 5 1/8	1 13/16 x 5 1/8	1 3/8 x 4 1/4
Dimensions				
with stand (mm)	1,087 x 694 x 298	954 x 619 x 298	766 x 511 x 194	571 x 381 x 190
(inches)	42 7/8 x 27 3/8 x 11 3/4	37 5/8 x 24 3/8 x 11 3/4	30 1/4 x 20 1/8 x 7 3/4	22 1/2 x 15 x 7 1/2
without stand (mm)	1,087 x 661 x 54	954 x 586 x 53	766 x 481 x 56	571 x 353 x 71
(inches)	42 7/8 x 26 1/8 x 2 1/4	37 5/8 x 23 1/8 x 2 1/8	30 1/4 x 19 x 2 1/4	22 1/2 x 14 x 2 7/8
wall-mount hole pattern (mm)	300 x 300	300 x 300	200 x 200	100 x 100
wall-mount screw size (mm)	M6 x 16	M6 x 16	M6 x 16	M4 x 12
Mass				
with stand (kg)/(lb.)	22.7/50.1	18.8/41.5	13.2/29.2	10.1/22.3
without stand (kg)/(lb.)	21/46.4	17.1/37.7	11.8/26.1	8.7/19.2
<b>Wireless</b>				
Wireless LAN standard	IEEE 802.11a/b/g/n			
Frequency range	2.4 GHz band: Channels 1-11 5 GHz band: Channels 36-64, 100-140, 149-165			
Modulation	DS-SS Modem and OFDM Modem			
<b>Accessories</b>				
Supplied accessories	Keypad (1) / Size AA batteries (2) / AC power cord (except NSX-24GT1) (1) / IR Blaster cable (1) / Table-Top Stand (1) / Screws (M4 x 10, for NSX-GT24)(3), Screws (M5 x 16, for NSX-32GT1/NSX-40GT1/NSX-46GT1)(3) / Cable cover (1) / Quick Setup Guide (1) / Reference Guide (1) / Table-Top Stand leaflet (1) / Attention (1) / End User License Agreement (1) / Warranty card (1)			
Optional accessories	Connecting cables / Wall mount bracket			

## Warning

This content is compiled from multiple sources and is provided for reference purposes only. It may not be complete or fully applicable to all situations. If you are unable to resolve your issue, please contact the product manufacturer or an authorized service provider for official support.

---

Document generated by [ManualsFile](#)

