

User Guide for Refrigerator

BEFORE YOU BEGIN

- Ensure the installer has completed the final checklist in the installation guide.
- Read this guide, taking special note of the safety and warnings section.
- Remove all packaging and dispose of it responsibly. Recycle items that you can.

Refrigerator compartment

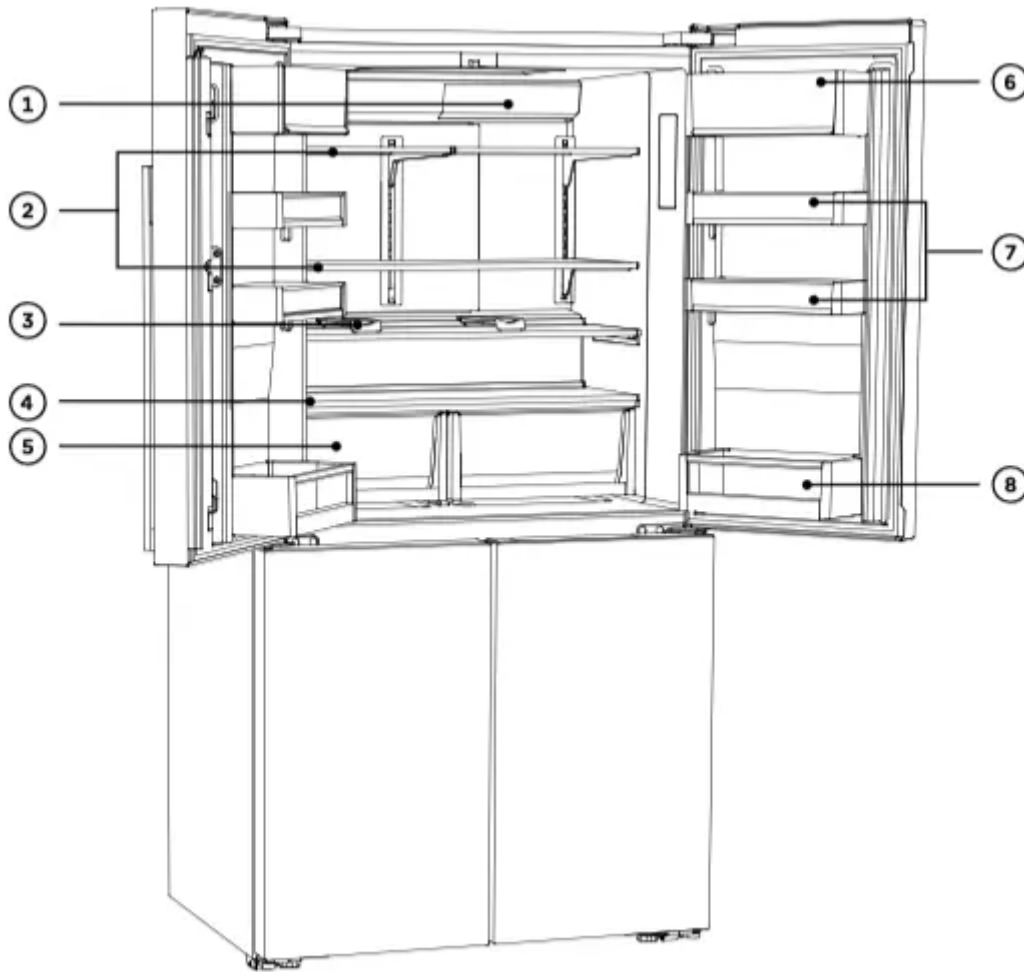

Refrigerator features

1. Water filter
2. Shelving
3. Bottle racks
4. Humidity control compartments
5. Bin

6. Dairy compartment

7. Door shelves

8. Gallon shelf

Freezer compartment

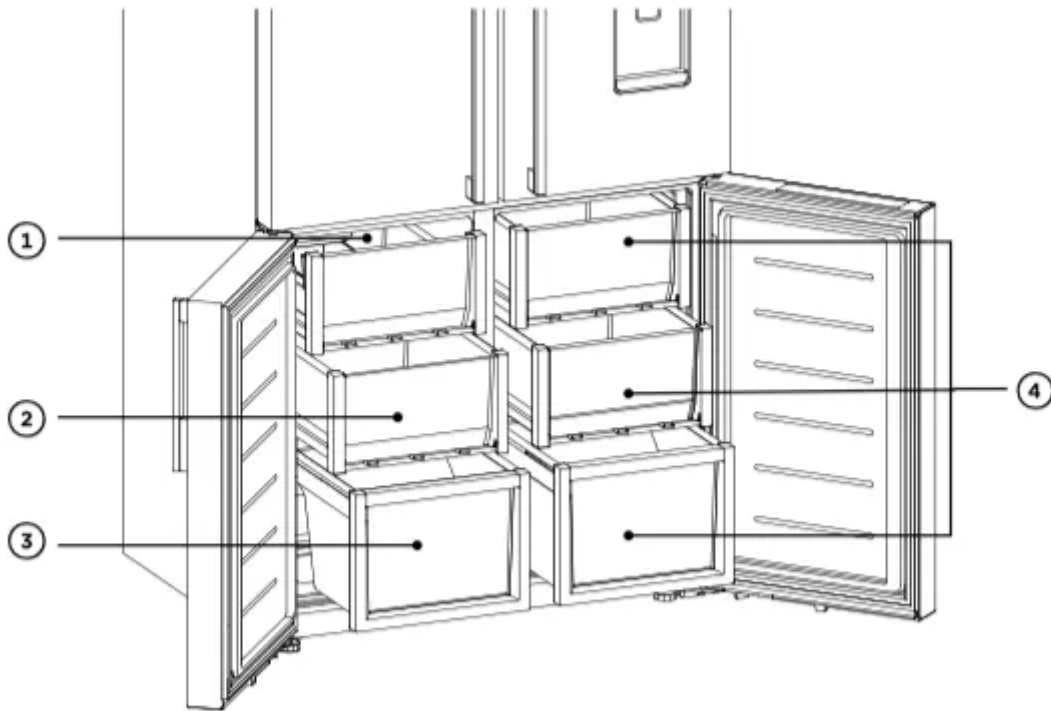

Freezer features

1. Ice storage bin with scoop

2. Mid bin

3. Large bottom bin

4 Variable Temperature Zone

USING THE CONTROL PANEL

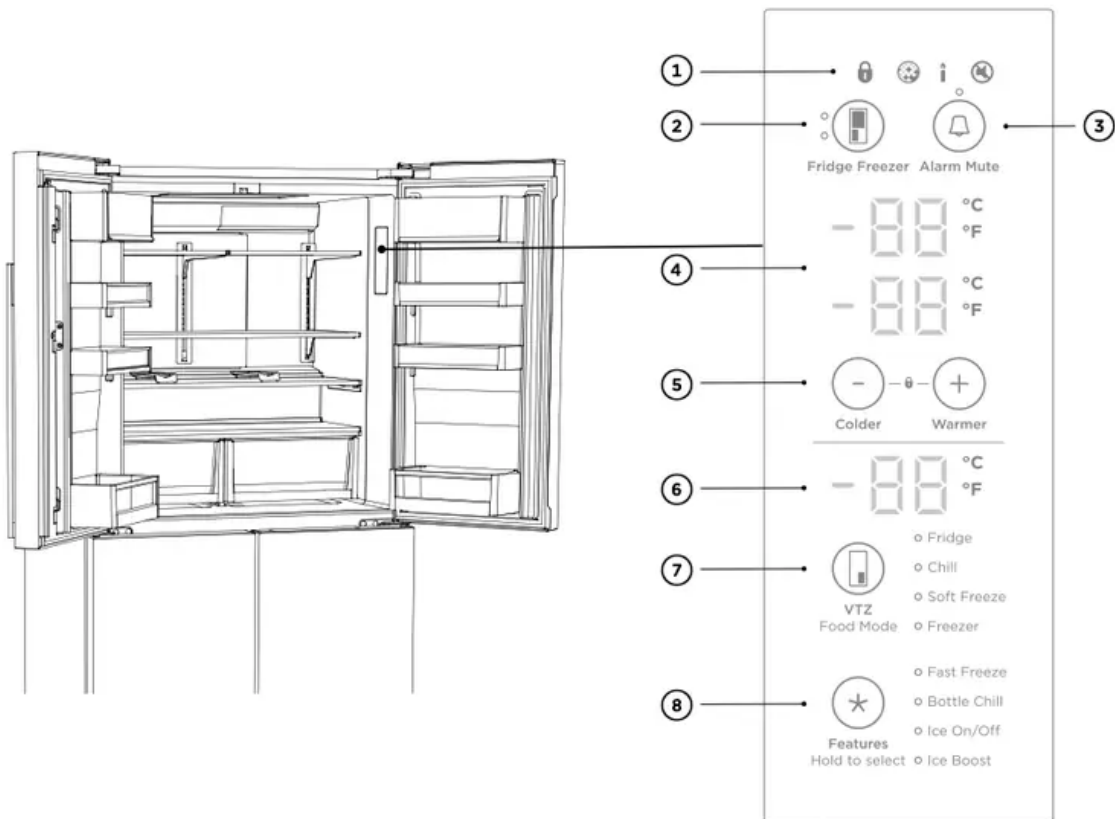

①  Illuminates to indicate that the keys on the control panel are locked. When the door is closed the display is automatically locked.

 Illuminates when the water filter needs replacing.

 Illuminates to indicate that Sabbath mode is activated.

 Illuminates to indicate key press sounds are deactivated.

②  Fridge/Freezer activates control panel when pressed. Allows you to select the fridge or freezer compartment to adjust the temperature.

- Upper light to indicate the refrigerator compartment is selected.
- Lower light to indicate the freezer compartment is selected.

③  Alarm mute deactivates the door alarm for 20 minutes.

④  Displays the set temperature of the Fridge/Freezer compartments.

To change between Celsius and Fahrenheit on the display: Press  for six seconds.

⑤ Allows you to adjust the temperature of the selected compartment.

⑥ Displays the set temperature of the Variable Temperature Zone.

To change between Celsius and Fahrenheit on the display: Press **+** for six seconds.

⑦ Allows you to select the food mode for the Variable Temperature Zone — FRIDGE, CHILL, SOFT FREEZE, FREEZER. Lights illuminate to indicate which food mode is selected.

⑧ Allows you to scroll and select features: FAST FREEZE, BOTTLE CHILL, ICE ON/OFF, ICE BOOST.

USING YOUR APPLIANCE

The images in this section are for reference only, your models control panel may differ slightly.

Temperature control

- When you turn your refrigerator on for the first time, the cooling system will automatically cool all compartments to their set temperatures within 2-3 hours.
- The internal control panel enables you to change and control the temperature of all compartments accurately and independently. The internal control panel default setting is to show the set temperature for the fresh food compartment.
- For common foodstuffs, the factory default setting provides the optimum setting for foodcare.

How to adjust the temperature — Fresh food compartment



- Press  once. The fresh food compartment light will illuminate.

2

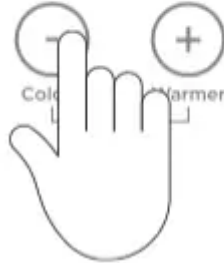

- Press **+** to increase the temperature, **-** to decrease the temperature.

How to adjust the temperature — Frozen food compartment

1



- Press  twice to adjust the frozen food compartment temperature. The frozen food compartment light will illuminate.

2

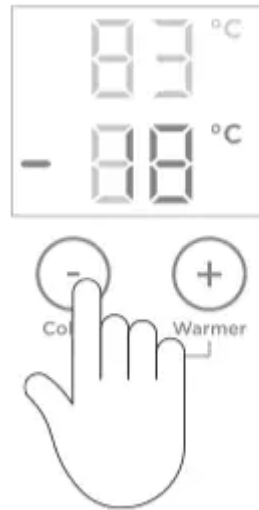

- Press **+** to increase the temperature, press **-** to decrease the temperature.

Door alarms



If the fresh food compartment door is left open, the alarm will beep after 90 seconds, if the freezer door is left open the alarm will beep after 60 seconds. If either of the doors remains open, subsequent beeps will sound every 30 seconds for five minutes.

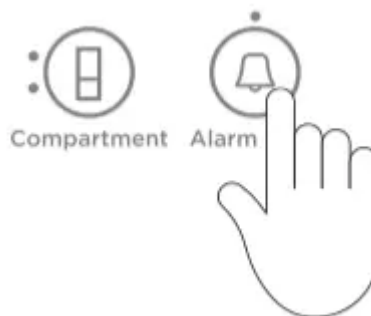

Alarm mute

1





- To activate/deactivate ALARM MUTE, press  once. The light above the  button will illuminate to indicate the refrigerator is muted.
- ALARM MUTE will automatically deactivate after 20 minutes or when the door is closed.

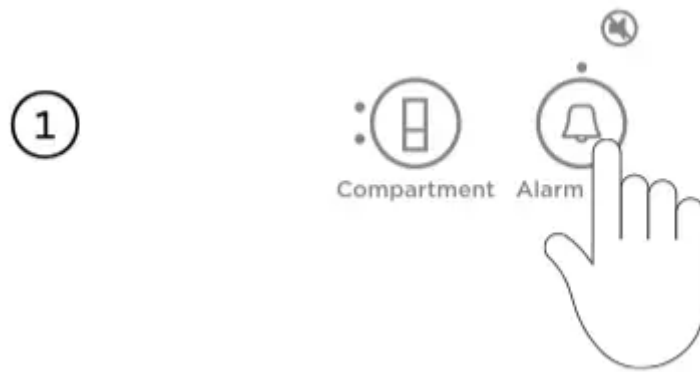

Key mute



- To activate/deactivate KEY MUTE, press  for four seconds.
- Once KEY MUTE is activated the  icon on the internal control panel illuminates, all key sounds are silenced.
- Door alarms and the BOTTLE CHILL alarm are still operational.

Key lock

- KEY LOCK allows you to disable the buttons on the internal control panel. This is useful when cleaning your refrigerator.

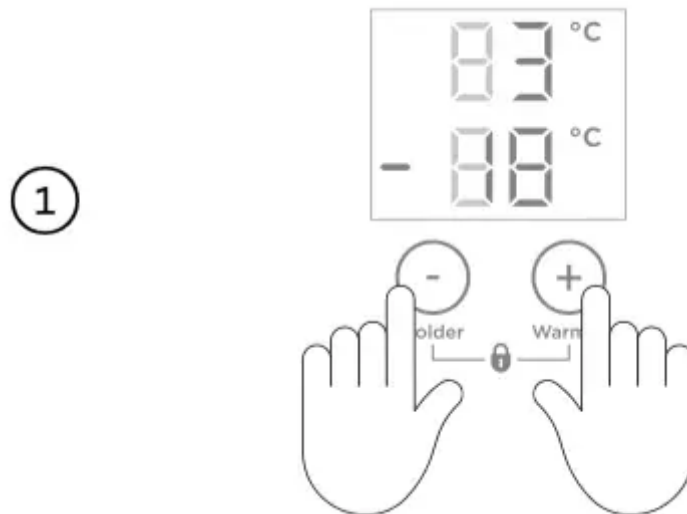

- To activate/deactivate KEY LOCK, press **+** and **-** together for four seconds.
- When KEY LOCK is activated the  icon on the internal control panel will illuminate. Pressing any of the buttons will sound several beeps to tell you that they are disabled.





Sabbath mode

In SABBATH MODE, alarms, lights and displays are deactivated for 80 hours.

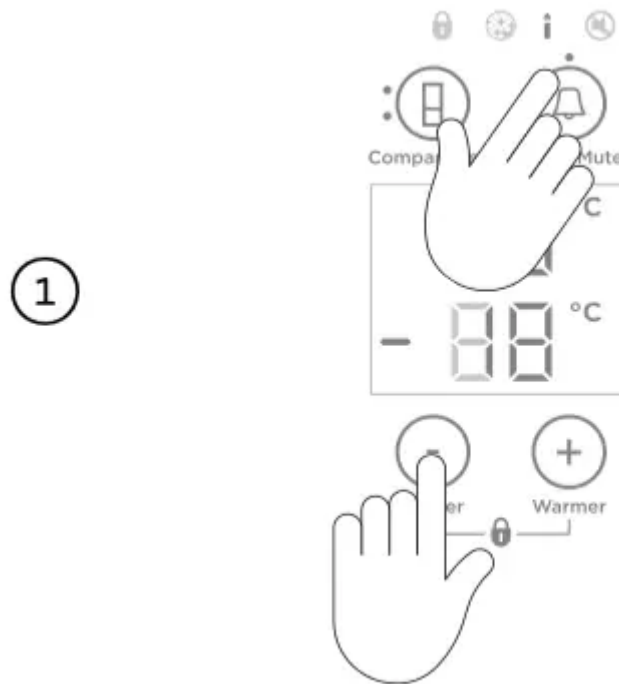
Once in Sabbath mode:

- The interior light will not turn on when you open the refrigerator.
- The door alarms will not operate.
- The display will not illuminate, except the Sabbath mode icon.
- The internal and external control panels will not operate.
- Sabbath mode automatically deactivates after 80 hours.



- To activate/deactivate SABBATH MODE, press  ,  and  together for four seconds. The  icon on the internal control panel will illuminate when SABBATH MODE is activated.
- If you turn off your refrigerator while in SABBATH MODE it will resume automatically once the refrigerator is switched on again.

Water-dispensing models only

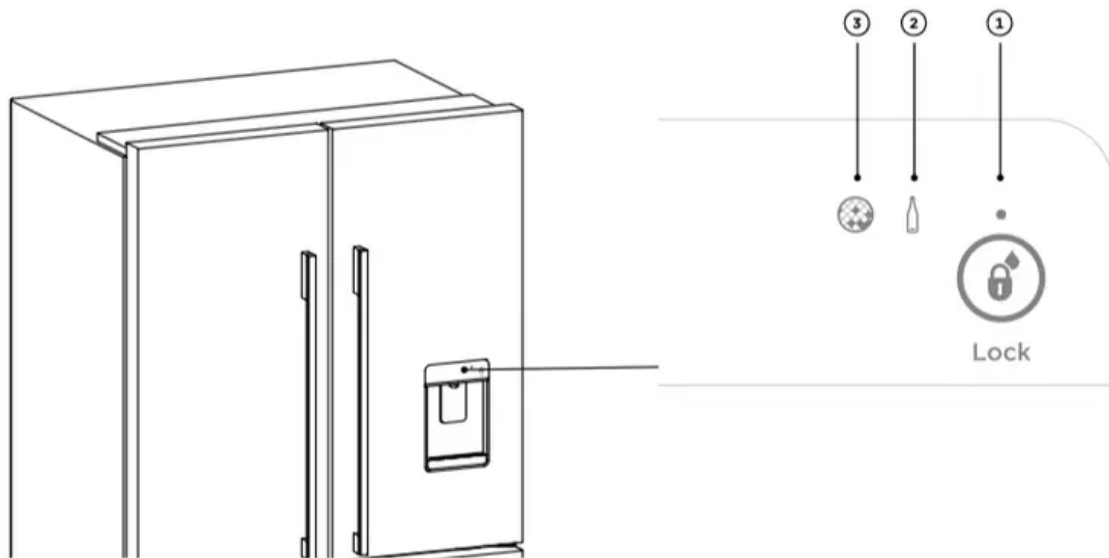

① Dispenser lock button and LED light	🔒 Locks/unlocks the water dispenser. The LED above the lock button will illuminate when dispenser is locked.
② Bottle Chill indicator	🍷 Icon will illuminate when BOTTLE CHILL is activated and flashes when the beverage is ready.
③ Filter change indicator	🌀 Icon will illuminate when water filter requires changing.

Using your water dispenser

- Ensure you have followed the steps outlined in your installation guide prior to your first use of the water dispenser.

Dispensing

Your water dispenser is designed for one-handed operation.



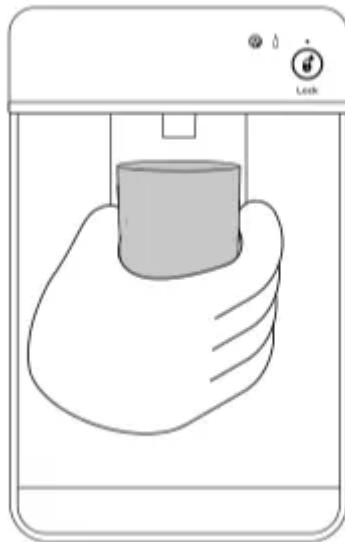



- To dispense water, gently press the dispensing pad with a glass or container.
- To stop the flow of water, simply pull your glass or container away from the dispensing pad.
- Pressing hard against the dispensing pad will not increase the flow or dispense more water.

Dispenser lock

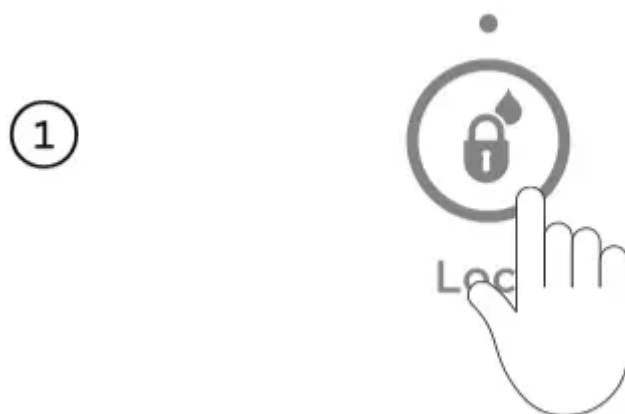
- The DISPENSER LOCK is located on the external display and can be activated to prevent water from being dispensed. This is useful when you are cleaning the external display or when there are small children around.



- To activate/deactivate DISPENSER LOCK, press  for four seconds.
- When activated the light above the button will illuminate.
- When the dispenser pad is pressed, several beeps will sound to alert the user that water cannot be dispensed.

Water filter

The water supplied to your refrigerator is filtered to remove impurities through a filter located internally at the top right corner of the refrigerator. Replace your filter cartridge every 6 months.

- There is a replacement indicator icon  on the internal control panel and external display which will appear when the filter needs replacing. The icon will flash, as a reminder, when water is dispensed.
- Replacement filter cartridges are available from your Fisher & Paykel dealer, online or from a Fisher & Paykel service technician. The details of the replacement filter cartridge are labelled on the cartridge.

Changing the water filter cartridge

- Guidance of how to replace your water filter and reset your indicator icon  can be found at [fisherpaykel/water-filter](https://fisherpaykel.com/water-filter).

Information about your ice maker

Your automatic ice maker will produce approximately eight cubes of ice every 3 – 4 hours, depending on the freezer compartment temperature and the number of door openings.

The ice cube tray will fill with water. When cubes are frozen, they will be ejected from the ice tray into the ice storage bin. Ice making will continue until the storage bin is full. Ice making will resume once you start to use the stored ice.

Your Ice & Water product comes with a smaller ice bin inside the larger freezer bin. Attached to the ice storage bin is the scoop for the ice. This scoop provides hygienic access to the ice. If a large amount of ice is required, remove an ice storage bin and allow ice to fall into the larger bin. For maximum ice storage, level the stored cubes with the ice scoop.

If ice is not used often, old cubes will become cloudy, taste stale, will shrink and may stick together. Empty the ice storage bin periodically and wash in lukewarm water. Dry thoroughly and place back into the correct position.

Turn your ice maker off if:

- There is no water supply for several hours.
- You are removing the ice storage bin for a period of time.
- You are going on holiday/vacation.

Manual ice system (where present)

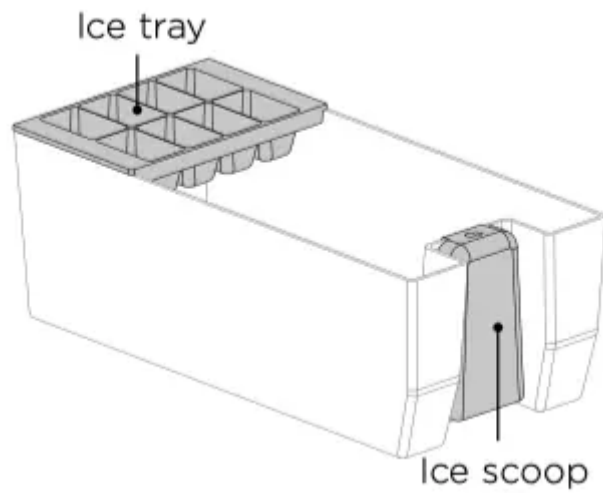

- An ice storage bin which sits inside the top freezer bin provides storage for and gives you access to clean, clear ice cubes. Attached to the ice storage bin is the ice scoop which provides hygienic access to ice.

To make ice

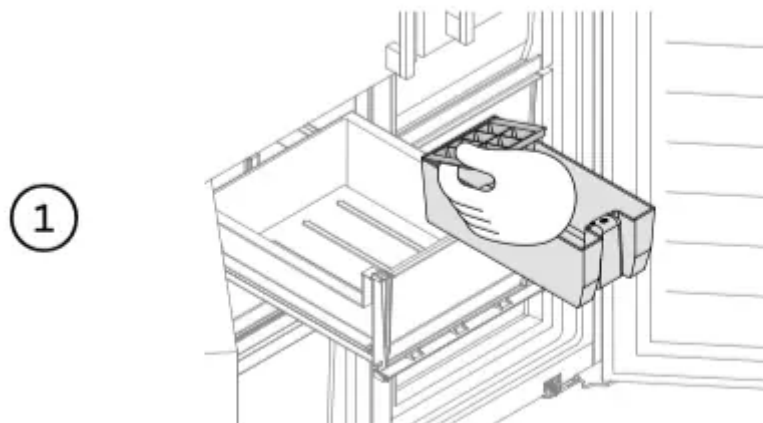

- Take the ice tray from the top of the ice storage bin. Fill the tray with water. Carefully position the tray back onto the ice storage bin.

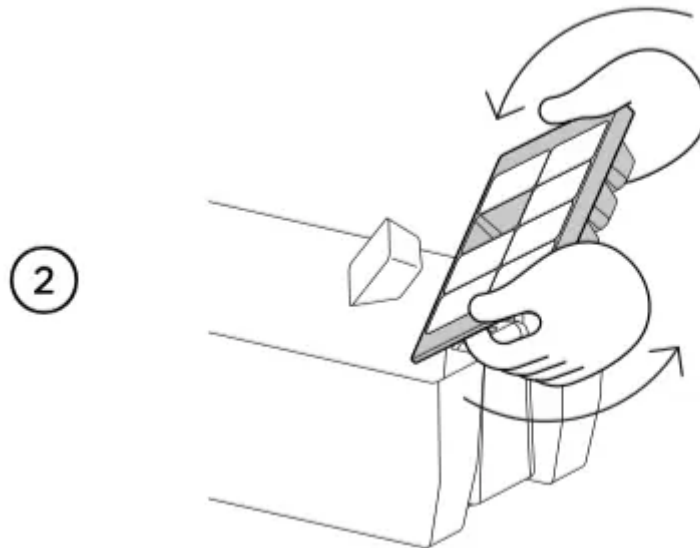

- Once the ice is solid, take the ice tray off the ice storage bin and twist the ice tray at each end in opposite directions. Turn the ice tray over the ice storage bin to dislodge the cubes into the bin.

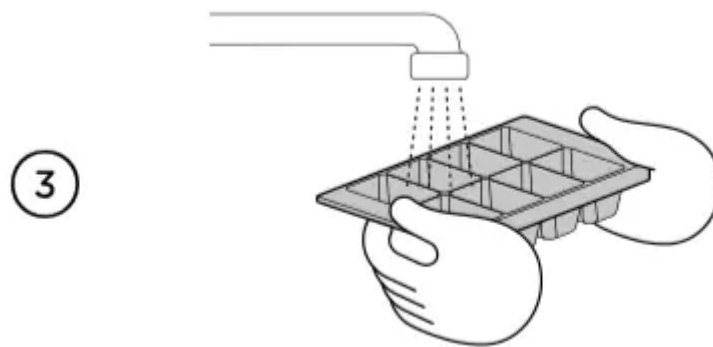

- Fill the ice tray with clean water and repeat to fill the ice storage bin.

Bottle holder

Bottle holders can be used to store a variety of bottles. Unused bottle holders can be stacked up on top of one another so they do not take up unnecessary shelf space. Bottles are best stored with the neck of the beverage facing the front of the refrigerator.

1

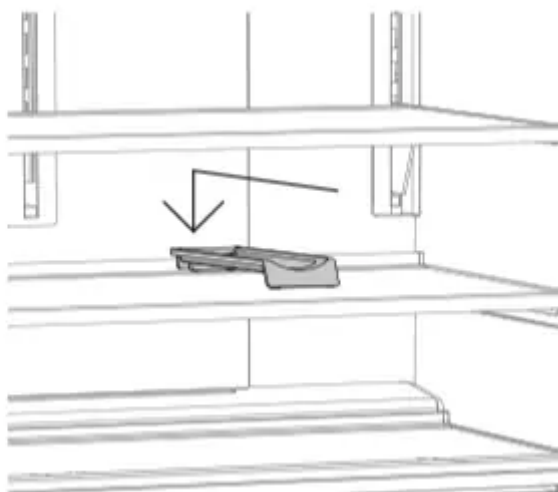

- To position the bottle holder in your refrigerator, slot the back edge of the bottle holder onto the back trim of any shelf in the fresh food compartment.

Glass shelves

- Standard glass shelves can not be repositioned in your refrigerator.
- The cantilever glass shelves are designed to be strong and versatile. The half-width and full-width shelves are removable and can be repositioned in your refrigerator.
- Some models have glass shelving under the freezer bins. These can be removed if required. Refer to 'Cleaning and care' for details on how to remove glass shelves.

Humidity control lids

- The control lids are fitted to the fruit and vegetable bins of your refrigerator.
- These lids provide a humid microclimate to extend the storage times of fruit and vegetables.
- The lids have specially designed grooves that retain moisture to prevent condensation from dripping onto the fruit and vegetables at times of high humidity.

Variable temperature zone

Changing the Food Mode

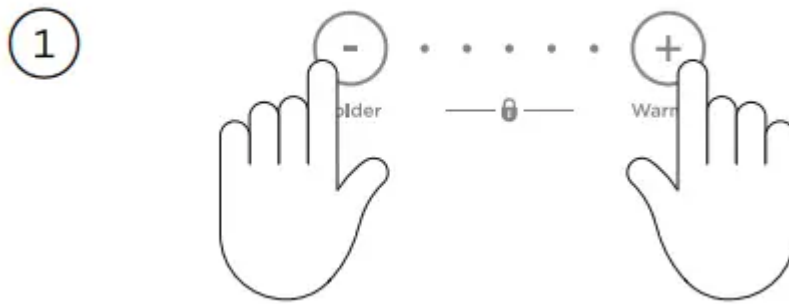

- Unlock the Variable Temperature Zone display by pressing **+** and **-** together for four seconds.



- Change the mode by pressing **➡**. FOOD MODE scrolls from left to right (coldest setting to warmest setting). The FOOD MODE selected will illuminate. The Variable Temperature Zone display will automatically lock after 10 seconds or once the compartment is closed.



- The default temperature for each FOOD MODE will show as one illuminated light in the centre of the scale.

Adjusting the temperature

Each FOOD MODE will automatically default to the recommended temperature setting for this food mode. Once you have selected the required FOOD MODE the temperature can be adjusted as desired.



- To increase the temperature of your selected FOOD MODE press **+**. Each light displayed will increase the temperature setting slightly. When all three lights on the right are showing this is the warmest setting.

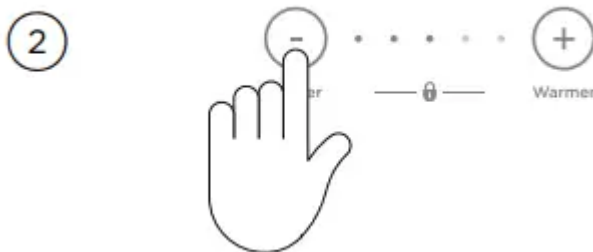

- To decrease the temperature of your selected FOOD MODE press **-**. Each light displayed will decrease the temperature setting slightly. When all three lights on the left are showing this is the coldest setting.
- If you adjust the temperature for a FOOD MODE this adjustment will be remembered for the next time you use this FOOD MODE. For example if you select FREEZER as the FOOD MODE and adjust the temperature to the coldest setting, the next time you use the compartment as freezer it will remember your setting.

Key Lock



- The Variable Temperature Zone display can be locked by pressing **+** and **-** together for three seconds. When locked, the icon  will illuminate.

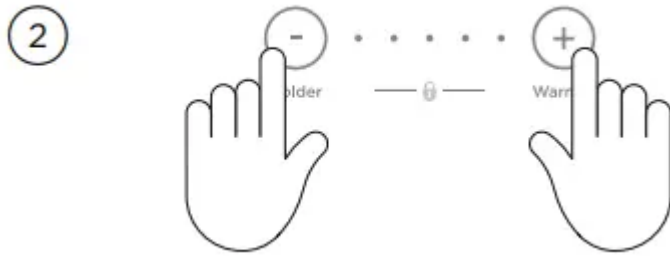



- Deactivate by pressing **+** and **-** together for four seconds

Features

Fast Freeze

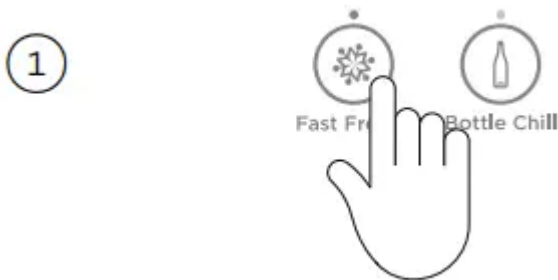
FAST FREEZE boosts freezing speed by dropping to its coldest temperature for 12 hours, helping retain freshness, texture and taste during the freezing process



- To activate, press  on the internal display. The FAST FREEZE light will illuminate.

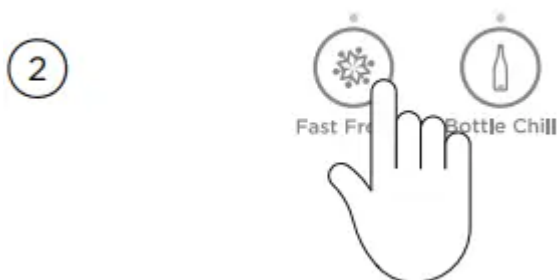



- To deactivate before the 12 hours has elapsed, press  again. When FAST FREEZE is deactivated the light is off.
- For best results activate the function before it is required. Alternatively, activate it when placing food into the freezer

Bottle Chill

BOTTLE CHILL rapidly chills your beverages in the freezer for a set time of 15 minutes. Depending on bottle size, you may need to return it to the freezer and reset



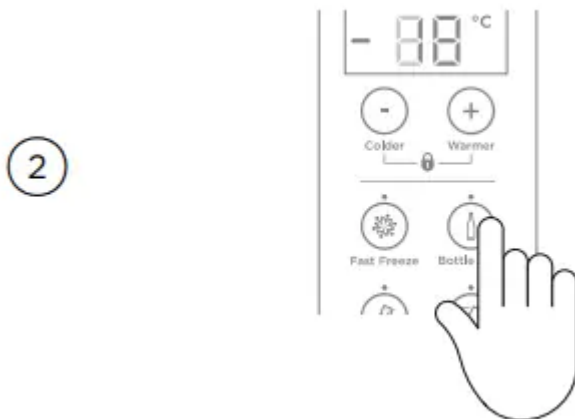

- To activate, press  on the control panel. The BOTTLE CHILL light will illuminate. The icon  will illuminate on the external display (Ice & Water models only).

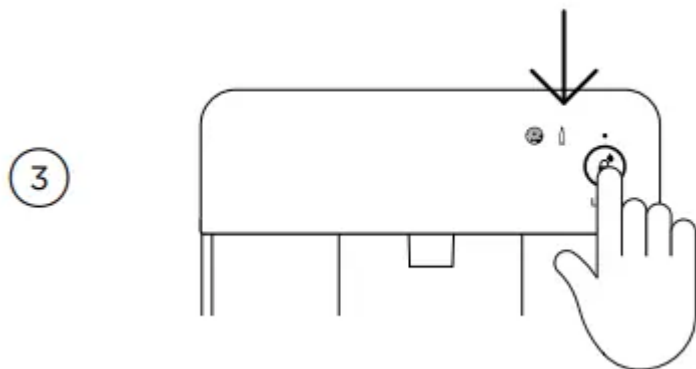

- An alarm will sound after 15 minutes to remind you to remove your beverage. For non water-dispensing models Open the fresh food compartment door and press any button on the control panel to silence the alarm.



- For water-dispensing models: The icon  will flash on the external display. Press  on the external display to silence the alarm.





- To deactivate BOTTLE CHILL before 15 minutes, press the  button on the control panel. When BOTTLE CHILL is deactivated, the light will not illuminate and the icon is not visible on the external display (Ice & Water model only)

IceOn/Off

ICE ON/OFF activates automatic ice - this is only available in the lower compartment.

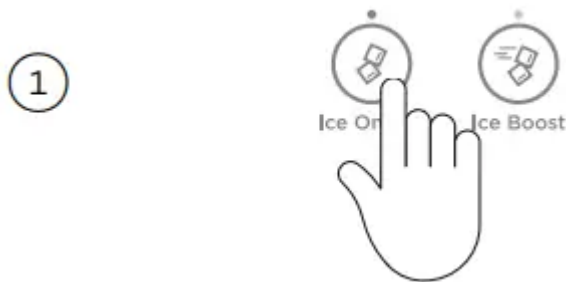

Your ice maker is designed to automatically dispense ice into the ice storage bin below until it detects the bin is full. The more ice you use, the more it makes. Before first use the automatic ice systems needs to be flushed.

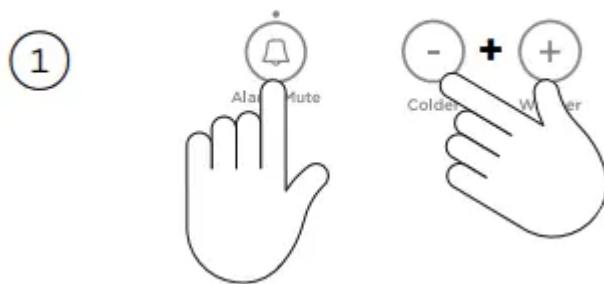

- To activate/deactivate, press .
- When the ice maker is activated the light will illuminate.

To flush the automatic icemaker





- Press and hold , , and  together for 4 seconds then close the door(s). The ice tray will flip twice and empty the water into the bin below. The ice tray will flip only after the doors are closed. Repeat the cycle to help remove any dust in the ice tray collected during manufacture and transport.
- Empty the water in the bin and return the bin correctly. Ensure that the scoop is located in front of the bin.
- Once your ice maker is turned on, discard the first 3 harvests of ice (8 cubes per harvest). This will flush away any impurities in the water line and ensure the best ice quality.
- Carrying out the above steps after a holiday/vacation or extended periods of not using ice.

Ice Boost

ICE BOOST increases ice production by up to 30% and will automatically deactivate after 24 hours.

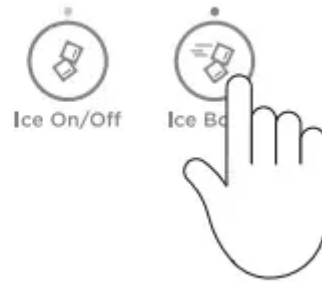
1



- When you first turn your ice maker on, ICE BOOST is off. To activate, press . The light above the  button will illuminate. ICE BOOST will pause once your ice bin is full.

2



- To manually deactivate press  again. The light will not illuminate. Activating ICE BOOST will automatically turn on ice making. Deactivating ice making automatically deactivates ICE BOOST.

Food modes

FREEZER MODE (-18°C)	<p>For general frozen food items that require storage between 1 – 12 months.</p>	<p>Meat, poultry, seafood, pre-cooked foods and leftovers, some fruits and vegetable, ice cream, and other frozen desserts.</p>
SOFT FREEZE MODE (-7°C)	<p>Allows easy portioning of food and the ability to heat, cook or serve foods straight from the compartment without waiting for it to thaw.</p>	<p>Meats, seafood, soups, sauces, pureed foods, bread, desserts and pastries.</p> <p>Not recommended for storage of creamy desserts such as ice cream.</p>
CHILL MODE (0°C)	<p>Is an extension of FRIDGE MODE providing the perfect storage zone for highly perishable food to ensure they retain their vital freshness and quality. These items will last slightly longer here compared with storage at FRIDGE MODE.</p>	<p>Highly perishable meats, poultry and seafood.</p> <p>Alcoholic beverages such as beer.</p>
FRIDGE MODE (3°C)	<p>The ideal mode for fresh foods such as fruit and vegetables, dairy products, meats and drinks.</p>	<p>Fruit and vegetables, dairy products, jams and chutneys/ preserves, meats and drinks.</p>

Changing the Food Mode

1



- Press the VTZ FOOD MODE  button. The digital display for the Fridge/Freezer compartment will not be illuminated. The FOOD MODE scrolls from top to bottom (warmest setting to coldest setting). The FOOD MODE selected will illuminate.
- The FOOD MODE will be activated once the control panel is locked.
- The Variable Temperature Zone display will automatically lock after 10 seconds or once the compartment is closed.

Adjusting the temperature

Each FOOD MODE will automatically default to the recommended temperature setting for this food mode, which is illuminated on the digital display. Once you have selected the required FOOD MODE the temperature can be adjusted as desired.

1



- To increase the temperature of your selected FOOD MODE press **+**.
- The digital display will change, at the warmest point pressing the **+** button again will sound the invalid button press melody and nothing will change.

2



- To decrease the temperature of your selected FOOD MODE press —.
- The digital display will change, at the coldest point pressing the — button again will sound the invalid button press melody and nothing will change.
- If you adjust the temperature for a FOOD MODE this adjustment will be remembered for the next time you use this FOOD MODE. For example if you select FREEZER as the FOOD MODE and adjust the temperature to the coldest setting, the next time you use the compartment as FREEZER it will remember your setting.

Features

Fast Freeze

FAST FREEZE boosts freezing speed by dropping to its coldest temperature for 12 hours, helping retain freshness, texture and taste during the freezing process.

1



- To activate, press the * button to scroll through the features to FAST FREEZE.
- The light next to the feature will flash.
- To select the feature, press the * button for two seconds until flashing light turns solid.

2



- To deactivate before the 12 hours has elapsed, press the button and scroll to FAST FREEZE.
- Press ★ button for two seconds.
- For best results activate the function before it is required. Alternatively, activate it when placing food into the freezer.

Bottle Chill

BOTTLE CHILL rapidly chills your beverages in the freezer for a set time of 15 minutes. Depending on bottle size, you may need to return it to the freezer and reset.



1



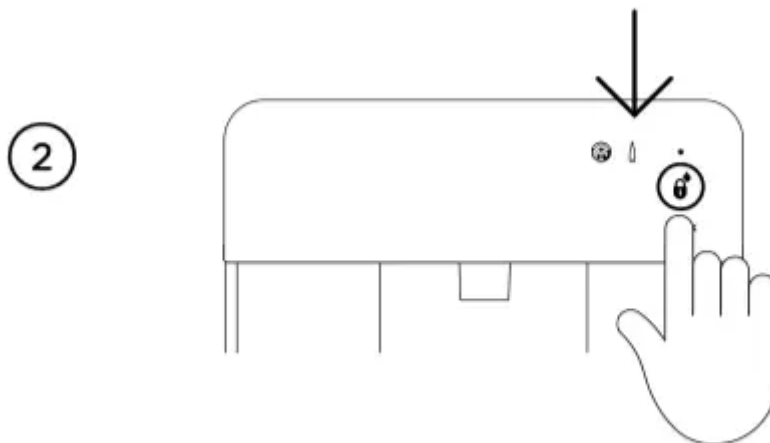

- To activate, press the ★ button, scroll to BOTTLE CHILL. The light next to the feature will flash.
- Press the ★ button for two seconds until the flashing light turns solid.
- An alarm will sound after 15 minutes to remind you to remove your beverage.



For water-dispensing models

- The  icon will flash on the external display. Press  on the external display to silence the alarm.



- To deactivate before the time has elapsed, press the  button, scroll to BOTTLE CHILL.
- Press  button for two seconds.
- When BOTTLE CHILL is deactivated the light will not illuminate.

Ice On/Off

ICE ON/OFF activates automatic ice - this is only available in the lower compartment.

Your ice maker is designed to automatically dispense ice into the ice storage bin below until it detects the bin is full. The more ice you use, the more it makes. Before first use the automatic ice systems needs to be flushed.

1



- To activate, press the ★ button, scroll to ICE ON/OFF. The light next to the feature will flash.
- Press the ★ button for two seconds until the light turns solid.



2

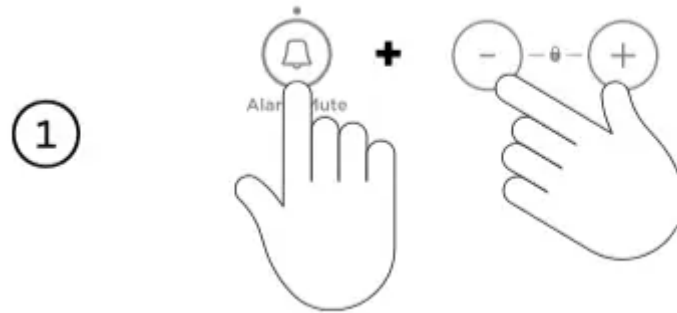

- To deactivate, press the ★ button, scroll to ICE ON/OFF.
- Press ★ button for two seconds.
- When ICE ON/OFF is deactivated the light will not illuminate.

To flush the automatic icemaker





- Press and hold ,  and  together for 4 seconds. The ice tray will flip twice and empty the water into the bin below. Repeat the cycle to help remove any dust in the ice tray collected during manufacture and transport.
- Empty the water in the bin and return the bin correctly. Ensure that the scoop is located in front of the bin.
- Once your ice maker is turned on, discard the first 3 harvests of ice (8 cubes per harvest). This will flush away any impurities in the water line and ensure the best ice quality.
- Carrying out the above steps after a holiday/vacation or extended periods of not using ice.

Ice Boost

ICE BOOST increases ice production by up to 30% and will automatically deactivate after 24 hours.



- To activate, press the  button, scroll to ICE BOOST. The light next to the feature will flash. Press the  button for two seconds until the light turns solid.

2



- To deactivate, press the ★ button, scroll to ICE BOOST. Press ★ button for two seconds. When ICE BOOST is deactivated the light will not illuminate. Deactivating ice making automatically deactivates the 'Ice Boost' function

CLEANING AND CARE

Exterior

- Clean all surfaces with liquid dishwashing detergent dissolved in warm water and a soft cloth. Rinse with clean water and dry with a clean, lint-free cloth.
- Do not use any abrasive stainless steel cleaners, glass cleaners, solvents or scourer pads as these will damage the door surface.
- For glass door products, clean the gap between the glass and the door or the handles with a toothbrush or small bottle/straw brush.

Door gasket

- Clean the magnetic door gasket every three months with a toothbrush, and liquid detergent dissolved in warm water.

Cabinet surround

- To maximise operating efficiency regularly vacuum the flooring around your refrigerator. Cleaning behind your refrigerator is required once or twice a year.

1

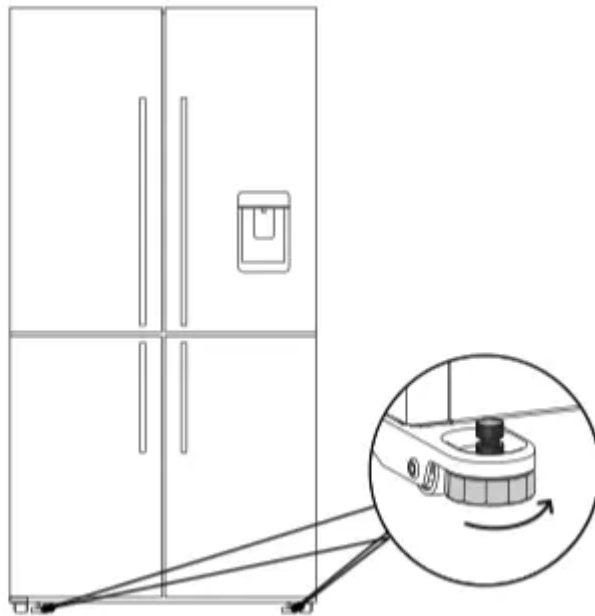

- Wind up the feet and carefully ease the refrigerator out of its position. Switch off and unplug.

2

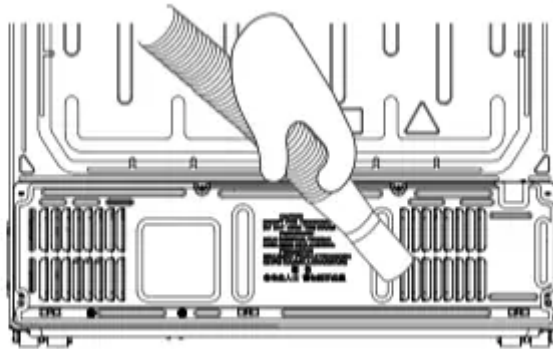

- Vacuum the flooring behind your refrigerator and the rear compartment cover (where fitted) to remove dust.
- Use a dry lint-free cloth to clean the refrigerator walls and surrounding cabinetry.
- After cleaning, plug in and switch on.
- Push the refrigerator into position and wind feet down.

External display and water dispenser (Water-dispensing models only)

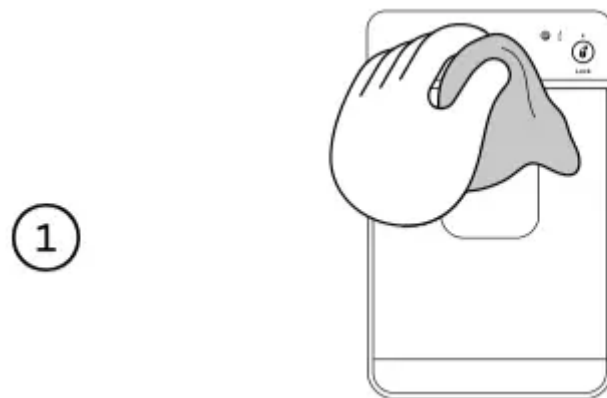

- Activate the DISPENSER LOCK to prevent water from dispensing when cleaning, refer 'Dispenser lock' section for details.
- Clean the pad and external display with a damp, soft lint-free cloth.

Drip tray (Water-dispensing models only)

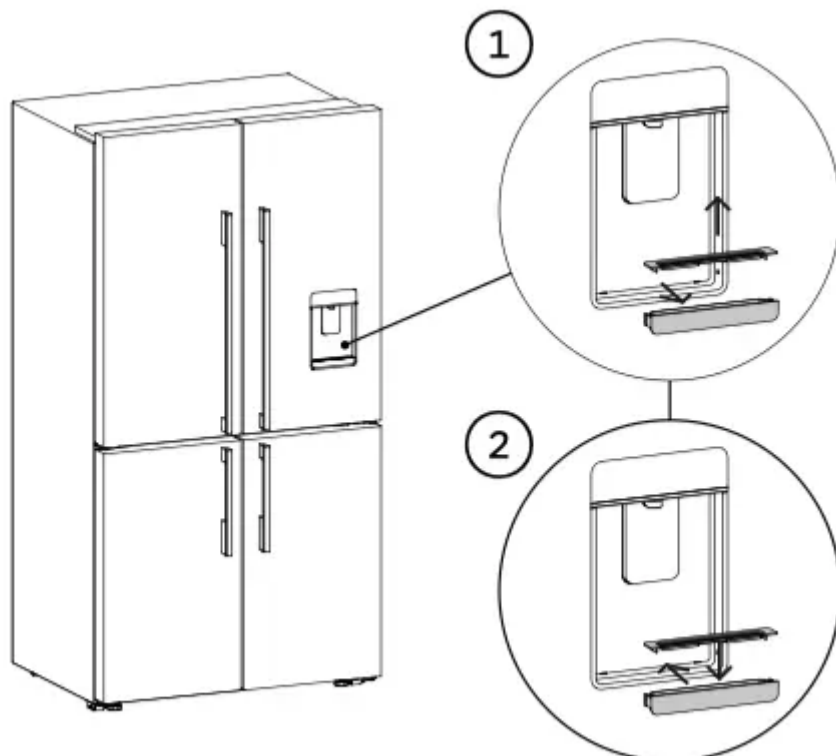

- Remove the drip tray from the dispenser panel.
- Pull the two halves of the tray apart.
- Clean with liquid detergent dissolved in water and a soft lint-free cloth.
- Rinse with clean water and dry with a clean, lint-free cloth.
- Securely clip the two halves together.

- Re-insert the drip tray back into the dispenser panel, rounded sides first.

Interior

- Do not use harsh chemicals, abrasives, ammonia, chlorine, bleach, concentrated detergents, solvents or abrasive scouring pads on any part of your refrigerator. Some of these chemicals may dissolve, damage and/or discolour the interior of your refrigerator.
- Remove the shelves from the cabinet and door. Wipe all interior surfaces, using only liquid dishwashing detergent dissolved in warm water or baking soda dissolved in warm water (add 1tsp of baking soda to every 500ml of water) and a soft lint-free cloth. Rinse with clean water and dry with a clean, lint-free cloth.
- Add a few drops of vanilla essence or vinegar to the water before cleaning to help remove “stale refrigerator” smell.

Glass shelves – Refrigerator

To remove

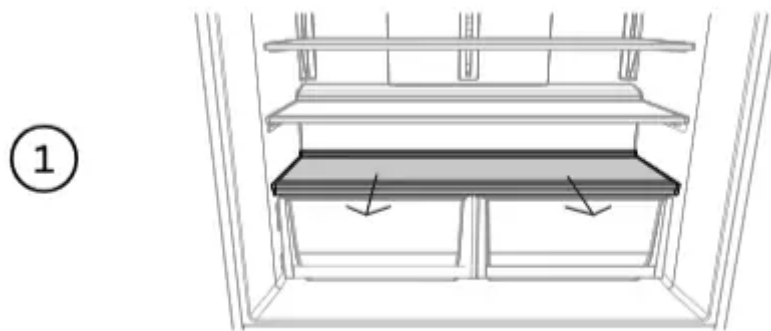

- Hold the shelf firmly and pull the shelf towards you.

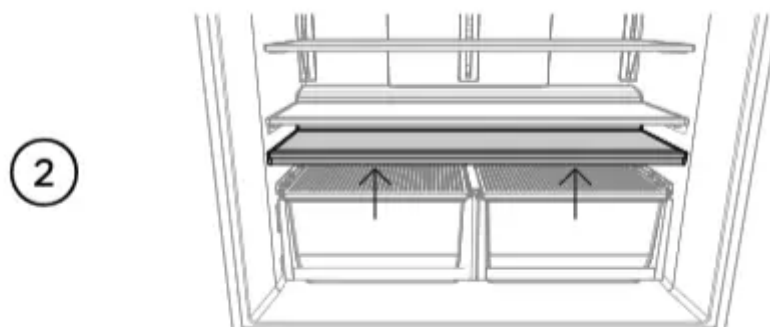

- Lift the shelf up vertically.

3

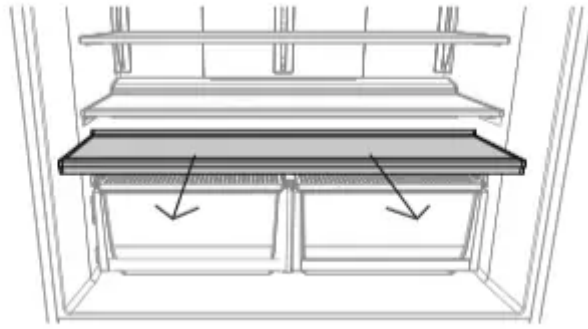

- Slide the shelf towards you.

Cantilever glass shelves — half-width and full-width

To remove

1

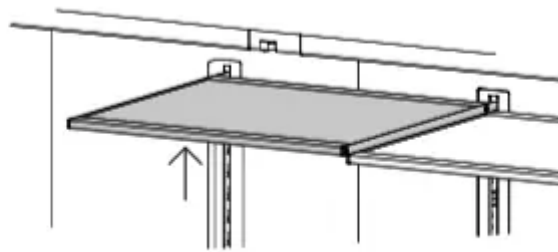

- Hold the front and back edge of the shelf firmly.
- Push the shelf up vertically to dislodge from back support lugs.

2

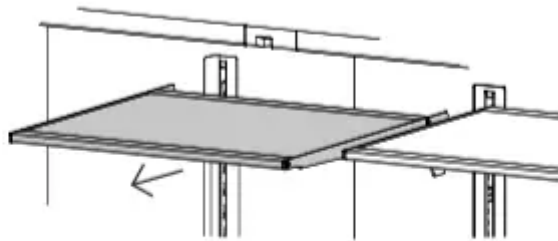

- Slide the shelf towards you.

Fixed bins and Freezer bins

To remove

①

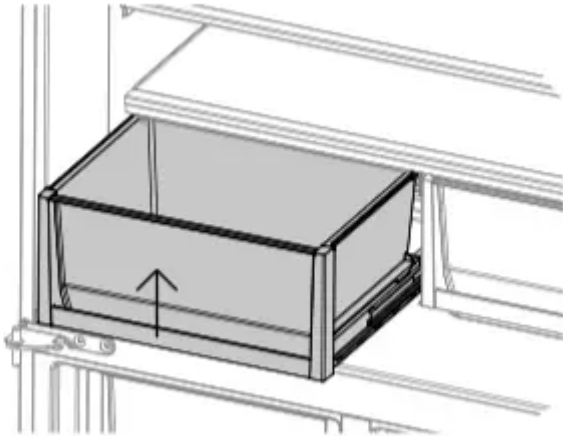

- Remove food from the bin.
- Hold the centre front of the bin handle. Lift vertically to unclip from the runners.

②

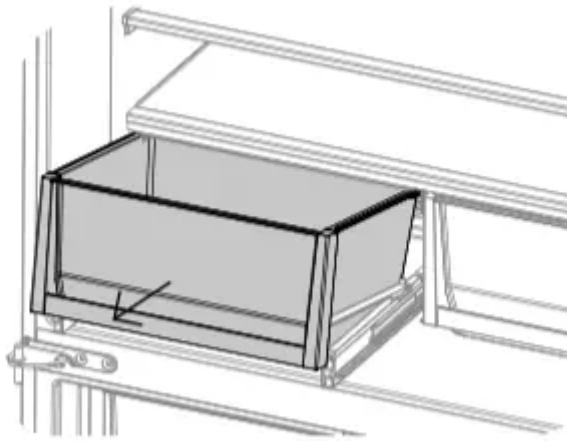

- Pull bin towards you to remove from the refrigerator.
- Push both runners back into the refrigerator.

How to replace

①

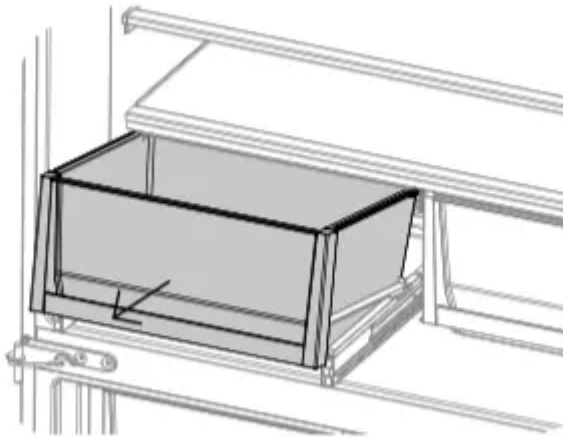

- Extend the runners out from the refrigerator. Place the bin on top of the runners.

②

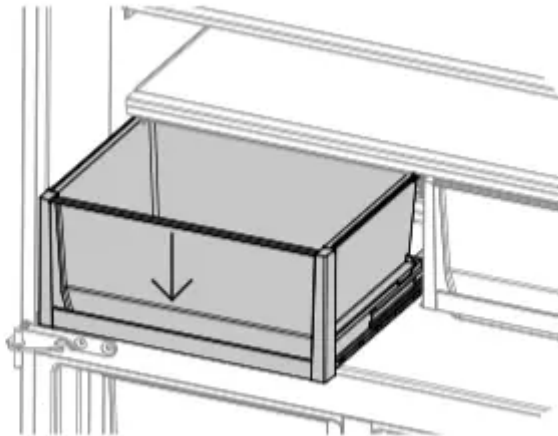

- Push the bin down slowly until you feel it clip.

Humidity control lid

To remove

①

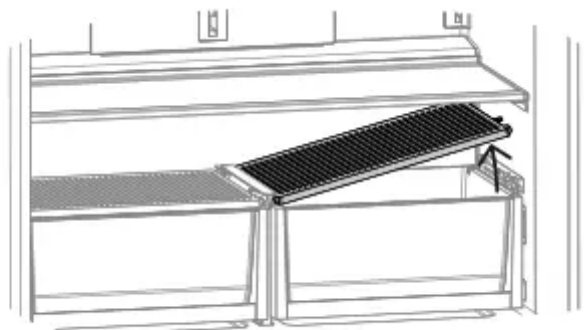

- Remove all shelving, follow the steps in section 'Glass shelving'.
- Hold the lid firmly and lift the outside edge of the lid up vertically.

2

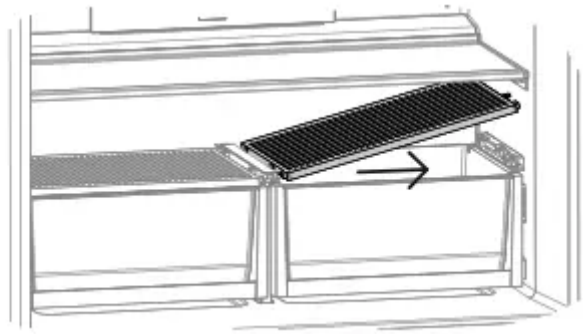

- Slide the lid towards the outside wall of the fridge until the lid unclips from the centre bracket.
- Pull the shelf towards you.

Support lugs

1

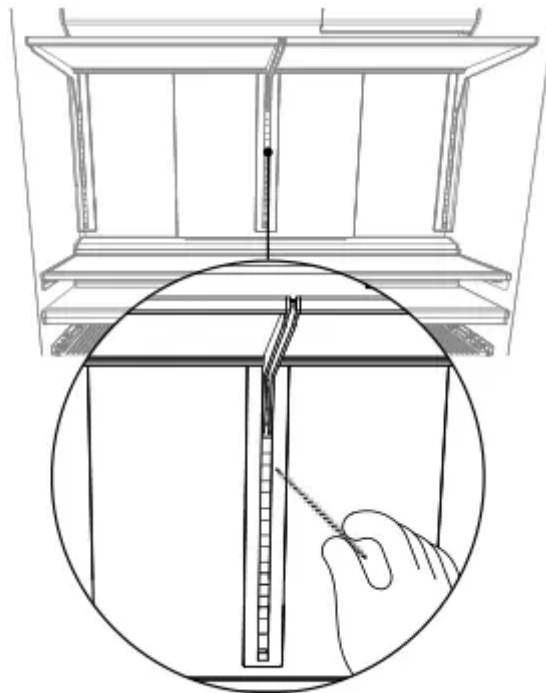

- Remove all shelving, follow the steps in section 'Glass shelves- Refrigerator'.
- Clean the support lugs with liquid detergent dissolved in water and a tube brush or a clean lint-free cloth.

Glass shelves - Freezer (if present)

To remove

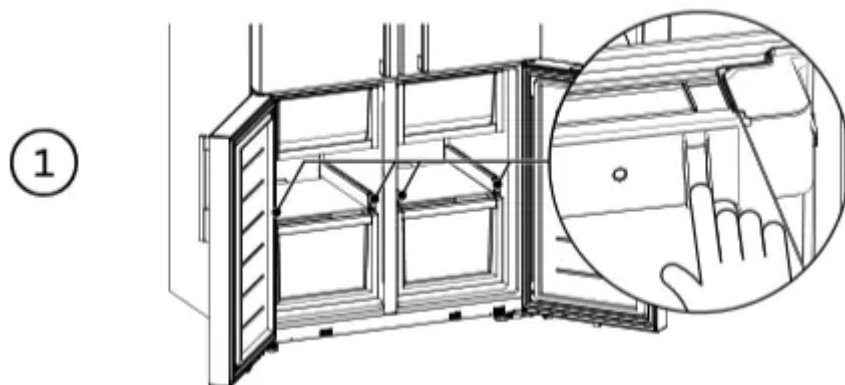

- Remove the bin above the glass shelf, refer to 'Fixed bins and Freezer bins'.
- Push on the clips on both sides of the shelf.

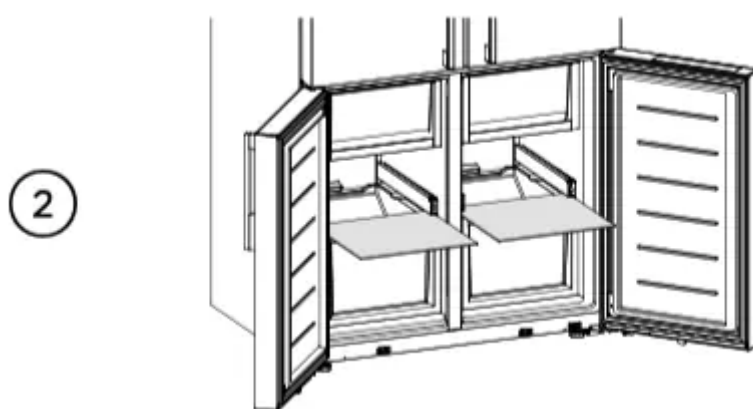

- Lift the shelf up to remove from the supports.

Ice storage bin

- Clean your ice bin and discard any old ice in the bottom of the bin(s) regularly. Ensure that the ice scoop is placed in correct position in the bin, right hand side or at the front of the bin (model dependent).

FOODCARE

For best food care

- Store only high-quality, fresh food in your refrigerator.
- Store perishable foods in the refrigerator immediately after purchase. Storing at room temperature increases the rate of deterioration and can allow harmful microbial growth. Foods such as meat, poultry and seafood should be well wrapped or sealed in suitable packaging to prevent dehydration, colour deterioration, loss of flavour, and transfer of odour.
- We recommend storing these foods on the bottom shelf of your refrigerator or in one of the bins to prevent potential spills and cross-contamination with other foods. Ensure hot

foods and beverages are cooled sufficiently before placing them into the refrigerator. Hot items may cause other foods to warm to unsafe temperatures. Hot items may also cause sealed items to sweat/condensate — which is undesirable. Beverages are best stored standing upright in the door shelves or on the bottle racks provided.

- Ensure raw and cooked foods are stored separately to avoid cross-contamination. Consume food items within the recommended storage times. Discard foods that show sign of spoilage.
- Keep door openings to a minimum to maintain optimum storage temperatures inside your refrigerator.
- We recommend using FAST FREEZE when you are adding food items to your refrigerator, such as after grocery shopping. This feature will ensure the food is frozen within the shortest period of time, locking in the freshness and extending the shelf life of your food. For storage of general household foods in the most efficient manner, it is recommended to use the product in the factory configuration supplied. Moving the shelves and bins will have a minimal impact on efficiency.
- Storing at temperatures other than settings recommended may impact the storage life.

Items stored in your refrigerator

- Dairy items such as butter and cheeses should be stored in the covered door shelf to minimise any transfer of odour or odour absorption from other foods.
- Eggs should be stored in their carton to avoid absorption of strong odours through their porous shell structure.

Items stored in your freezer

- We recommend cooling carbonated beverages only when the BOTTLE CHILL function is active.
 - Do not store carbonated drinks without this function in the freezer. Failure to remove beverages could lead to freezing liquid and the likelihood of bottle/can explosion.
- Ensure air is removed from packaging to avoid large formation of ice crystals and prevent freezer burn.
- To maintain freshness and quality, we recommend defrosting foods in the refrigerator. Ensure partially or fully defrosted foods are never re-frozen — cook immediately.

MOVING OR STORING YOUR APPLIANCE

If your refrigerator is turned off for any reason, wait 10 minutes before turning it back on. This will allow the refrigeration system pressures to equalise before restarting.

Moving your refrigerator

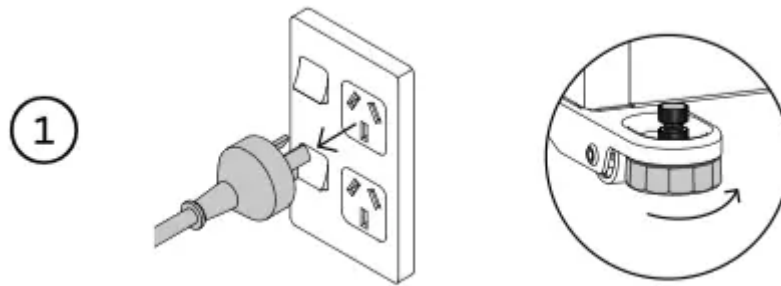

- Turn off the refrigerator and unplug from the power point. Remove all food.
- Turn the adjustable feet to the right as far as they will turn.

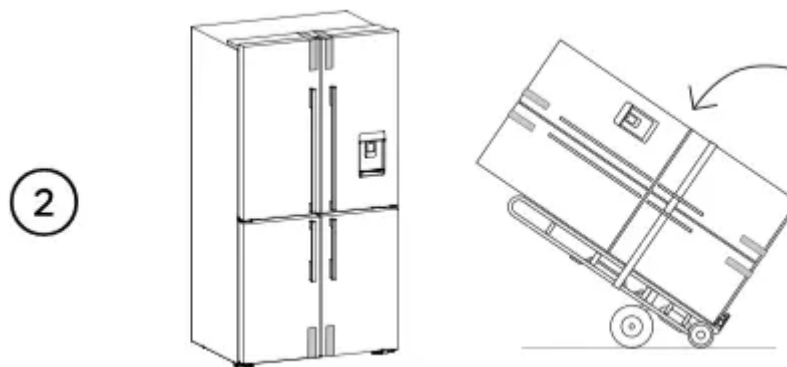

- Ease the refrigerator out of its position.
- Tuck the power cord away, tape the shelves in place and tape the doors closed. If the cabinet needs to be placed at an angle or laid down, carefully lay it on its side (the left hand side when viewed from the front).

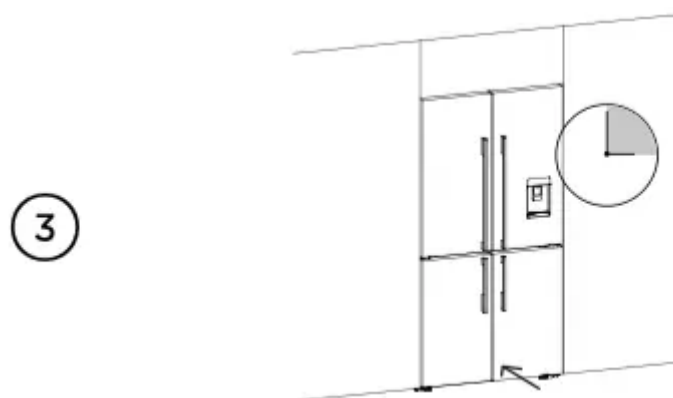

- Relocate and install. If the refrigerator has been left on its side for any length of time, leave it standing upright as long as you can (a few hours) before turning on.
- Take care when moving this refrigerator, ensure all obstacles are removed to prevent any physical impact that may cause damage.

Storing your Refrigerator

- When storing your cleaned refrigerator, leave the doors open. This allows air to circulate and prevents the build up of bacteria and moulds.
- Before using again, clean well using a mixture of warm water and a small amount of liquid dishwashing detergent. Rinse with clean water and dry with a soft lint-free cloth.

Holiday/Vacation time

Leave your refrigerator operating while you are on holiday/vacation.

ACTIVSMART™ SOUNDS

Normal refrigerator sounds

Your refrigerator is designed with innovative ActiveSmart™ features that can produce sounds that may be different from your old refrigerator.

Normal operational sounds include:

- Fan air flow sound. ActiveSmart™ refrigerators have fans which change speed depending on demand. During cooling periods, such as after frequent door openings, fans circulate the cold air in the refrigerator and freezer compartments producing some air flow sound. This is quite normal.
- Cracking or popping sound which may occur when the defrost function is operating. Running water sound. This is the liquid refrigerant in the system and can be heard as a boiling or gurgling noise.
- An audible hissing sound after closing the freezer door. This is due to the pressure difference between the warm air that has entered the cabinet and suddenly cooled, and the outside air pressure.
- Other sounds may be heard for the following reasons:
 - Cabinet not level.
 - Floor uneven or weak.
 - Bottles or jars rattling on shelves.
- If this is your first refrigerator with an ice maker, you will hear occasional sounds that may be unfamiliar. They are normal ice making sounds and are not cause for concern.
- The following sounds are normal with the operation of an ice maker:
 - Motor operation (low humming).
 - Running water as the ice maker and/or water tank fills.
 - Water valve opening and closing (hissing sound).

- Ice being loosened from the ice moulding tray (cracking).
- Ice dropping into bin (clunking).

TROUBLESHOOTING

If there is a problem with your refrigerator, please check the following points before contacting your local Fisher & Paykel trained and supported service technician or the Customer Care Centre.

Product parts and accessories can be purchased through Fisher & Paykel Customer Care Centre or online at fisherpaykel (this service is available to selected markets only).

All models

PROBLEM	POSSIBLE CAUSES	WHAT TO DO
Refrigerator does not operate	No electricity at power outlet.	Check that the plug is correctly connected and power switched on.
		Check another refrigerator at the same outlet.
		Check house fuse.
Light not working	Light not functioning.	The LED light cannot be serviced by the user. Contact your Fisher & Paykel Dealer or Fisher & Paykel trained and supported service technician.
	Refrigerator not working.	Check refrigerator is turned on at wall.
Light and display not working	Product in SABBATH MODE.	Press and hold  , + and - together for four seconds.
Motor operates for long periods	Hot weather.	Minimise door openings to allow temperature to stabilise.
	Frequent door openings.	
	Large amount of food recently added.	
	Temperature control set too low.	Refer to section 'Temperature control'.
	Doors not sealing properly.	Check that cabinet is level and gasket seals are clean.
Storage compartments too warm	Temperature setting not correct.	Refer to section 'Temperature control'.
	Frequent door openings.	Minimise door openings to allow temperature to stabilise.

	Large amount of food recently added.	
Food freezing in the refrigerator	Temperature setting not correct.	Refer to section 'Temperature control'.
	Food placed directly in front of air outlets.	Move chill sensitive foods away from the centre back of the shelves.
Unfamiliar noises	Cabinet not stable or level.	Refer to your Installation guide or 'ActiveSmart™ sounds'.
	Freezer is defrosting.	
Water in the vegetable bins	Condensation is formed by the water produced by fruit and vegetables.	A small amount of condensation is beneficial for fruit and vegetable storage.
		Wipe out water with a cloth.
Exterior of cabinet is warm	This is normal.	
Condensation on outside of refrigerator/ freezer	Not unusual during periods of high humidity.	Wipe dry.
Condensation inside fresh food compartment	Frequent or long door openings.	Minimise door openings.
	Door gasket leaking.	Check that gasket is sitting flat and sealing tightly.
	Not unusual during periods of high humidity.	Wipe dry.
Door out of alignment	With time and usage, movement may occur.	Refer to your installation guide.
Tray/bin does not slide in and out evenly	Packaging trapped.	Check to ensure no food or packaging is trapped behind the tray/bin.

	Runners not extending fully.	Holding onto sides of tray/ bin, extend the runners fully by using a firm pull — this will reset the runner.
Refrigerator operating inefficiently	Accumulation of dust on or behind the rear compartment cover.	Refer to section 'Cleaning and care'. If problem persists please contact Customer Care.
Cannot adjust temperature in frozen food compartment	Either BOTTLE CHILL, FAST FREEZE or ICE BOOST is activated.	Deactivate BOTTLE CHILL, FAST FREEZE or ICE BOOST if function is not desired.



Ice & Water models only



PROBLEM	POSSIBLE CAUSES	WHAT TO DO
Automatic ice maker does not work	Ice maker has not been turned on	Switch on ice maker.
	Bin is in the wrong way or there is no bin in place.	Place bin so scoop is on the left side.
		Ice bin sits directly under ice maker on top left side of freezer.
	Water supply turned off or not connected.	Connect water supply.
	Freezer compartment not working.	Contact Customer Care.
	Water pressure too low.	Check water pressure.
	Water line kinked/ squashed.	Check water line for kinks/ squashing.
	Filter clogged.	Water filter may need replacing.
Ice cubes have odour/ taste	Unsealed packages may be transmitting odour/taste.	Old cubes need to be discarded.
		Ensure food packaging is sealed.
	Interior of freezer needs cleaning.	Ice storage bin needs to be emptied and washed.
		Clean refrigerator.
	Poor taste from incoming water.	Filter may need to be replaced with new one.
	Force 2 – 3 ice tray flips.	
Slow ice cube freezing	Door may have been left ajar.	Close door.
	Freezer compartment too warm.	Turn temperature to a colder setting.

Wet ice/ ice clumping	Low water pressure.	Check water pressure.
	Filter blocked.	Replace filter.
	Long freezer door openings.	Gently tap ice with scoop to unstick or, if large clumps occur, empty ice bin and make new ice.
	High ambient temperature.	
	Ice bin left out of freezer compartment for a length of time.	
	Ice will stick together over time.	
Filter warning light  is flashing	Filter needs replacing.	Replace filter as soon as possible.
Ice build up inside freezer compartment	Freezer door not closing tightly.	Arrange items in freezer so door can close tightly.
		Check and clean door gasket seal.
Ice maker makes unfamiliar sounds or seems too loud	Normal ice maker operation.	Refer to section 'ActiveSmart™ sounds'.
Ice boost function not increasing rate of ice production	Ambient temperature very warm.	Minimise door openings.
	Refrigerator is in high usage.	
Water has poor taste/ odour	Refrigerator not used for an extended period.	Dispense 4L of water so fresh water supply is replenished.
	New filter installed.	
Water dispenser does not work	Water supply turned off or not connected.	Turn water on

		Press dispenser for four minutes to remove trapped air from water line and to fill the water system.
	Supply line may be blocked.	Check supply for kinks or leaks.
	On first installation there may be air in water system.	To remove air, run 3L of water through the dispenser.
	Filter may be blocked and need replacing.	Replace filter (see your 'Service & Warranty' document provided with your refrigerator).
	DISPENSER LOCK activated.	Press and hold  for four seconds.
	Water frozen in tank.	Increase temperature to a warmer setting in fresh food compartment and freezer.
Water in first glass is warm	Water dispenser not used for extended period.	Discard first glass of water dispensed.
	Tank capacity used recently.	Allow water time to cool.
Drips overflow drip-shelf	Air trapped in tank.	Flush 3L water through dispenser, stopping intermittently.
	New filter installed.	Dispense 4L of water through the dispenser, and then another 4L after four minutes.
Water flow rate has slowed down	Filter cartridge is restricted.	Replace filter as soon as possible.

Warning

This content is compiled from multiple sources and is provided for reference purposes only. It may not be complete or fully applicable to all situations. If you are unable to resolve your issue, please contact the product manufacturer or an authorized service provider for official support.

Document generated by [ManualsFile](#)

