

SereneLife

Portable SUP Air Inflator & Deflator (for SUP Stand-Up Paddle-Boards & Pool Inflatables)







I. PRODUCT INTRODUCTION

This product, SLPUMP50 is an intelligent DC electric pump with the preset pressure LCD screen, which can be used for inflatable tent, SUP, etc. Thanks to the intelligent pressure system, for example, if a pressure value is preset, when the pressure reaches the preset pressure value, the pump will automatically stop inflating.

This product also can deflation, and when the inflatable product is not used, you can use the air pump to empty the air inside for folding and storage.

II. LIST OF ACCESSORIES

Please make sure that the following accessories are in the box before using it, if any missing, please contact with the local service agents

| Air pump | Hose | User Manual | Charger |
|---|---|--|---|
|  |  |  |  |

III. DETAILS OF ACCESSORIES

1. Inflation inlet
2. Deflation outlet
3. DC plug
4. Pressure value LCD screen
5. USB 1A, 2A charging (output port
6. Charging input port
7. LED light button
8. Pressure unit toggle button
9. ON/OFF button
10. Decompressing button
11. Pressurizing button
12. Hose
13. Air tap
14. Charger
15. DC plug storage place
16. Flexible conduit adaptor
17. LED light

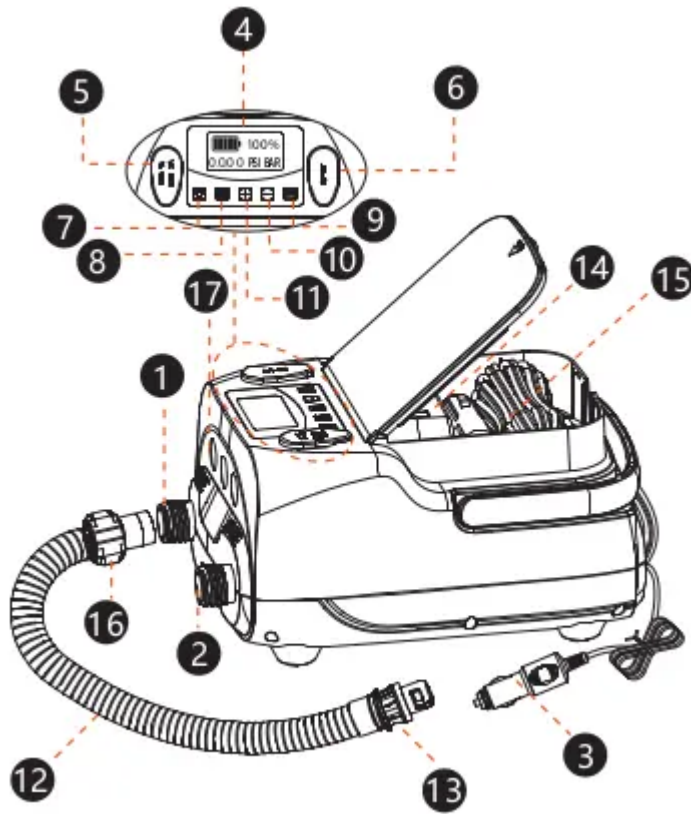

IV. SAFETY INSTRUCTIONS

In order to reduce the risk of injury, please keep children away from it. Always supervise children and incapacitated person contacting or using this air pump.

+ Children shall be kept far away from this product and wire.

+ This product is not applicable for the person with declining physical strength, sensory ability or mental capacity, the person lack of skill and the mentally retarded person, unless they are under the protection of their guardians, supervised and directed at the same time.

+ Before moving, maintaining, repairing or adjusting this product, please first pull out the DC plug from the socket.

+ Please do not bury the wire in the soil, and it should be placed in a safe zone where it won't be damaged by mower or other equipment.

+ If the power wire is damaged, the power wire must be changed by the manufacturer or its service agent or the similar authorized personnel, in case of any risk.

+ If you are standing in a place with water or your hands are wet, please don't plug or pull the DC plug.

- + Before inflating, please pay attention to check the maximum bearable pressure of the inflatable product, because the air bag may be damaged upon exceeding the maximum bearable pressure.
- + Before using, please check the cigarette lighter socket to make sure that there is no rust or residue inside. The cigarette lighter socket with poor electric conduction may cause overheating.
- + It is strictly forbidden to place the product in a high-humidity environment, otherwise the internal circuit of the product might be short-circuited, causing serious damage to the product.
- + Do not throw this product into fire which may result in explosion, battery leakage or other dangers.
- + Do not disassemble or break the product randomly for fear of damaging the product.
- + Avoid keeping or using this product under strong sunlight. Prolonged sun exposure will damage the performance of the product, resulting in overheating and line problems.
- + Do not use or store this product in an environment where the temperature is too low or too high, which might trigger automatic protection of the product and cut off the charging of the digital product.
- + Please use this product in a relatively safe environment, and keep it away from flammable/explosive liquids, gases or explosives.
- + Before charging this product, please verify that the specifications of the adapter match the product. Incompatible adapters might cause damage to the product or cause risky overload.
- + When the product is not in use, please put it in a dry and ventilated place, and prevent it from colliding with metal objects for fear of short circuit. Please pay attention to heat dissipation and ventilation during use, so as to avoid danger due to excessive temperature.
- + If the product is swelling or leakage is found, please stop using this product.
- + Do not disassemble the device without authorization. This product does not contain spare parts that can be disassembled/maintained by the user.
- + Do not cover or obstruct the product with paper or other objects for fear of affecting heat dissipation and cooling of the product.
- + In order to avoid injury or property damage, unplug the power cord when not using the product.
- + If leakage occurs and the liquid splashes into the eyes accidentally, do not rub your eyes but rinse your eyes with clean water immediately instead. If the symptom is serious, please consult your doctor.

+ Before using, please check the cigarette lighter socket to make sure that there is no rust or residue inside. The cigarette lighter socket with poor electric conduction may cause overheating of the product or power source, which will damage the product.

The purpose of using this product is limited to the description in the User Manual.

V. USB CHARGING OUTPUT OPERATION

In stand-by or power-on state, connect one end of the data cable to the mobile phone, and the other end to the USB 1A or 2A output port of this product to charge the digital product, as shown in Figure 1.

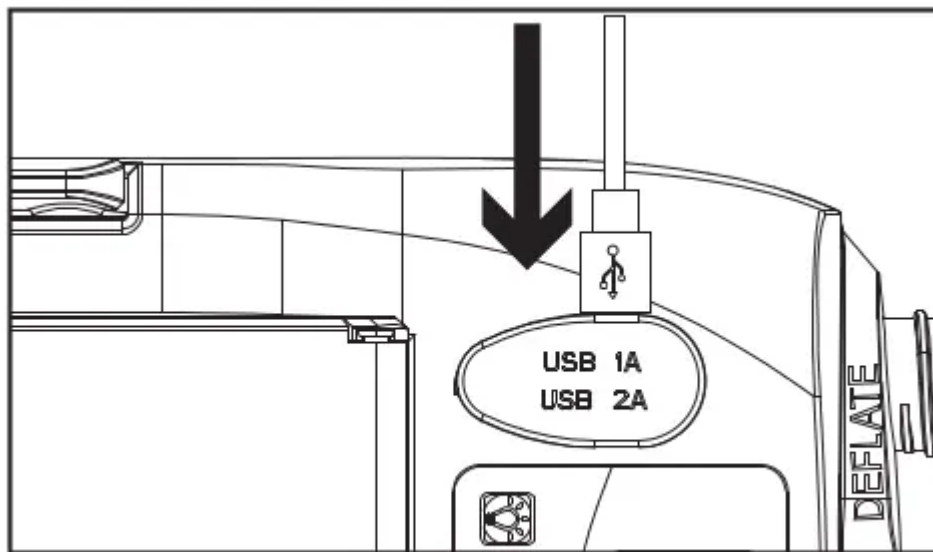

Figure 1

VI. CHARGING USING THE CIGARETTE LIGHTER PLUG/ADAPTER

In the stand-by or power-on state, take out the cigarette lighter plug and insert it into the DC12V cigarette lighter socket of the car or ship to charge or power the product, as shown in Figures 2 and 3.

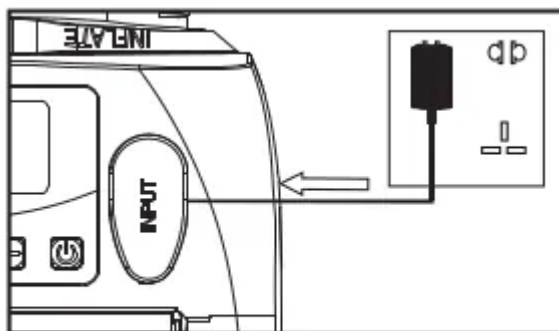

Figure 2

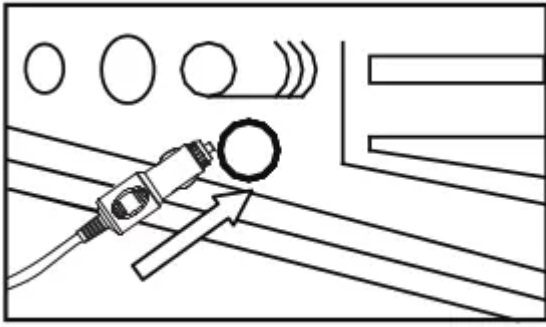



Figure 3

VII. INFLATION OPERATION

+ Press and hold the switch for 3 seconds to enter standby state.

+ Connect the end with flexible conduit adaptor (5) of the hose with the air pump inflation inlet (5). and twist clockwise to tighten it. as Figure 5.



+ Connect the other end of the hose with the air nozzle that matches the air bag. and insert the inflation valve of the air bag. Turn it clockwise to fix it as shown in Figure 6.

+ Press the pressure unit switching  button unit you need.

+ Press the pressure increase (+) button or pressure reduction button (-) to set the desired pressure value. The pressure range is from 0 to 16 PSI (1 PSI = 0.0689 bar = 6.89KPA).

Upon the completion of the above steps. press the power on/off button to start inflation.

+ In the process of inflation. you can press the pressure increase button (+) or the pressure reduction button (-) to increase or decrease the pressure value.

+ Press the pressure unit switching button  to switch between the units. and press the power on/off  button to stop.

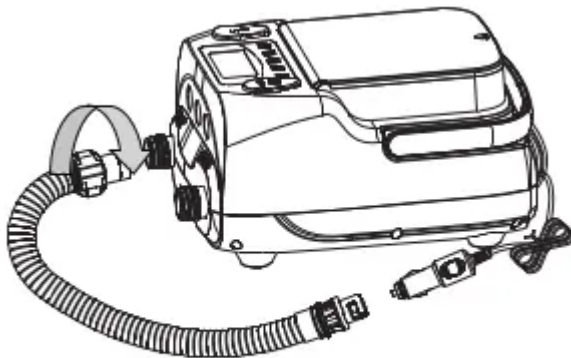

Figure 5

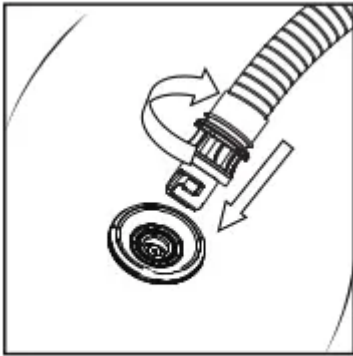

Figure 6

- + When the pressure reaches the set value. the air pump will stop working automatically.
- + Upon the completion of inflation. it will turn off automatically without other operations within 2 minutes.
- + After pulling out the DC plug. please take down the hose from the air pump and air bag and store it.

Notice: The factory set pressure value of the air pump is 10PSI (10PSI=0.689BAR). and at the time of the secondary use. the set pressure value for the last time use will be displayed by default.

- + Notice: After powered on. if there is no operation within 2 minutes. the air pump will enter standby mode. and the machine can be initiated by pressing the power switch button.

VIII. DEFLATION OPERATION

- + Remove the hose from the inflation inlet. Connect the end with flexible conduit adaptor (6) of the hose with the air pump deflation outlet (7). and twist clockwise to tighten it. as Figure 3.and the other end shall still be to the airbag.

Press the button of the power switch of air pump. and start the deflation until all the gas is discharged. then the power can be turned off to stop the deflation.

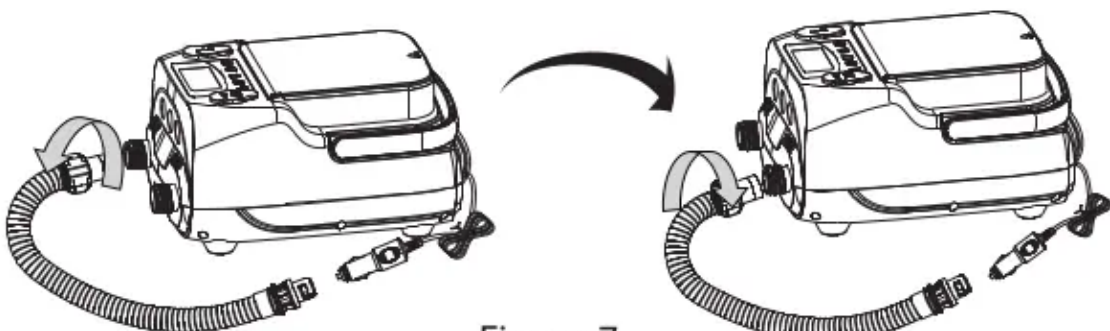

Figure 7

IX. PRECAUTIONS

- + As this product has a lithium battery. it can work using the battery. or the plug of the product can be inserted into the cigarette lighter socket on the car for use.
- + The applied power source must be the 12V DC power source (as Figure 8).
- + Do not block the inflation inlet (1) and Deflation outlet (2). and ensure that the inflation inlet (1) and Deflation outlet (2) shall remain smooth at all times.
- + Observe the local waste treatment provisions. and it is not allowed to throw the air pump away randomly.
- + Don't use this product when the hose is damaged. and please change the hose immediately.
- + Don't pull out the hose when inflating. because that the high pressure may hurt the physical body.
- + Don't make the air pump work for more than 30 minutes. because that motor overheating may cause internal damage; and the air pump shall be fully cooled for 30 minutes after continuously working up to 30 minutes.
- + Please don't use this air pump if any part is damaged. and contact with the professional personnel to repair it.

This product shall not be exposed to the rain or immersed in water.

- + In order to prevent risk. the inflation inlet shall not be forward to face or — body.
- + Please don't not leave while inflating.

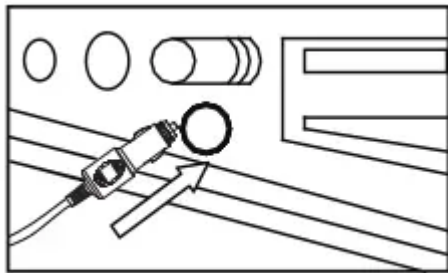

Figure 8

X. FAULT HANDLING

Fault: The air pump won't start normally

Inspection:

1. The power source is not plugged properly.
2. Low battery charge

3. Overheating or over load causes motor stop.

Solution:

1. Make sure that the power wire is plugged in the 12V DC socket
2. Charging.
3. Cool the motor and restart it.
4. If the problem cannot be solved. please contact local service agents or similar authorized personnel to change the product

Fault: Slow or abnormal inflation or deflation.

Inspection:

1. Check whether the hose is blocked or cracked.
2. The joint between the hose and air pump or air bag is not installed properly.

Solution:

1. Change the hose or make it unblocked. and check whether the hose is cracked.
2. Reinstall the hose.
3. If the problem cannot be solved. please contact local service agents or similar authorized personnel to change the product.

XI. MAINTENANCE AND STORAGE

+ After using. or if you want to move. maintain or adjust the product. please first pull out the DC plug from the socket.

+ When idle. it shall be properly stored after being fully cooled. It shall not be exposed to the rain or immersed in water.

+ Please store it in the dry and ventilated place.

XII. SUGGESTIONS

The warranty period of this product is one year. and it is suggested to use the original accessories. For any fault not caused by using the original accessories. it shall be out of the warranty scope.



SLPUMP50 - Electric SUP Air Pump Compresso Portable SUP Air Inflator & Deflator (for SUP Stand-Up Paddle-Boards & Pool Inflatables)

Features:

- + SUP Air Pump Inflator Deflator System



- + Smart Inflator Design with Air Pressure Preset
- + Ability to Set a Target PSI Pressure Level
- + Deflation Mode Quickly Removes Air
- + Simple Electric-Plugin Design
- + Digital LCD Display Screen
- + Touch Button Control Panel
- + Adjustable PSI Air Pressure Settings
- + Can be Powered via Integrated Car Cigarette Plug Power Cable
- + Built-in Rechargeable Battery
- + Button Activated LED Flashlight
- + Housing Access Lid to Store Power Cable
- + Convenient Carry Handle for Portability
- + Maneuverable Long Flexible Air Hose
- + Used for SUP Stand-Up Paddle-Boards & Backyard Pool Inflatables

What's in the Box:

- + SUP Air Pump Inflator
- + Detachable Air Hose
- + Wall Power Adapter
- + Storage / Travel Bag

Technical Specs:

- + Power Output: 110 Watt
- + Selectable Pressure Units: PSI / Bar
- + Adjustable Air Pressure: 0-16 PSI (Up to 1.10 Bar)
- + Air Hose Length: 3.3 ft.
- + Car Cig Power Cable Length: 9.8 ft.
- + Charge Time: About 6 Hours
- + Rechargeable Battery: 12V LI-ION. 6000mAh
- + Power Supply: 120V Wall Power Adapter / DC 12V
- + Dimensions (L x W x H): 9.9"x6.9"x 5.2" -inches



Questions? Issues?

We are here to help!

- Phone: (1) 718-535-1800
- Email: support@pyleusa.com

Warning

This content is compiled from multiple sources and is provided for reference purposes only. It may not be complete or fully applicable to all situations. If you are unable to resolve your issue, please contact the product manufacturer or an authorized service provider for official support.

Document generated by [ManualsFile](#)