

Installation

This dryer must be installed by a qualified technician. The installer is responsible for connecting the dryer to the main power while observing the relevant safety regulations of your area.

What's included

Make sure all the parts are included in the product package. If you have a problem with the dryer or the parts, contact a local Samsung customer center or the retailer.

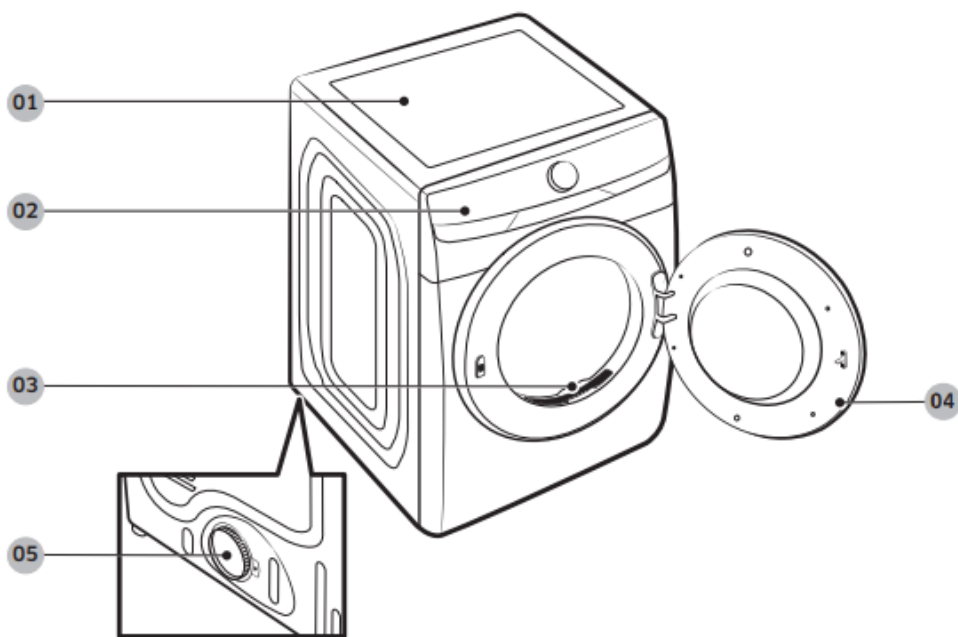

01 Worktop

02 Control panel

03 Lint filter

04 Door

05 Exhaust duct

Before you start

Here are a few things you should know before starting your dryer.

Initial setup

- When you turn on your dryer for the first time, the screen shows the initial setup process. Follow the on-screen instructions to complete it.
- If you complete the initial setup and operate a cycle for more than a minute, the initial setup will not appear again.
- The initial setup includes language selection and a brief tutorial.

- When tapping a button, tap exactly over the text.
- Operating the washing machine and dryer at the same time may result in a loss of power depending on where they are installed and your electrical power status.

01 Language selection	02 Welcome screen
	
03 Tutorial	
	

Sort and load

- Put one wash load in the dryer at a time.
- Do not mix heavy and lightweight items together.
- To improve drying efficiency for one or two items, add a dry towel to the load.
- For best results, untangle items before inserting them into the dryer. Tangled items may degrade the drying efficiency or cause the door to open.
- Overloading reduces the tumbling action, resulting in uneven drying and wrinkling.
- Unless recommended on the care label, do not dry woolens or fiberglass items.
- Avoid drying unwashed items.
- Do not dry items soiled with oil, alcohol, gasoline, etc.

Functional prerequisite

Lint filter

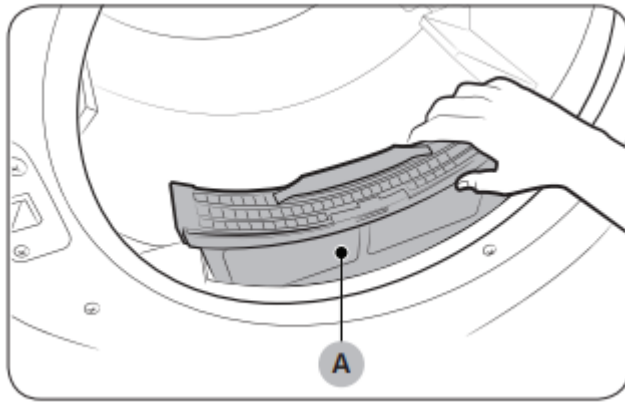

To prevent a risk of fire, make sure to clean the lint filter before or after every load.

1. Turn off the dryer.
2. Open the door and pull out the lint filter (A) from inside the drum.
3. Open the lint filter by separating it at the top. Remove the lint, and then clean the lint filter.
4. Close the lint filter, reinsert the lint filter into the dryer, and then close the dryer door.

CAUTION





- Do not operate the dryer without the lint filter in place.
- Do not use a damaged or broken lint filter. This may reduce performance and/or cause fire.

Operations

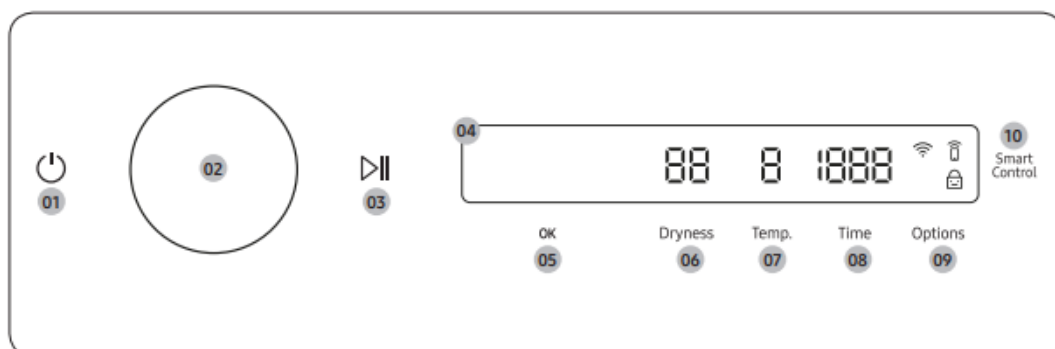
WARNING To reduce the risk of fire, electric shock, or injury, read the “Safety information” before operating this appliance.

Control panel



01. Power 	<p>Tap to turn the dryer on or off.</p> <ul style="list-style-type: none"> • If you do not manipulate the control panel for 10 minutes after the dryer is turned on, the dryer automatically turns off. • The dryer automatically turns off when the drying completes. <p>CAUTION Do not tap  to turn the dryer off while the drying is in progress. Tap and hold to pause the cycle first, and then tap  to turn the dryer off.</p>
02. Navigation dial	Turn the Navigation dial left or right to navigate through cycles and functions. When you turn the Navigation dial, the display shows your selection (such as cycle, additional features, and system functions).
03. Start/Pause 	Tap and hold to start or pause an operation.
04. Display	The display shows the current cycle, estimated time remaining, cycle options, and other useful or alert messages.
05. OK	Tap to confirm your selection of function or setting.
06. Dryness	<p>Tap to change the dry level for the selected cycle. You can select from level 1 to 5, but available level depends on the selected cycle.</p> <ul style="list-style-type: none"> • 4 or 5: Suitable for large and thick items. • 3: Standard drying level. • 2: The Damp dry level is designed to partially dry items. Use for items that lay flat or hang to dry. • 1: Gently dries items to protect fabric. Suitable for delicate items or items you want to naturally dry (by hanging or laying flat on drying rack) while they are damp.
07. Temp.	Temperature can only be adjusted in Time Dry cycle. Tap to change the temperature of the current cycle.
08. Time	Tap to select the cycle time for Small Load, Time Dry, Rack Dry, Air Fluff or Wrinkle Away. You can set the drying time

	between 10 minutes and 90 minutes. Available drying time depend on the selected cycle.
09. Options	<ul style="list-style-type: none"> • Tap to enter the Options menu. • Tap and hold for 3 seconds to enter the System Functions menu.
10. Smart Control (Electric models only) / Smart Monitor (Gas models only)	After connecting the Tumble Dryer to your home network using the SmartThings app, you can control or monitor the dryer remotely. When started, the Smart Control (Smart Monitor) indicator turns on. The dryer enters waiting mode and waits for remote commands.

Icon description

Wi-Fi	This icon indicates that the dryer is connected to Wi-Fi.
Smart Control	This icon indicates that Smart Control is on. For more information on “Smart Control”, see page 49.
Child Lock	This icon indicates that Child Lock is on. For more information on “Child Lock”, see page 46.

Operating a cycle

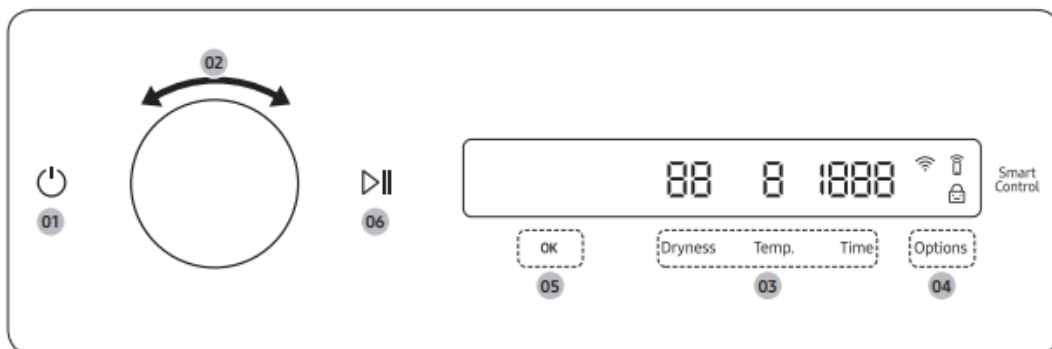

1. Tap to turn on the dryer.
2. Turn the Navigation dial to select the cycle you want. For more information on “Cycle overview”, see page 42.
3. Tap Dryness, Temp., or Time to change the default cycle settings.
4. Tap Options, and then turn the Navigation dial to select additional function. For more information on “Options”, see page 44.

5. Tap OK to change the settings for selected additional function. Not all cycles have additional features available.
6. Tap and hold ▶|| to start operation. Once you set the cycle you want, the screen displays a brief cycle description, and cycle time. You can also check the cycle progress, remaining cycle time, and information codes.

Options

Using Options



1. Tap Options.
2. Turn the Navigation dial to select the desired additional function.
3. Tap OK to change the selected function's settings or start the function.

NOTE

- To return to the main screen, tap Options again or turn the Navigation dial to select Back and tap OK.
- If the selected function is not supported, the "Currently not supported" message is displayed, and the OK button is not activated.
- When you select an additional function, a brief help message appears for the first ten times of use.
- If you do not manipulate the control panel for 7 seconds after entering the Options menu, the display returns to the main screen.

Wrinkle Prevent

Reduces wrinkles by rotating the drum intermittently after completing the dry cycle. Wrinkle Prevent provides approximately 180 minutes. The load is dry and can be removed at any time during the Wrinkle Prevent cycle.



1. Tap Options.
2. Turn the Navigation dial to select Wrinkle Prevent, and then tap OK.
3. Tap OK to select On or Off.

Damp Alert

This function alerts you when shirts and other items that require ironing are dry enough to be suitable for ironing.

1. Select a cycle and change the cycle settings as necessary. This function is available for Normal, Heavy Duty, Bedding, Delicates, Perm Press, Towels and Denim with Dryness set to 2-5.
2. Tap Options.
3. Turn the Navigation dial to select Damp Alert, and then tap OK.
4. Tap OK to select On or Off.

Alarm during drying:

1. Tap and hold  to pause the cycle.
2. Open the door and take out the items you want to iron.
3. Close the door, and then tap and hold  to dry the remaining items.

AntiStatic

Reduces static electricity that occurs from clothing friction. This is done by spraying steam in a later stage of the drying cycle. The AntiStatic function is only available with Normal, Heavy Duty, Perm Press, Delicates, and Time Dry.

1. Tap Options.
2. Turn the Navigation dial to select AntiStatic, and then tap OK.
3. Tap OK to select On or Off.

Eco Dry

With the Eco Dry activated, drying takes a longer time but power consumption is reduced.

This function is available with Normal and Time Dry.

1. Tap Options.
2. Turn the Navigation dial to select Eco Dry, and then tap OK.
3. Tap OK to select On or Off.

NOTE The drying time can be extended by up to 3 times normal depending on the temperature and load. The Eco Dry function is enabled by default.

My Cycles

Add or remove cycles to create a personal cycle list.

1. Tap Options.
2. Turn the Navigation dial to select My Cycles, and then tap OK. You can only edit a cycle to create a personal cycle when the dryer is not operating.
3. Turn the Navigation dial to select a desired cycle.

4. Tap OK to add or remove the selected cycle. Addition and removal of a cycle is saved automatically.
5. Tap Options or select Back to finish My Cycles setting.

NOTE The Normal cycle cannot be removed from the cycles list.

Drum Light

You can turn the drum light on or off.

1. Tap Options.
2. Turn the Navigation dial to select Drum Light, and then tap OK.
3. Tap OK to select On or Off.
 - The drum light turns on even when the dryer is off. (If the dryer is plugged into a power outlet.)
 - When the dryer door opens, the drum light automatically turns on and automatically turns off after minutes.

Child Lock

To prevent children or infants from accidentally starting or setting the dryer, Child Lock locks all buttons except for  and Options.

1. Close the door.
2. Tap Options.
3. Turn the Navigation dial to select Child Lock, and then tap OK.
4. Tap OK to select On or Off.
 - The Child Lock  icon turns on when the function is on.
 - You cannot turn on Child Lock with the door open. If you get the "Door is open" message on the display while you try to turn on Child Lock, close the door and try again.

NOTE

- When Child Lock is on, all buttons are disabled except for  and Options.
- If you tap a button with Child Lock on, an alarm triggers with the "Child Lock on" message.
- If you open and close the door with Child Lock on, an alarm triggers with the "Open door & check inside" and "Child Lock on" message.
- To dismiss a notification message, turn off Child Lock or the power.

System functions

Using System Functions



* Tap and hold 3 seconds.

1. Tap and hold Options for 3 seconds.
2. Turn the Navigation dial and select the desired system function, and then tap OK.
3. Tap OK to change the selected function's settings or start the function.

NOTE

- To return to the main screen, tap Options again or turn the Navigation dial to select Back and tap OK.
- If you do not manipulate the control panel for 7 seconds after entering the System Functions menu, the display returns to the main screen.

AI Pattern

This function saves your frequently used cycles and settings.

1. Tap and hold Options for 3 seconds.
2. Turn the Navigation dial to select AI Pattern, and then tap OK.
3. Tap OK to select On or Off.
 - The default setting is On. Set it to Off if you do not want to use this function.
 - When you turn the function on, the dryer remembers frequently used cycles and their settings (Dry Level Dryness, Time Time) and save them in frequently used order.
 - When you turn off the function, all the saved data resets.

Alarm

You can enable/disable alarm sounds.

1. Tap and hold Options for 3 seconds.
2. Turn the Navigation dial to select Alarm, and then tap OK.
3. Tap OK to select On or Off.
 - The default setting is On.

NOTE The setting remains unchanged even if you restart the dryer.

Wi-Fi

You can turn the dryer's Wi-Fi on or off.

1. Tap and hold Options for 3 seconds.
2. Turn the Navigation dial to select Wi-Fi, and then tap OK.
3. Tap OK to select On or Off.

- The dryer's Wi-Fi is off as a factory default setting. However, the dryer's Wi-Fi turns on automatically when you turn on the dryer for the first time. Then, the final Wi-Fi setting maintains regardless of the dryer power status.
- Once you turn on the dryer's Wi-Fi and connect to a network, the dryer remains connected to the network even when you turn off the power.
- The Wi-Fi  indicates that the dryer is connected to the router through the Wi-Fi connection.

Language

You can change the system language.

1. Tap and hold Options for 3 seconds.
2. Turn the Navigation dial to select Language, and then tap OK.
3. Turn the Navigation dial to select the desired language, and then tap OK.

Vent Blockage Test

Detects the status of the ducts and reports any blockage or problems.

1. Tap and hold Options for 3 seconds.
2. Turn the Navigation dial to select Vent Blockage Test, and then tap OK.
 - Vent Blockage Test starts immediately.

Factory Reset

You can reset your dryer.

1. Tap and hold Options for 3 seconds.
2. Turn the Navigation dial to select Factory Reset, and then tap OK.
 - Your dryer resets to the factory setting.

Maintenance

Keep the dryer clean for best performance and to lengthen its life cycle.

WARNING

Certain internal parts are intentionally not grounded and may present a risk of electric shock only during servicing.

Service Personnel - Do not contact the following parts while the appliance is energized: Control board and inlet valve.

Cleaning

Control panel

- Clean with a soft, damp cloth. Do not use abrasive substances.
- Do not spray liquid cleaning agents directly onto the dryer display.
- Some laundry pre-treatment soil and stain removers may damage the control panel.
- When using liquid cleaning agents, apply them to the cleaning cloth. Do not apply them directly to the dryer. Wipe up any spills or overspray immediately.

Drum

- Remove any stains from the drum with an allpurpose cleaner.
- Tumble old towels or rags to remove any remaining stains or cleaning substances. Stains may still be visible, but will not affect subsequent loads.

Powder coated drum

To clean the powder coated drum, use a damp cloth with a mild, non-abrasive cleaner suitable for easily marred surfaces.

Remove cleaner residue and dry with a clean cloth.

Dryer exterior

- Clean with a soft, damp cloth. Do not use abrasive substances.
- Protect the surface from sharp objects.
- Do not place any heavy or sharp objects or a detergent container on the dryer. They can scratch or damage the top cover of the dryer.
- The dryer has a high-gloss finish on the entire surface. Be careful not to scratch or damage the surface.

Exhaust system

- Check and clean the exhaust system on a regular basis to maintain optimum performance.
- The external exhaust hood must be cleaned frequently to ensure proper airflow.

Troubleshooting

Checkpoints

If you encounter a problem with the dryer, first check the table below and try the suggestions.



Problem	Action
Dryer does not start.	<ul style="list-style-type: none"> • Make sure the dryer is plugged in. • Make sure the door is properly closed. • Check the fuse or reset the circuit breaker. • If you opened the door during a cycle, tap and hold  again. • Clean the filter. • Make sure Child Lock is not activated.
The dryer does not warm up.	<ul style="list-style-type: none"> • Check your home's circuit breakers or fuses. • Some cycles do not require heat. Check the selected cycle again. • For a gas dryer, make sure the gas supply is on. • Clean the lint filter and exhaust duct. • The dryer may have moved into the cool-down phase of the cycle. • Turn off the Eco Dry option for the Normal or Time Dry cycles. When the Eco Dry option is on, the dryer performs an air dry process in the beginning of the cycle to reduce energy consumption. The air dry process does not use heated air, so you may feel that the dryer is not being heated, but this is normal.
Items are not dried.	<p>Check all of the above. Additionally:</p> <ul style="list-style-type: none"> • Make sure the exhaust hood outside your home can open and close freely. • Check the exhaust system for lint buildup. Ducting should be inspected and cleaned annually. • Use a 4" rigid metal exhaust duct. • Do not overload. 1 wash load = 1 dryer load. • Dry heavy items and light weight items separately. • Large, bulky items, such as blankets or comforters, may require repositioning to ensure even drying.

	<ul style="list-style-type: none"> • Make sure that your washer is draining properly and extracting adequate water from the load. • The load may be too small to tumble properly. Add a few towels and restart the dryer. • The load may be too large to tumble properly. Remove some items and restart the dryer. • Clean the lint filter.
The dryer is too loud.	<ul style="list-style-type: none"> • Look for coins, loose buttons, nails, and other objects and remove them immediately. • Check the lint filter. Remove any items stuck inside the lint filter. • Make sure the dryer is level and standing firmly on the floor. • The dryer may hum due to air moving through the drum and fan. This is normal. • It is normal to hear the dryer gas valve or heating element cycle on and off during the drying cycle.
Items are not dried evenly.	<ul style="list-style-type: none"> • Seams, pockets, and other parts of clothing are harder to dry than others. This is normal. • Sort heavy and light items separately.
There is a smell coming from the dryer.	<ul style="list-style-type: none"> • The smell of paint, varnish, cleaning agents, and other household items could have circulated in the air and entered the dryer. If you notice such a smell, ventilate completely before using the dryer. • If drying in an enclosed area, the dryer could cause the ambient temperature to rise. Accordingly, make sure to open a window and ventilate the area. • Do not attempt to dry wet items after leaving them in the washing machine or dryer for a long time.
The dryer turns off before the items are dry	<ul style="list-style-type: none"> • The load is too small. Throw in few additional items like towels and try drying again.

<p>The clothes have lint on them.</p>	<ul style="list-style-type: none"> • Always make sure the lint filter is clean before putting items into the dryer. When drying items that generate a large amount of lint, you may need to clean the lint filter in the middle of a cycle. • Some fabrics (such as white towels) causes more lint and should be dried separately from fabrics that lint attaches easily (such as black linen pants). • Check the inside of the pockets to make sure they are empty before drying.
<p>Items still wrinkled after Wrinkle Prevent (Wrinkle Away, Wrinkle Release).</p>	<ul style="list-style-type: none"> • Small loads of 1 to 4 items work best. • Load fewer items. Load similar-type items. • Take out the items immediately after drying is complete.
<p>Water drips from the nozzle when the Steam cycles starts.</p>	<ul style="list-style-type: none"> • This is steam condensation. The dripping water will stop after a short time.
<p>Sprayed water is not visible during Steam cycles.</p>	<ul style="list-style-type: none"> • Sprayed water is difficult to see when the door is closed.
<p>Extended time.</p>	<ul style="list-style-type: none"> • Sensor Dry automatically senses the moisture in the load and shuts the dryer off when the selected dryness level is reached. <p>The drying time can change according to the type and amount of laundry. See the cycle chart for reference.</p>

If a problem persists, contact a local Samsung service center.

Information codes

If the dryer fails to operate, you may see an information code on the display panel. To determine what you should do, check the list of codes in the table below, and then try the suggested actions.



Information code	Meaning	Action
Door is open	Operating the dryer with the door open.	<ul style="list-style-type: none"> • Make sure the door is properly closed. • Make sure laundry is not caught in the door
FC	Invalid power source frequency.	<ul style="list-style-type: none"> • Try restarting the cycle. • If this information code remains, contact a Samsung service center.
AC	Electronic control problem (Invalid Communication).	Contact a Samsung service center.
HC	High temperature heating check.	<ul style="list-style-type: none"> • Clean the lint filter. • If this information code remains, contact a Samsung service center.
9C1	The electronic control needs to be checked.	<ul style="list-style-type: none"> • Check if power cord is connected properly. • Check if the electrical outlet is working properly. • If the information code remains, contact a Samsung service center.
tC	The Thermistor1 resistance is very low or high.	<ul style="list-style-type: none"> • Check for a clogged lint screen. • Check if the vent system is restricted. • If this information code remains, contact a Samsung service center.
tC5		<ul style="list-style-type: none"> • Check for a clogged lint screen.

	The Thermistor2 resistance is very low or high.	<ul style="list-style-type: none"> • Check if the vent system is restricted. • If this information code remains, contact a Samsung service center.
dF	Incorrect door switch.	Contact a Samsung service center
3C	The PBA needs to be checked.	<ul style="list-style-type: none"> • Unplug the power plug and contact a Samsung service center.

If any information code keeps appearing on the display, contact a Samsung service center.

Warning

This content is compiled from multiple sources and is provided for reference purposes only. It may not be complete or fully applicable to all situations. If you are unable to resolve your issue, please contact the product manufacturer or an authorized service provider for official support.

