

BASICS

Device layout

Galaxy A22:

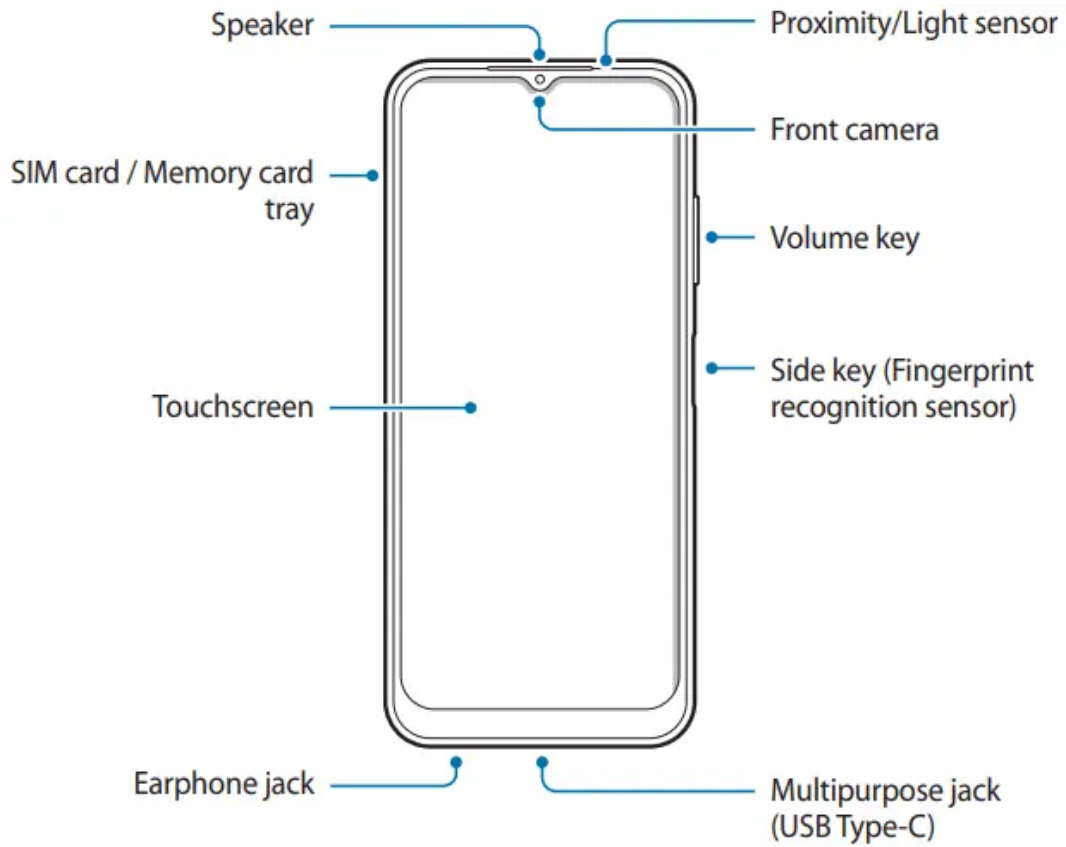

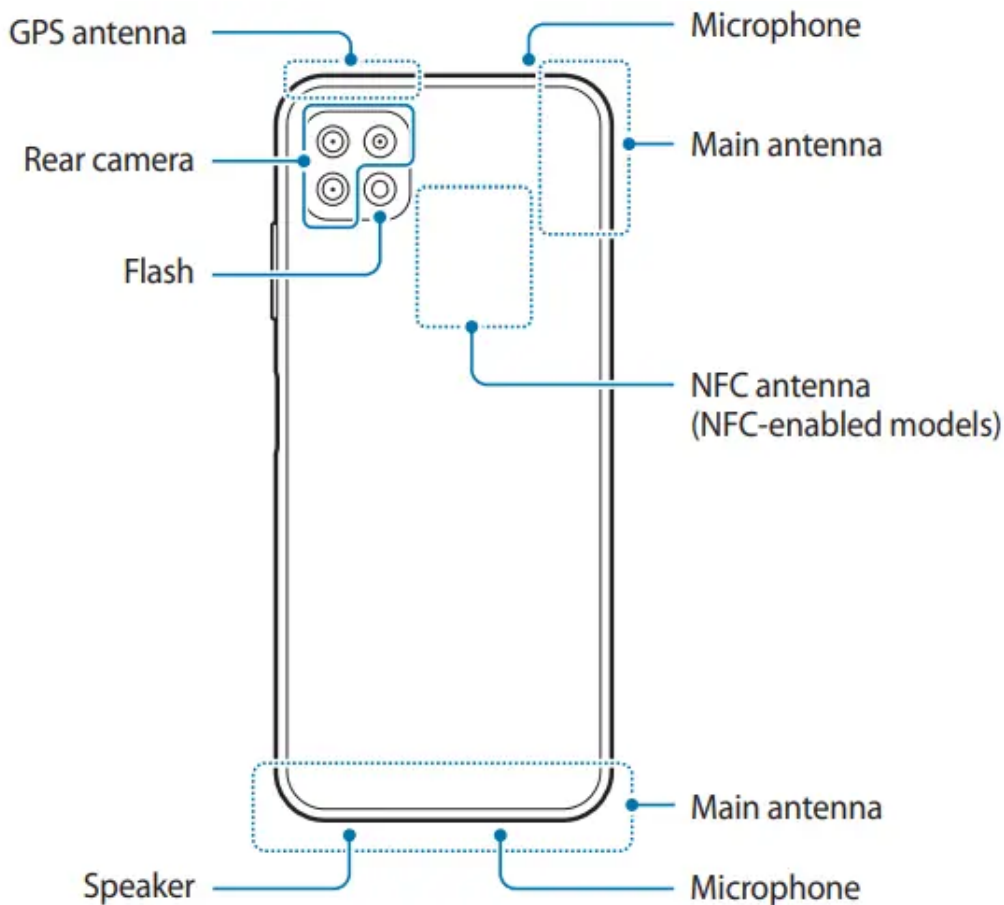

WARNING

- When using the speakers, such as when playing media files or using speakerphone, do not place the device close to your ears.
- Be careful not to expose the camera lens to a strong light source, such as direct sunlight. If the camera lens is exposed to a strong light source, such as direct sunlight, the camera image sensor may be damaged. A damaged image sensor is irreparable and will cause dots or spots in pictures.
- If you use the device with its glass or acrylic body broken, there may be a risk of injury. Use the device only after it has been repaired at a Samsung Service Centre.
- If dust or foreign materials enter the microphone, speaker, or receiver, the device's sound may become quiet or certain features may not work. If you attempt to remove the dust or foreign materials with a sharp object, the device may be damaged and its appearance may be affected.

NOTE

- Connectivity problems and battery drain may occur in the following situations:
 - If you attach metallic stickers on the antenna area of the device
 - If you attach a device cover made with metallic material to the device

- If you cover the device's antenna area with your hands or other objects while using certain features, such as calls or the mobile data connection
- Using a Samsung-approved screen protector is recommended. Unapproved screen protectors may cause the sensors to malfunction.
- Do not cover the proximity/light sensor area with screen accessories, such as a screen protector, stickers, or a cover. Doing so may cause the sensor to malfunction. (Galaxy A22 5G)
- Do not allow water to contact the touchscreen. The touchscreen may malfunction in humid conditions or when exposed to water.

Hard keys

Key	Function
Side key	<ul style="list-style-type: none"> • Press and hold to turn the device on or off. • Press to turn on or lock the screen. • Press twice to launch the app or feature you set.
Side key + Volume Down key	<ul style="list-style-type: none"> • Press simultaneously to capture a screenshot. • Press and hold simultaneously to turn off the device.

Setting the Side key

Select an app or feature to launch by pressing the Side key twice. Launch the Settings app, tap Advanced features → Side key, and then select an option you want.

Soft buttons

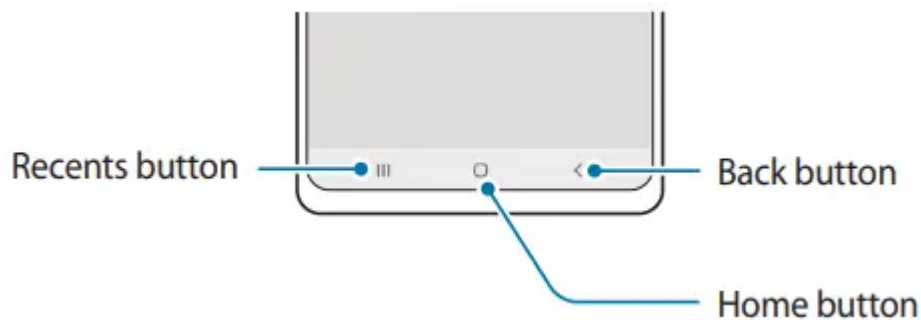

When you turn on the screen, the soft buttons will appear at the bottom of the screen. Refer to Navigation bar (soft buttons) for more information.

Charging the battery

Charging the battery

Charge the battery before using it for the first time or when it has been unused for extended periods.

Use only Samsung-approved battery, charger, and cable specifically designed for your device. Incompatible battery, charger, and cable can cause serious injuries or damage to your device.

- Connecting the charger improperly may cause serious damage to the device. Any damage caused by misuse is not covered by the warranty.
- Use only USB Type-C cable supplied with the device. The device may be damaged if you use Micro USB cable.

To save energy, unplug the charger when not in use. The charger does not have a power switch, so you must unplug the charger from the electric socket when not in use to avoid wasting power. The charger should remain close to the electric socket and easily accessible while charging.

Wired charging

Connect the USB cable to the USB power adaptor and plug the cable into the device's multipurpose jack to charge the battery. After fully charging, disconnect the charger from the device.

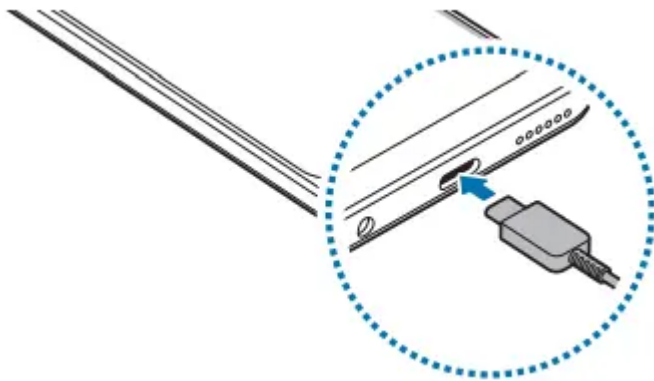

Quick charging

Launch the Settings app, tap Battery and device care → Battery → More battery settings, and then activate the feature you want.

- Fast charging: To use the fast charging feature, use a battery charger that supports Adaptive fast charging.

NOTE You can charge the battery more quickly while the device or its screen is turned off

Reducing the battery consumption

Your device provides various options that help you conserve battery power.

- Optimise the device using the device care feature.
- When you are not using the device, turn off the screen by pressing the Side key.
- Activate power saving mode.
- Close unnecessary apps.
- Deactivate the Bluetooth feature when not in use.
- Deactivate auto-syncing of apps that need to be synced.
- Decrease the backlight time.
- Decrease the screen brightness.

Battery charging tips and precautions

- If the battery is completely discharged, the device cannot be turned on immediately when the charger is connected. Allow a depleted battery to charge for a few minutes before turning on the device.
- If you use multiple apps at once, network apps, or apps that need a connection to another device, the battery will drain quickly. To avoid losing power during a data transfer, always use these apps after fully charging the battery.
- Using a power source other than the charger, such as a computer, may result in a slower charging speed due to a lower electric current.
- The device can be used while it is charging, but it may take longer to fully charge the battery.
- If the device receives an unstable power supply while charging, the touchscreen may not function. If this happens, unplug the charger from the device.
- While charging, the device and the charger may heat up. This is normal and should not affect the device's lifespan or performance. If the battery gets hotter than usual, the charger may stop charging.
- If you charge the device while the multipurpose jack is wet, the device may be damaged.
- Thoroughly dry the multipurpose jack before charging the device.
- If the device is not charging properly, take the device and the charger to a Samsung Service Centre.

SIM or USIM card (nano-SIM card)

Insert the SIM or USIM card provided by the mobile telephone service provider.

For dual SIM models, you can insert two SIM or USIM cards so you can have two phone numbers or service providers for a single device. In some areas, data transfer speeds may be slower if two SIM cards are inserted in the device than when one SIM card is inserted.

Some services that require a network connection may not be available depending on the service provider.

Installing the SIM or USIM card

► Galaxy A22:

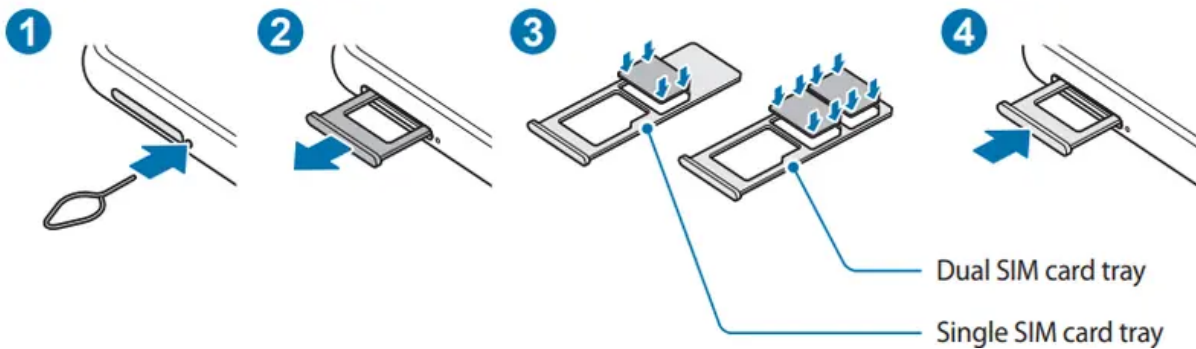

► Galaxy A22 5G:

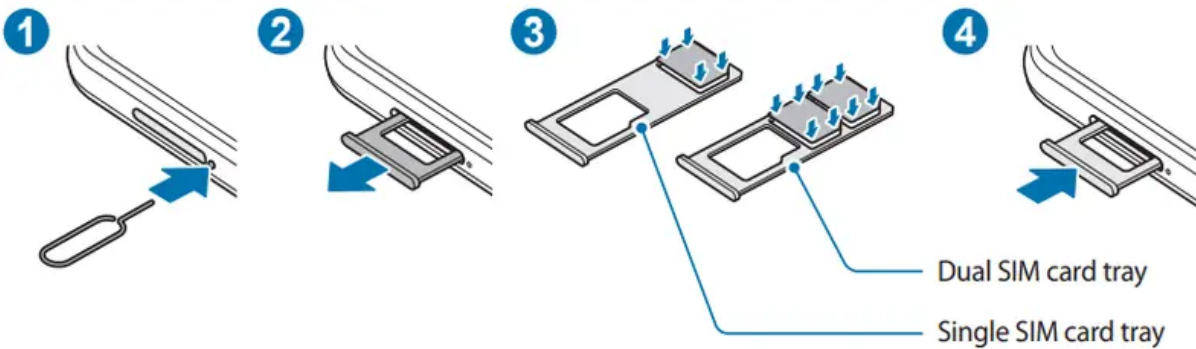

1. Insert the ejection pin into the hole next to the tray to loosen the tray.
2. Pull out the tray gently from the tray slot.
3. Place the SIM or USIM card on the tray with the gold-coloured contacts facing downwards and gently press the SIM or USIM card into the tray to secure it.
4. Insert the tray back into the tray slot.

WARNING

- Use only a nano-SIM card.
- Use caution not to lose or let others use the SIM or USIM card. Samsung is not responsible for any damages or inconveniences caused by lost or stolen cards.
- Ensure that the ejection pin is perpendicular to the hole. Otherwise, the device may be damaged.
- If the card is not fixed firmly into the tray, the SIM card may leave or fall out of the tray.
- If you insert the tray into your device while the tray is wet, your device may be damaged. Always make sure the tray is dry.

- Fully insert the tray into the tray slot to prevent liquid from entering your device.

SIM card manager (dual SIM models)

Launch the Settings app and tap Connections → SIM card manager.

- SIM cards: Activate the SIM card to use and customise the SIM card settings.
- Preferred SIM card: Select to use specific SIM cards for some features, such as voice calls, when two cards are activated.
- More SIM card settings: Customise the call settings.

Memory card (microSD card)

Installing a memory card

Your device's memory card capacity may vary from other models and some memory cards may not be compatible with your device depending on the memory card manufacturer and type. To view your device's maximum memory card capacity, refer to the Samsung website.

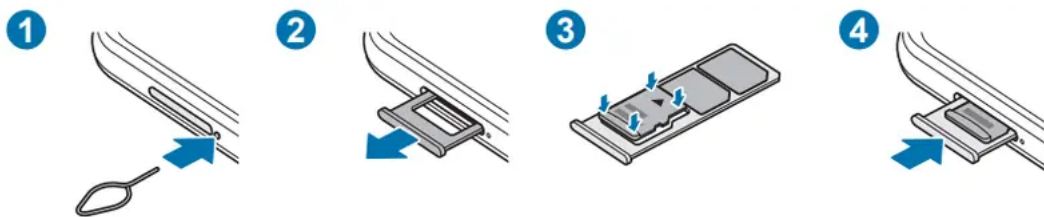

1. Insert the ejection pin into the hole next to the tray to loosen the tray.
2. Pull out the tray gently from the tray slot.
3. Place a memory card on the tray with the gold-coloured contacts facing downwards and gently press the memory card into the tray to secure it.
4. Insert the tray back into the tray slot.

WARNING

- Some memory cards may not be fully compatible with the device. Using an incompatible card may damage the device or the memory card, or corrupt the data stored in it.
- Use caution to insert the memory card right-side up.
- Ensure that the ejection pin is perpendicular to the hole. Otherwise, the device may be damaged.
- When you remove the tray from the device, the mobile data connection will be disabled.
- If the card is not fixed firmly into the tray, the memory card may leave or fall out of the tray.

- If you insert the tray into your device while the tray is wet, your device may be damaged. Always make sure the tray is dry.
- Fully insert the tray into the tray slot to prevent liquid from entering your device.
- The device supports the FAT32 and the exFAT file systems for memory cards. When inserting a card formatted in a different file system, the device will ask to reformat the card or will not recognise the card. To use the memory card, you must format it. If your device cannot format or recognise the memory card, contact the memory card manufacturer or a Samsung Service Centre.
- Frequent writing and erasing of data shortens the lifespan of memory cards.
- When inserting a memory card into the device, the memory card's file directory appears in the My Files → SD card folder.

Removing the memory card

Before removing the memory card, first unmount it for safe removal.

Launch the Settings app and tap Battery and device care → Storage →  → Advanced → SD card → Unmount.

WARNING Do not remove external storage, such as a memory card or USB storage, while the device is transferring or accessing information, or right after transferring data. Doing so can cause data to be corrupted or lost or cause damage to the external storage or device. Samsung is not responsible for losses, including loss of data, resulting from the misuse of external storage devices.

Formatting the memory card

A memory card formatted on a computer may not be compatible with the device. Format the memory card on the device.

Launch the Settings app and tap Battery and device care → Storage →  → Advanced → SD card → Format.

WARNING Before formatting the memory card, remember to make backup copies of all important data stored in the memory card. The manufacturer's warranty does not cover loss of data resulting from user actions.

Turning the device on and off

Follow all posted warnings and directions from authorised personnel in areas where the use of wireless devices is restricted, such as aeroplanes and hospitals.

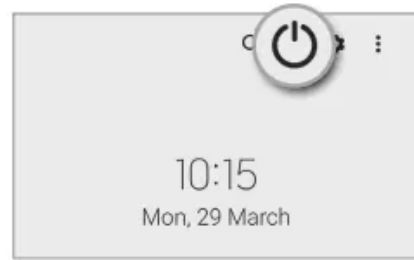
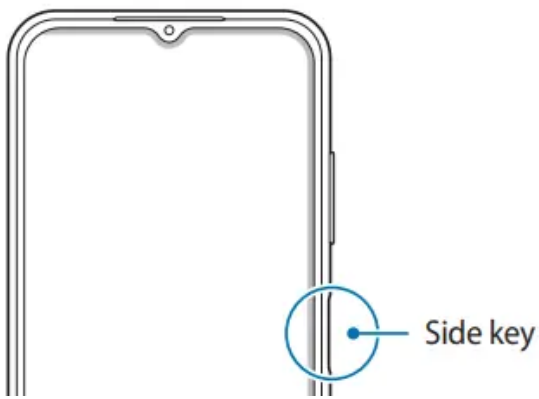

Turning the device on

Press and hold the Side key for a few seconds to turn on the device.

Turning the device off

1. To turn off the device, press and hold the Side key. Alternatively, open the notification panel, swipe downwards, and then tap .

2. Tap Power off.

To restart the device, tap Restart.

Forcing restart

If your device is frozen and unresponsive, press and hold the Side key and the Volume Down key simultaneously for more than 7 seconds to restart it.

Emergency mode

You can switch the device to emergency mode to reduce battery consumption. Some apps and functions will be restricted. In emergency mode, you can make an emergency call, send your current location information to others, sound an emergency alarm, and more.

To activate emergency mode, press and hold the Side key, and then tap Emergency mode.

Alternatively, open the notification panel, swipe downwards, and then tap  → Emergency mode.

To deactivate emergency mode, tap  → Turn off Emergency mode.

NOTE The usage time left shows the time remaining before the battery power runs out. Usage time left may vary depending on your device settings and operating conditions.

Initial setup

When you turn on your device for the first time or after performing a data reset, follow the on-screen instructions to set up your device.

NOTE If you do not connect to a Wi-Fi network, you may not be able to set up some device features during the initial setup.

Samsung account

Your Samsung account is an integrated account service that allows you to use a variety of Samsung services provided by mobile devices, TVs, and the Samsung website. To check the list of services that can be used with your Samsung account, visit account.samsung.com.

1. Launch the Settings app and tap Samsung account.
Alternatively, launch the Settings app and tap **Accounts and backup** → **Manage accounts** → **Add account** → **Samsung account**.
2. If you already have a Samsung account, sign in to your Samsung account.
 - If you want to sign in using your Google account, tap Continue with Google.
 - If you do not have a Samsung account, tap Create account.

Finding your ID and resetting your password

If you forget your Samsung account ID or password, tap Find ID or Reset password on the Samsung account sign-in screen. You can find your ID or reset your password after you enter the required information.

Signing out of your Samsung account

When you sign out of your Samsung account, your data, such as contacts or events, will also be removed from your device.

1. Launch the Settings app and tap Accounts and backup → Manage accounts.
 2. Tap Samsung account → My profile and tap Sign out at the bottom of the screen.
 3. Tap Sign out, enter your Samsung account password, and then tap OK.
-

Transferring data from your previous device (Smart Switch)

You can use Smart Switch to transfer data from your previous device to your new device.

Launch the Settings app and tap Accounts and backup → Bring data from old device.

NOTE

- This feature may not be supported on some devices or computers.
- Limitations apply. Visit www.samsung.com/smartswitch for details. Samsung takes copyright seriously. Only transfer content that you own or have the right to transfer.

Transferring data wirelessly

Transfer data from your previous device to your device wirelessly via Wi-Fi Direct.

1. On the previous device, launch Smart Switch. If you do not have the app, download it from Galaxy Store or Play Store.
2. On your device, launch the Settings app and tap Accounts and backup → Bring data from old device.
3. Place the devices near each other.
4. On the previous device, tap Send data → Wireless.
5. On the previous device, tap Allow.
6. On your device, select an item to bring and tap Transfer.

Backing up and restoring data using external storage

Transfer data using external storage, such as a microSD card.

1. Back up data from your previous device to external storage.
2. Insert or connect the external storage device to your device.
3. On your device, launch the Settings app and tap Accounts and backup → External storage transfer.
4. Select the backup date under Restore from SD card and tap Restore.
5. Follow the on-screen instructions to transfer data from external storage.

Transferring backup data from a computer



1. On the computer, visit www.samsung.com/smartswitch to download Smart Switch.
2. On the computer, launch Smart Switch.

NOTE If your previous device is not a Samsung device, back up data to a computer using a program provided by the device's manufacturer. Then, skip to the fifth step.

3. Connect your previous device to the computer using the device's USB cable.
4. On the computer, follow the on-screen instructions to back up data from the device. Then, disconnect your previous device from the computer.
5. Connect your device to the computer using the USB cable.
6. On the computer, follow the on-screen instructions to transfer data to your device.

UNDERSTANDING THE SCREEN

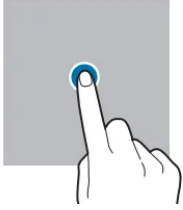
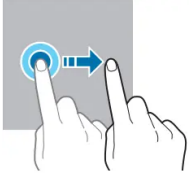
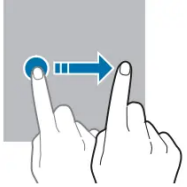
Controlling the touchscreen

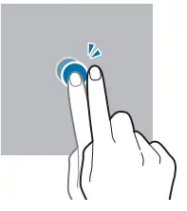
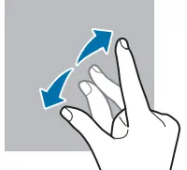
<p>Tapping Tap the screen.</p>	
<p>Dragging Tap and hold an item and drag it to the target position.</p>	
<p>Swiping Swipe upwards, downwards, to the left, or to the right.</p>	
<p>Tapping and holding Tap and hold the screen for approximately 2 seconds.</p>	
<p>Double-tapping Double-tap the screen.</p>	
<p>Spreading and pinching Spread two fingers apart or pinch on the screen.</p>	

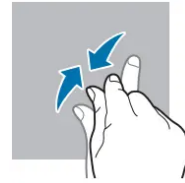

WARNING

- Do not allow the touchscreen to come into contact with other electrical devices.

Electrostatic discharges can cause the touchscreen to malfunction.













- To avoid damaging the touchscreen, do not tap it with anything sharp or apply excessive pressure to it with your fingertips.
- It is recommended not to use fixed graphics on part or all of the touchscreen for extended periods. Doing so may result in afterimages (screen burn-in) or ghosting.

NOTE The device may not recognise touch inputs close to the edges of the screen, which are outside of the touch input area.

Indicator icons

Indicator icons appear on the status bar at the top of the screen. The icons listed in the table below are most common.

Icon	Meaning
	No signal
	Signal strength
	Roaming (outside of normal service area)
	GPRS network connected
	EDGE network connected
	UMTS network connected
	HSDPA network connected
	HSPA+ network connected
	LTE network connected
	5G network connected

Icon	Meaning
	LTE network connected in LTE network that includes the 5G network
	Wi-Fi connected
	Bluetooth feature activated
	Location services being used
	Call in progress
	Missed call
	New text or multimedia message
	Alarm activated
	Mute mode / Vibration mode
	Flight mode activated
	Error occurred or caution required
	Battery charging / Battery power level

- The status bar may not appear at the top of the screen in some apps. To display the status bar, drag down from the top of the screen.
- Some indicator icons appear only when you open the notification panel.
- The indicator icons may appear differently depending on the service provider or model.

APPS AND FEATURES

Camera

Portrait mode

The camera allows you to take pictures where the background is blurred and the subject stands out clearly.

1. On the shooting modes list, tap PORTRAIT.
2. Drag the background blur adjustment bar to adjust the blur level.
3. When Ready appears on the preview screen, tap to take a picture.



Background blur adjustment bar



- Use this feature in a place that has sufficient light.
- The background blur may not be applied properly in the following conditions:
 - The device or the subject is moving.
 - The subject is thin or transparent.
 - The subject has a similar colour to the background.
 - The subject or background is plain

Pro mode

Capture pictures while manually adjusting various shooting options, such as exposure value and ISO value. On the shooting modes list, tap MORE → PRO. Select options and customise the

settings, and then tap  to take a picture

Available options

-  Select an ISO value. This controls camera light sensitivity. Low values are for stationary or brightly lit objects. Higher values are for fast-moving or poorly lit objects. However, higher ISO settings can result in noise in pictures.
-  : Select an appropriate white balance, so images have a true-to-life colour range. You can set the colour temperature.
-  : Change the exposure value. This determines how much light the camera's sensor receives. For low-light situations, use a higher exposure.



Separating the focus area and the exposure area

You can separate the focus area and the exposure area. Tap and hold the preview screen. The AF/AE frame will appear on the screen. Drag the frame to the area where you want to separate the focus area and the exposure area.



Panorama mode



Using panorama mode, take a series of pictures and then stitch them together to create a wide scene.

1. On the shooting modes list, tap MORE → PANORAMA.
2. Tap  and move the device slowly in one direction. Keep the image within the frame on the camera's viewfinder. If the preview image is out of the guide frame or you do not move the device, the device will automatically stop taking pictures.
3. Tap  to stop taking pictures.

NOTE Avoid taking pictures of indistinct backgrounds, such as an empty sky or a plain wall.

Food mode

Take pictures of food with more vibrant colours.

1. On the shooting modes list, tap MORE → FOOD.
2. Tap the screen and drag the circular frame over the area to highlight. The area outside the circular frame will be blurred. To resize the circular frame, drag a corner of the frame.
3. Tap  and drag the adjustment bar to adjust the colour tone.
4. Tap  to take a picture.



Night mode

Take a picture in low-light conditions, without using the flash. When you use a tripod, you can get brighter and steadier results.

1. On the shooting modes list, tap MORE → NIGHT.
2. Tap  and hold your device steady until shooting is complete

Slow motion mode

Record a video for viewing it in slow motion. You can specify sections of your videos to be played in slow motion.

1. On the shooting modes list, tap MORE → SLOW MOTION and tap  to record a video.
2. When you are finished recording, tap  to stop.
3. On the preview screen, tap the preview thumbnail.

The fast section of the video will be set as a slow motion section and the video will start playing. Up to two slow motion sections will be created based on the video.

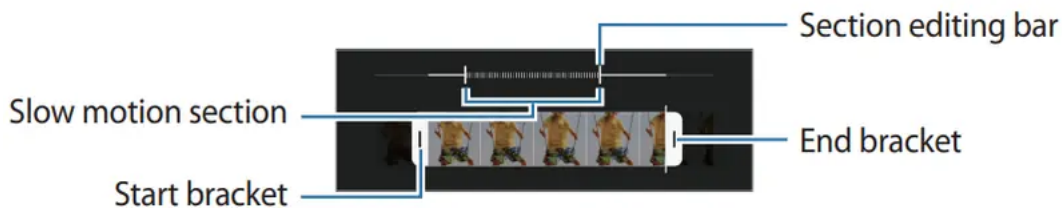

To edit the slow motion section, tap  and drag the section editing bar to the left or right.



Hyperlapse mode

Record scenes, such as passing people or cars, and view them as fast-motion videos.

1. On the shooting modes list, tap MORE → HYPERLAPSE.

2. Tap  or  and select a frame rate option.

If you set the frame rate to Auto, the device will automatically adjust the frame rate according to the changing rate of the scene. (Galaxy A22)

3. Tap  to start recording.

4. Tap  to finish recording.

NOTE You can use the night hyperlapse feature by tapping  on the shooting options. This feature is good for doing things like taking shots from moving cars that make the light look like it is also moving. (Galaxy A22)

Deco Pic mode (Galaxy A22 5G)

Capture pictures or videos with various stickers. On the shooting modes list, tap MORE → Deco Pic.

Settings

Intelligent features

- Scene optimiser: Set the device to adjust the colour settings and apply the optimised effect automatically depending on the subject or scene.

Scan QR codes: Set the device to scan QR codes from the preview screen.

Pictures

- Swipe Shutter button to / Swipe Shutter button to edge to: Select an action to perform when you swipe the camera button to the edge of the screen and hold it.
- HEIF pictures: Take pictures in the High Efficiency Image Format (HEIF).

Selfies

- Use wide angle for group selfies: Set the device to automatically switch to a wide-angle selfie when there are more than two people in the frame.
- Save selfies as previewed: Set the device to save pictures as they appear on the preview screen when taken with the front camera without flipping them.

Videos

- Video stabilisation: Activate anti-shake to reduce or eliminate blurry image resulting from camera shake while recording a video.
- High efficiency videos / High efficiency video: You can record videos in the High

Efficiency Video Codec (HEVC) format. Your HEVC videos will be saved as compressed files to conserve the device's memory.

NOTE

- You cannot play the HEVC videos on other devices or share them online.
- Slow motion videos cannot be recorded in the HEVC format.

Useful features

- Auto HDR: Take pictures with rich colours and reproduce details even in bright and dark areas.
- Grid lines: Display viewfinder guides to help composition when selecting subjects.
- Location tags: Attach a GPS location tag to the picture.

NOTE

- GPS signal strength may decrease in locations where the signal is obstructed, such as between buildings or in low-lying areas, or in poor weather conditions.
- Your location may appear on your pictures when you upload them to the

Internet. To avoid this, deactivate the location tag setting.

- Shooting methods: Select additional shooting methods for taking a picture or recording a video.
- Settings to keep: Keep the last settings you used, such as the shooting mode, when you launch the camera.
- Storage location: Select the memory location for storage. This feature will appear when you insert a memory card.
- Watermark: Add a watermark in the bottom left corner when taking pictures.
- Reset settings: Reset the camera settings.
- Contact us: Ask questions or view frequently asked questions.
- About Camera: View the Camera app version and legal information.
Some features may not be available depending on the model.

AR Zone (Galaxy A22)

Introduction

AR Zone provides you AR related features. Choose a feature and capture fun pictures or videos.

Launching AR Zone

- Use the following methods to launch AR Zone:
Launch the AR Zone app.
- Launch the Camera app and tap MORE → AR ZONE.
NOTE Some features may not be available depending on the service provider or model.



Creating AR Emoji

Make an emoji that looks like you.

1. Launch the AR Zone app and tap AR Emoji Studio → Make from selfie.
- 2.

Align your face on the screen, tap  to take a picture, and then follow the on-screen instructions to create an emoji.

Deleting an emoji

Launch the AR Zone app and tap AR Emoji Studio. Tap  → , tick the emoji you want to delete, and then tap Delete.

AR Emoji Stickers

Create your own stickers with your emoji's expressions and actions. You can use your emoji stickers when sending messages or on a social network.

Creating your own stickers

1. Launch the AR Zone app and tap AR Emoji Stickers.
2. Tap Make custom stickers at the bottom of the screen.
3. Edit stickers how you want and tap Save.

You can view the stickers you have created by tapping Custom.

Deleting emoji stickers

Launch the AR Zone app and tap AR Emoji Stickers →  → Delete stickers. Select the emoji stickers to delete and tap Delete.

Using your emoji stickers in chats

You can use your emoji stickers during a conversation via messages or on a social network. The following actions are an example of using your emoji stickers in the Messages app.

1. While composing a message in the Messages app, tap  on the Samsung keyboard.
 2. Tap the emoji icon.
 3. Select one of your emoji stickers.
- The emoji sticker will be inserted.

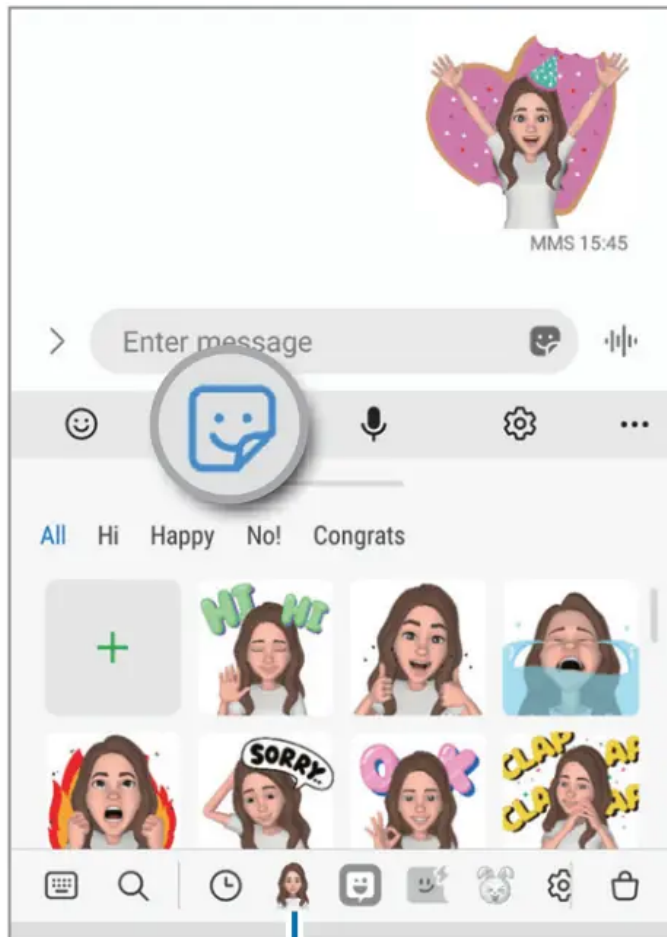

Emoji icon

Multi window

Multi window lets you run two apps at the same time in the split screen view. You can also run multiple apps at the same time in the pop-up view.

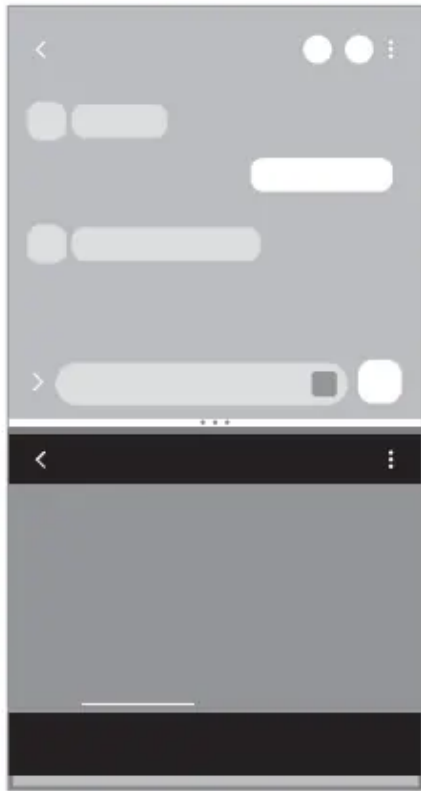

Split screen view

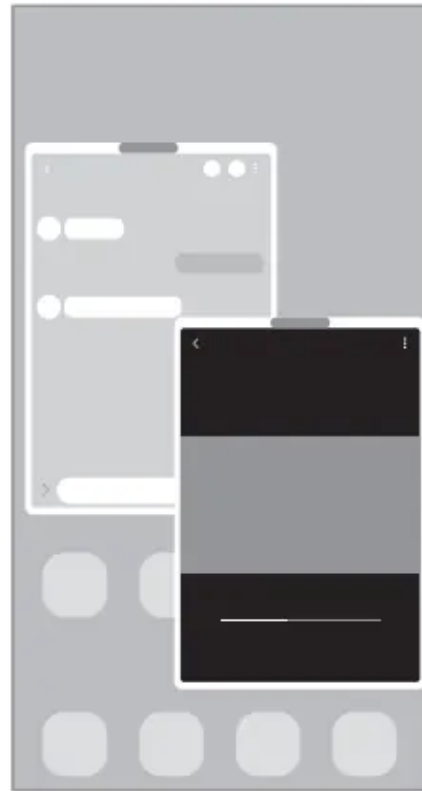

Pop-up view

Split screen view

1. Tap the Recents button to open the list of recently used apps.
2. Swipe to the left or right, tap an app's icon, and then tap Open in split screen view.
3. On the apps list, select another app to launch.

Launching apps from the Edge panel

1. While using an app, drag the Edge panel handle towards the centre of the screen.
2. Tap and hold an app, drag it to the left, and then drop it where Drop here to open appears. The selected app will launch in the split screen view.

Note: You can set to launch an app in the split screen view by tapping it once.

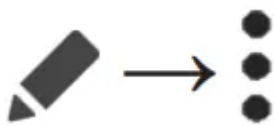

and tap Tap under Open in split screen view. If you tap the Show recent apps switch to activate it, you can launch the recently used apps in the split screen view from the Edge panel.

Adding app pairs

Add two frequently used apps to the Edge panel to launch them together in the split screen view with a single tap.

1. In the split screen view, tap the circles between the app windows.



2. Tap .

The two apps you are using in the split screen view will be saved on the Edge panel as an app pair.

Adjusting the window size

Drag the circles between the app windows up or down to adjust the size of the windows. When you drag the circles between the app windows to the top or bottom edge of the screen, the window will be maximised.

Pop-up view

1. Tap the Recents button to open the list of recently used apps.
2. Swipe to the left or right, tap an app's icon, and then tap Open in pop-up view.

The app screen will appear in the pop-up view.

If you tap the Home button while using a pop-up window, the window will be minimised and displayed as an app icon. To use the pop-up window again, tap the app icon.

Launching apps from the Edge panel

1. Drag the Edge panel handle towards the centre of the screen.
2. Tap and hold an app, drag it to the left, and then drop it where Drop here for pop-up view appears.

The selected app will launch in the pop-up view.

Moving pop-up windows

To move a pop-up window, tap the window's toolbar and drag it to a new location.

Samsung Pay (Galaxy A22)

Introduction

Register cards to Samsung Pay to make both online and offline payments quickly and securely. You can view more information, such as cards that support this feature at www.samsung.com/samsung-pay.

- To make payments with Samsung Pay, the device may be required a connection to a Wi-Fi or mobile network depending on the region.
- This feature may not be available depending on the service provider or model.
- The procedures for the initial setup and card registration may vary depending on the service provider or model.

Setting up Samsung Pay

When running this app for the first time or restart it after performing a data reset, follow the on-screen instructions to complete the initial setup.

1. Launch the Samsung Pay app.
2. Sign in to your Samsung account and read and agree to the terms and conditions.
3. Register your fingerprint and a PIN to use when making payments.

This PIN will be used to verify various actions in Samsung Pay, such as making payments and unlocking the app.

Registering cards

Launch the Samsung Pay app and follow the on-screen instructions to complete your card registration.

Making payments

1. Tap and hold a card image at the bottom of the screen and drag it upwards. Alternatively, launch the Samsung Pay app. Then, on the cards list, swipe to the left or right and select a card to use.

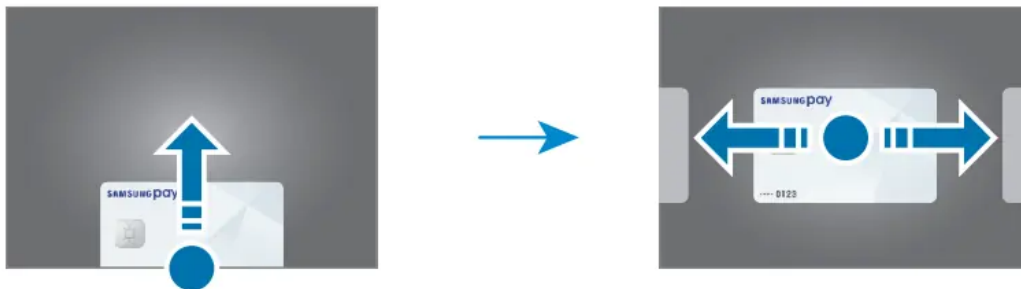

2. Scan your fingerprint or enter the payment PIN you set.
3. Touch the back of your device to the card reader.

When the card reader recognises the card information, the payment will be processed.

- Payments may not be processed depending on your network connection.
- The verification method for payments may vary depending on the card readers.

Cancelling payments

You can cancel payments by visiting the place where you made them.



On the cards list, swipe to the left or right to select the card you used. Follow the on-screen instructions to complete payment cancellation.

Samsung Notes

Create notes by entering text from the keyboard or by handwriting or drawing on the screen. You can also insert images or voice recordings into your notes.

Creating notes

1. Launch the Samsung Notes app, tap , and then create a note.

You can change the input method by tapping  or .

2. When you are finished composing the note, tap the Back button to save it. If you want to save the note in another file format, tap  → Save as file.

Deleting notes

Tap and hold a note to delete and tap Delete.

Radio (Galaxy A22)

Launch the Radio app.

Before you use this app, you must connect an earphone, which serves as the radio antenna. The FM radio scans and saves available stations automatically when running for the first time.

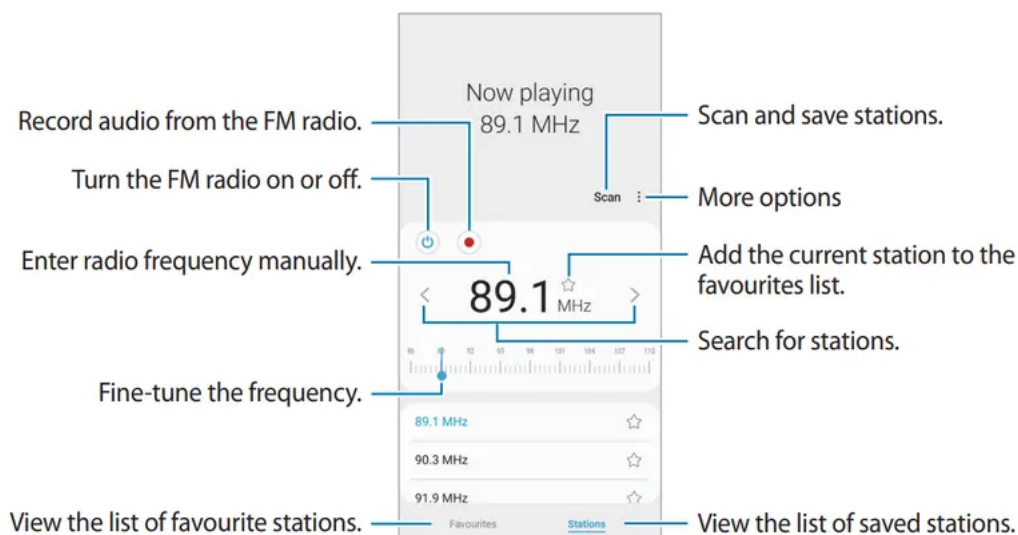

Playing through the speaker

You can listen to the radio through the speaker instead of the connected earphone. Tap  → Play through speaker.



Game Booster (Galaxy A22)

Game Booster lets you play games in a better environment. You can use Game Booster while playing games.



To open the Game Booster panel while playing games, tap  on the navigation bar. If the navigation bar is hidden, drag upwards from the bottom of the screen to show it. If you have set the navigation bar to use Swipe gestures, open the notification panel and tap Tap to open Game Booster.



- : Configure settings for Game Booster.
- Priority mode: Set the device to block incoming calls and all notifications except for alarms to prevent your game from being disturbed.
- Monitoring temperature / Monitoring memory: Set the device to automatically adjust the volume or video frame rate to prevent the device from overheating and to stop apps from running in the background when there is not enough memory.
- Navigation button lock: Hide the buttons on the navigation bar. To display the buttons, tap



-  on the navigation bar.
- Touch protection: Lock the touchscreen while the game is being played. To unlock the touchscreen, drag the lock icon in any direction.
- Screenshot: Capture screenshots.



- Record: Record your game sessions. To stop recording, tap  on the navigation bar.

NOTE

- You can set to open the Game Booster panel from the navigation bar while the navigation bar is set to Swipe gestures. On the Game Booster panel, tap  → Block during game and tap the Navigation gestures switch to activate it.
- Available options may vary depending on the game.

Launching apps in pop-up windows while playing games

You can launch apps in pop-up windows while playing a game. Tap  and select an app from the apps list.

SETTINGS

Introduction

Customise device settings.

Launch the Settings app.

To search for settings by entering keywords, tap . You can also search for settings by selecting a tag under Suggestions.

Samsung account

Sign in to your Samsung account and manage it.

On the Settings screen, tap Samsung account.

Connections

Options

Change settings for various connections, such as the Wi-Fi feature and Bluetooth.

On the Settings screen, tap Connections.

- **Wi-Fi:** Activate the Wi-Fi feature to connect to a Wi-Fi network and access the Internet or other network devices. Refer to Wi-Fi for more information.
- **Bluetooth:** Use Bluetooth to exchange data or media files with other Bluetooth-enabled devices. Refer to Bluetooth for more information.
- **NFC and contactless payments:** Set the device to allow you to read near field communication (NFC) tags that contain information about products. You can also use this feature to make payments and buy tickets for transportation or events after downloading the required apps. Refer to NFC and contactless payments (NFC-enabled models) for more information.
- **Flight mode:** Set the device to disable all wireless functions on your device. You can use only non-network services.

WARNING Follow the regulations provided by the airline and the instructions of aircraft personnel. In cases where it is allowed to use the device, always use it in flight mode.

- **Mobile networks:** Configure your mobile network settings.
- **Data usage:** Keep track of your data usage amount and customise the settings for the limitation. Set the device to automatically disable the mobile data connection when the amount of mobile data you have used reaches your specified limit.

You can activate the data saver feature to prevent some apps running in the background from sending or receiving data. Refer to Data saver for more information.

You can also select apps to always use the mobile data even when your device is connected to a Wi-Fi network. Refer to Mobile data only apps for more information.

- SIM card manager (dual SIM models): Activate your SIM or USIM cards and customise the SIM card settings. Refer to SIM card manager (dual SIM models) for more information.
- Mobile Hotspot and Tethering: Use the device as a mobile hotspot to share the device's mobile data connection with other devices. For more information about the mobile hotspot, refer to Mobile Hotspot.

NOTE You may incur additional charges when using this feature.

- More connection settings: Customise settings to control other features. Refer to More connection settings for more information.

Wi-Fi

Activate the Wi-Fi feature to connect to a Wi-Fi network and access the Internet or other network devices.

Connecting to a Wi-Fi network

1. On the Settings screen, tap Connections → Wi-Fi and tap the switch to activate it.
2. Select a network from the Wi-Fi networks list. Networks with a lock icon require a password.

NOTE

- Once the device connects to a Wi-Fi network, the device will reconnect to that network each time it is available without requiring a password. To prevent the device from connecting to the network automatically, tap  next to the network and tap the Auto reconnect switch to deactivate it.
- If you cannot connect to a Wi-Fi network properly, restart your device's Wi-Fi feature or the wireless router.

Wi-Fi Direct

Wi-Fi Direct connects devices directly via a Wi-Fi network without requiring an access point.

1. On the Settings screen, tap Connections → Wi-Fi and tap the switch to activate it.

2. Tap  → Wi-Fi Direct.

The detected devices are listed.

If the device you want to connect to is not in the list, request that the device turns on its Wi-Fi Direct feature.

3. Select a device to connect to.

The devices will be connected when the other device accepts the Wi-Fi Direct connection request.

To end the device connection, select the device to disconnect from the list.

Bluetooth

Use Bluetooth to exchange data or media files with other Bluetooth-enabled devices.

- Samsung is not responsible for the loss, interception, or misuse of data sent or received via Bluetooth.
- Always ensure that you share and receive data with devices that are trusted and properly secured. If there are obstacles between the devices, the operating distance may be reduced.
- Some devices, especially those that are not tested or approved by the Bluetooth SIG, may be incompatible with your device.
- Do not use the Bluetooth feature for illegal purposes (for example, pirating copies of files or illegally tapping communications for commercial purposes). Samsung is not responsible for the repercussion of illegal use of the Bluetooth feature.

Pairing with other Bluetooth devices

1. On the Settings screen, tap Connections → Bluetooth and tap the switch to activate it.

The detected devices will be listed.

2. Select a device to pair with.

If the device you want to pair with is not on the list, set the device to enter Bluetooth pairing mode. Refer to the other device's user manuals.

NOTE Your device is visible to other devices while the Bluetooth settings screen is open.

3. Accept the Bluetooth connection request on your device to confirm.

The devices will be connected when the other device accepts the Bluetooth connection request.

To unpair the devices, tap  next to the device name to unpair and tap Unpair.

Sending and receiving data

Many apps support data transfer via Bluetooth. You can share data, such as contacts or media files, with other Bluetooth devices. The following actions are an example of sending an image to another device.

1. Launch the Gallery app and select an image.

2. Tap  → Bluetooth and select a device to transfer the image to.

If the device you want to pair with is not in the list, request that the device turns on its visibility option.

3. Accept the Bluetooth connection request on the other device.

NFC and contactless payments (NFC-enabled models)

Your device allows you to read near field communication (NFC) tags that contain information about products. You can also use this feature to make payments and buy tickets for transportation or events after downloading the required apps.

WARNING The device contains a built-in NFC antenna. Handle the device carefully to avoid damaging the NFC antenna.

Reading information from NFC tags

Use the NFC feature to read product information from NFC tags.

1. On the Settings screen, tap Connections and tap the NFC and contactless payments switch to activate it.

2. Place the NFC antenna area on the back of your device near an NFC tag.

The information from the tag appears.

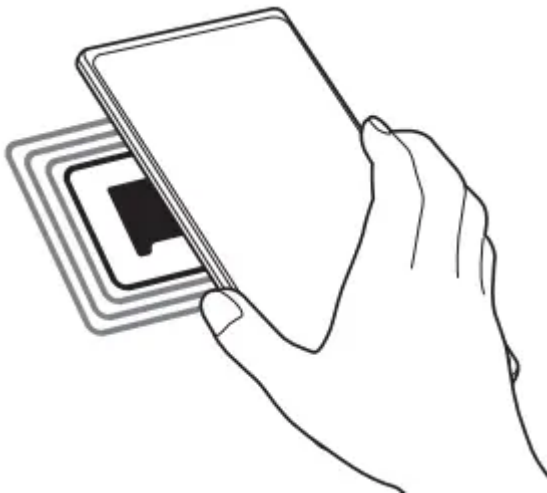

NOTE Ensure that the device's screen is turned on and unlocked. Otherwise, the device will not read NFC tags or receive data.

Making payments with the NFC feature

Before you can use the NFC feature to make payments, you must register for the mobile payment service. To register or get more information about the service, contact your service provider.

1. On the Settings screen, tap Connections and tap the NFC and contactless payments switch to activate it.

2. Touch the NFC antenna area on the back of your device to the NFC card reader.

To set the default payment app, open the Settings screen and tap Connections → NFC and contactless payments → Contactless payments → Payment, and then select an app.

NOTE The payment services list may not include all available payment apps.

Data saver

Reduce your data usage by preventing some apps running in the background from sending or receiving data.

On the Settings screen, tap Connections → Data usage → Data saver and tap the switch to activate it.

When the data saver feature is activated, the  icon will appear on the status bar.



NOTE To select apps to use data without restriction, tap Allowed to use data while Data saver is on and select apps.

Mobile data only apps

Select apps to always use the mobile data even when your device is connected to a Wi-Fi network.

For example, you can set the device to use only mobile data for apps that you want to keep secure or streaming apps that can be disconnected. Even if you do not deactivate the Wi-Fi feature, the apps will launch using the mobile data.

On the Settings screen, tap Connections → Data usage → Mobile data only apps, tap the switch to activate it, and then tap the switches next to the apps you want.

NOTE You may incur additional charges when using this feature.

Mobile Hotspot

Use your device as a mobile hotspot to share your device's mobile data connection with other devices.

1. On the Settings screen, tap Connections → Mobile Hotspot and Tethering → Mobile Hotspot.

2. Tap the switch to activate it. The  icon appears on the status bar.

You can change the level of security and the password by tapping Configure.

3. On the other device's screen, search for and select your device from the Wi-Fi networks list.

Alternatively, tap QR code on the mobile hotspot screen and scan the QR code with the other device.

NOTE

- If the mobile hotspot is not found, on your device, tap Configure and set Band to 2.4 GHz, tap Advanced, and then tap the Hidden network switch to deactivate it.
- If you activate the Auto Hotspot feature, you can share your device's mobile data connection with other devices signed in to your Samsung account.

More connection settings

Customise settings to control other connection features.

On the Settings screen, tap Connections → More connection settings.

- Nearby device scanning: Set the device to scan for nearby devices to connect to.
- Printing: Configure settings for printer plug-ins installed on the device. You can search for available printers or add one manually to print files. Refer to Printing for more information.
- VPN: Set up virtual private networks (VPNs) on your device to connect to a school or company's private network.
- Private DNS: Set the device to use the security enhanced private DNS.
- Ethernet: When you connect an Ethernet adaptor, you can use a wired network and configure network settings.

Printing

Configure settings for printer plug-ins installed on the device. You can connect the device to a printer via Wi-Fi or Wi-Fi Direct, and print images or documents.

NOTE Some printers may not be compatible with the device.

Adding printer plug-ins

Add printer plug-ins for printers you want to connect the device to.

1. On the Settings screen, tap Connections → More connection settings → Printing → Download plugin.

2. Select a printer plug-in and install it.
3. Select the installed printer plug-in.

The device will automatically search for printers that are connected to the same Wi-Fi network as your device.

4. Select a printer to add.

NOTE To add printers manually, tap  → Add printer.

Printing content

While viewing content, such as images or documents, access the options list, tap Print →  → All printers, and then select a printer.

NOTE Printing methods may vary depending on the content type.

Sounds and vibration

Options

Change settings for various sounds on the device.

On the Settings screen, tap Sounds and vibration.

- Sound mode: Set the device to use sound mode, vibration mode, or silent mode.
- Vibrate while ringing: Set the device to vibrate and play a ringtone for incoming calls.
- Temporary mute: Set the device to use silent mode for a certain period.
- Ringtone: Change the call ringtone.
- Notification sound: Change the notification sound.
- Volume: Adjust the device's volume level.
- Call vibration pattern: Change the call vibration pattern.
- Notification vibration pattern: Change the notification vibration pattern.
- Vibration intensity: Adjust the force of the vibration notification.
- System sound/vibration control: Set the device to sound or vibrate for actions, such as controlling the touchscreen.
- Sound quality and effects: Set the device's sound quality and effects. Refer to Sound quality and effects for more information.
- Separate app sound: Set the device to play media sound from a specific app separately on the other audio device. Refer to Separate app sound for more information.

NOTE Some features may not be available depending on the model.

Sound quality and effects

Set the device's sound quality and effects.

On the Settings screen, tap Sounds and vibration → Sound quality and effects.

- **Dolby Atmos:** Select a surround sound mode optimised for various types of audio, such as movies, music, and voice. With Dolby Atmos, you can experience moving audio sounds that flow all around you.
- **Dolby Atmos for gaming:** Experience the Dolby Atmos sound optimised for games while playing games.
- **Equaliser:** Select an option for a specific music genre and enjoy optimised sound.
- **Adapt sound:** Set the best sound for you.

NOTE

- Some features may not be available depending on the model.
- Depending on the model, you must connect an earphone to use some features.

Separate app sound

Set the device to play media sound from a specific app on the connected Bluetooth speaker or headset.

For example, you can listen to the Navigation app through your device's speaker while listening to playback from the Music app through the vehicle's Bluetooth speaker.

1. On the Settings screen, tap Sounds and vibration → Separate app sound and tap the switch to activate it.
2. Select an app to play media sounds separately and tap the Back button.
3. Select a device for playing the selected app's media sound.

Notifications

Change the notification settings.

On the Settings screen, tap Notifications.

- **Notification pop-up style:** Select a notification pop-up style and change the settings.
- **Recently sent:** View the apps that received recent notifications and change the notification settings. To customise notification settings for more apps, tap More → ▼ → All and select an app from the apps list.
- **Do not disturb:** Set the device to mute all sounds except for allowed exceptions.

- Advanced settings: Configure advanced settings for notifications.
-

Display

Options

Change the display and the Home screen settings.

On the Settings screen, tap Display.

- Light / Dark: Activate or deactivate dark mode.
- Dark mode settings: Reduce eye strain by applying the dark theme when using the device at night or in a dark place. You can set a schedule for applying dark mode.
The dark theme may not be applied in some apps.
- Brightness: Adjust the brightness of the display.
- Adaptive brightness: Set the device to keep track of your brightness adjustments and apply them automatically in similar lighting conditions.
- Motion smoothness: Change the refresh rate of the screen. When a high refresh rate is set, the screen will scroll more smoothly. Refer to Motion smoothness for more information.
- Eye comfort shield: Reduce eye strain by limiting the amount of blue light emitted by the screen. You can set a schedule for applying this feature.
- Screen mode: Change the screen mode to adjust the display's colour and contrast. Refer to Changing the screen mode or adjusting the display colour (Galaxy A22) for more information.
- Font size and style: Change the font size and style.
- Screen zoom: Make the items on the screen larger or smaller.
- Full screen apps: Select apps to use with the full screen aspect ratio.
- Screen timeout: Set the length of time the device waits before turning off the display's backlight.
- Edge panels: Change the settings for the Edge panel.
- Navigation bar: Change the navigation bar settings. Refer to Navigation bar (soft buttons) for more information.
- Accidental touch protection: Set the device to prevent the screen from detecting touch input when it is in a dark place, such as a pocket or bag.
- Touch sensitivity: Increase the touch sensitivity of the screen for use with screen protectors.

- Show charging information: Set the device to display the charging information, such as the remaining battery percentage when the screen is off.
- Screen saver: Set the device to launch a screen saver when the device is charging.

NOTE Some features may not be available depending on the model.

Motion smoothness

The refresh rate is the number of times the screen is refreshed every second. Use a high refresh rate to prevent the screen from flickering when switching between screens. The screen will scroll more smoothly. When you select a standard refresh rate, you can use the battery longer.

1. On the Settings screen, tap Display → Motion smoothness.
2. Select a refresh rate.
 - High: Get smoother animations and scrolling by automatically adjusting your screen refresh rate up to 90 Hz.
 - Standard: Use a standard refresh rate in normal situations to conserve battery power.

Changing the screen mode or adjusting the display colour (Galaxy A22)

Change the screen mode or adjust the display colour to your preference.

Changing the screen mode

On the Settings screen, tap Display → Screen mode and select a mode you want.

- Vivid: This optimises the colour range, saturation, and sharpness of your display. You can also adjust the display colour balance by colour value.
- Natural: This adjusts the screen to a natural tone.

NOTE

- You can adjust the display colour only in Vivid mode.
- Vivid mode may not be compatible with third-party apps.

Optimising the full screen colour balance

Optimise the display colour by adjusting the colour tones to your preference.

On the Settings screen, tap Display → Screen mode → Vivid and adjust the colour adjustment bar under White balance.

When you drag the colour adjustment bar towards Cool, the blue colour tone will increase.

When you drag the bar towards Warm, the red colour tone will increase.



Adjusting the screen tone by colour value

Increase or lower certain colour tones by adjusting the Red, Green, or Blue value individually.

1. On the Settings screen, tap Display → Screen mode → Vivid.
2. Tap Advanced settings.
3. Adjust the R (Red), G (Green), or B (Blue) colour bar to your preference.

The screen tone will be adjusted.

Wallpaper

Change the wallpaper settings for the Home screen and the locked screen.

On the Settings screen, tap Wallpaper.

Themes

Apply various themes to the device to change the visual elements of the Home screen, locked screen, and icons.

On the Settings screen, tap Themes.

Home screen

Configure settings for the Home screen, such as the screen layout.

On the Settings screen, tap Home screen.

Lock screen

Options

Change the settings for the locked screen.

On the Settings screen, tap Lock screen.

- Screen lock type: Change the screen lock method.
- Smart Lock: Set the device to unlock itself when trusted locations or devices are detected. Refer to Smart Lock for more information.
- Secure lock settings: Change screen lock settings for the selected lock method.
- Always On Display: Set the device to display information while the screen is turned off. Refer to Always On Display (Galaxy A22) for more information.
- Wallpaper services: Set the device to use wallpaper services such as Dynamic Lock screen.
- Clock style: Change the type and colour of the clock on the locked screen.
- Roaming clock: Change the clock to show both the local and home time zones on the locked screen when roaming.
- Widgets: Change the settings of the items displayed on the locked screen.
- Contact information: Set the device to show contact information, such as your email address, on the locked screen.
- Notifications: Set how to show notifications on the locked screen.
- Shortcuts: Select apps to display shortcuts to them on the locked screen.
- About Lock screen: View the Lock screen version and legal information.

NOTE The available options may vary depending on the screen lock method selected.

Smart Lock

You can set the device to unlock itself and remain unlocked when trusted locations or devices are detected.

For example, if you have set your home as a trusted location, when you get home your device will detect the location and automatically unlock itself.

On the Settings screen, tap Lock screen → Smart Lock and follow the on-screen instructions to complete the setup.

NOTE

- This feature will be available to use after you set a screen lock method.
- If you do not use your device for four hours or when you turn on the device, you must unlock the screen using the pattern, PIN, or password you set.

Always On Display (Galaxy A22)

You can view information, such as the clock or calendar, or control music playback on the screen when it is turned off.

You can also check notifications for new messages or missed calls.

The Always On Display is set to appear only when you tap the screen. To change the settings to make it appear continuously or during a set time, on the Settings screen, tap Lock screen → Always On Display, and then select a mode you want.

NOTE The brightness of the Always On Display may change automatically depending on the lighting conditions.

Opening notifications on the Always On Display

When you receive message, missed call, or app notifications, notification icons will appear on the Always On Display. Double-tap a notification icon to view its notification.

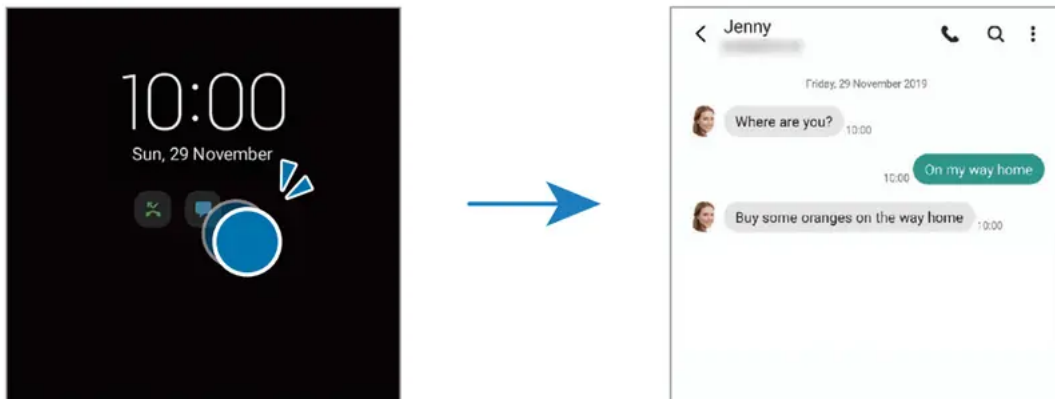

NOTE If the screen is locked, you must unlock it to view notifications.

Deactivating the Always On Display feature

Open the notification panel, swipe downwards, and then tap  (Always On Display) to

deactivate it. If you cannot find  (Always On Display) on the quick panel, tap 

Alternatively, on the Settings screen, tap Lock screen, and then tap the Always On Display switch to deactivate it.

Biometrics and security

Options

Change the settings for securing the device.

On the Settings screen, tap Biometrics and security.

- Face recognition: Set the device to unlock the screen by recognising your face.
- Fingerprints: Register your fingerprints to unlock the screen. Refer to Fingerprint recognition for more information.
- More biometrics settings: Change the settings for biometric data.
- Google Play Protect: Set the device to check for harmful apps and behaviour and warn about potential harm and remove them.
- Security update: View the version of your device's software and check for updates.
- Google Play system update: View the Google Play system version and check for updates.
- Find My Mobile: Activate or deactivate the Find My Mobile feature. Access the Find My Mobile website (findmymobile.samsung.com) to track and control your lost or stolen device.
- Private Share: Share files with others securely using blockchain technology.
- Install unknown apps: Set the device to allow the installation of apps from unknown sources.
- Encrypt SD card: Set the device to encrypt files on a memory card.

WARNING If you reset your device to the factory defaults with this setting enabled, the device will not be able to read your encrypted files. Disable this setting before resetting the device.

- Other security settings: Configure additional security settings.

Face recognition

You can set the device to unlock the screen by recognising your face.

- If you use your face as a screen lock method, your face cannot be used to unlock the screen for the first time after turning on the device. To use the device, you must unlock the screen using the pattern, PIN, or password you set when registering the face. Be careful not to forget your pattern, PIN, or password.
- If you change the screen lock method to Swipe or None, which are not secure, all of your biometric data will be deleted. If you want to use your biometric data in apps or features, you must register your biometric data again.

WARNING Precautions for using face recognition

Before using the face recognition to unlock your device, keep the following precautions in mind.

- Your device could be unlocked by someone or something that looks like your image.
- Face recognition is less secure than Pattern, PIN, or Password.

For better face recognition

Consider the following when using face recognition:

- Consider the conditions when registering, such as wearing glasses, hats, masks, beards, or heavy makeup
- Ensure that you are in a well-lit area and that the camera lens is clean when registering
- Ensure your image is not blurry for better match results

Registering your face

For better face registration, register your face indoors and out of direct sunlight.

1. On the Settings screen, tap Biometrics and security → Face recognition.
2. Read the on-screen instructions and tap Continue.
3. Set a screen lock method.
4. Select whether you are wearing glasses or not and tap Continue. (Galaxy A22)
5. Position your face inside the frame on the screen. The camera will scan your face.

NOTE

- If unlocking the screen with your face is not working properly, tap Remove face data to remove your registered face and register your face again.
- To enhance the face recognition, tap Add alternative look and add an alternate appearance.

Unlocking the screen with your face

You can unlock the screen with your face instead of using a pattern, PIN, or password.

1. On the Settings screen, tap Biometrics and security → Face recognition.
2. Unlock the screen using the preset screen lock method.
3. Tap the Face unlock switch to activate it.
4. On the locked screen, look at the screen.

When your face is recognised, you can unlock the screen without using any additional screen lock method. If your face is not recognised, use the preset screen lock method.

Deleting the registered face data

You can delete face data that you have registered.

1. On the Settings screen, tap Biometrics and security → Face recognition.
2. Unlock the screen using the preset screen lock method.
3. Tap Remove face data → Remove.

Once the registered face is deleted, all the related features will also be deactivated.

Fingerprint recognition

In order for fingerprint recognition to function, your fingerprint information needs to be registered and stored in your device.

NOTE

- This feature may not be available depending on the service provider or model.
- Fingerprint recognition uses the unique characteristics of each fingerprint to enhance the security of your device. The likelihood of the fingerprint sensor confusing two different

fingerprints is very low. However, in rare cases where separate fingerprints are very similar the sensor may recognise them as identical.

- If you use your fingerprint as a screen lock method, your fingerprint cannot be used to unlock the screen for the first time after turning on the device. To use the device, you must unlock the screen using the pattern, PIN, or password you set when registering the fingerprint. Be careful not to forget your pattern, PIN, or password.
- If your fingerprint is not recognised, unlock the device using the pattern, PIN, or password you set when registering the fingerprint, and then re-register your fingerprints. If your pattern, PIN, or password is forgotten, you will not be able to use the device if you do not reset it. Samsung is not responsible for any data loss or inconvenience caused by forgotten unlock codes.
- If you change the screen lock method to Swipe or None, which are not secure, all of your biometric data will be deleted. If you want to use your biometric data in apps or features, you must register your biometric data again.

For better fingerprint recognition

When you scan your fingerprints on the device, be aware of the following conditions that may affect the feature's performance:

- The device may not recognise fingerprints that are affected by wrinkles or scars.
- The device may not recognise fingerprints from small or thin fingers.
- To improve recognition performance, register fingerprints of the hand used most often to perform tasks on the device.
- The Side key has a built-in fingerprint recognition sensor. Ensure that the fingerprint recognition sensor is not scratched or damaged by metal objects, such as coins, keys, and necklaces.
- Covering the fingerprint recognition sensor with protective films, stickers, or other accessories may decrease the fingerprint recognition rate. If the fingerprint recognition sensor is initially covered with a protective film, remove it before using the fingerprint recognition sensor.
- Ensure that the fingerprint recognition sensor and your fingers are clean and dry.
- If you bend your finger or use a fingertip, the device may not recognise your fingerprints.
- Make sure to cover the entire fingerprint recognition sensor with your finger.
- In dry environments, static electricity can build up in the device. Avoid using this feature in dry environments or before using the feature, discharge static electricity by touching a metal object.

Registering fingerprints

1. On the Settings screen, tap Biometrics and security → Fingerprints.

2. Read the on-screen instructions and tap Continue.

3. Set a screen lock method.

4. Place your finger on the Side key. After the device detects your finger, lift it up and place it on the Side key again.

Repeat this action until the fingerprint is registered.

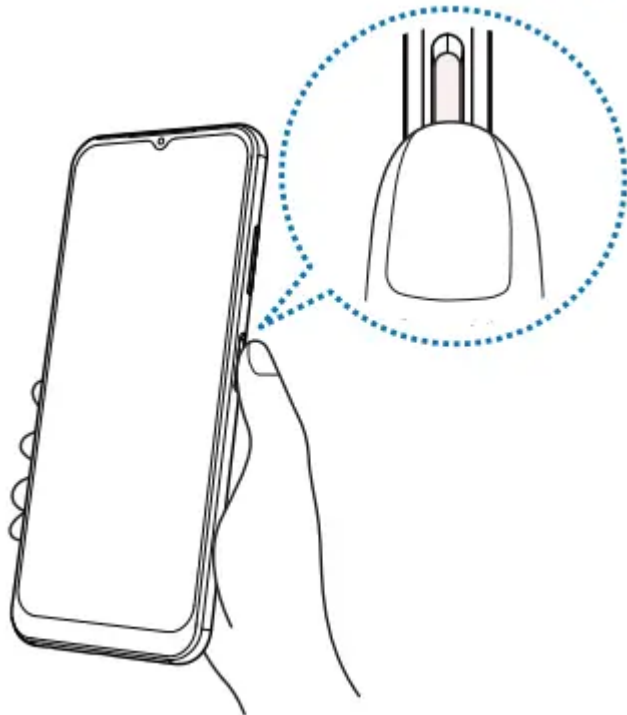

5. When you are finished registering your fingerprints, tap Done.

You can check whether your fingerprint is registered by tapping Check added fingerprints.

Unlocking the screen with your fingerprints

You can unlock the screen with your fingerprint instead of using a pattern, PIN, or password.

1. On the Settings screen, tap Biometrics and security → Fingerprints.

2. Unlock the screen using the preset screen lock method.

3. Tap the Fingerprint unlock switch to activate it.

4. On the locked screen, place your finger on the fingerprint recognition sensor and scan your fingerprint.

Deleting registered fingerprints

You can delete registered fingerprints.

1. On the Settings screen, tap Biometrics and security → Fingerprints.

2. Unlock the screen using the preset screen lock method.

3. Select a fingerprint to delete and tap Remove.

Privacy

Change the settings for privacy.

On the Settings screen, tap Privacy.

- **Permission manager:** View the list of features and apps that have permission to use them. You can also edit the permission settings.
- **Samsung:** Manage personal data related to your Samsung account and change the settings for Customisation Service.
- **Google:** Configure advanced settings for privacy.

NOTE Some features may not be available depending on the service provider or model.

Advanced features

Options

Activate advanced features and change the settings that control them.

On the Settings screen, tap Advanced features.

- **Continue apps on other devices:** Use your device's apps on other devices signed in to your Samsung account.
- **Android Auto:** Connect your device to a vehicle and control some of your device's features on the vehicle's display.
- **Quick Share:** Change the Quick Share settings. Refer to Quick Share for more information.
- **Side key:** Select an app or feature to launch using the Side key. Refer to Setting the Side key for more information.
- **Motions and gestures:** Activate the motion feature and configure settings. Refer to Motions and gestures for more information.
- **One-handed mode:** Activate one-handed operation mode for your convenience when using the device with one hand.
- **Screenshots:** Change the settings for screenshots.
- **Show contacts when sharing content:** Set the device to display the people you contacted on the sharing options panel to allow you to share content directly.
- **Game Launcher:** Activate the Game Launcher. Refer to Game Launcher for more information.
- **Dual Messenger:** Install the second app and use two separate accounts for the same messenger app. Refer to Dual Messenger for more information.

- Send SOS messages: Set the device to send help messages by pressing the Side key several times.

NOTE Some features may not be available depending on the service provider or model.

Motions and gestures

Activate the motion feature and configure settings.

On the Settings screen, tap Advanced features → Motions and gestures.

- Lift to wake: Set the device to turn on the screen when you pick it up.
- Double tap to turn on screen: Set the device to turn on the screen by double-tapping anywhere on the screen while the screen is turned off.
- Double tap to turn off screen: Set the device to turn off the screen by double-tapping an empty area on the Home screen or the locked screen.
- Keep screen on while viewing: Set the device to prevent the display from turning off while you are looking at it.
- Alert when phone picked up: Set the device to alert you if you have missed calls or new messages when you pick up the device.

NOTE This feature may not work if the screen is turned on or the device is not on a flat surface.

- Mute with gestures / Turn over to mute: Set the device to mute certain sounds by using motions or gestures.
- Finger sensor gestures: Set the device to open or close the notification panel when you swipe upwards or downwards on the fingerprint recognition sensor. This feature is not available when the sensor is detecting your fingerprint.
- Palm swipe to capture: Set the device to capture a screenshot when you swipe your hand to the left or right across the screen. You can view the captured images in Gallery. It is not possible to capture a screenshot while using some apps and features.

NOTE

- Some features may not be available depending on the model.
- Excessive shaking or an impact to the device may cause an unintended input for some features using sensors.

Dual Messenger

Install the second app and use two separate accounts for the same messenger app.

1. On the Settings screen, tap Advanced features → Dual Messenger. Supported apps will appear.
2. Tap the switch of an app to install the second app.

The second app will be installed. The second app's icon will be displayed with .



NOTE

- The Dual Messenger feature may not be available depending on the app.
- Some features of the app may be limited for the second app.

Uninstalling a second app

1. On the Settings screen, tap Advanced features → Dual Messenger.
 2. Tap the switch of the app you want to uninstall and tap Uninstall.
- All data related to the second app will be deleted.

NOTE If you uninstall the first app, the second app will also be deleted.

Battery and device care

Introduction

The device care feature provides an overview of the status of your device's battery, storage, memory, and system security. You can also automatically optimise the device with a tap of your finger.

Optimising your device

On the Settings screen, tap Battery and device care → Optimise now.

The quick optimisation feature improves device performance through the following actions.

- Closing apps running in the background.
- Managing abnormal battery usage.
- Scanning for crashed apps and malware.

Using the auto optimisation feature

You can set the device to perform auto optimisation when your device is not in use. Tap → Automation → Auto optimise daily and tap the switch to activate it. If you want to set the time to perform auto optimisation, tap Time.

Battery

Check the remaining battery power and time to use the device. For devices with low battery levels, conserve battery power by activating power saving features.

On the Settings screen, tap Battery and device care → Battery.

- Power saving mode: Activate power saving mode to extend the battery's usage time.
- Background usage limits: Limit battery usage for apps that you do not use often.
- More battery settings: Configure advanced settings for the battery.

NOTE

- The usage time left shows the time remaining before the battery power runs out. Usage time left may vary depending on your device settings and operating conditions.
- You may not receive notifications from some apps that use power saving mode.

Storage

Check the status of the used and available memory.

On the Settings screen, tap Battery and device care → Storage. To delete files or uninstall apps that you do not use anymore, select a category. Then, tap and hold, or select, an item and tap Delete or Uninstall.

- The actual available capacity of the internal memory is less than the specified capacity because the operating system and default apps occupy part of the memory. The available capacity may change when you update the device.
- You can view the available capacity of the internal memory in the Specification section for your device on the Samsung website.

Storage

Check the status of the used and available memory. On the Settings screen, tap Battery and device care → Storage. To delete files or uninstall apps that you do not use anymore, select a category. Then, tap and hold, or select, an item and tap Delete or Uninstall.

NOTE

- The actual available capacity of the internal memory is less than the specified capacity because the operating system and default apps occupy part of the memory. The available capacity may change when you update the device.
- You can view the available capacity of the internal memory in the Specification section for your device on the Samsung website.

Memory

On the Settings screen, tap Battery and device care → Memory. To speed up your device by stopping apps running in the background, tick apps from the apps list, and tap Clean now.

Device protection

Check the device's security status. This feature scans your device for malware. On the Settings screen, tap Battery and device care → Device protection → Scan phone.

Ultra data saving

Monitor and reduce your mobile data usage by preventing background apps from using the mobile data connection. You can also use the data compression feature to compress Internet data, such as images, videos, and webpages, accessed via the mobile network.

On the Settings screen, tap Battery and device care → Ultra data saving, and then tap the switch to activate it.

NOTE

- This feature may not be available depending on the service provider or model.
- Some webpages or content may not be available when this feature is activated, depending on the service provider or the mobile network conditions.

TROUBLESHOOTING

Before contacting a Samsung Service Centre, please attempt the following solutions. Some situations may not apply to your device.

You can also use Samsung Members to solve any problems you might encounter while using your device.

When you turn on your device or while you are using the device, it prompts you to enter one of the following codes:

- Password: When the device lock feature is enabled, you must enter the password you set for the device.
- PIN: When using the device for the first time or when the PIN requirement is enabled, you must enter the PIN supplied with the SIM or USIM card. You can disable this feature by using the Lock SIM card menu.
- PUK: Your SIM or USIM card is blocked, usually as a result of entering your PIN incorrectly several times. You must enter the PUK supplied by your service provider.
- PIN2: When you access a menu requiring the PIN2, you must enter the PIN2 supplied with the SIM or USIM card. For more information, contact your service provider.

Your device displays network or service error messages

- When you are in areas with weak signals or poor reception, you may lose reception. Move to another area and try again. While moving, error messages may appear repeatedly.
- You cannot access some options without a subscription. For more information, contact your service provider.

Your device does not turn on

When the battery is completely discharged, your device will not turn on. Fully charge the battery before turning on the device.

The touchscreen responds slowly or improperly

- If you attach a screen protector or optional accessories to the touchscreen, the touchscreen may not function properly.
- If you are wearing gloves, if your hands are not clean while touching the touchscreen, or if you tap the screen with sharp objects or your fingertips, the touchscreen may malfunction.
- The touchscreen may malfunction in humid conditions or when exposed to water.
- Restart your device to clear any temporary software bugs.
- Ensure that your device software is updated to the latest version.
- If the touchscreen is scratched or damaged, visit a Samsung Service Centre.

Your device freezes or encounters a fatal error

Try the following solutions. If the problem is still not resolved, contact a Samsung Service Centre.

Restarting the device

If your device freezes or hangs, you may need to close apps or turn off the device and turn it on again.

Forcing restart

If your device is frozen and unresponsive, press and hold the Side key and the Volume Down key simultaneously for more than 7 seconds to restart it.

Resetting the device

If the methods above do not solve your problem, perform a factory data reset.

Launch the Settings app and tap General management → Reset → Factory data reset → Reset → Delete all. Before performing the factory data reset, remember to make backup copies of all important data stored in the device.

Calls are not connected

- Ensure that you have accessed the right cellular network.
- Ensure that you have not set call barring for the phone number you are dialling.
- Ensure that you have not set call barring for the incoming phone number.

Others cannot hear you speaking on a call

- Ensure that you are not covering the built-in microphone.
- Ensure that the microphone is close to your mouth.
- If using an earphone. ensure that it is properly connected.

Sound echoes during a call

Adjust the volume by pressing the Volume key or move to another area.

A cellular network or the Internet is often disconnected or audio quality is poor

- Ensure that you are not blocking the device's internal antenna.
- When you are in areas with weak signals or poor reception, you may lose reception. You may have connectivity problems due to issues with the service provider's base station. Move to another area and try again.
- When using the device while moving, wireless network services may be disabled due to issues with the service provider's network.

The battery does not charge properly (For Samsung-approved chargers)

- Ensure that the charger is connected properly.
- Visit a Samsung Service Centre and have the battery replaced.

The battery depletes faster than when first purchased

- When you expose the device or the battery to very cold or very hot temperatures. the useful charge may be reduced.
- Battery consumption will increase when you use certain features or apps. such as GPS. games. or the Internet.
- The battery is consumable and the useful charge will get shorter over time.

Error messages appear when launching the camera

Your device must have sufficient available memory and battery power to operate the camera app. If you receive error messages when launching the camera. try the following:

- Charge the battery.
- Free some memory by transferring files to a computer or deleting files from your device.
- Restart the device. If you are still having trouble with the camera app after trying these tips, contact a Samsung Service Centre.

Picture quality is poorer than the preview

- The quality of your pictures may vary, depending on the surroundings and the photography techniques you use.
- If you take pictures in dark areas, at night, or indoors, image noise may occur or images may be out of focus.

Error messages appear when opening multimedia files

If you receive error messages or multimedia files do not play when you open them on your device, try the following:

- Free some memory by transferring files to a computer or deleting files from your device.
- Ensure that the music file is not Digital Rights Management (DRM)-protected. If the file is DRM-protected, ensure that you have the appropriate licence or key to play the file.
- Ensure that the file formats are supported by the device. If a file format is not supported, such as DivX or AC3, install an app that supports it. To confirm the file formats that your device supports, visit the Samsung website.
- Your device supports pictures and videos captured with the device. Pictures and videos captured by other devices may not work properly.
- Your device supports multimedia files that are authorised by your network service provider or providers of additional services. Some content circulated on the Internet, such as ringtones, videos, or wallpapers, may not work properly.

Bluetooth is not working well

If another Bluetooth device is not located or there are connection problems or performance malfunctions, try the following:

- Ensure that the device you wish to connect with is ready to be scanned or connected to.
- Ensure that your device and the other Bluetooth device are within the maximum Bluetooth range (10 m).
- On your device, launch the Settings app, tap Connections, and then tap the Bluetooth switch to re-activate it.

- On your device, launch the Settings app, tap General management → Reset → Reset network settings → Reset settings → Reset to reset network settings. You may lose registered information when performing the reset.

If the tips above do not solve the problem, contact a Samsung Service Centre.

The screen brightness adjustment bar does not appear on the notification panel

Open the notification panel by dragging the status bar downwards, and then drag the notification



panel downwards. Tap → Quick panel layout and tap the Show brightness control above notifications switch to activate it.

A connection is not established when you connect the device to a computer

- Ensure that the USB cable you are using is compatible with your device.
- Ensure that you have the proper driver installed and updated on your computer.

Your device cannot find your current location

GPS signals may be obstructed in some locations, such as indoors. Set the device to use Wi-Fi or a mobile network to find your current location in these situations.

Data stored in the device has been lost

Always make backup copies of all important data stored in the device. Otherwise, you cannot restore data if it is corrupted or lost. Samsung is not responsible for the loss of data stored in the device.

A small gap appears around the outside of the device case

- This gap is a necessary manufacturing feature and some minor rocking or vibration of parts may occur.
- Over time, friction between parts may cause this gap to expand slightly.

There is not enough space in the device's storage

Delete unnecessary data, such as cache, using the device care feature or manually delete unused apps or files to free up storage space.

The Home button does not appear

The navigation bar containing the Home button may disappear while using certain apps or features. To view the navigation bar, drag upwards from the bottom of the screen.

REMOVING THE BATTERY

- To remove the battery, contact an authorised service centre. To obtain battery removal instructions, please visit www.samsung.com/global/ecodesignenergy.
- For your safety, you must not attempt to remove the battery. If the battery is not properly removed, it may lead to damage to the battery and device, cause personal injury, and/or result in the device being unsafe.
- Samsung does not accept liability for any damage or loss (whether in contract or tort, including negligence) which may arise from failure to precisely follow these warnings and instructions, other than death or personal injury caused by Samsung's negligence.

Warning

This content is compiled from multiple sources and is provided for reference purposes only. It may not be complete or fully applicable to all situations. If you are unable to resolve your issue, please contact the product manufacturer or an authorized service provider for official support.