

Before you do your first wash

Before you start, it is a good idea to go through the following checklist:

1. Have the packaging and transit bolts been removed?
2. Is the drain hose threaded through the 'U bend' (with no more than 20mm extended) and hooked into your standpipe or tub, or attached to a spigot?
3. Is the cold hose connected to the cold valve? Has the tap been turned on and connected to the washer dryer?
4. Is the machine correctly levelled? Are the feet locked and cabinet corners clear of the floor and walls?
5. Has the power cord been connected to an appropriate power supply and the power turned on?
6. Has the installation test cycle been performed?
7. We recommend you complete your first cycle with a half-load amount of detergent and without a load in order to remove any residues remaining in the machine from the manufacturing process.

IMPORTANT! You must ensure all 4 transit bolts have been removed from your washer dryer before you start using it. If the transit bolts are not removed, they will damage your washer dryer and **YOUR MANUFACTURER'S WARRANTY WILL BE COMPROMISED.**

GETTING STARTED QUICKLY

WM1490F model only

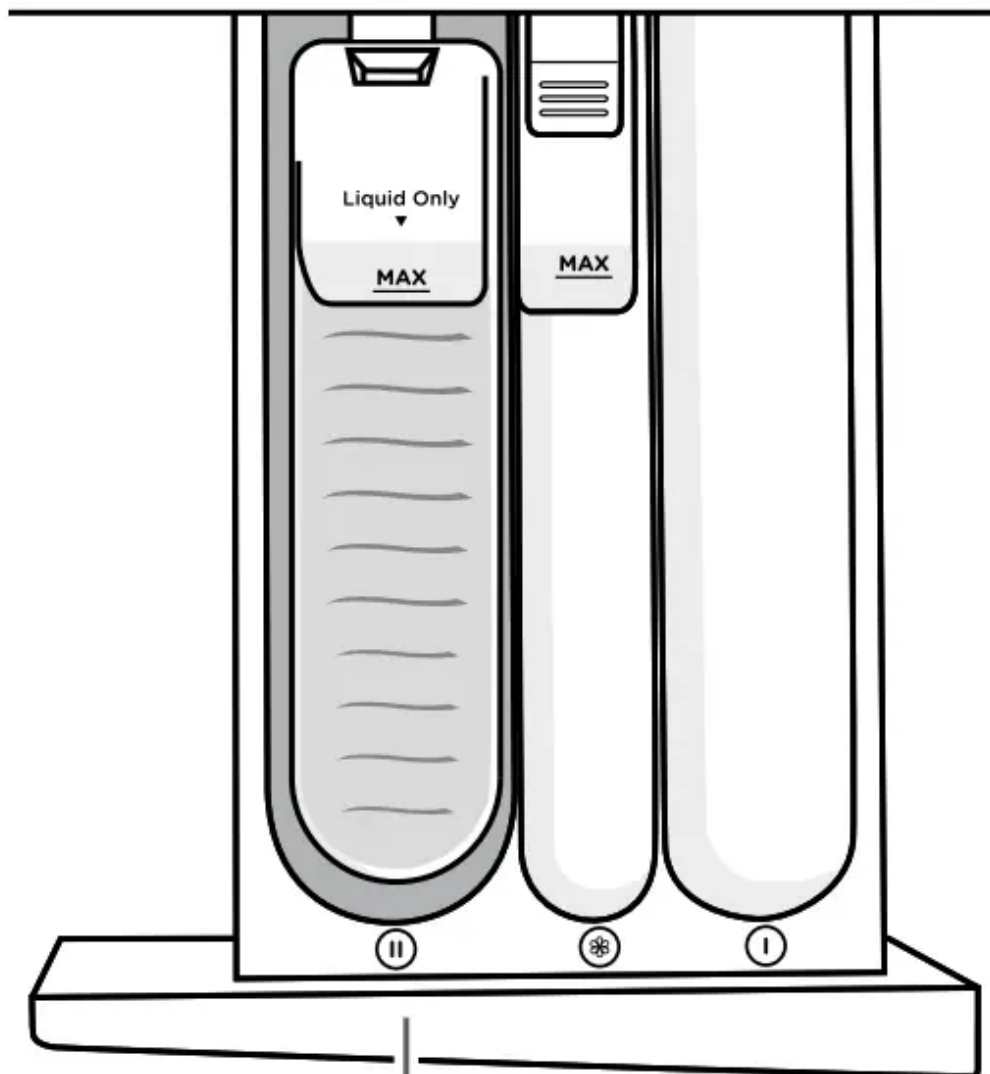

Liquid detergent in
compartment marked



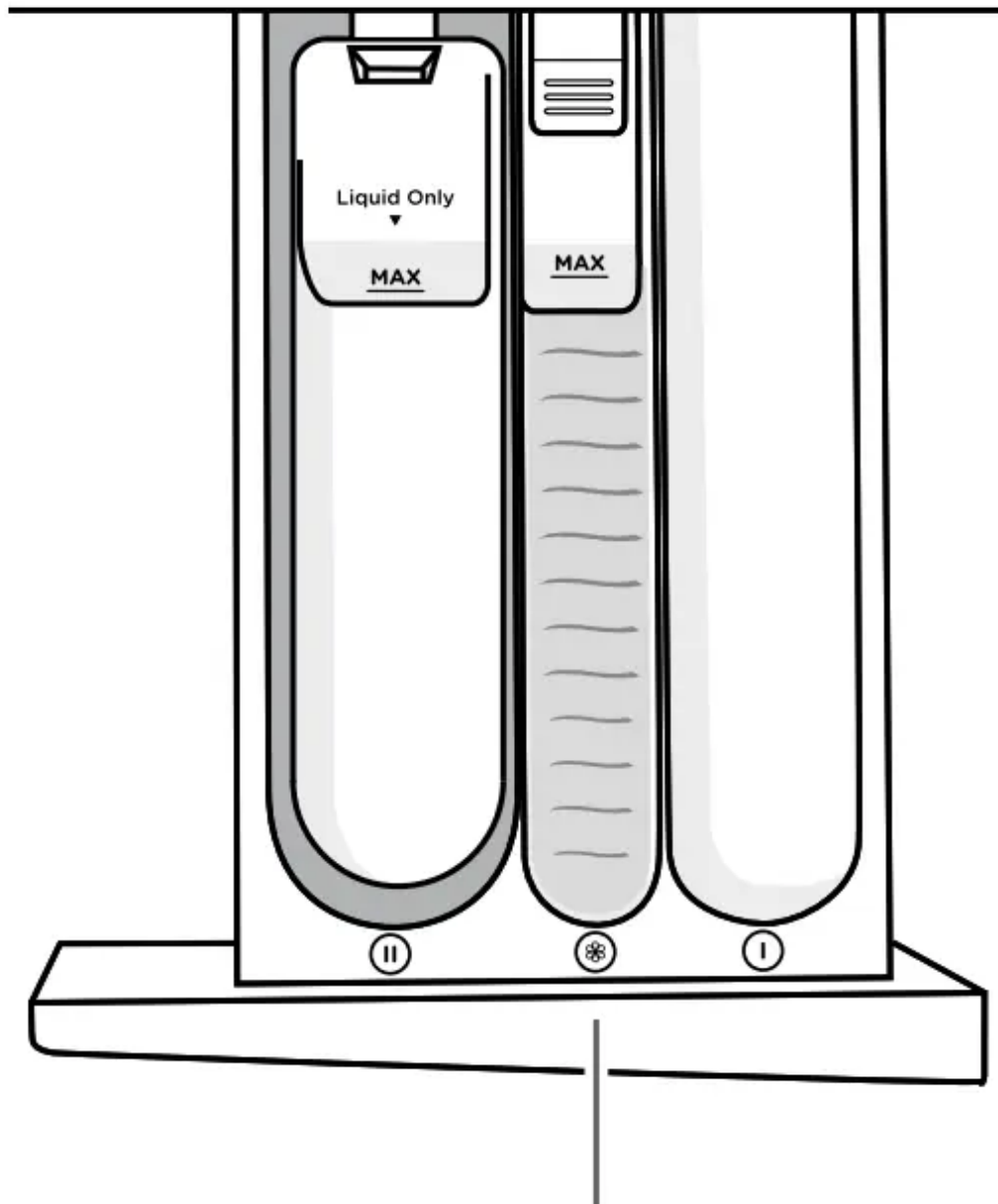

Fabric softener in compartment marked



- Sort your washing carefully. Separate white/light colours from dark colours. Wash new, highly coloured and dark coloured items separately to prevent dye transfer. Refer to the 'Sorting and loading' section.
- Load your clothes individually into the drum. Close the door.
- Use 'Top Loader/Front Loader', 'Low Suds', 'High Efficiency' or 'HE' powder, liquid or pods. Pour liquid detergent into the correct compartment in the dispenser drawer marked . If you wish to use powdered detergent you **MUST** remove the liquid detergent insert by firmly grasping and twisting the left hand side of the internal compartment and pulling

upwards. If you are using detergent pods place them at the back of the drum before adding your clothing. For more information on detergent refer to the 'Detergent and fabric softener' section.

- If you wish to use fabric softener, pour it in the compartment marked with a . For more information on fabric softener refer to the 'Detergent and fabric softener' section.

IMPORTANT! Fabric softener should not be used if you have selected the 'Quick Wash 30' cycle.

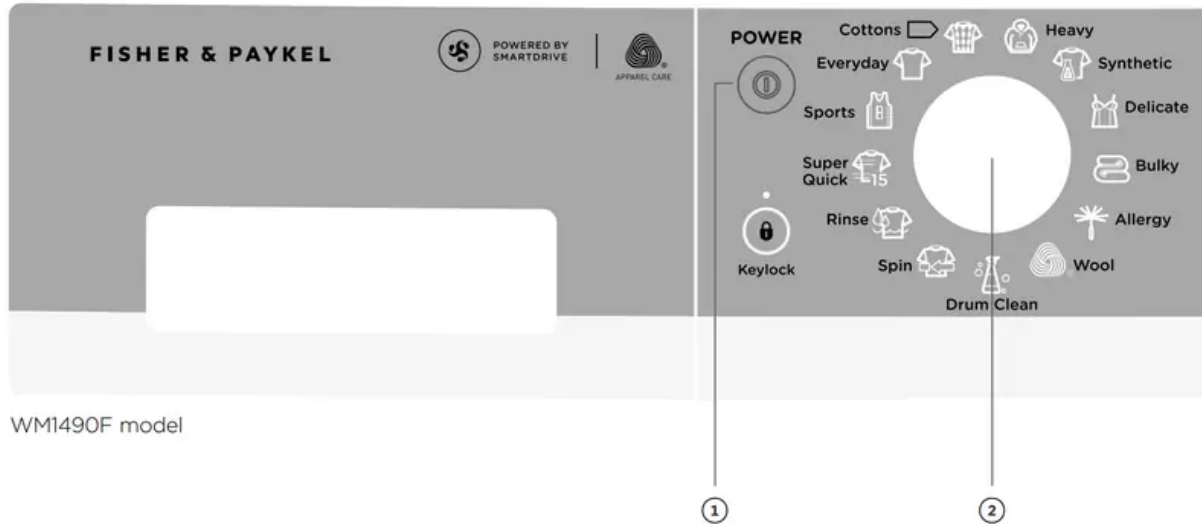

1. Press 'POWER' to activate your washer dryer.
2. Select your wash or dry cycle by turning the SmartTouch™ Control Dial.
3. Choose your wash options, if you wish to select options different from the default options for the cycle.
4. Touch to start the cycle.
 - If you make an invalid selection the washer dryer will beep to alert you.
 - When the cycle finishes, your washer dryer will perform end of cycle beeps and then turn off automatically.
 - If you wish to stop your washer at any point during a cycle simply touch to pause the cycle. There may be a slight delay while the drum comes to a stop, then the door will unlock. Under certain conditions however the door will remain locked for safety reasons (refer to the 'Safety features' section).
 - If you wish to cancel or change the wash cycle once a cycle has started, simply touch the button then select the new cycle. Touch to restart the washer.

IMPORTANT!

- For the best fabric and colour care, remove your clothes as soon as the cycle has finished.
- Failure to follow the advice in this guide may result in damage to your garments and your expectations of wash performance may not be met.

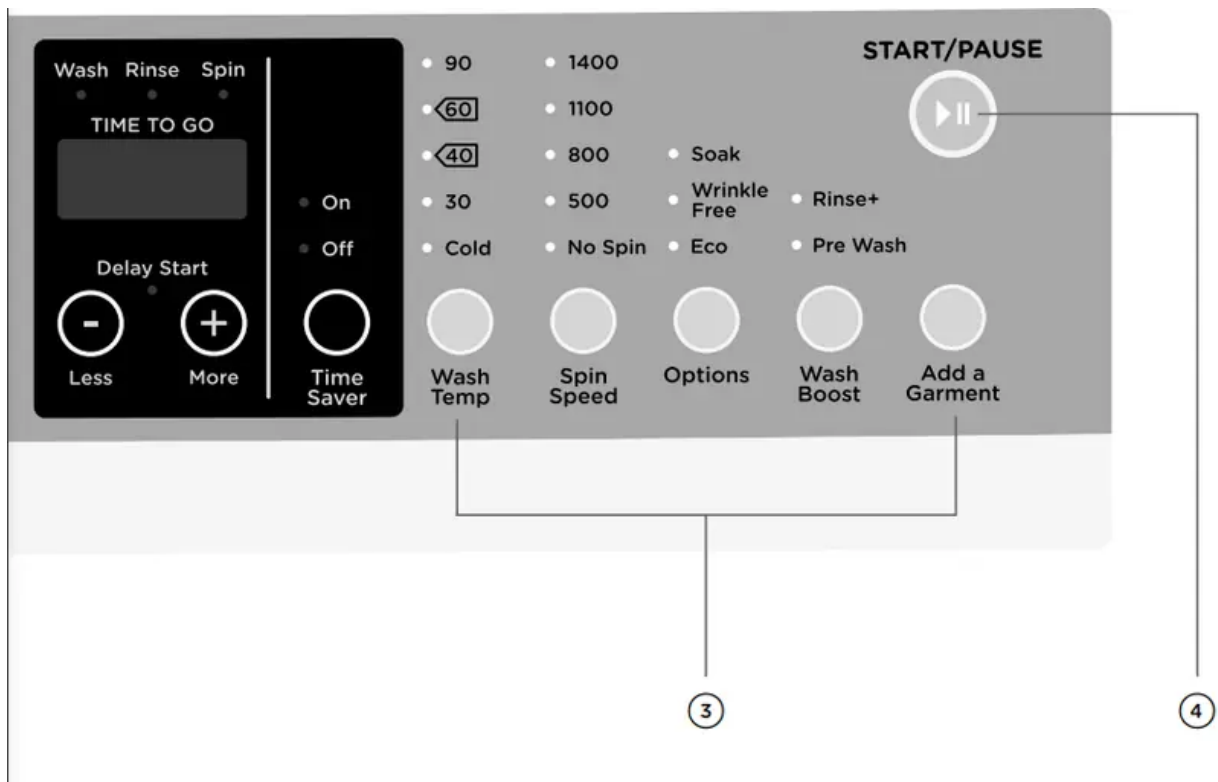

WM1490P and WM1480P models only



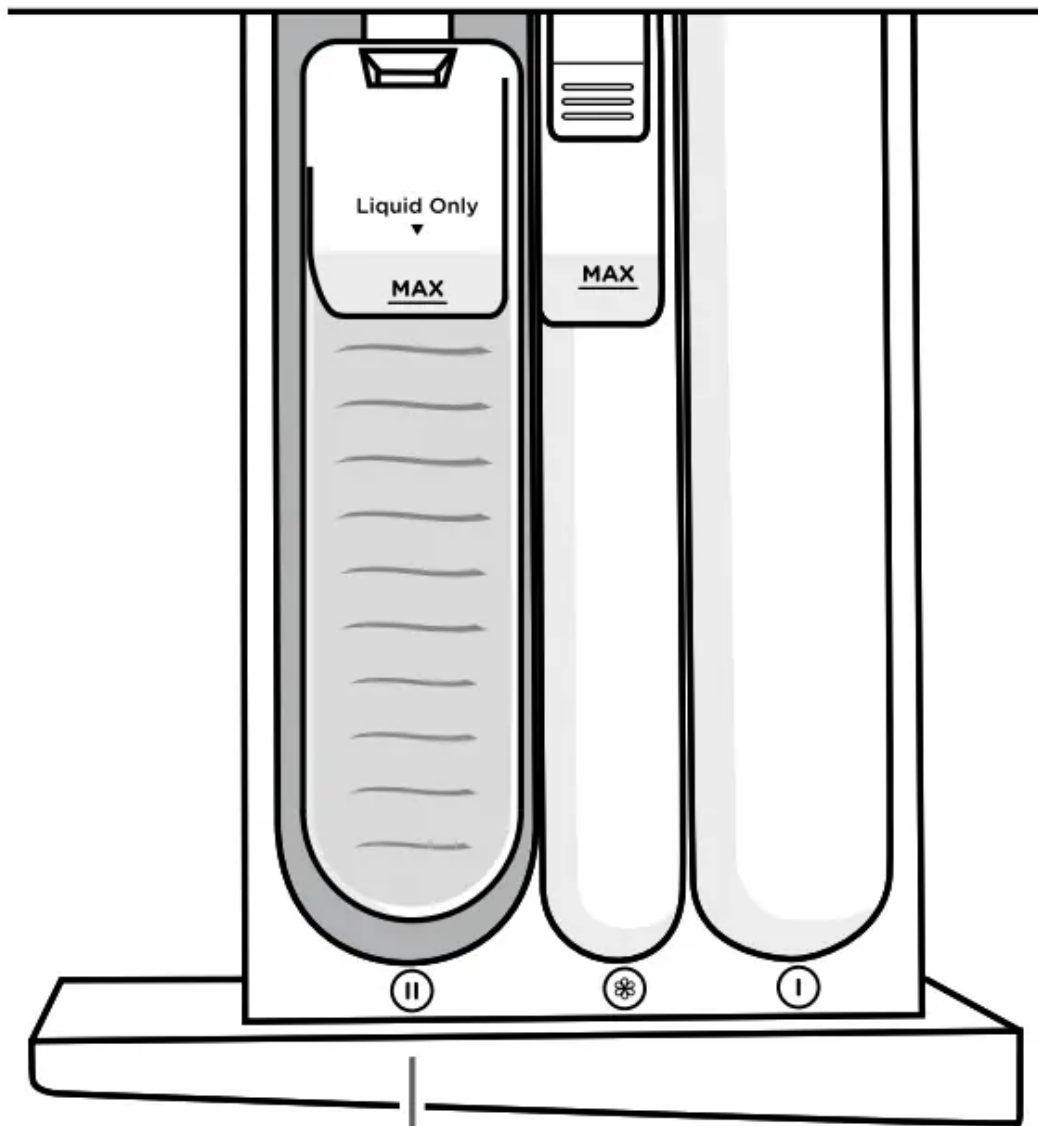

Liquid detergent in
compartment marked



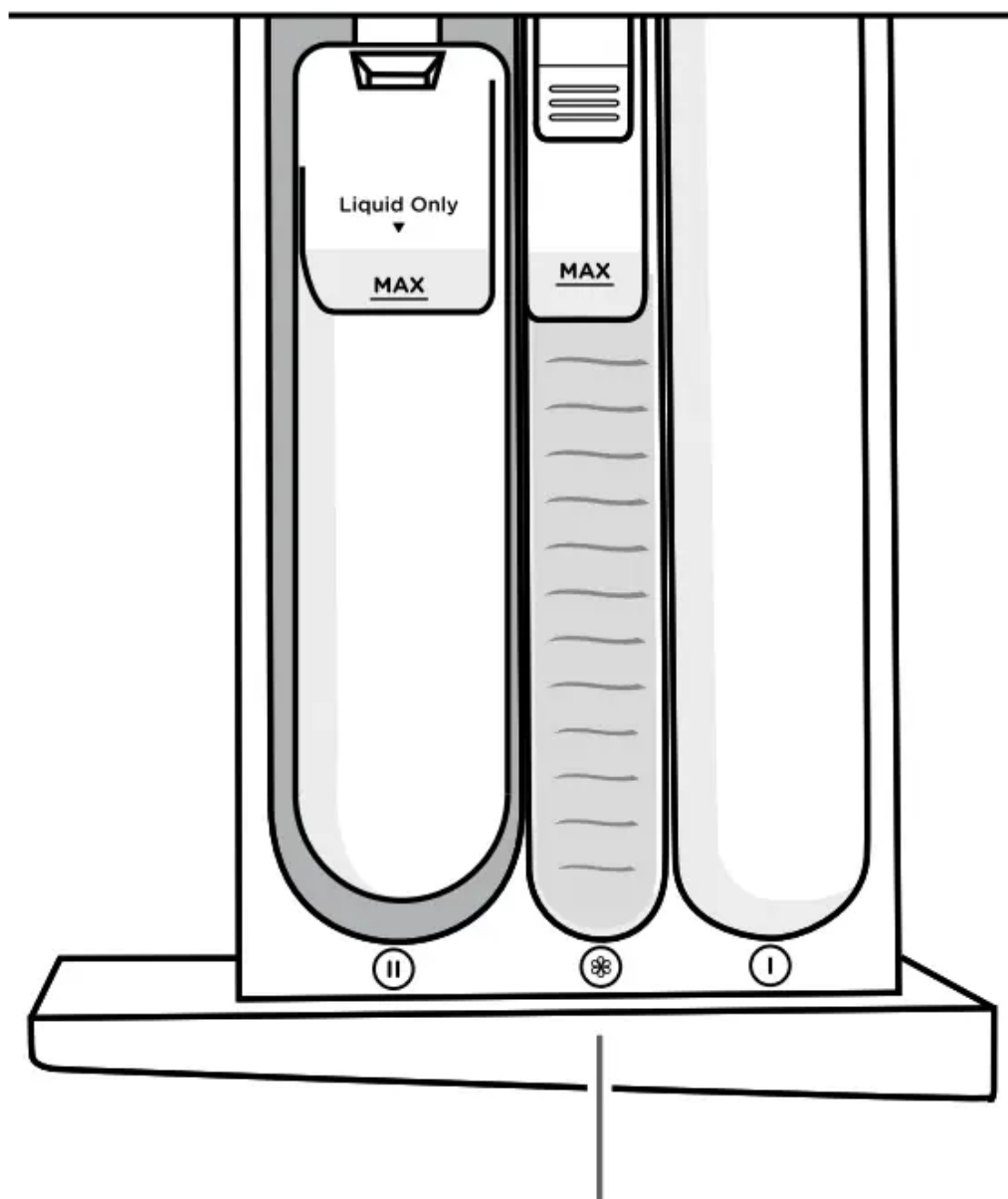

Fabric softener in compartment marked

- Sort your washing carefully. Separate white/light colours from dark colours. Wash new, highly coloured and dark coloured items separately to prevent dye transfer. Refer to the 'Sorting and loading' section.
- Load your clothes individually into the wash drum. Close the door.
- Use 'Low Sudsing' or 'Front Loader' liquid, powder or pods. Place liquid detergent into the correct compartment in the dispenser drawer marked . If you wish to use powdered detergent you MUST remove the liquid detergent insert by firmly grasping and twisting the left hand side of the internal compartment and pulling upwards. If you are using

detergent pods place them at the back of the drum before you load your clothing. For more information on detergent refer to the 'Detergent and fabric softener' section.

- If you wish to use fabric softener, place it in the compartment marked with a . For more information on fabric softener refer to the 'Detergent and fabric softener' section.

IMPORTANT! Fabric softener should not be used if you have selected the 'Quick' or 'Super Quick' cycles.

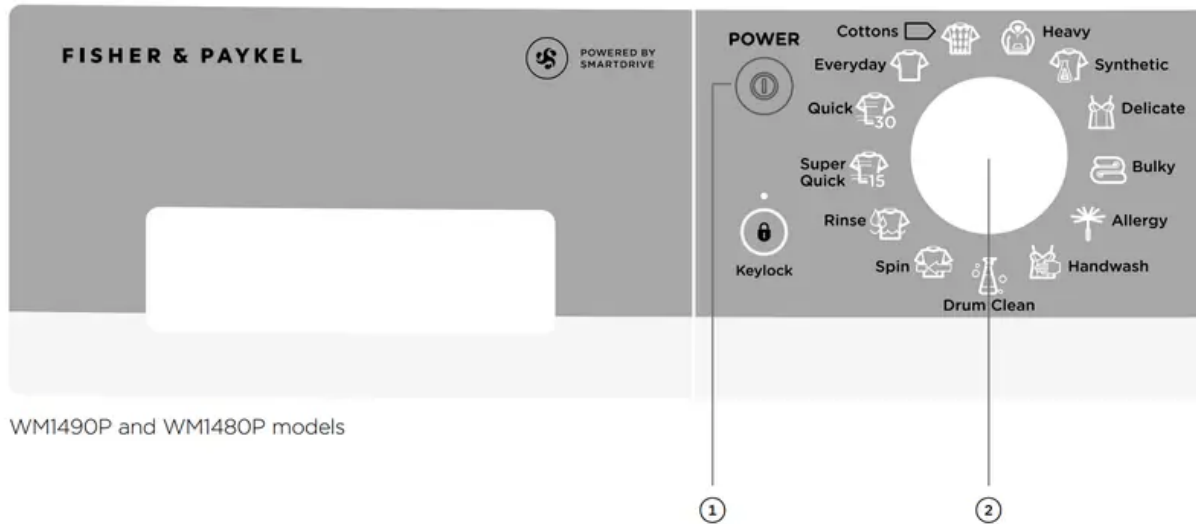

1. Press 'POWER' to activate your washer.
2. Select your wash cycle by turning the SmartTouch™ Control Dial.
3. Choose your wash options, if you wish to select options different from the default options for the cycle.
4. Touch to start the cycle.
 - If you make an invalid selection the washer will beep to alert you.
 - When the cycle finishes, your washer will perform end of cycle beeps and then turn off automatically.
 - If you wish to stop your washer at any point during a cycle simply touch to pause the cycle. There may be a slight delay while the drum comes to a stop, then the door will unlock. Under certain conditions however the door will remain locked for safety reasons (refer to the 'Safety features' section).
 - If you wish to cancel or change the wash cycle once a cycle has started, simply touch the button then select the new cycle. Touch to restart the washer.

IMPORTANT!

- For the best fabric and colour care, remove your clothes as soon as the cycle has finished.
- Failure to follow the advice in this guide may result in damage to your garments and your expectations of wash performance may not be met.

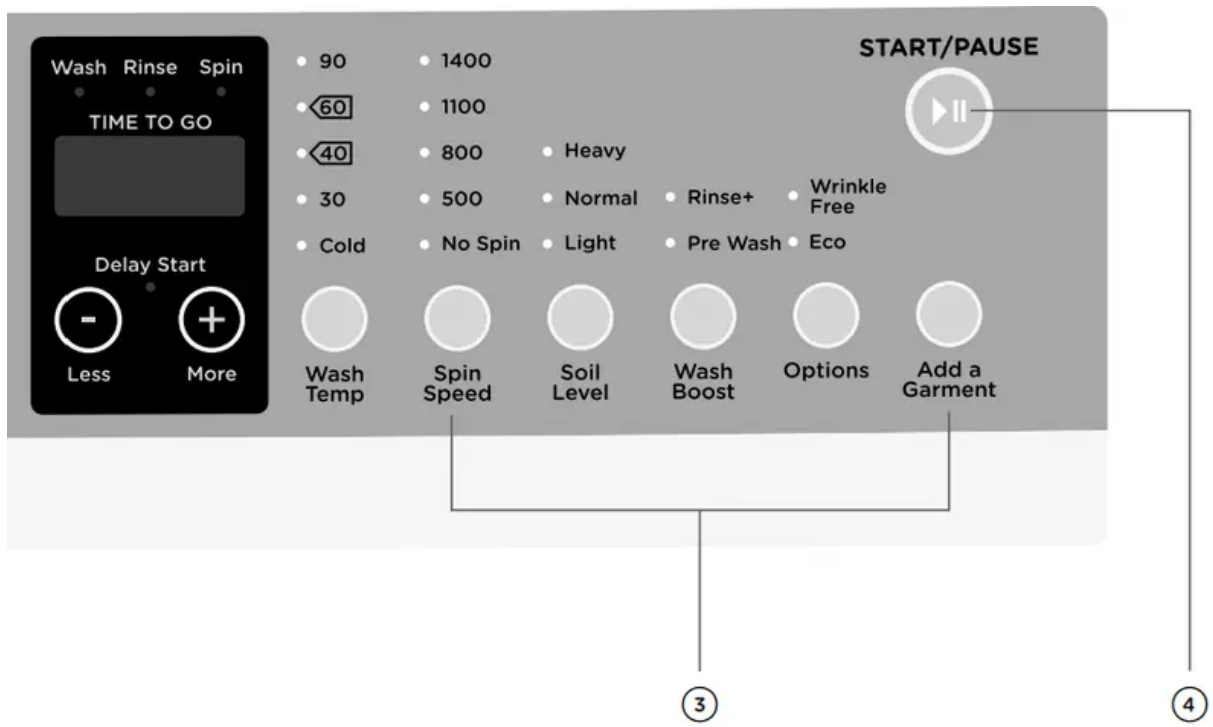

WM1280J model only



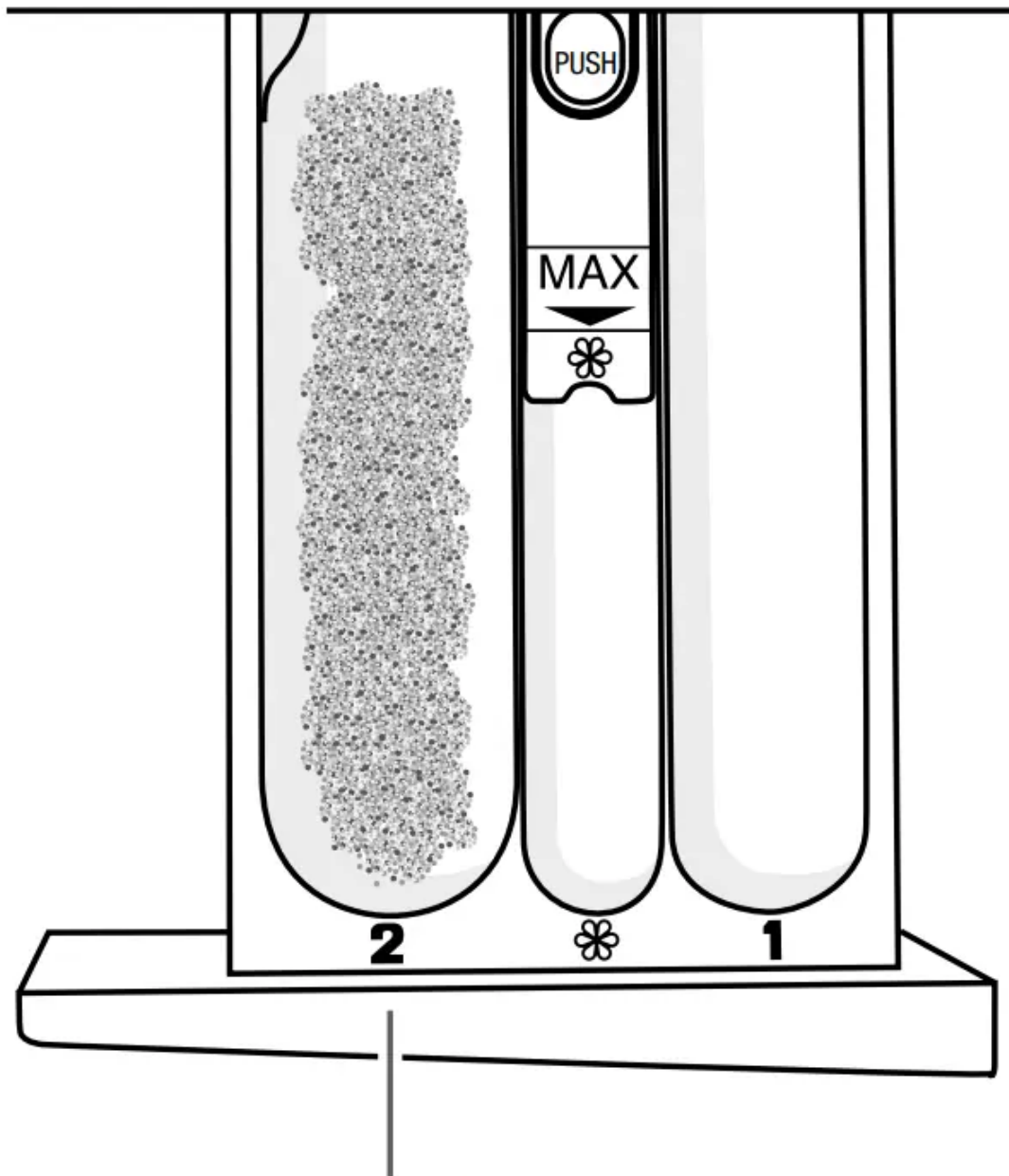

Detergent in
compartment marked **2**

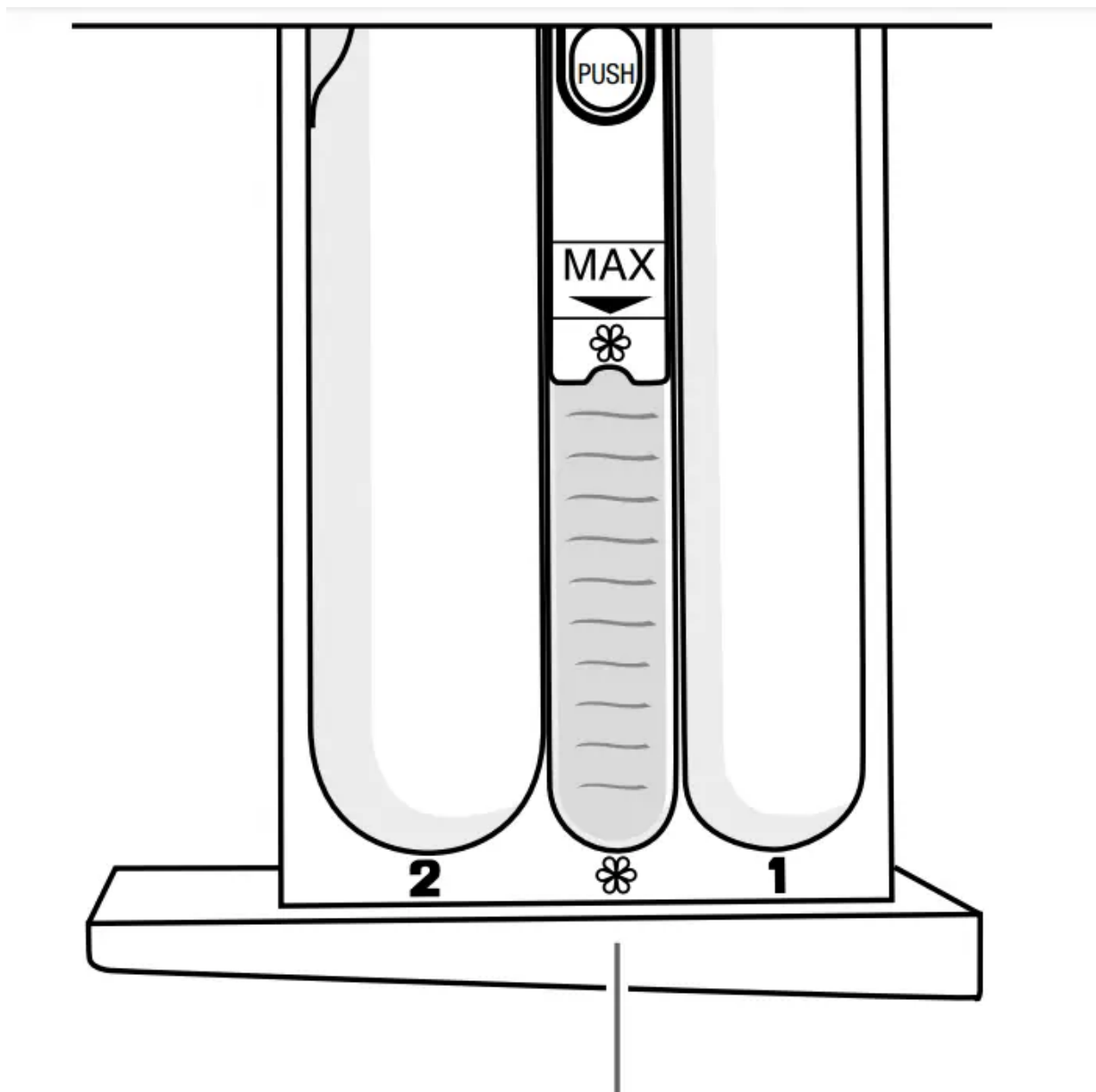

Fabric softener in compartment marked

- Sort your washing carefully. Separate white/light colours from dark colours. Wash new, highly coloured and dark coloured items separately to prevent dye transfer. Refer to the 'Sorting and loading' section.
- Load your clothes individually into the wash drum. Close the door.
- Place detergent in the correct compartment in the detergent dispenser drawer marked

2

. Use Low Sudsing or 'Front Loader' liquid or powder detergents. Alternatively use

detergent pods. Place the pod at the back of the drum before you load in any clothing. For more information on detergent refer to the 'Detergent and fabric softener' section.

•



Place fabric softener in the compartment marked with a . For more information on fabric softener refer to the 'Detergent and fabric softener' section.

IMPORTANT! Fabric softener must not be used if you have selected the 'Quick' cycle.

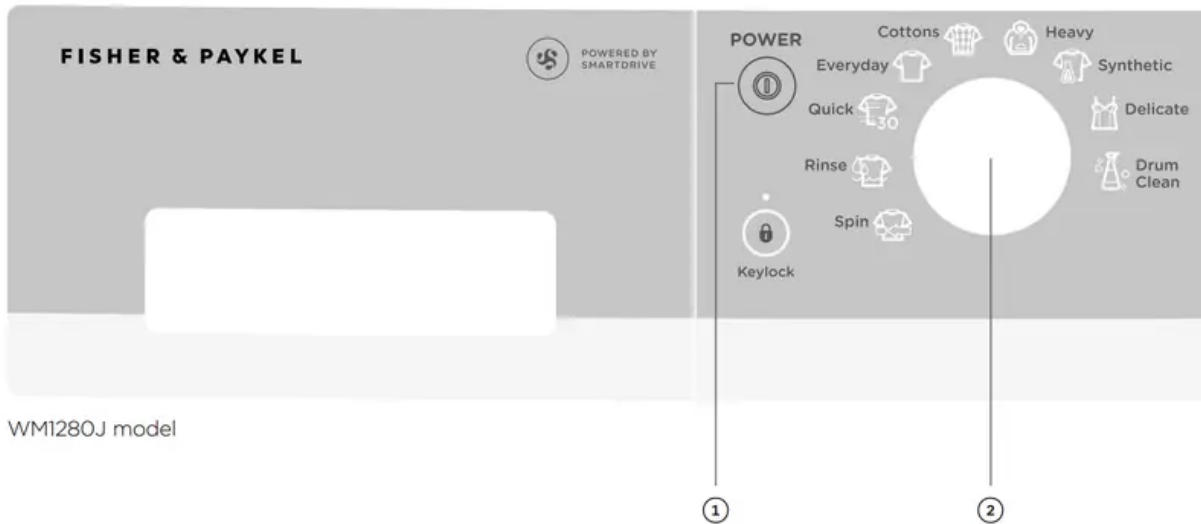

1. Press 'POWER' to activate your washer.
2. Select your wash cycle by turning the SmartTouch™ Control Dial.
3. Choose your wash options, if you wish to select options different from the default options for the cycle.
4. Touch to start the cycle.
 - If you make an invalid selection the washer will beep at you.
 - When the cycle finishes, your washer will perform end of cycle beeps to alert you and then turn off automatically.
 - If you wish to stop your washer at any point during a cycle, simply touch to pause the cycle. There may be a slight delay while the drum comes to a stop, then the door will unlock. Under certain conditions however the door will remain locked for safety reasons (refer to the 'Safety features' section).
 - If you wish to cancel or change the wash cycle once a cycle has started, simply touch the button then select the new cycle. Touch to restart the washer.

IMPORTANT!

- For the best fabric and colour care, remove your clothes as soon as the cycle has finished.

- Failure to follow the advice in this guide may result in damage to your garments and your expectations of wash performance may not be met.

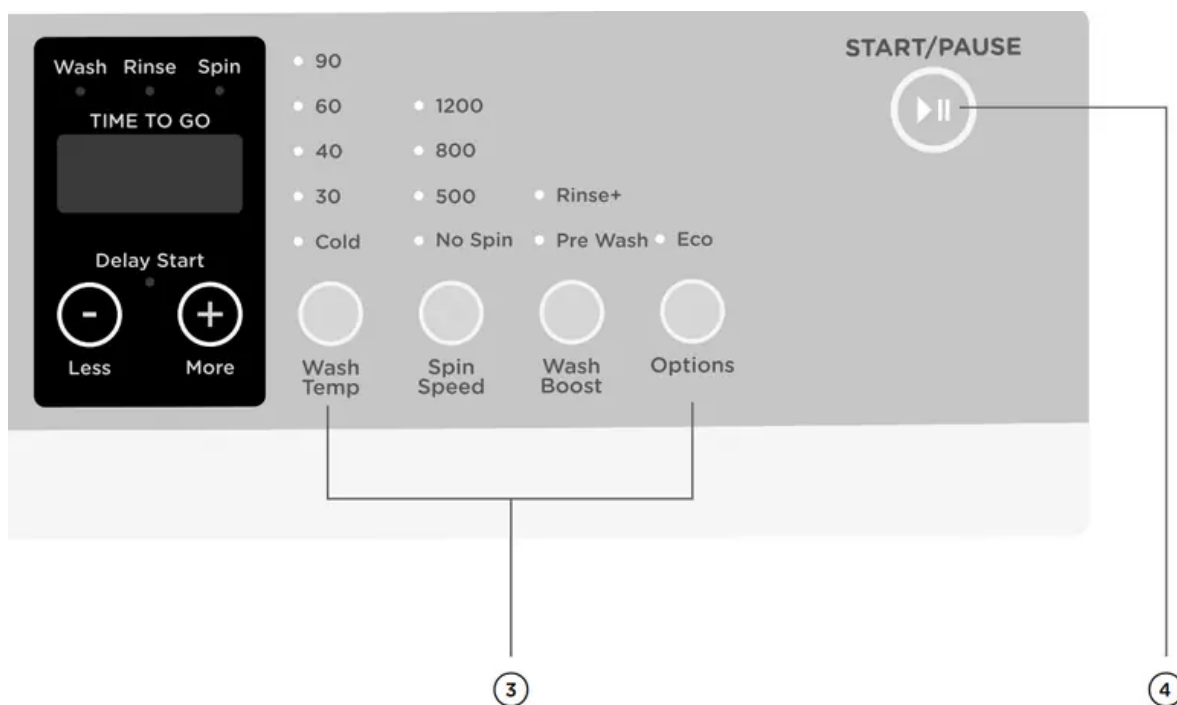

WASHER CONTROLS

- **SmartTouch™ Control Dial:** The SmartTouch™ Control Dial provides easy and efficient wash cycle selection. As you rotate the dial, the icon of the wash cycle selected will be illuminated, along with the default settings for that cycle on the right side of the control panel.
- **SmartTouch™ buttons:** The smooth, easy clean buttons enable easy selection of options with lights clearly showing the selections you are making.
- **Digital display screen:** The digital display screen provides feedback on how long the wash cycle has to go. If you have programmed a 'Delay Start', the time remaining until the cycle will start will be displayed here, along with any messages to help you with the overall running of your washer (eg user warnings).
- **Time to go**
 - Your washer displays approximately how many minutes the cycle you are running has remaining, so that you can tell at a glance when your washing will be finished.
 - Please be aware that a number of factors can influence the overall cycle time, eg the water flow rate, water pressure, whether hot water is being used from the tap or the water is heated by the internal heater, load size, cycle and option

selections. Therefore cycle times will vary. Unexpected events in a wash cycle (eg out of balance, oversudsing) can lengthen the cycle time.

- Progress lights: The progress lights indicate what part of the cycle the washer is currently on (wash, rinse or spin). All three lights are on at the beginning of the cycle. The light for the current part of the cycle flashes.
- Keylock mode: Keylock can be used to lock the buttons on your washer. This will avoid accidental button pushes. For more detail please refer to the 'Wash cycle options' section.
- Drum light (WM1490F model only): Your machine has a drum light to help assist you when loading and unloading your washing machine. When you press 'POWER', the LED light in the drum will turn on, after 2 minutes it will automatically turn off. At the end of the cycle, the drum light will turn on again for 5 minutes to help facilitate unloading.

Door lock

The door of your washer will lock once you touch until the machine beeps at the end of the cycle, ensuring safety for you and your family while your machine is operating.

To unlock the door during the cycle

- You can open the door to add or remove items during the wash simply by touching the button. Note: the door will remain locked if the temperature inside the washer is above 60°C and/or the water level is above the bottom of the door seal (a warning will be displayed in these circumstances, refer to 'Before you call for service').
- Simply touch , the machine will pause and the door will automatically unlock if the conditions inside the washer are safe. The button and time to go will flash on the screen while the washer is paused. Open the door and remove or add garments. Close the door and touch to resume the cycle.

Add a Garment (WM1490F, WM1490P, and WM1480P models only)

- The 'Add a Garment' function can be used to interrupt the cycle to add or remove a garment at any time during the wash part of the cycle (as long as the wash temperature selected is lower than 60°C). Water in the machine will be drained to a level where the door can be opened, if necessary. Refer to 'Wash cycle options' for more information.

Opening the door during a power failure

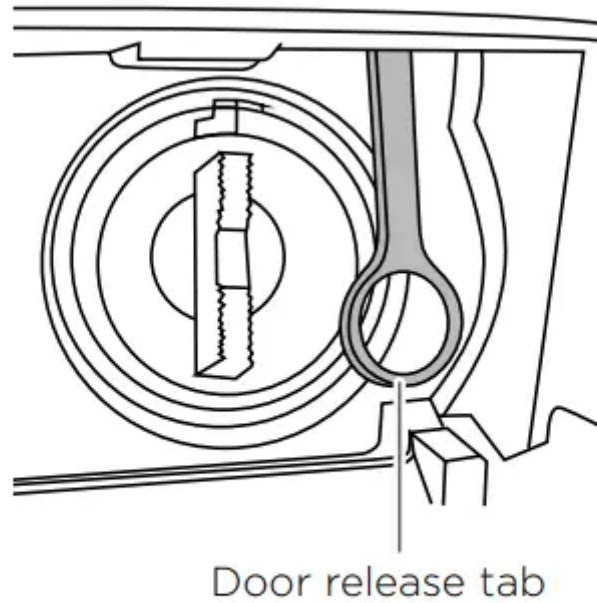

Manual door opening mechanism

- If there is a power failure during a wash cycle your washer will stop and the door will remain locked. You can unlock the washer door to remove your clothes by opening the pump filter cover at the bottom right of your washer. Simply place a coin or key in the slot and tilt it upwards to lever the cover open, then pull the door release tab.
- **IMPORTANT!** Do not attempt to do this if the water level in the washer is above the level of the door.
- When power is restored you will need to restart your machine by simply pressing 'POWER'. The washer will remember where in the cycle it was up to.
- Your washer also has the following protective measures:
 - Flood protection – turns off valves and turns pump on if a flood condition is detected.
 - Out-of-balance protection – stops and redistributes the load if an unbalanced load condition is sensed, and/or slows the spin speed to compensate.
 - Excess suds protection – pauses to allow suds to break down before continuing the cycle.

SORTING AND LOADING

When preparing your washer or dryer load there are some important things to consider:

Sorting

- Sort items according to colour, fabric type, and soil type. Wash fine, delicate fabrics separately from thick, heavy fabrics. Always separate coloured items from whites, especially when they are new. Colour run could be an issue if you wash items at higher temperatures. Some soils, like mud and blood are best washed in cold water. Oily soils (eg some foods and marks on shirt collars) are best washed in warm water. The following are recommendations for what cycles and settings you may wish to wash different items on, and suggestions for special wash requirements.

ITEMS/WASH REQUIREMENTS	SUGGESTED CYCLE AND OPTIONS*	SUGGESTED TEMPERATURE
Towels	Everyday, 1400 or 1200 rpm spin	30°C or 40°C
Sheets, pillowcases	Everyday, 1400 or 1200 rpm spin	30°C or 40°C
Bulky items - doonas, duvets, sleeping bags	Bulky	30°C or 40°C
Polycotton items	Synthetic, 1100 or 1200 rpm spin	40°C
Woollens, silks	Wool, Handwash, 500 rpm	30°C or 40°C
Delicates, fine fabrics	Delicate, Wool or Handwash	30°C
Jeans	Everyday or Heavy	Cold or 30°C
Highly coloured items	Everyday	Cold or 30°C
Whites, cotton items	Cottons, 1400 or 1200 rpm spin	40°C or 60°C
Have sensitive skin or require extra rinsing?	Allergy, Rinse+, 1400 or 1200 rpm spin	40°C
Asthma/allergies	Allergy, Rinse+	60°C
Lightly soiled items	Quick, Super Quick or TimeSaver	30°C
Muddy, sandy or linty items	Everyday, Pre Wash and Rinse+	Cold
Smelly washer	Drum Clean	90°C

* Cycles and spin speeds available will depend on your washer model.

Before you load

- Check pockets for items that could damage your clothes or get caught in the washer dryer.
- Close zippers, hooks and eyes, and other fastenings (ie fasten the opening of duvet/ doona covers), and remove loose bra wires. All these can damage both your washer and your clothes.
- Place delicate items, such as lingerie, in a mesh laundry bag before placing in the machine.
- Pre-treat any stains, taking care not to spray pre-treaters on your washer as they can cause damage to the plastic surfaces.

Loading

- Your washer will be more efficient when washing larger loads, so try to collect enough items to loosely fill the drum when the items are dry.
- IMPORTANT!
 - Do not overload your washing machine beyond its rated capacity.
 - Please do not under any circumstances wash an electric blanket in your washer unless the care label specifically states it is safe to do so.
 - Do not wash curtains in this washer, as sunlight makes them brittle and they may disintegrate during washing.

DETERGENT AND FABRIC SOFTENER

Detergent type

- Your washer requires low sudsing detergent to prevent oversudsing problems. Low sudsing detergent comes in powder, liquid or pod form and is labelled 'Front Loading', 'Low Suds', 'High Efficiency' or 'HE'.
- Using top loading detergent in your front loader washer may lead to excessive suds formation, which will lengthen the cycle time as the machine waits for the suds to dissolve

Where do I put my detergent?

WM1490F, WM1490P and WM1480P models only

- Liquid detergent: Is added to the main wash compartment on the left side of the dispenser drawer marked with a (A). As the machine fills, water is flushed into this compartment and is mixed with the detergent, the detergent solution is then delivered into the drum. There may be a small volume of water left in the liquid detergent dispenser at the end of the cycle. This is normal.
- Powdered detergent: If you wish to use powdered detergent, the liquid detergent compartment MUST be removed from the dispenser drawer. To do this firmly grasp and twist the left hand side of the internal compartment and pull upwards (B). To replace the liquid detergent compartment slide it back into the drawer marked (C). Press down in the middle until it clicks (D).

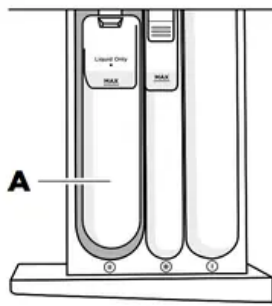

Detergent dispenser drawer

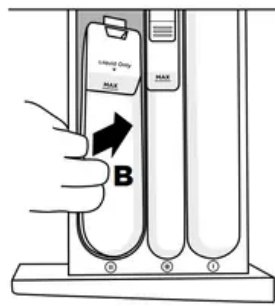

Removing the liquid detergent compartment

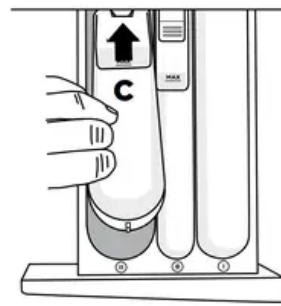

Replacing the liquid detergent compartment

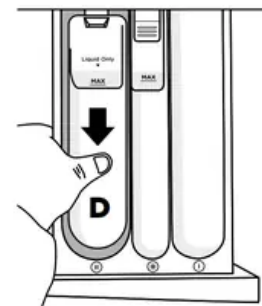

Clicking in the liquid detergent compartment

IMPORTANT!

- If using liquid detergent ensure the liquid detergent compartment is installed.
- If using powder ensure the liquid detergent compartment has been removed.
- Make sure the detergent drawer is completely closed before starting the cycle.

WM1280J model only

- Powdered or liquid detergent: Is added to the main wash detergent compartment on the

2

left side of the dispensing drawer marked with a . As the machine fills, water is flushed through this compartment to deliver a detergent solution into the drum.

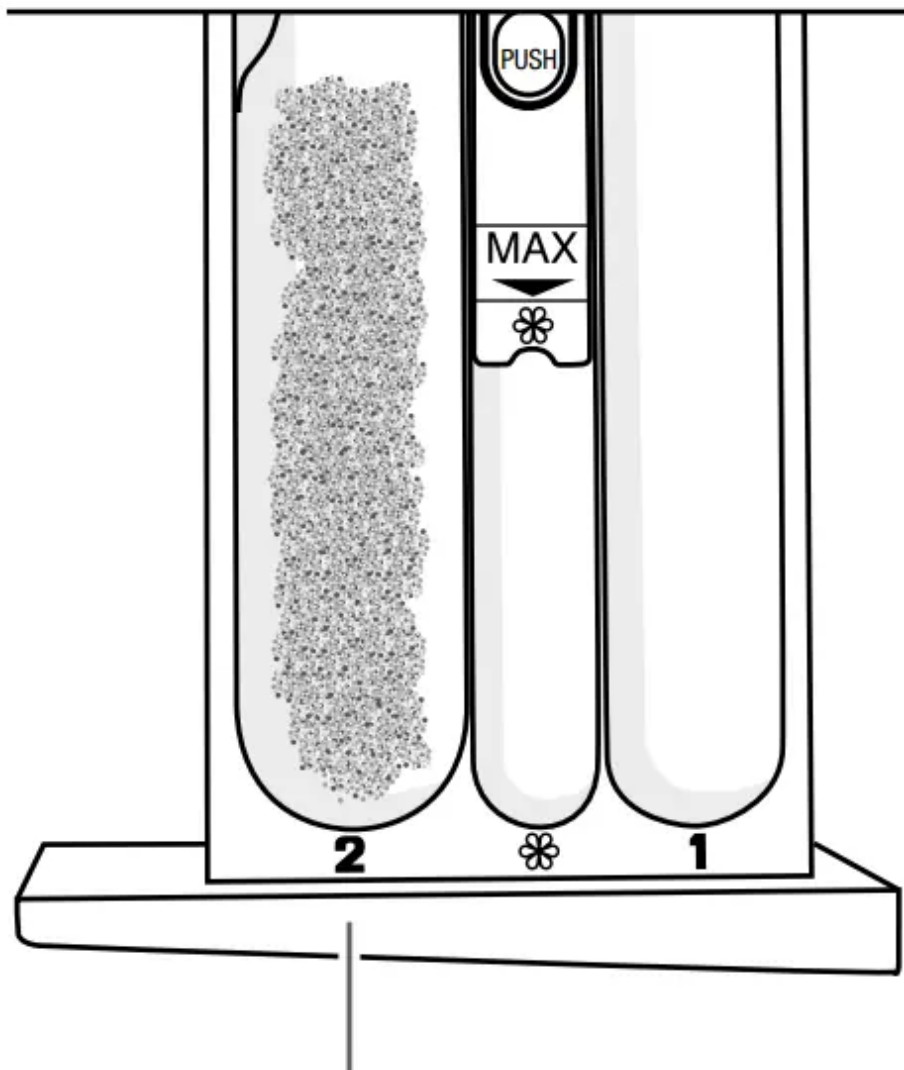

Detergent in the detergent compartment marked **2**

IMPORTANT!

Make sure the detergent drawer is completely closed before starting the cycle.

If you select the 'Pre Wash' option, you must use a powdered detergent in the main wash detergent compartment.

Pods

- Detergent pods are a 'no mess' alternative to powdered or liquid detergent. They must be placed at the back of the drum prior to loading your clothes. This will ensure they are activated quickly in the wash. Do not place pods in the detergent dispenser drawer or on top of your clothes.

Pre Wash

- If you wish to use the 'Pre Wash' option, liquid or powdered detergent only must be placed in the pre wash detergent compartment on the right side of the drawer, marked

with either a  or **1**. When you select 'Pre Wash', the pre wash compartment is flushed at the start of the cycle. For more information refer to 'Wash cycle options'.

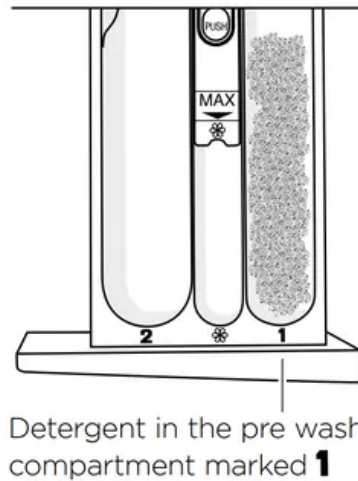
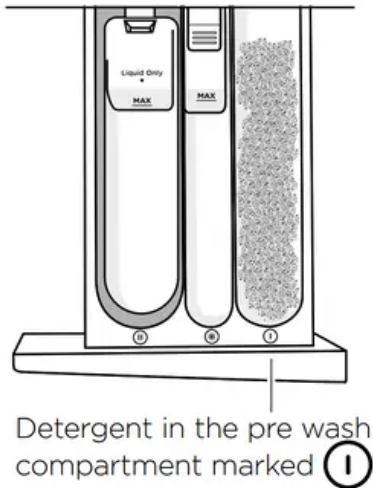

'Pre Wash' option

IMPORTANT!

- Make sure the detergent dispenser drawer is completely closed before starting the cycle.
- WM1280J model: If using 'Delay Start' we recommend you use powdered detergent for the main wash.

How much detergent?

- The correct detergent dosage varies depending on the amount of soil in your load, the size of the load and the water quality, so getting the correct dose takes some trial and error. Use the instructions stated on the detergent package as a guide, then alter the dosage according to the results.
- If you overdose, you will get over foaming issues, but if you under-dose you will get poor performance and over time your washer will start to smell as scum builds up inside it.

Detergent advice

1. If your washer smells you are probably not using enough detergent for the soil level in your loads. Run a 'Drum Clean' cycle and either buy a better quality detergent or use a higher dose. If you are using an 'Eco' detergent, alternate the use of this with a mainstream detergent.
2. Add the detergent BEFORE starting the cycle, close the dispenser and do not open it while the cycle is running.

3. If you find foam leaking from your washer, check you are using a low sudsing or front loader type detergent and check the quantity you are using against the detergent manufacturers recommendation. You may need to reduce the amount you are using.

Fabric softener



Add fabric softener to the middle compartment of the dispenser marked with a or a . The washer will automatically flush the fabric softener during the rinse part of the cycle. If you wish to use fabric softener we recommend to:

1. Use it sparingly. Measure it carefully and do not use more than 25mls (1/2 cap), some thicker varieties may need diluting.
2. Clean your dispenser regularly.
3. Clean your machine regularly using the 'Drum Clean' cycle.
4. Complete wash cycles at a wash temperature of 40°C or above at regular intervals (eg every 5th wash) as washing in cold water increases the chance of scrud occurring (see below).

Note: if you fill beyond the MAX mark, the fabric softener will be dispensed into the bowl prematurely and contribute to scrud.

Scrud

- Scrud is the name of the waxy build-up that can occur within any washer when fabric softener comes in contact with detergent. This build-up is not brought about by a fault in the machine.
- If scrud is allowed to build up in the machine it can result in stains on clothes and an unpleasant smell in your washer. If you wash a particularly dirty load, we recommend putting the washer through a 'Rinse' cycle once the cycle has finished and the load has been removed, to clean out any remnants from that cycle.

CARING FOR YOUR WASHER DRYER

When you have finished using your washer dryer

- Unplug the machine from the power socket.
- Wipe around the door and in the rubber gasket to remove any remaining water/condensation, lint and foreign matter.
- Turn off the taps to prevent the chance of flooding should a hose burst.

Cleaning your washer

- Before you start cleaning your washer, ensure that it is disconnected from the power (ie unplug the machine from the power socket).

Cleaning the control panel and outer surfaces of the washer dryer

- Use a soft damp cloth to wipe all surfaces, then wipe dry. Avoid using chemical or scouring cleaners, as these will damage the paint and plastic surfaces of your washer dryer.

Cleaning the detergent dispenser drawer

- Wipe out the detergent dispenser drawer with a damp cloth. Clean it regularly, especially if you use fabric softener. To remove the drawer, pull it open, push down on the tab in the fabric softener compartment and pull out. Rinse it out under warm water and replace.

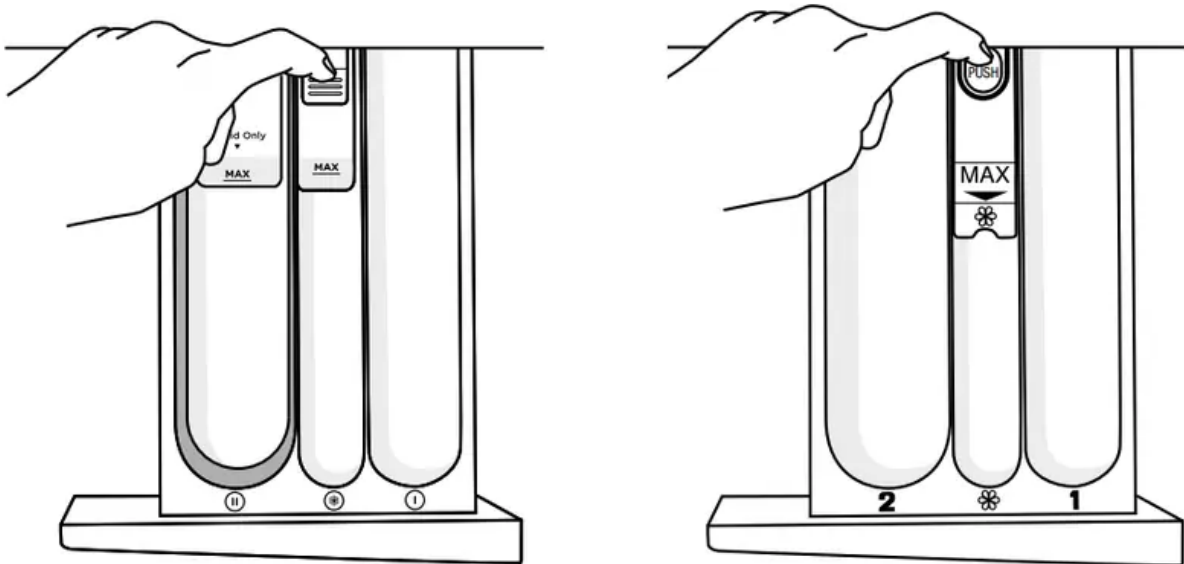

Removing the dispenser drawer for cleaning

Cleaning the inside of your washer dryer

- It is important that you regularly clean the inside of your machine using the 'Drum Clean' cycle. After 100 cycles the icon will flash every time you turn your washer dryer on to remind you to do this. If your washer dryer starts to smell this is a sign that you should complete a 'Drum Clean' cycle. We recommend that you do not have any items in the washer dryer when you run this cycle.

Cleaning steps

1. Add approximately 2 full scoops of a good quality powdered detergent directly into the

2

main wash detergent compartment of the dispenser drawer (marked or) or use a drum cleaning product specifically designed for front loading washing machines (follow manufacturer's instructions).

2. Press 'POWER' to turn your machine on and select the 'Drum Clean' cycle.
3. Touch to start the cycle (refer to the 'Wash and dry cycles' section).

Cleaning the drum and the door

- Use a soft damp cloth to wipe the door, cleaning any water marks or residue off it.
- Wipe the rubber seal around the door. Remove any items or lint accumulating in the bottom of the seal catchment and wipe out any water accumulated here. If this is not cleaned out, unpleasant odours will develop.
- If the drum has any residual dirt or lint stuck to it, remove this and wipe the drum clean. Do not leave any metal objects in the drum as these may rust and cause staining.
- The WM1490F model also has a self cleaning door flush that directs a portion of the rinse water over the door during various stages of the cycle to help to clean hair and insolubles from the inside of the door and surrounding parts. We still recommend that you manually clean it with a soft cloth periodically as per the instructions above.

Cleaning the pump filter

The pump has a filter to trap foreign objects that enter the washer dryer along with clothing. The pump filter can be accessed from the front of the washer dryer.

To clean the filter: This should be cleaned out approximately once a month.

1. Turn the power off and unplug the machine.
2. Use a coin to open the filter cover. Place the edge of the coin into the slot and tilt upwards whilst levering the cover open.
3. Unhook the pump outlet hose and pull it out (about 150mm). Remove the plug and allow any water (approximately 250ml) to drain into a shallow dish.
4. After the draining process is complete, replace the plug into the hose and refit the hose back into the housing.
5. Remove the filter by turning anti-clockwise. Clean and rinse under a tap. Check the pump filter cavity for any further obstruction.

6. Replace the filter by turning clockwise until the white mark on the filter is in line with the white line on the pump housing

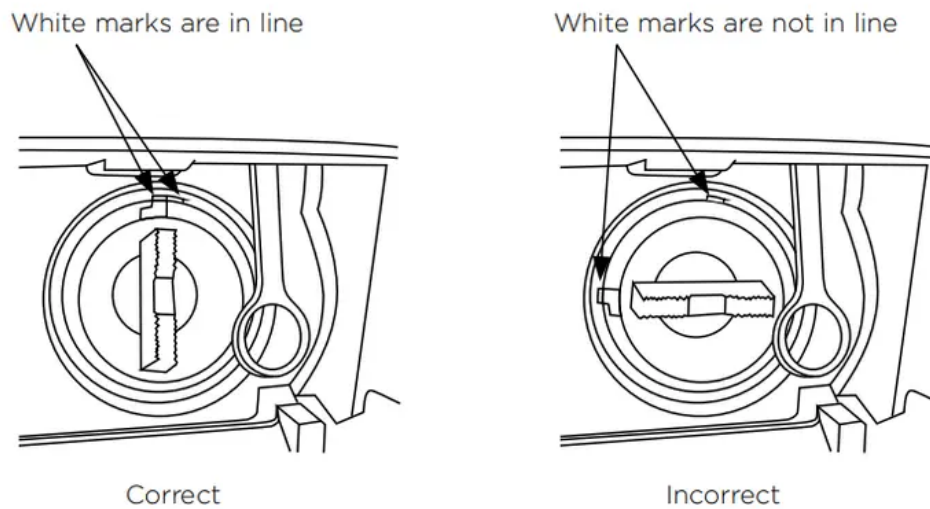

White mark on filter must be in line with white line on pump housing

7. Close the filter cover.

White mark on filter must be in line with white line on pump housing

Cleaning the hose

- The hose has a filter in it, preventing any solid contaminants in the water entering your washer dryer. Occasionally you should disconnect the water inlet hose where it connects to the taps, check for any build up of dirt and wash this out.

Nappy sanitisers/bleach

- Nappy sanitisers and bleach are very corrosive to metal surfaces. DO NOT tip the contents of a nappy bucket into your machine. Rinse and wring items out thoroughly before placing them in the machine.

Moving your washer dryer

- If you need to move your washer dryer a considerable distance (eg moving house), remember to replace the transit bolts before moving it. These will protect internal components of the washer dryer from damage.
- To replace the transit bolts, pull out the bolt-hole covers at the back of the machine. Push the transit bolt rubber grommets and plastic spacers into the hole left and tighten it with the spanner provided with the product.
- Make sure any water in the washer dryer is drained out. This can be done by cleaning out the pump filter (refer to 'Caring for your washer dryer' section 'Cleaning the pump filter').

IMPORTANT!

- Leave the door to your washer dryer open when it is not in use to allow the washer dryer to dry out, otherwise it will develop unpleasant odours. When leaving the door open like this, it is extremely important that children and pets are kept away from the washer dryer so they cannot be accidentally trapped inside it.
- Aside from the detergent dispenser, water hose, and the pump filter, no other parts are designed to be removed from the machine for cleaning. Do not attempt to remove any other part of the machine.

Troubleshooting

User warnings

- Your washer dryer is capable of diagnosing a number of its own problems. It will sound a continuous series of beeps and display a code when it has a problem that you can correct yourself. All control panel lights will turn off and the code will be displayed to inform you what the problem is. To stop the beeps, press any button on the control panel. Do not try to continue washing or drying once you stop the noise. You must address the problem the washer dryer is alerting you to.
- Check this chart before you call for service.

PROBLEM	DISPLAYED AS	WHAT TO DO
Keylock is activated.	KEY LOC	Touch and hold the 'Keylock' button for 2 seconds.
Pump filter is blocked.	CLr FLtr	Clear the pump filter (refer to page 37).
Water is not getting to the machine	no TAP	<p>Check the tap has been turned on.</p> <p>Check the hose connection.</p> <p>Check the inlet hose filter is not blocked, the hose is not kinked and is attached correctly.</p> <p>Check that the drain hose is not too low or pushed into the standpipe too far. This will cause the water to siphon out of the machine.</p> <p>Check the cold water temperature does not exceed the 35°C temperature requirement.</p> <p>Check the water flow rate. It maybe too low.</p>
Wash load is out of balance.		<p>Touch to try the spin again.</p> <p>If the out of balance persists, pause the cycle, manually redistribute the load and touch to spin again. If necessary, stop the cycle, select 'Spin' and touch .</p> <p>If the problem persists, check the machine is correctly levelled.</p>

Too many suds.		<p>Machine will stop and flash while waiting for suds to dissipate. The machine will not beep during this time. When the suds have dissipated, the machine will automatically restart. If a suds event has occurred during a cycle the machine will also display this warning at the end of the cycle, to alert you that this has occurred. This may help to explain any reduction in performance.</p> <p>Check you are using a suitable detergent.</p> <p>Check you are not overdosing the detergent.</p> <p>Check the standpipe height for the drain does not exceed 1200mm.</p>
Machine is too hot.		<p>The temperature in the drum is over 60°C therefore it is not safe to open the door. Wait until the temperature drops below 60°C then the machine will open the door.</p>
Door is locked.		<p>The temperature in the drum is over 60°C therefore it is not safe to open the door. Wait until the temperature drops below 60°C.</p> <p>Check the water level in the drum. If the level is above the bottom of the door seal, the door cannot be opened. Use the 'Add a Garment' button if you wish to add or remove items (WM1490F, WM1490P and WM1480P models only).</p> <p>If the drum is still moving, wait for it to stop before attempting to open the door.</p>
Door is open.		<p>Close the door fully and touch .</p> <p>Try opening and closing the door again.</p> <p>Reposition the load, make sure the load is correctly in the drum and that protruding items are not stopping the door from closing.</p>

FAULT CODES

When a continuous series of beeps is sounded, all the lights turn off on the control panel and a number appears on the display, a fault has occurred. The washer dryer will automatically enter this mode if a fault occurs. The fault code will be displayed as followed by a number on the digital display. To stop the sound, touch any button and perform the following steps:

1. Turn your machine off at the power point.
2. Wait one minute and turn it back on.

3. Check your machine is correctly levelled.
4. Remove your load.
5. Perform a 'Rinse' cycle.
6. If the fault re-occurs repeat steps 1 and 2.
7. If the machine still will not work you will be required to call a Fisher & Paykel trained and supported service technician to arrange service (refer to the 'Customer Care' section). Record the fault code number displayed and the serial number of your washer dryer (located on the rear of the machine, and/or above the drum opening when the door is open) before calling. The fault code will indicate to the Fisher & Paykel trained and supported service technician what the problem could potentially be.

If a fault code is being displayed, you can still turn your washer dryer off by pressing 'POWER'.

The following is a list of problems you may encounter when using this appliance and some suggestions that may help to correct the problem. If you still have problems, please contact your Fisher & Paykel trained and supported service technician.

Solving general operating problems

PROBLEM	POSSIBLE CAUSES	WHAT TO DO
Washer not turning on.	Power not switched on at the wall.	Switch the power on at the wall. Then press 'POWER'
	Household power supply not working.	Try plugging in another electrical appliance.
	Keylock may be activated	Touch and hold the 'Keylock' button for 2 seconds
Touching does not start filling or drying.	Washer dryer door not closed properly	Open and reclose door.
	The washer is waiting for a command from you.	If is flashing then the washer is waiting for a command from you.
	The washer has detected a fault	Check if a code is being displayed on the panel
	Hot and cold taps not turned on.	Check that both hot and cold taps are turned on (if using cold inlet only ensure inlet valve cap is installed on the hot valve on the machine)
	Hot and cold taps not connected to the corresponding valve on the machine.	Check the cold tap is connected to the cold valve on the machine and the hot tap is connected to the hot valve.
	Blocked hose filters.	Check the tap end of the inlet hoses for blockages.
	Inlet hose leaking, twisted or damaged.	Check the inlet hose for leaks or damage. Check that the inlet hose is not twisted.
	Faulty water supply.	Check taps that aren't connected to the machine are working.
	Delay start maybe set.	Refer to page 34.
Washer dryer stops working mid cycle.	The washer dryer has detected a fault.	Refer to pages 39 – 41.

	Power or water failure.	Check the power and/or water is working correctly.
	Washer dryer has been paused.	Touch the button to continue.
	Too many suds.	Washer dryer is waiting for suds to dissolve before continuing the cycle.
Washer drains while filling.	Drain hose too low.	Ensure the height of the drain hose is at least 800mm from the floor level (refer to page 10).
	Drain hose sitting in water	Clear the drain
Washer is not draining.	Drain hose blocked.	Clear the drain hose.
	Pump filter blocked.	Clear the pump filter (refer to page 37).
	Drain hose higher than 1200 mm above floor level.	Lower the level of the drain hose (refer to page 10).
Filling continuously	Drain hose not connected to standpipe or tub.	Connect drain hose correctly (refer to page 10).
	Machine siphoning.	Ensure standpipe or tub is at least 800mm from the floor level.
Poor rinsing.	Incorrect detergent used.	Use low sudsing, front loader detergent only (refer to page 24)
	Too much detergent used.	Ensure the correct dose of detergent is used for the load size and soil level (refer to page 26).
Not spinning properly	Load has gone out of balance.	Open door and redistribute load, then restart the washer dryer.
	Machine is not level.	Ensure machine is correctly levelled
	Suds build up	Check the amount of detergent used, reduce if necessary

Too many soap suds.	Incorrect type of detergent used.	Use low sudsing, front loader detergent only (refer to page 24).
	Too much detergent used.	Ensure the correct dose of detergent is used for the load size and soil level (refer to page 26).
Small puddle of water from under the machine.	Inlet hose or drain hose leaking.	Check inlet hoses and the drain hose are correctly attached and not damaged.
	Lots of suds.	Suds may have leaked and then dissolved.
	Detergent dispenser blocked.	Clean detergent dispenser drawer (refer to page 36).
	Detergent dispenser drawer not fully closed.	Close detergent dispenser drawer fully and ensure it remains closed during the cycle.
	Damage to door seal.	Check seal inside door for damage. If it sustains any damage it will need to be replaced.
Cycle time longer than usual/Inaccurate time reading/ Adjustment of time remaining during cycle.	Wash time is approximate.	Wash time may be influenced by a number of factors (refer to page 20)
	Low water pressure or flow rate.	Ensure that the inlet hose filter is not blocked.
	Out of balance or oversudsing.	Recovery from out of balance or oversudsing will extend cycle time (refer to page 39).
	Washing a large load	Be aware that it will take longer for the machine to fill.
	Selecting various options	Be aware that some options will extend cycle time.
Detergent or fabric softener remaining in detergent dispenser at the end of the cycle.	Detergent drawer not properly closed or was opened part way through the cycle.	Ensure the detergent dispenser drawer is fully closed at the start of the cycle and remains closed throughout the cycle.
	Dirty or blocked detergent dispenser.	Clean the detergent dispenser (refer to page 36).

	Liquid sitting at the 'Max' level at the end of the cycle indicates a blockage.	Clean the fabric softener dispenser (refer to page 36).
	Dispenser over loaded with detergent.	Clean out remaining detergent and refer to page 26 for dosing information.
Washing very wet at the end of the cycle.	Cycle selected not appropriate.	Particularly short or delicate cycles have shorter spins which can result in wetter washing at the end of the cycle.
	Incorrect spin speed for load selected.	Select a faster spin speed
	An out of balance load has occurred.	The washer compensates for the out of balance by using a lower spin speed, to reduce noise and potential damage to itself.
Vibrating.	Transit bolts left in place.	Ensure transit bolts are removed prior to use of the machine (refer to page 6).
	Washer may not be level.	Ensure washer is installed on an appropriate surface and levelled correctly (refer to page 8).
	Load is out of balance.	Wash an average sized load rather than a smaller load or a single item. Washing one item at a time is not recommended as it is difficult for the washer to balance a single item during spin.
Creasing	Washer overloaded.	Do not overload washer
	Incorrect cycle for load type	Use the 'Easy Iron' or 'Handwash' cycle for creasable items
	Spin speed too fast.	Select a slower spin speed.
	Wet clothes left in washer or laundry basket	Laundry left sitting wet is more likely to crease. If not removing clothes from washer immediately at end of cycle, select the 'Wrinkle Free' option (WM1490F, WM1490P)

		and WH1480P models only). Do not leave wet washing sitting in a washing basket
	Wash temperature too hot for load type.	Select a lower wash temperature. Check items care label for correct care.
	Items not sorted correctly	Sort load so that items of similar weight are washed together (refer to page 22)
Poor soil Removal.	Incorrect wash cycle selected.	Select a wash cycle that is appropriate for the amount of dirt
	Insufficient detergent.	Ensure the correct dose of detergent is used for the load size and soil level
	Washer overloaded.	Ensure the washer dryer is not overloaded in terms of its capacity or the cycle selected
	Items require a longer wash time.	Select a higher soil level option if available (WM1490P and WM1480P models only).
	Load was particularly dirty.	Select 'Pre Wash' for particularly dirty loads
	Items not sorted correctly	Wash heavily and lightly soiled garments separately.
	Washer dryer dirty from previous wash or dry cycle.	After washing particularly dirty clothing, we recommend putting the washer dryer through a 'Rinse' cycle after the load has been removed, to wash away any remnants of dirt and to prevent it contaminating future wash or dry cycles
	Incorrect wash temperature selected in relation to the type of soil.	Select a wash temperature suitable for the type of soil, eg warm for greasy soils, cold for muddy soils. Increasing the wash temperature generally improves soil removal and overall wash performance
Dye transfer.	Coloured items not washed separately from white/light coloured items.	Remember to separate whites and colours.

	New or non-colourfast items not washed separately	Wash non-colourfast items separately and select 'Cold' wash temperature.
	Wet items have been left sitting for too long	Remove items from washer as soon as the cycle is finished, or if items are not to be removed from the washer immediately select 'Wrinkle Free'.
	Wash temperature.	Consider the wash temperature you select for your coloured items. Lower the temperature if you are concerned.
Black or grey marks on clothes.	Correct amount of detergent.	Ensure the correct dose of detergent is used for the load size and soil level (refer to page 26).
	Washer needs to be cleaned.	Empty the machine and complete a 'Drum Clean' cycle (refer to page 36).
Tangling	Items not sorted correctly	Separate larger items from smaller items.
	Washer loaded incorrectly.	Load items loosely and individually into the washer (ie not folded).
	Incorrect cycle for load type selected.	Use the 'Easy Iron' cycle to wash shirts
	Washer overloaded in terms of its capacity or the cycle selected.	Try washing average to smaller load sizes.
	Delicate items.	Wash pantyhose, bras and any other delicate items prone to tangling in a mesh laundry bag

Warning

This content is compiled from multiple sources and is provided for reference purposes only. It may not be complete or fully applicable to all situations. If you are unable to resolve your issue, please contact the product manufacturer or an authorized service provider for official support.

