

Package Contents

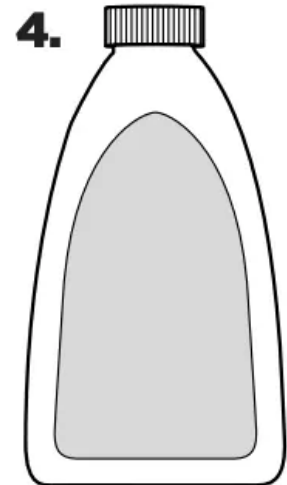

5.

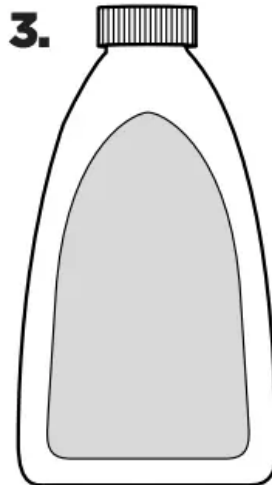
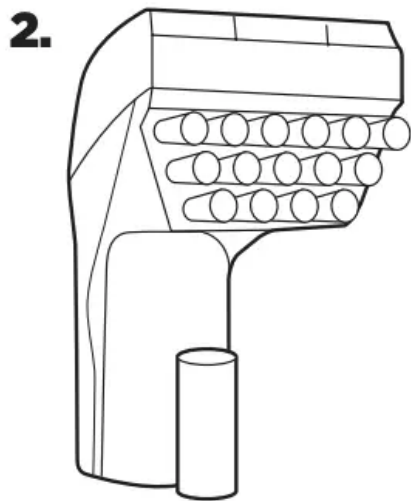
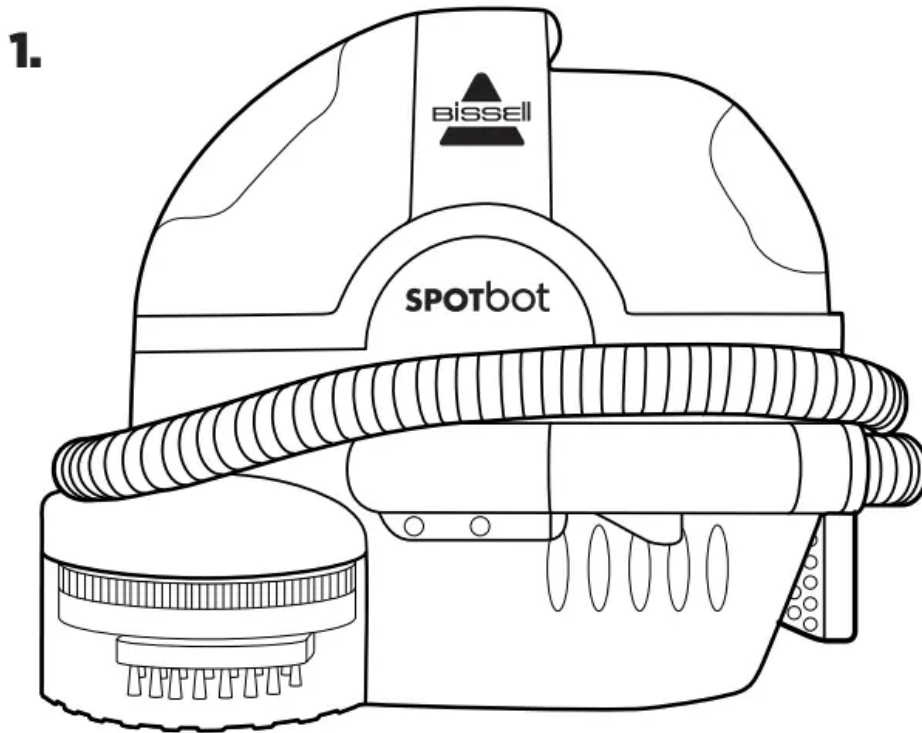

6.

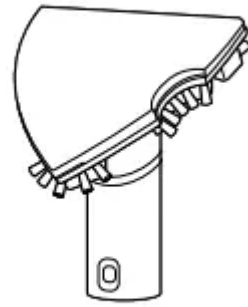

1. SpotBot® Unit
2. Tough Stain Tool
3. BISSELL Formula
4. BISSELL Boost Formula*
5. HydroRinse™ Self Cleaning Hose Tool*
6. 3-N-1 Stair Tool*

*Select models only.

Product View

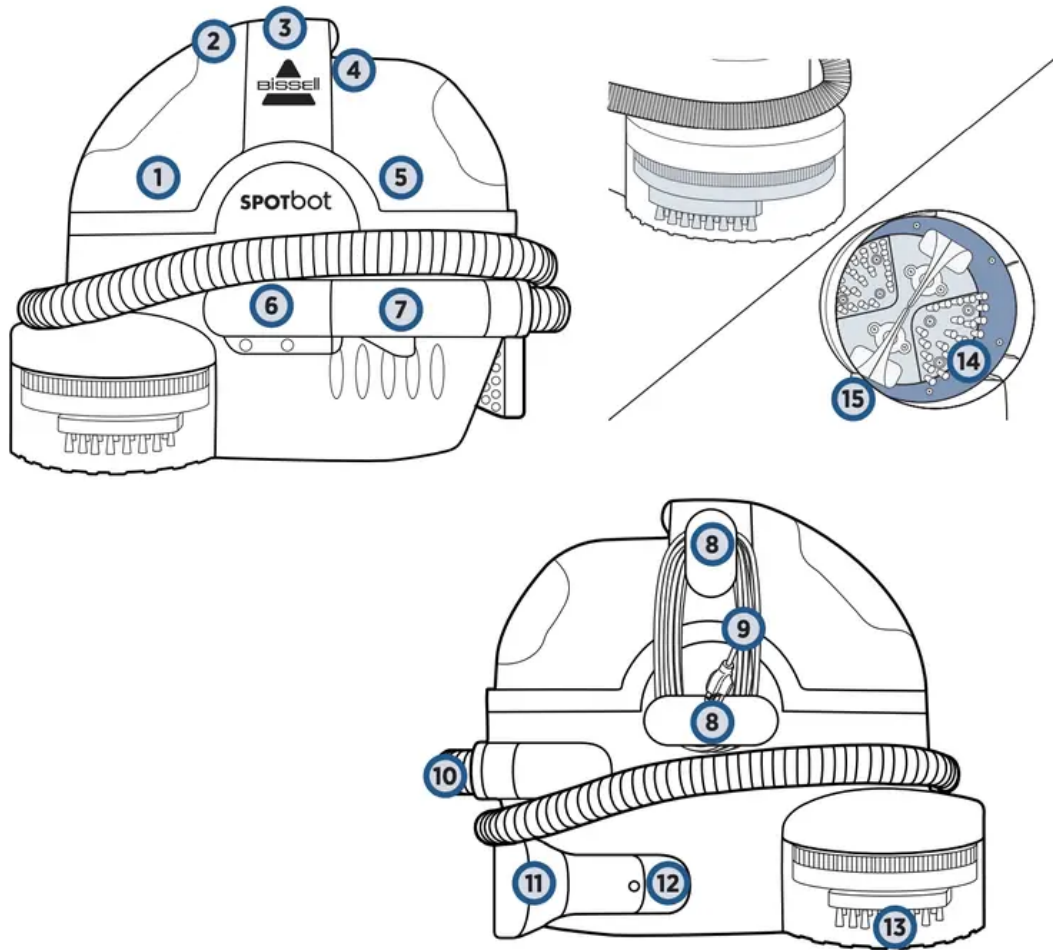

1. Dirty Water Tank
2. Tank Release Latch
3. Carry Handle
4. Automatic Smart System Control Panel
5. Clean Water/Solution Tank
6. Hose Connector
7. Spray Trigger
8. Cord Wraps
9. Power Cord
10. Vacuum Flex Hose
11. Tough Stain Tool
12. Tough Stain Tool Storage
13. Cleaning Window

14. Scrubbing Brushes

15. Suction Nozzles

WARNING: Do not plug in your deep cleaner until you are familiar with all instructions and operating procedures.

Special Features

Front view

4 - Preset Cleaning Cycles Control Panel

Located on top of the unit, you will find the control panel. Select the cleaning cycle you would like to use (detailed instructions on page 9). The “Power” and “Done” are not buttons; “Power” is an indicator light to tell you when the SpotBot® is “ON”. “Done” is an indicator light to tell you when the cleaning cycle is done.

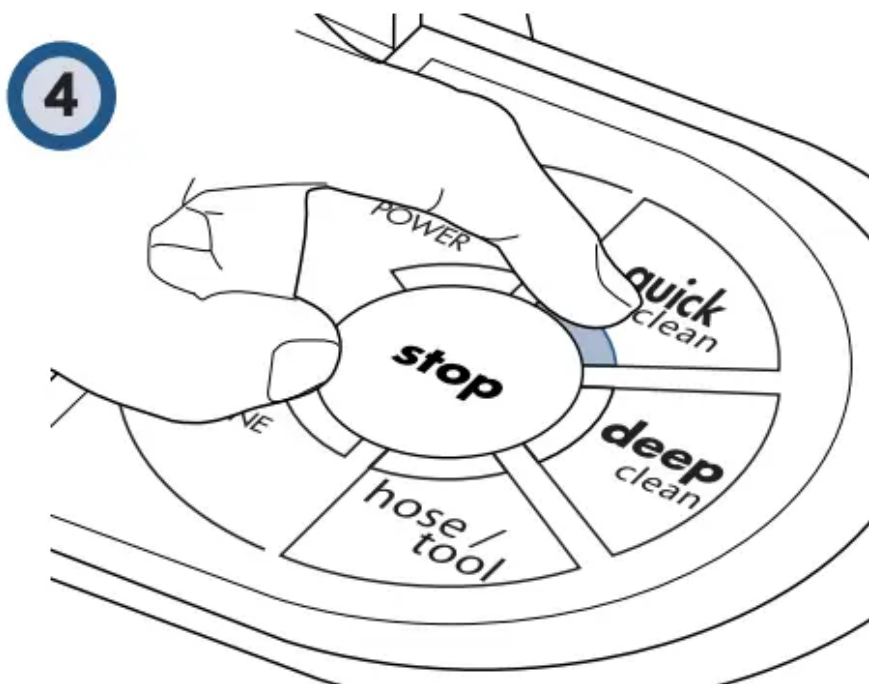

7 - Spray Trigger

Press the Spray Trigger to release water and formula onto the area to be cleaned. (Only use in hose/tool mode)

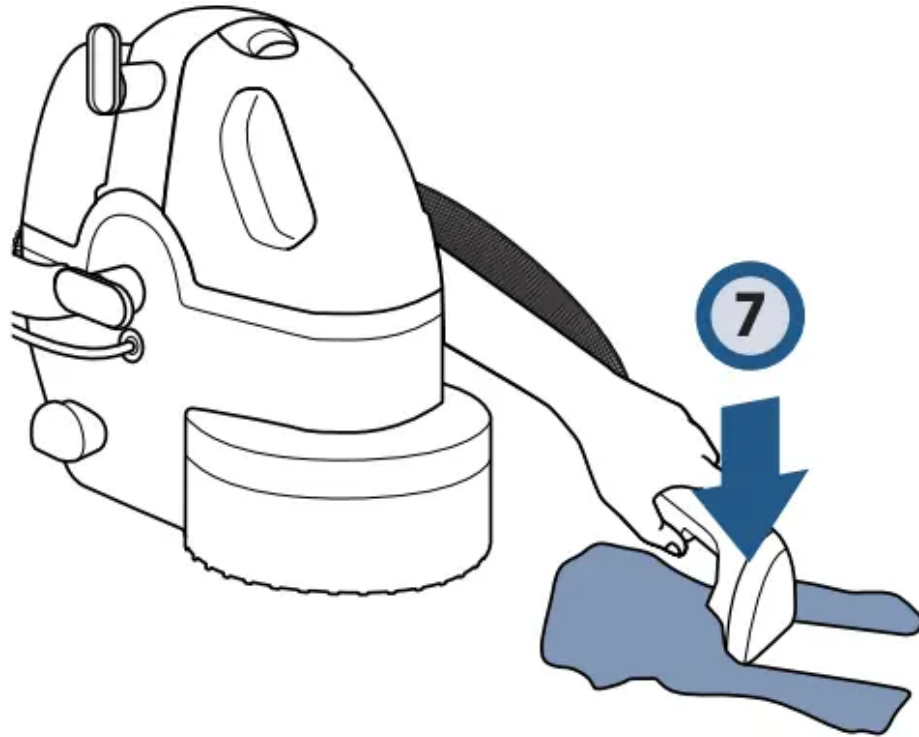

10 - Vacuum Flex Hose

Wraps around the center of the unit, and serves as the travel path for dirty water and formula suctioned into the Dirty Water Tank. The hose can also be unwrapped and used with the Tough Stain Tool for manual cleaning in hose/ tool mode.



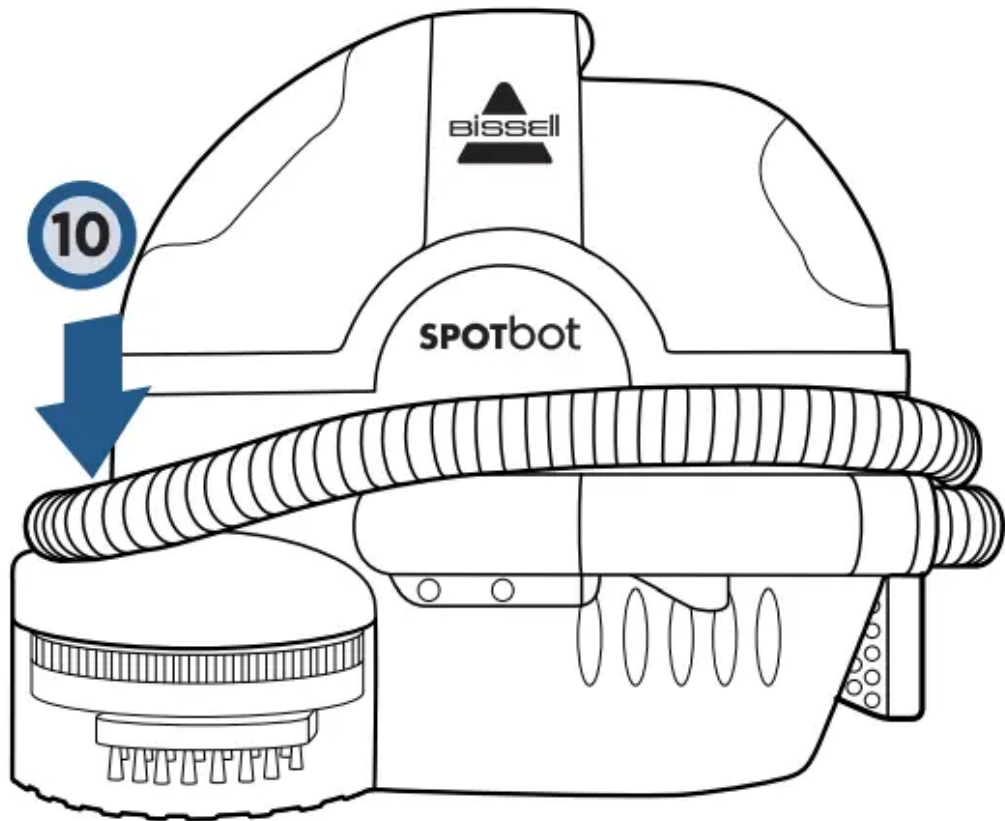

Back view

12 - Tough Stain Tool Storage

Stored on board for your convenience.

13 - Cleaning window

Provides an area to see the hands-free cleaning action.

NOTE: Unwrap Power Cord completely before operating the unit.

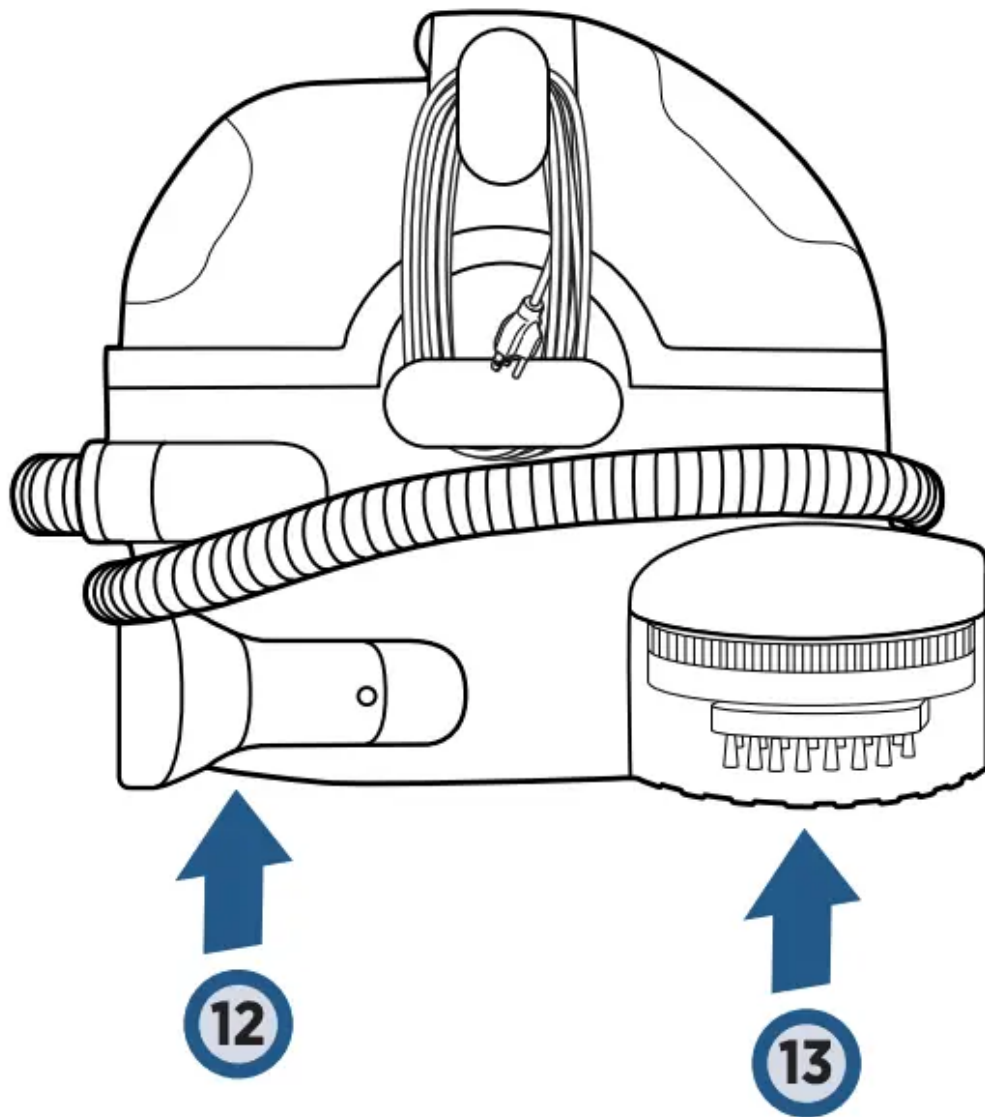

Underside view

14 - Scrubbing Brushes

Automatically spray, brush and remove both surface and tough stains and odors.

15 - Suction Nozzles

Provides suction path when using the hands-free cleaning cycles.

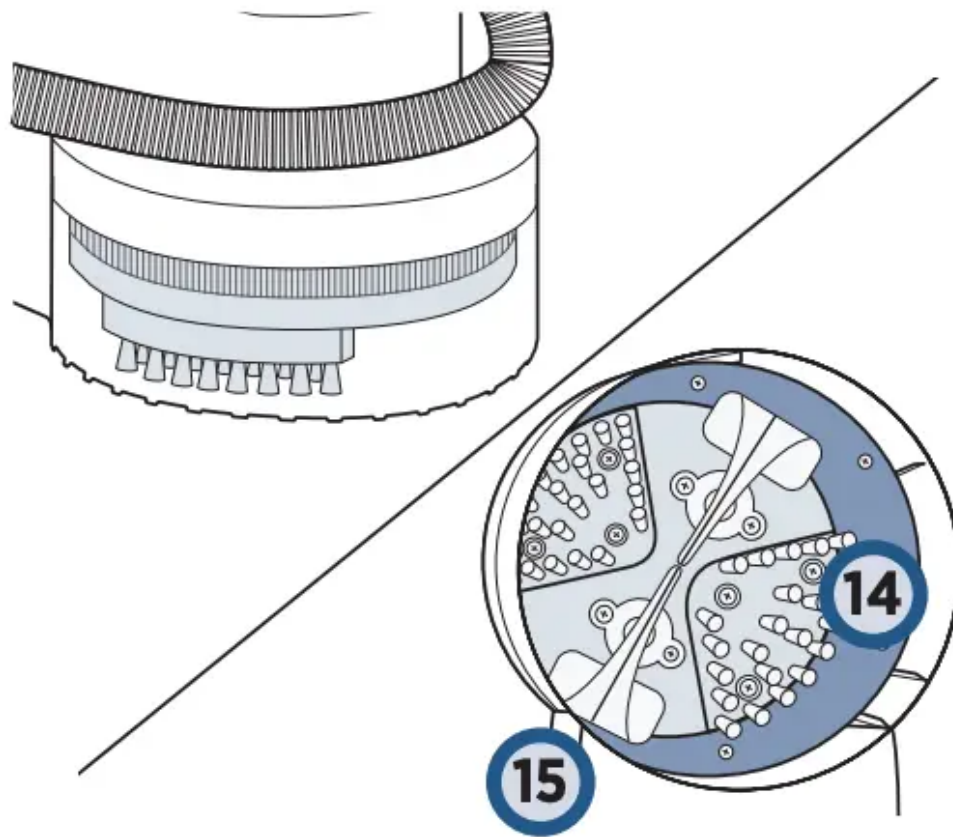

Cleaning Formulas

WARNING: To reduce the risk of fire and electric shock due to internal component damage, use only BISSELL® cleaning formulas intended for use with the deep cleaner.

NOTICE: Use only BISSELL portable machine formulas (with Boost if desired) in your cleaner. Use of cleaning formulas which contain lemon, pine oil or vinegar may damage this appliance and void the warranty. Chemical spot cleaners or solvent-based soil removers also should not be used. These products may react with the plastic materials used in your cleaner, causing cracking or pitting.

Always use genuine BISSELL deep cleaning formulas. Non-BISSELL cleaning solutions may harm the machine and may void the warranty.



A note about BISSELL formula

One of the effective stain removing ingredients in Oxy Boost and Pet Oxy Boost is Hydrogen Peroxide. Certain people may be affected by the product when it comes into contact with their skin; it may turn the skin white and/ or cause tingling. Washing your hands after use and applying hand lotion will remove any possible white discoloration.

Filling Your Clean Water Tank: Portable Machine Formula (2X Concentrated)

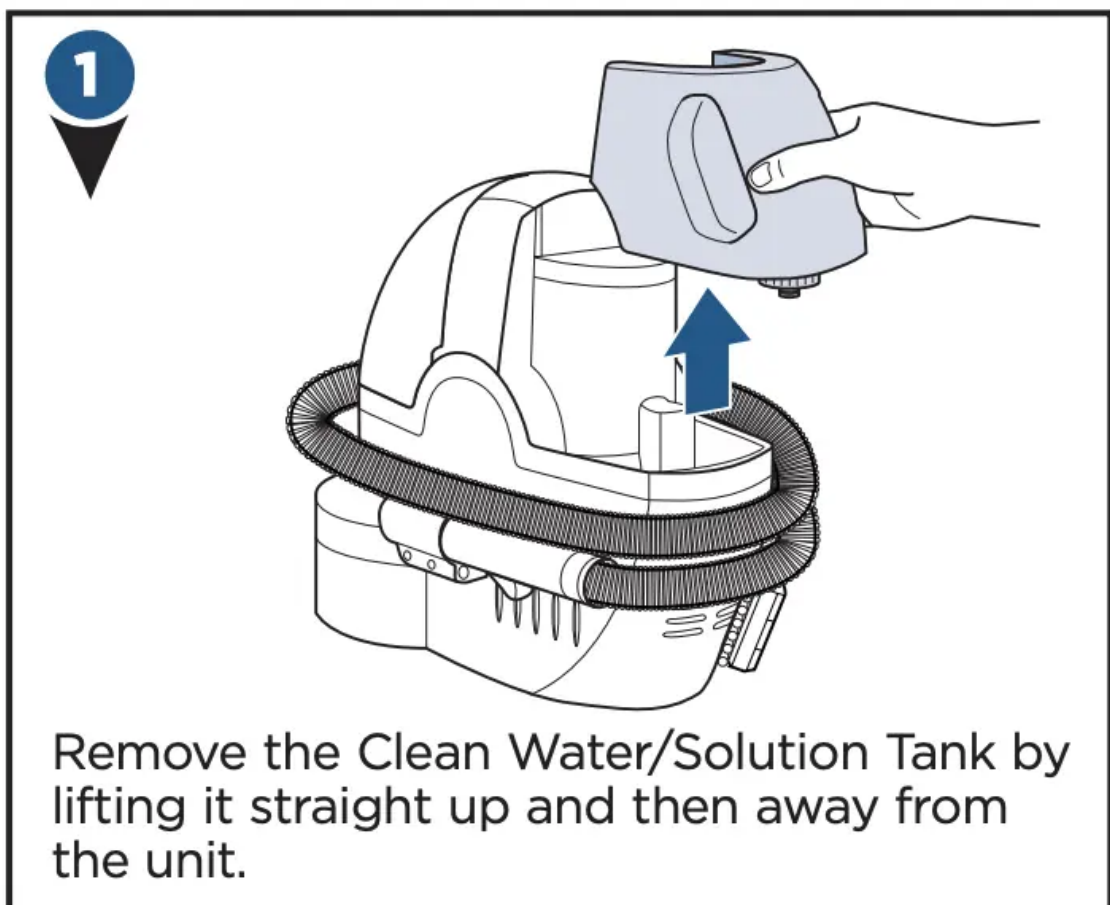

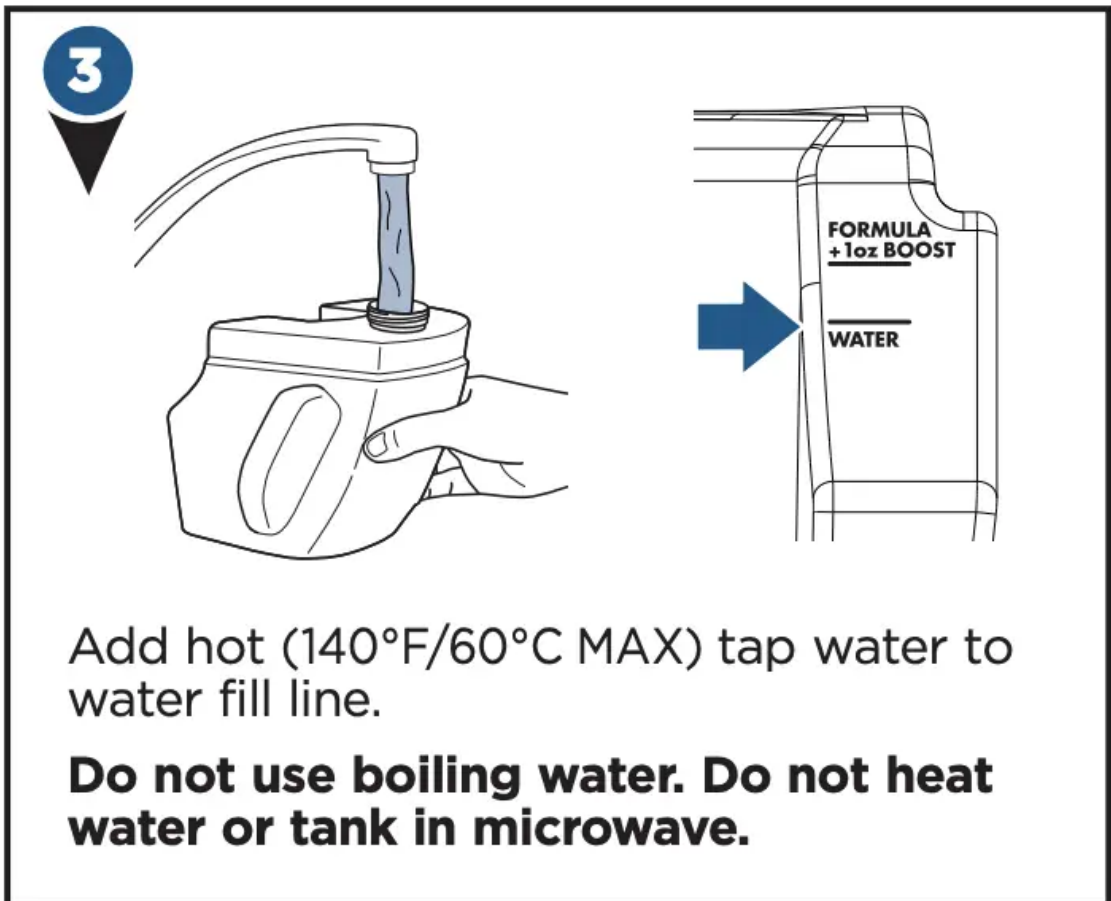
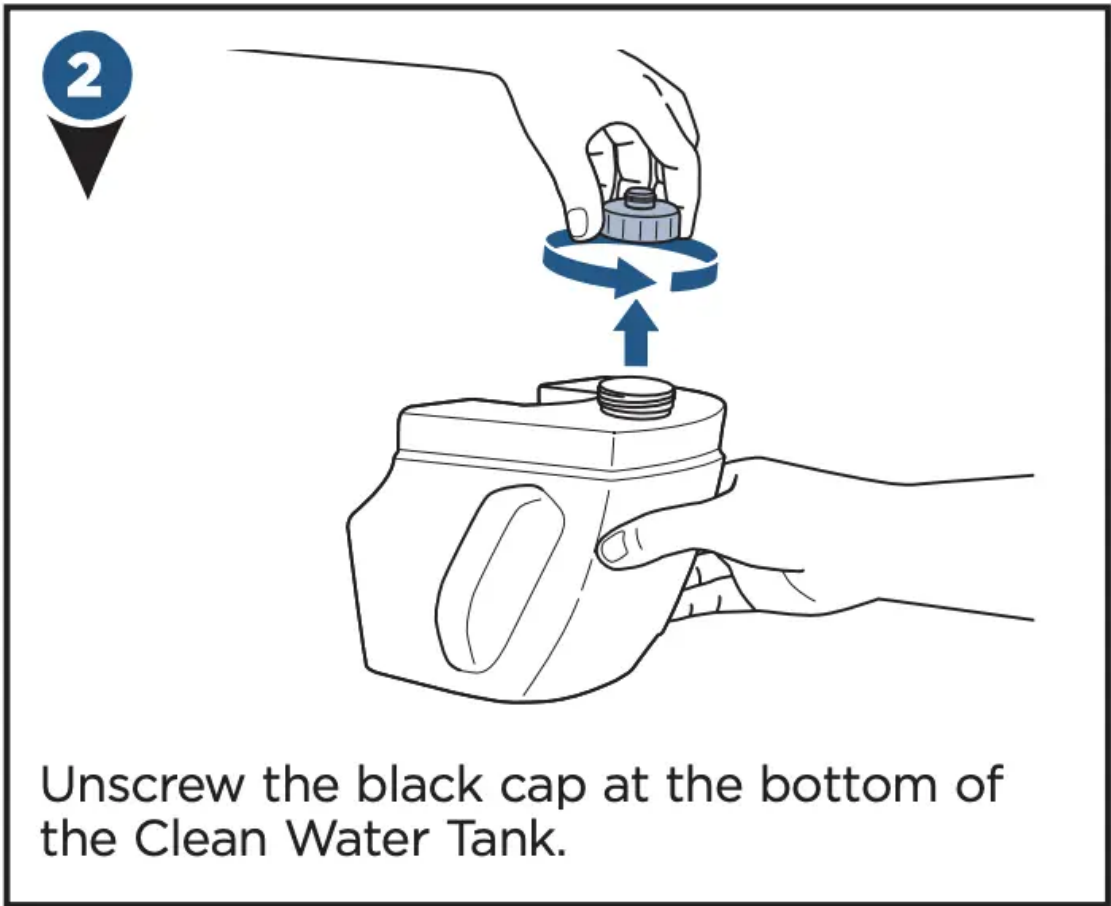

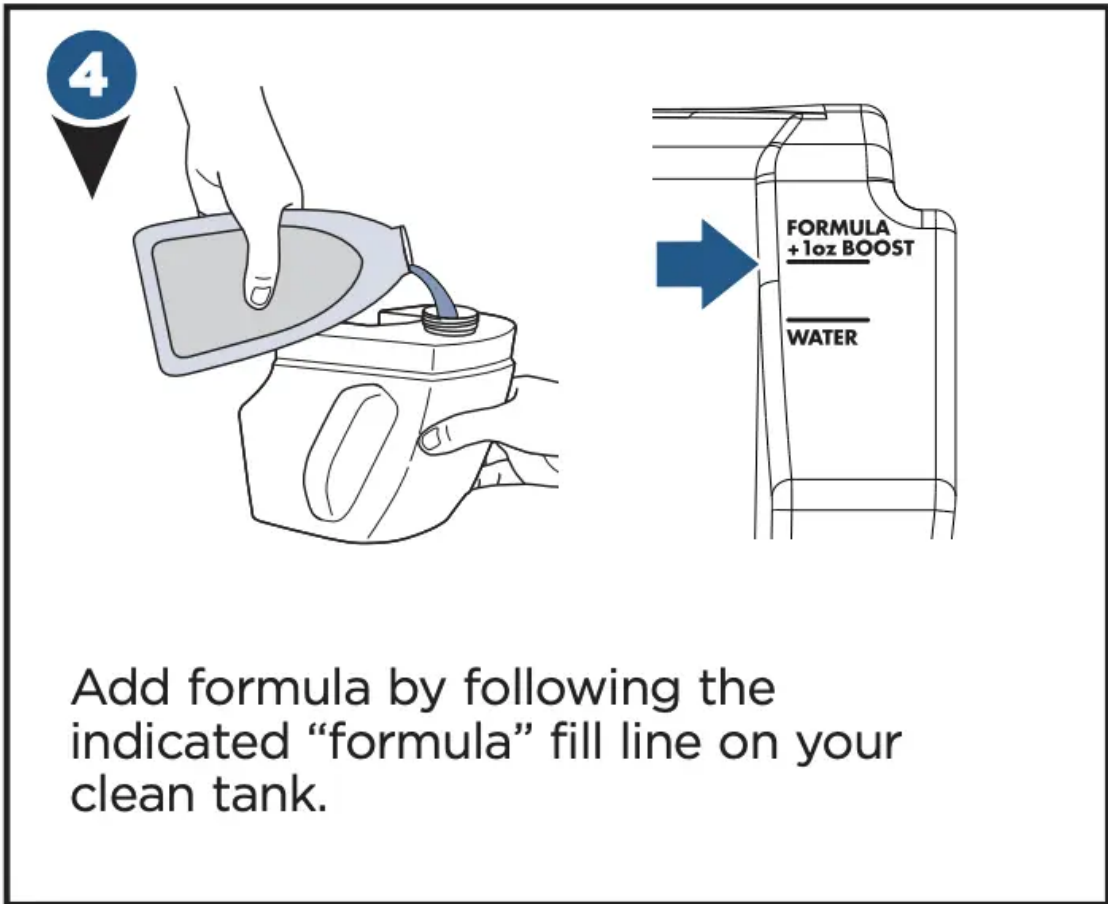

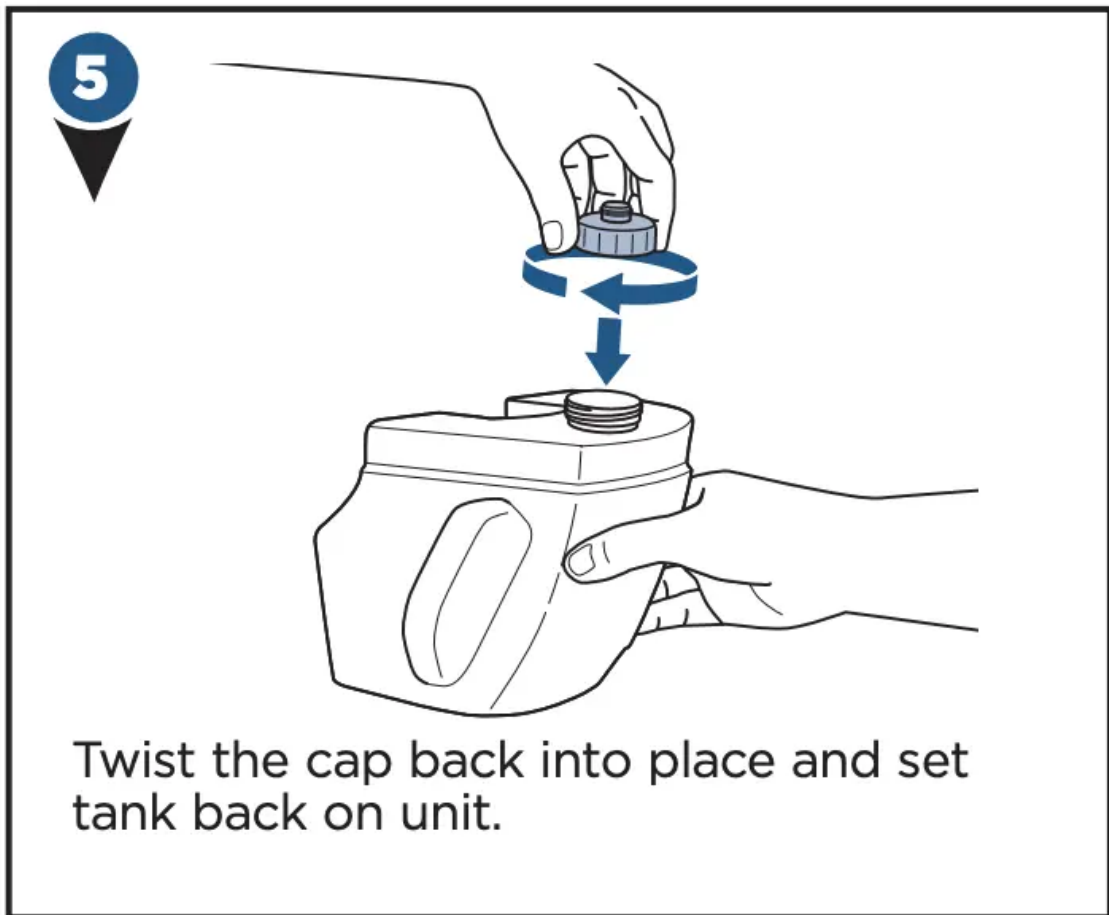

Using the Automatic Cleaning Cycles

Tips Before Using Your SpotBot®

- Dry vacuum the area first, before spot cleaning with the SpotBot.
- Some spots and spills require that you pick up the chunky debris with a rag or towel before you begin cleaning in the automatic or manual cycles.

1

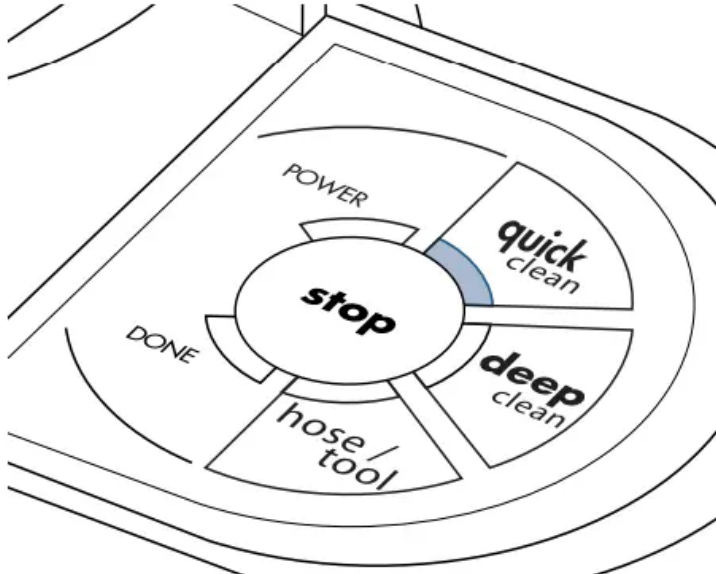

The diagram shows a control panel with a central 'stop' button. Surrounding it are four buttons: 'POWER' at the top, 'DONE' on the left, 'hose / tool' at the bottom, and 'quick clean' on the right. The 'quick clean' button is highlighted with a blue arc, indicating it is the selected mode.

Quick Clean This cycle has been designed for stains that are on the surface of your carpeting. This cycle will run for approximately 3 minutes.

2

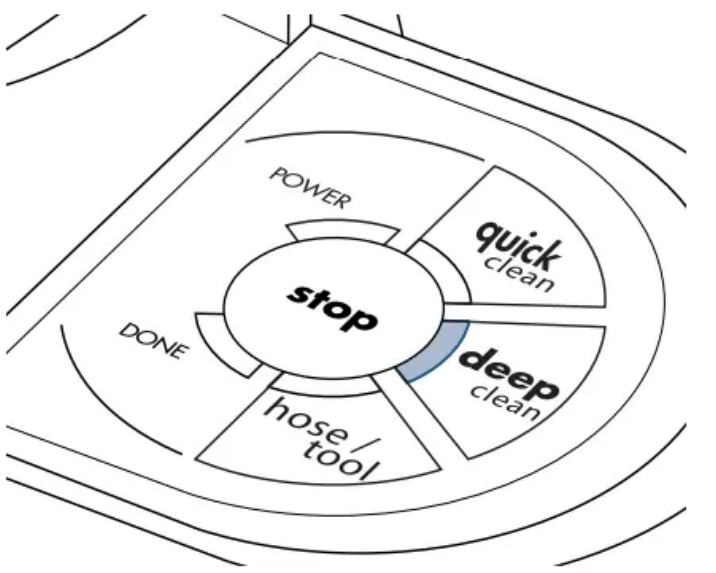

The diagram shows a control panel with a central 'stop' button. Surrounding it are four buttons: 'POWER' at the top, 'DONE' on the left, 'hose / tool' at the bottom, and 'quick clean' on the right. The 'deep clean' button is highlighted with a blue arc, indicating it is the selected mode.

Deep Clean Use on stains that have had time to set-in. These are typically the most difficult stain types to remove. This cycle runs for approximately 6 minutes.

3

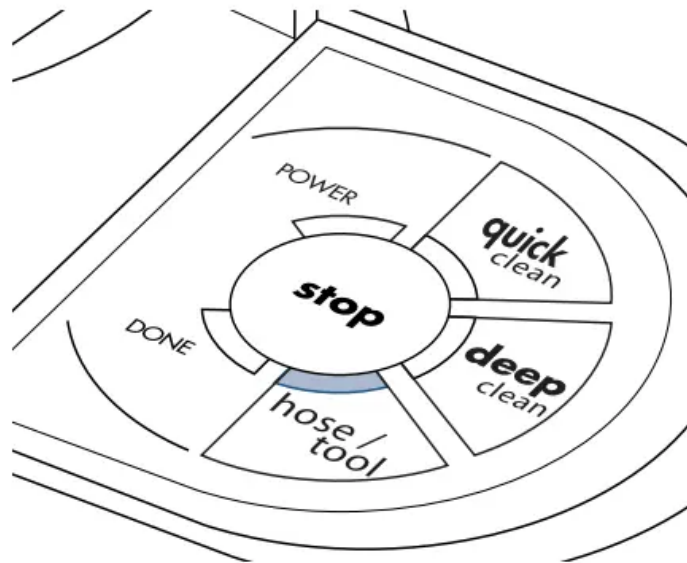

Hose/Tool By selecting this option you can clean spots and stains using the hose and tool on surfaces such as upholstery, stairs, car interiors or any other hard to reach area.

4

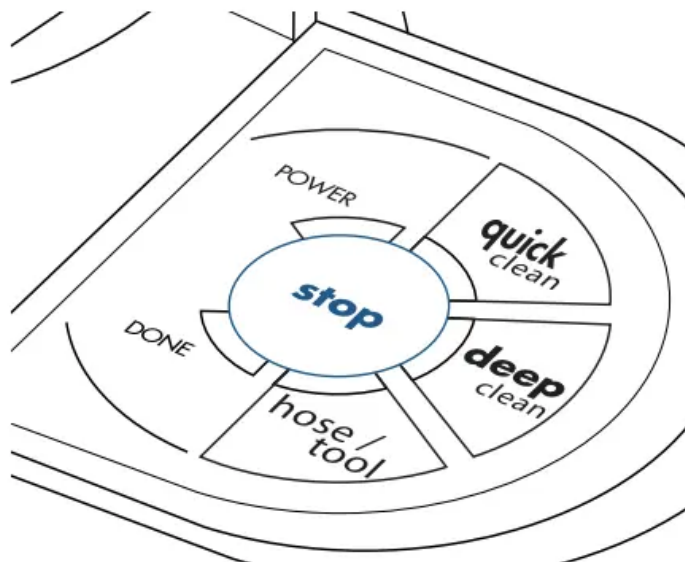

Stop By pressing the red stop button, you will stop the cleaning cycle completely. To begin cleaning again, you will need to start over and select a cleaning cycle.

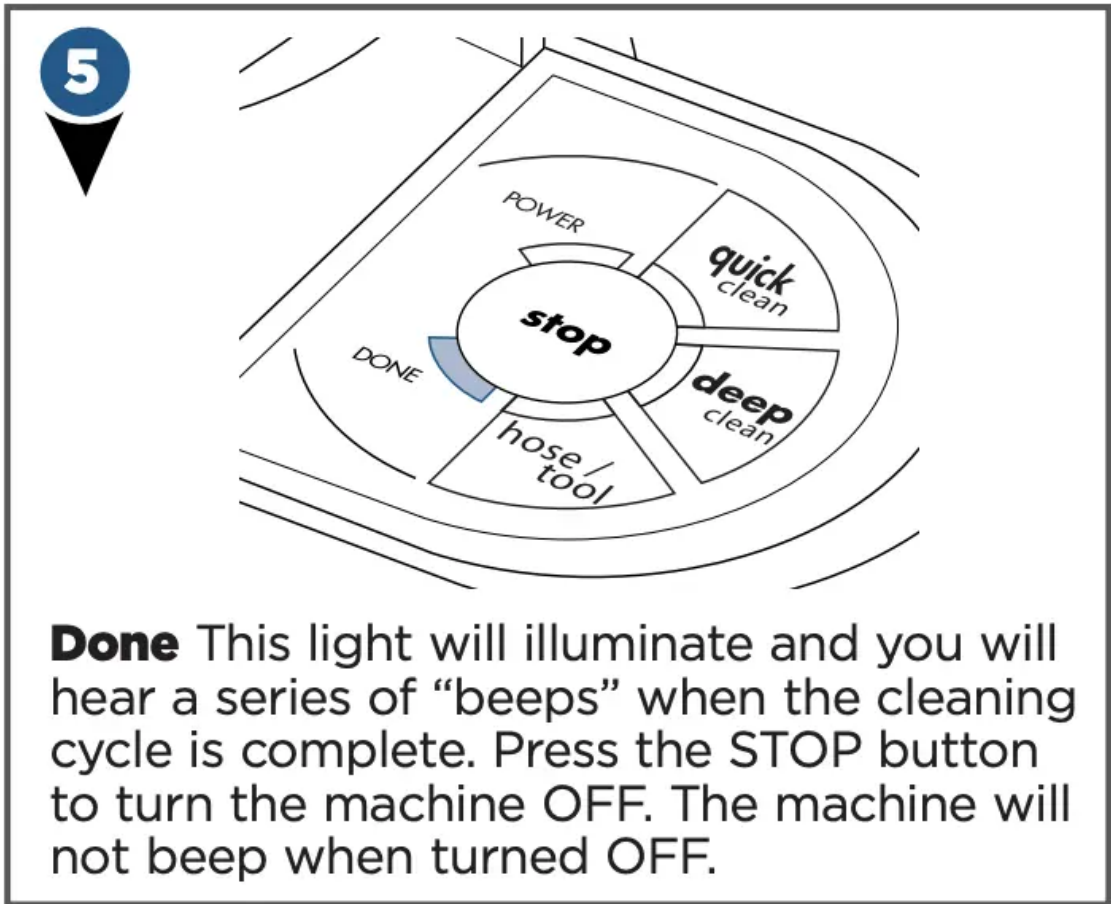

WARNING: Keep spray away from face. Failure to do so may result in personal injury.

Getting Started

Important! Please check manufacturer’s tag before cleaning area rugs for any specialized cleaning instructions. Not for use on silk or delicate area rugs.

1. Before using, test a small inconspicuous area for colorfastness.
2. Select “Hose/Tool” and follow manual cleaning instructions on page 10 to test.

Hands-Free Cleaning

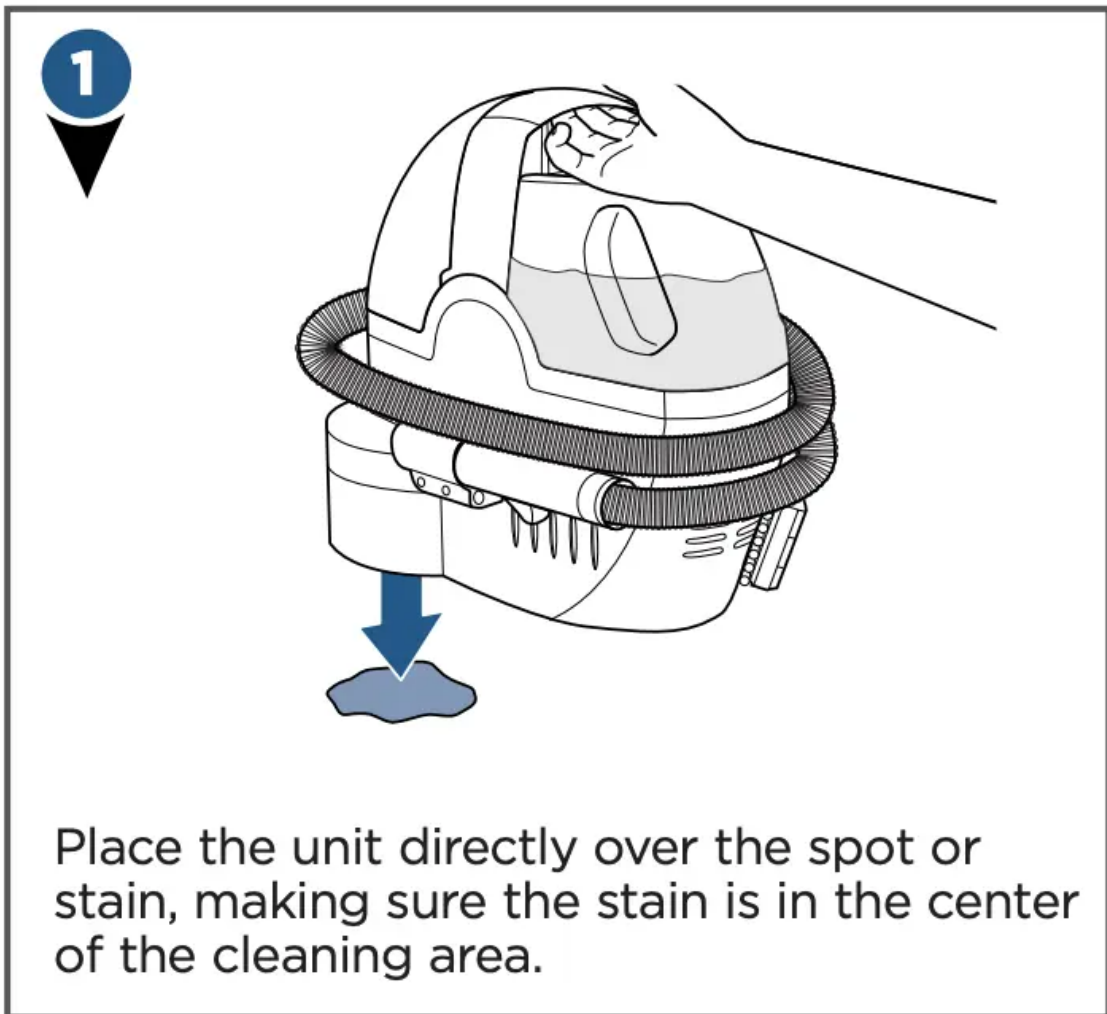

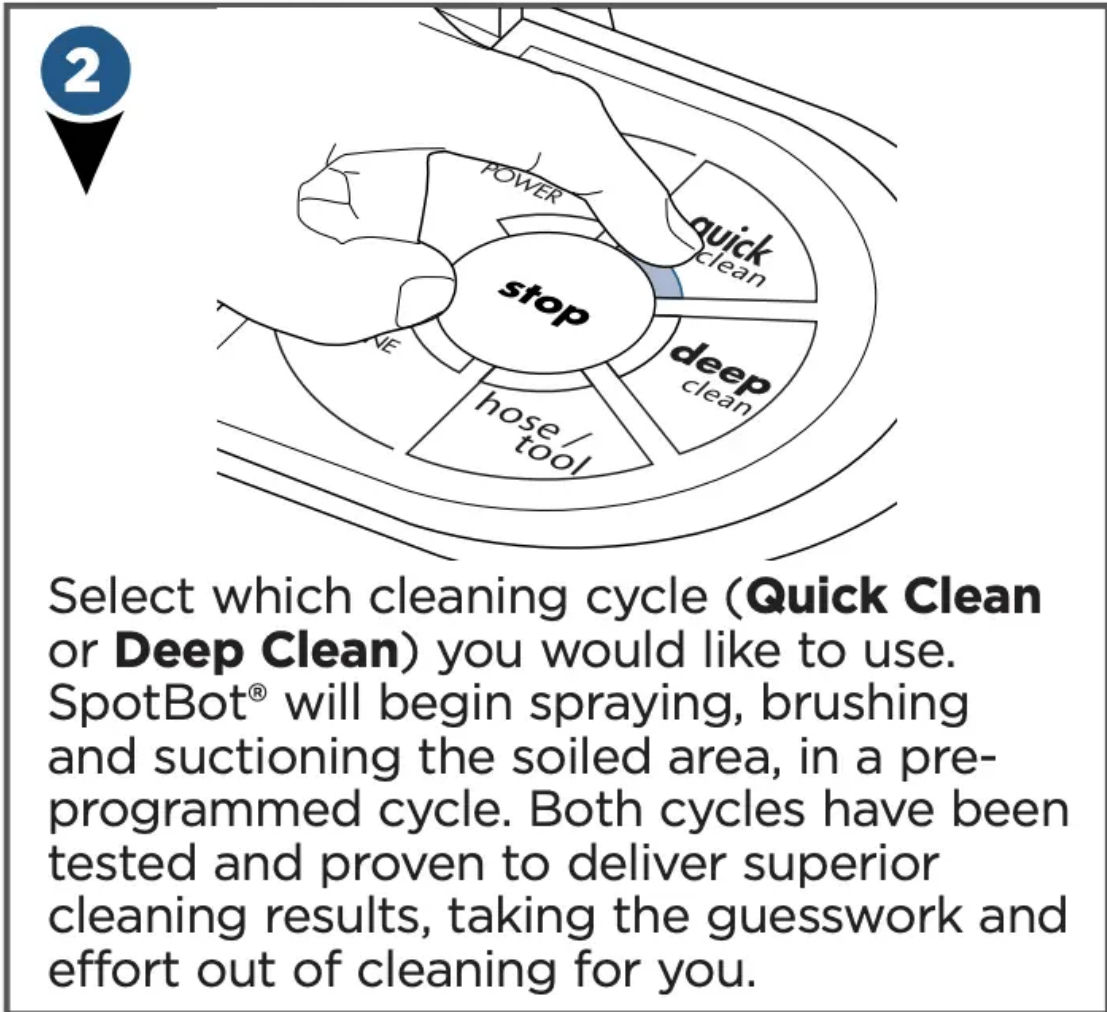

Select which cleaning cycle (**Quick Clean** or **Deep Clean**) you would like to use. SpotBot® will begin spraying, brushing and suctioning the soiled area, in a pre-programmed cycle. Both cycles have been tested and proven to deliver superior cleaning results, taking the guesswork and effort out of cleaning for you.

3

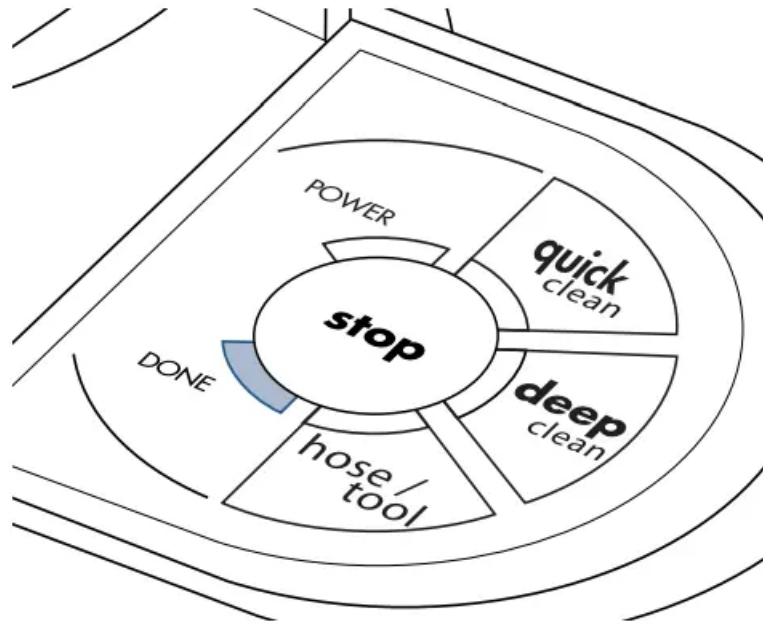

When the cleaning cycle you have selected is complete, the Done light will illuminate and the machine will sound a series of “beeps”. Press the **STOP** button to turn the machine OFF. The machine will not beep when turned OFF

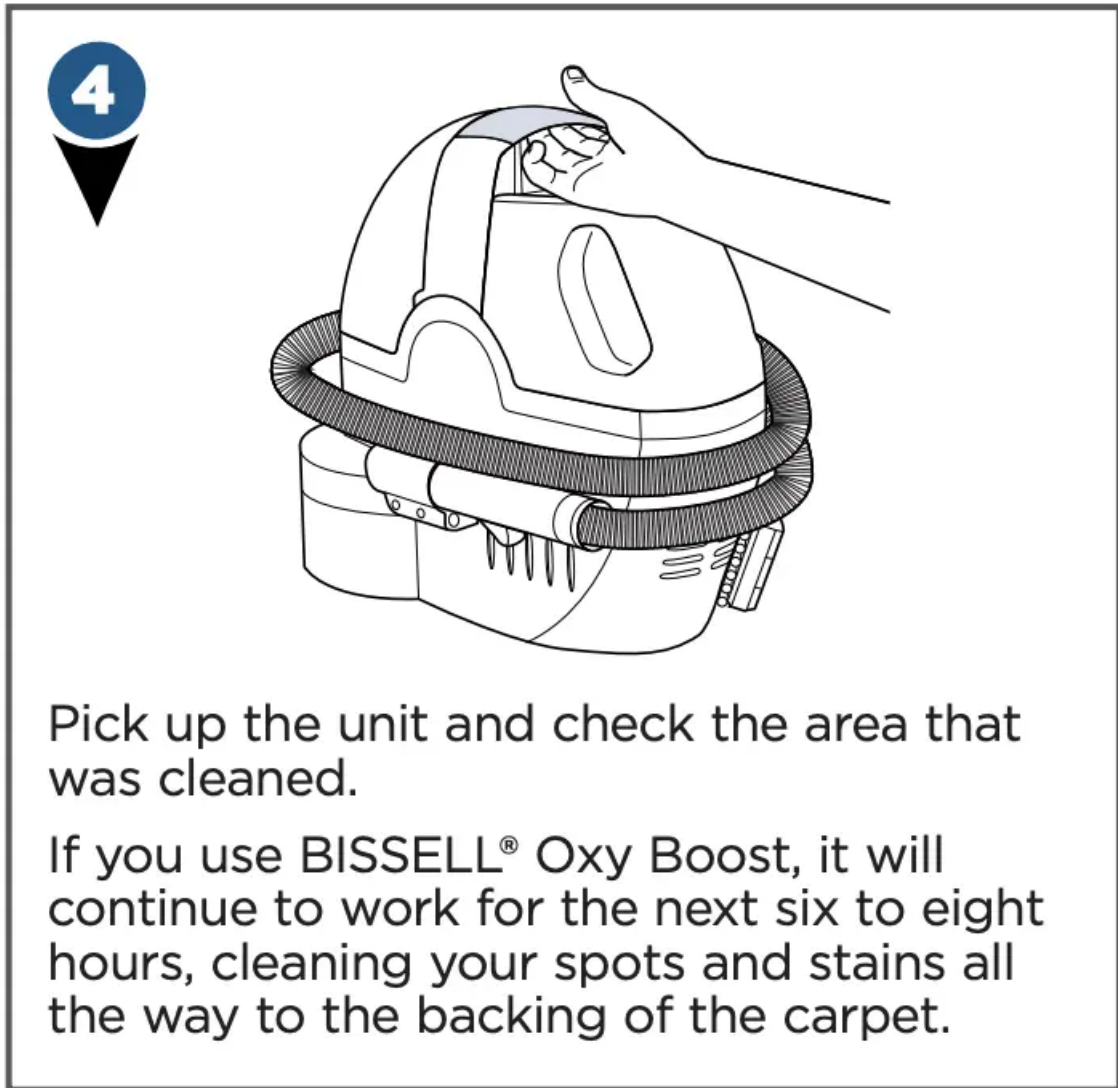

NOTICE: To prevent damage to Berber carpets, avoid repeated cleaning cycles in the same area.

Manual Cleaning

Check upholstery stuffing before cleaning. Colored stuffing may bleed through the fabric when it becomes wet. Check manufacturer's tag before cleaning.

1

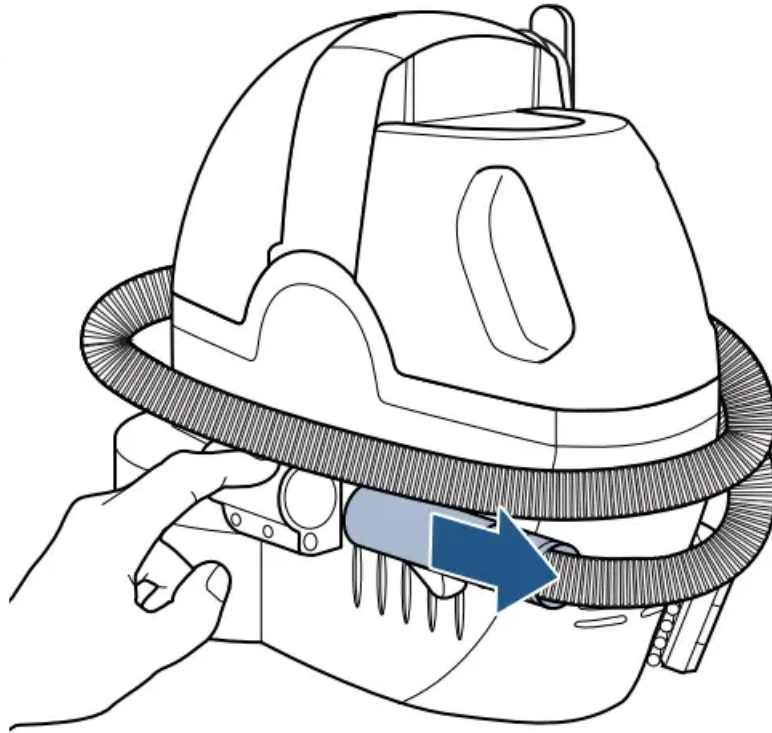

Remove the hose from the unit by pressing the release button and pulling outward on end of hose.

2

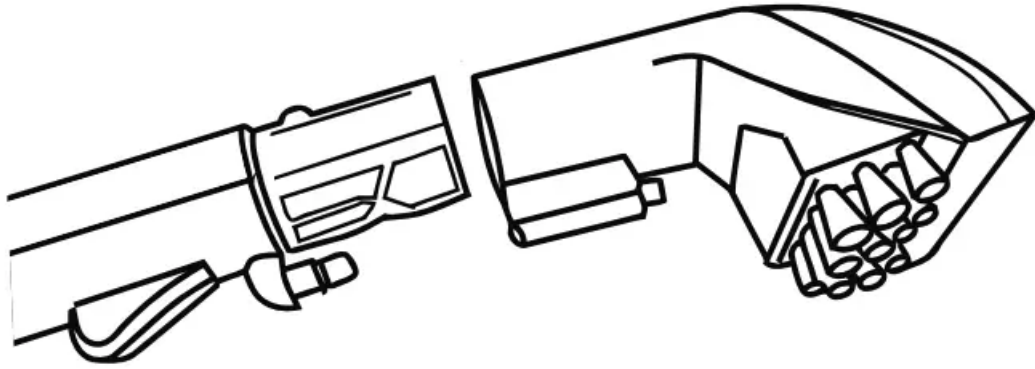

Remove the Tough Stain Tool from the back of the unit, then attach it onto the grip of the hose.

3

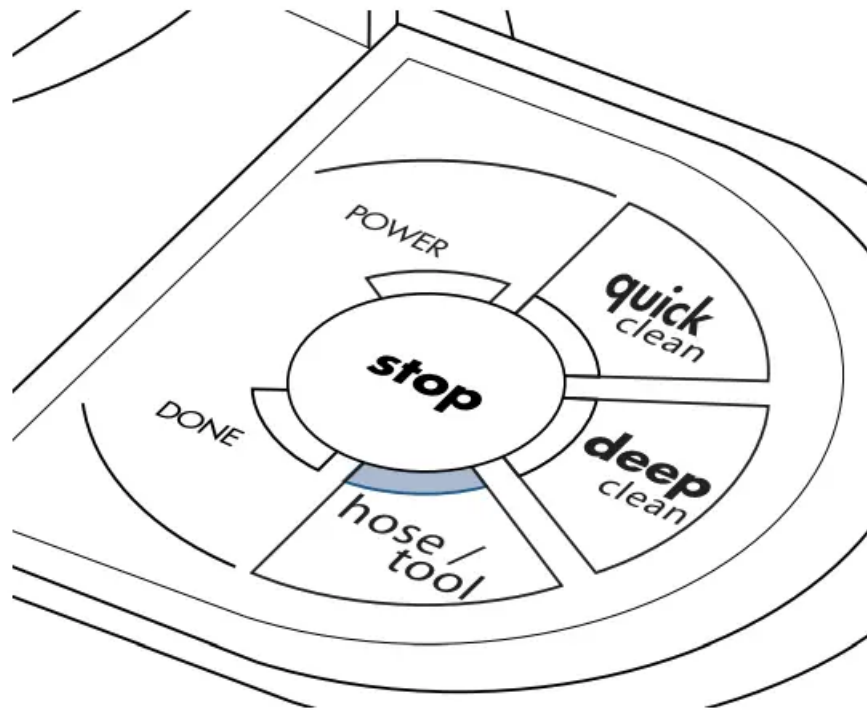

Select the **Hose/Tool** button on the control panel to start the SpotBot®.

4

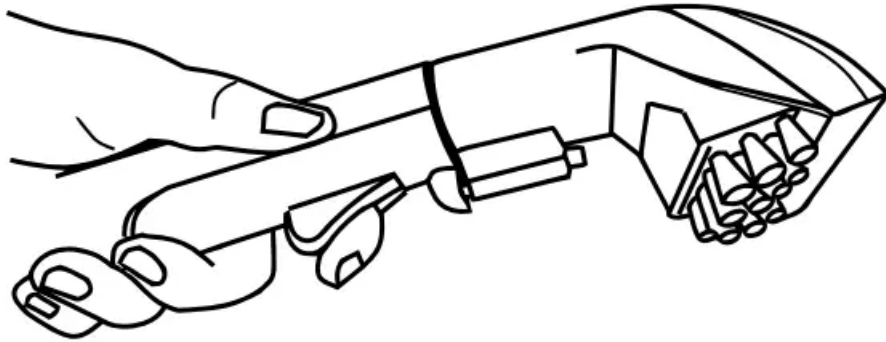

Press the Spray Trigger button to spray the soiled area, then slowly move tool back and forth over the area.

Release the trigger to suck up the dirty solution. Work in small sections until the area is clean.

5

If the stain is still visible, repeat step 4 as necessary.

NOTE: In manual mode, the SpotBot® is equipped with a safety feature which will shut the unit OFF after 30 minutes.

6

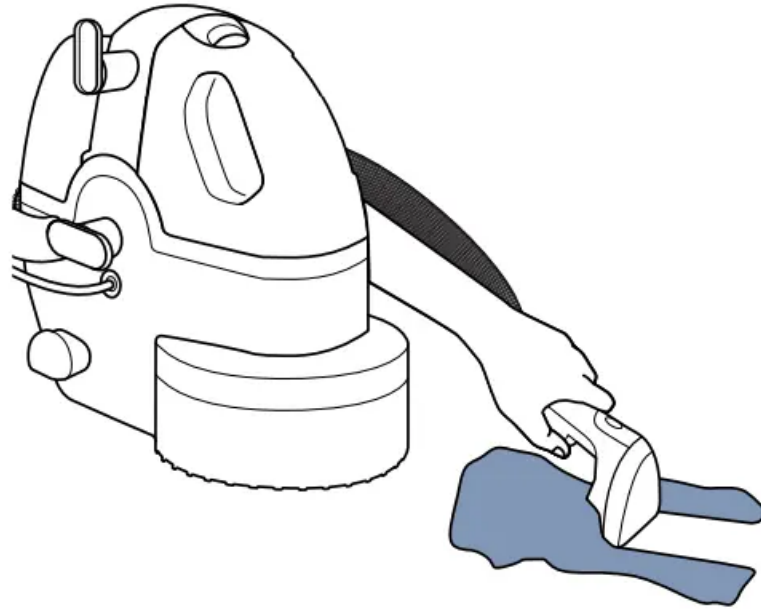

When the cleaning is complete, lightly drag the suction nozzle across the stain without pressing the trigger. This will help dry the cleaned area.

7

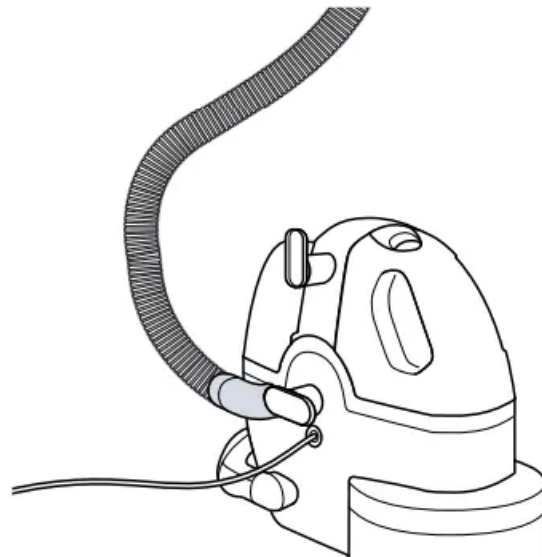

Before turning OFF the SpotBot®, suction up clean water to thoroughly rinse out the inside of the Vacuum Flex Hose. Then, lift the Vacuum Flex Hose upwards to drain any remaining water into the dirty tank.

8

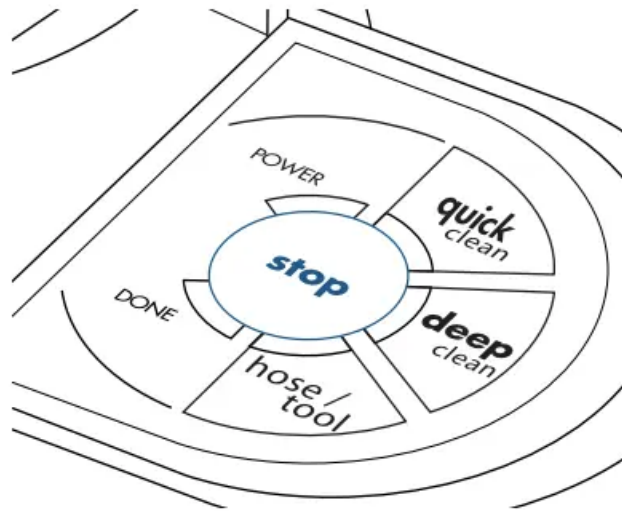

Press the **STOP** button to turn OFF the machine, then disconnect the cleaning tool from the Vacuum Flex Hose by pushing down on the button lock and pulling straight off (do not twist tools to remove them).

9

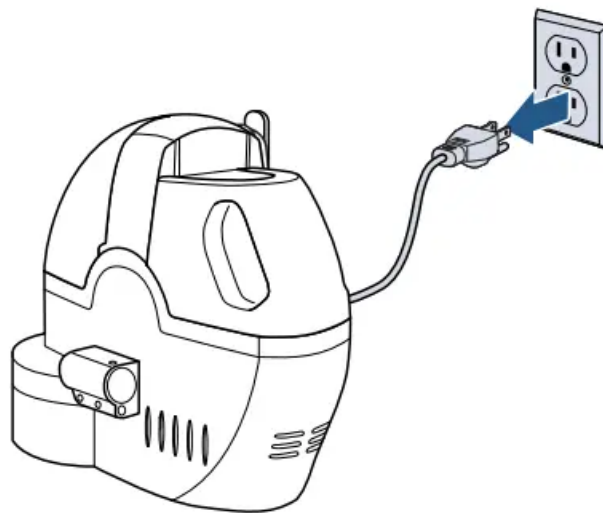

Unplug the machine and wrap the cord around the Cord Wraps. Attach the Tough Stain Brush to the base of machine. Wrap the hose around the machine and secure into the Hose Connector.

Tips While Cleaning

- Periodically clean out the black valve inside of the Dirty Water Tank.

Cleaning with Tools

WARNING: Keep spray away from face. Failure to do so may result in personal injury.

CLEANING WITH THE 3-N-1 STAIR TOOL (select models)

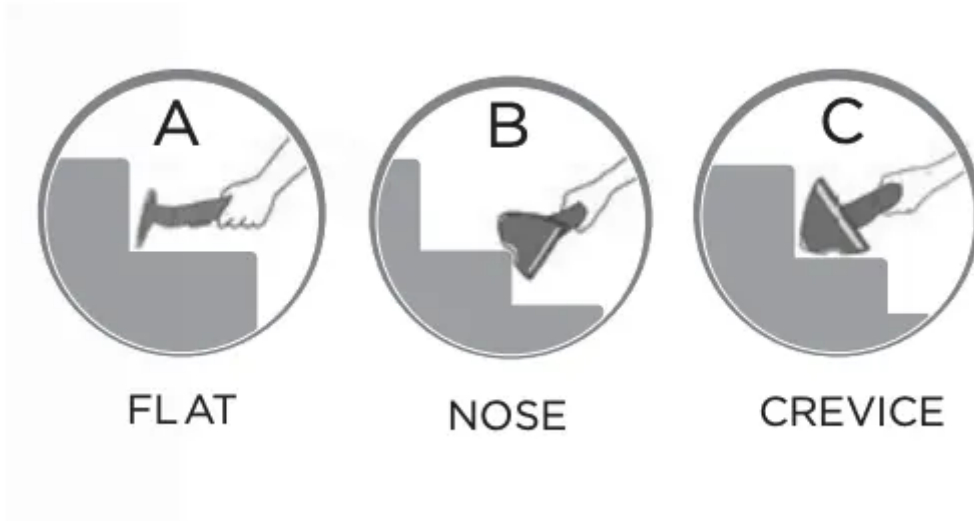

Attach the 3-n-1 Stair Tool to the cleaning hose. This versatile 3-way tool sprays, scrubs and suctions up dirt and stains from the outer curves, corner and tread of a carpeted stairs. Twist the tool head to desired setting to clean. The downward facing edge is the active cleaning mode: (a) use the flat area to clean top of stairs, (b) use pointed edge to clean inside crevice, (c) use indented area to clean outer corner.

CLEANING WITH THE HYDRORINSE™ TOOL (select models)

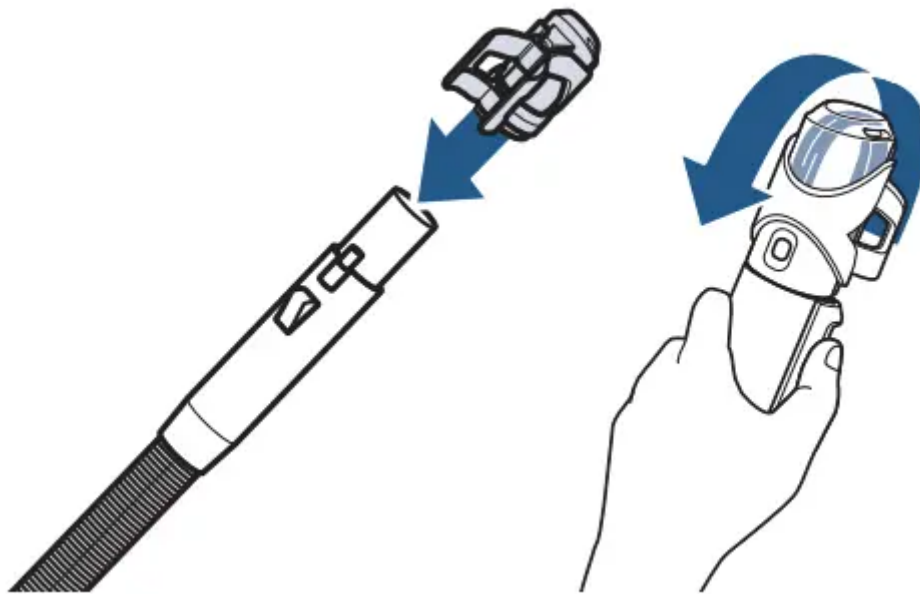

Attach the HyrdoRinse™ tool to the cleaning hose.

Hold the hose and attachment in an upright position. Then **hold down the trigger** to rinse the hose for 30 seconds.

The HydroRinse tool can be stored on the right handle or on the hose in between use.

Maintenance and Care

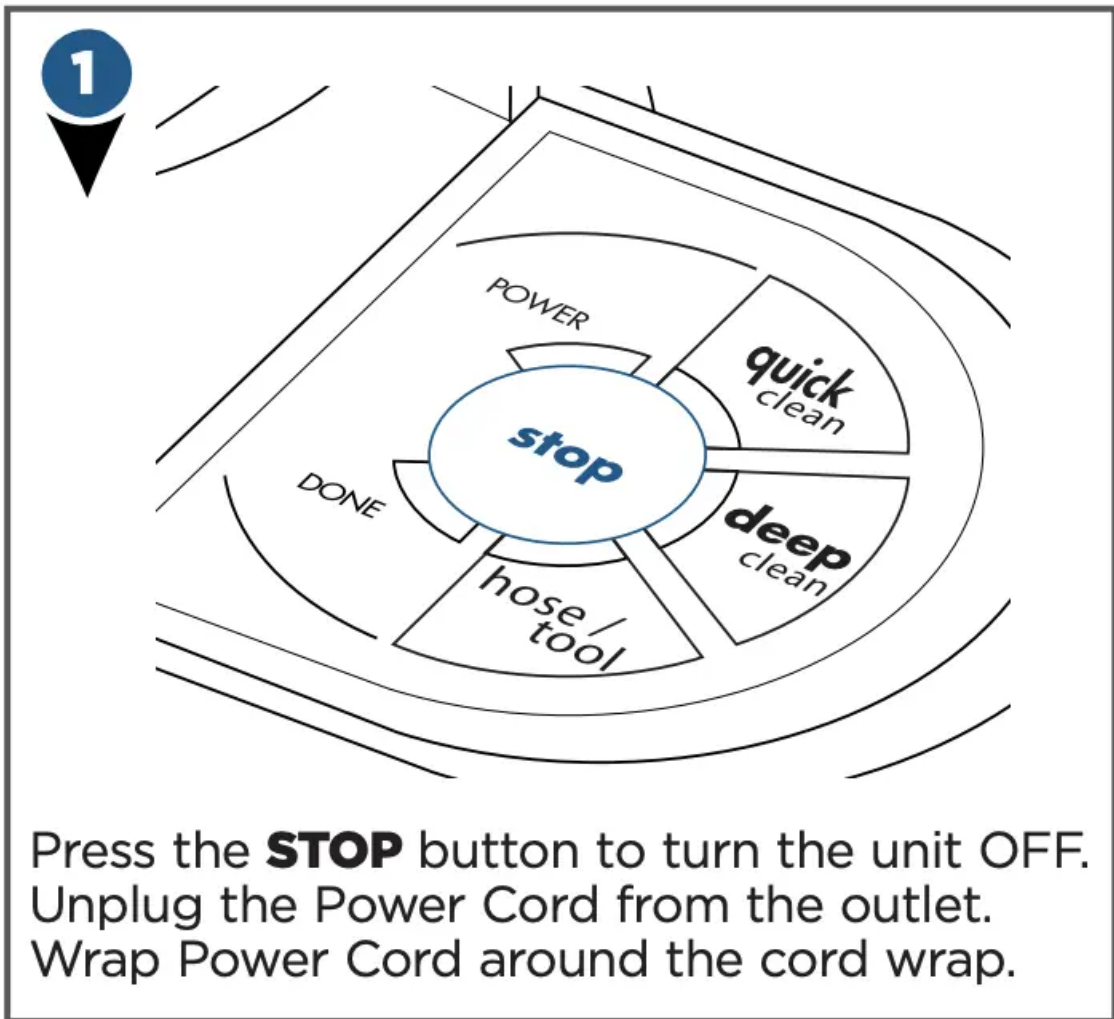

2

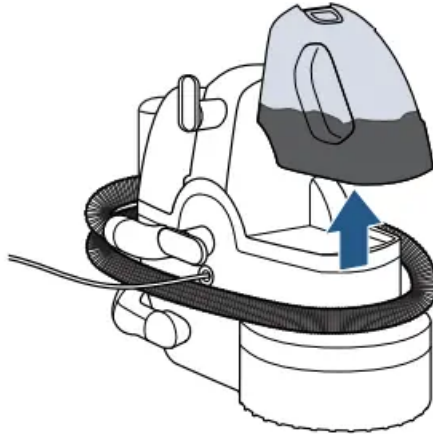

Empty and rinse the Dirty Water Tank after each use. To remove the tank, lift up the dirty tank latch and pull the tank out. Dump out the dirty water and rinse. Replace the tank into the unit for storage. After using the automated feature on SpotBot®, wipe the window and brushing area with a soft cloth.

3

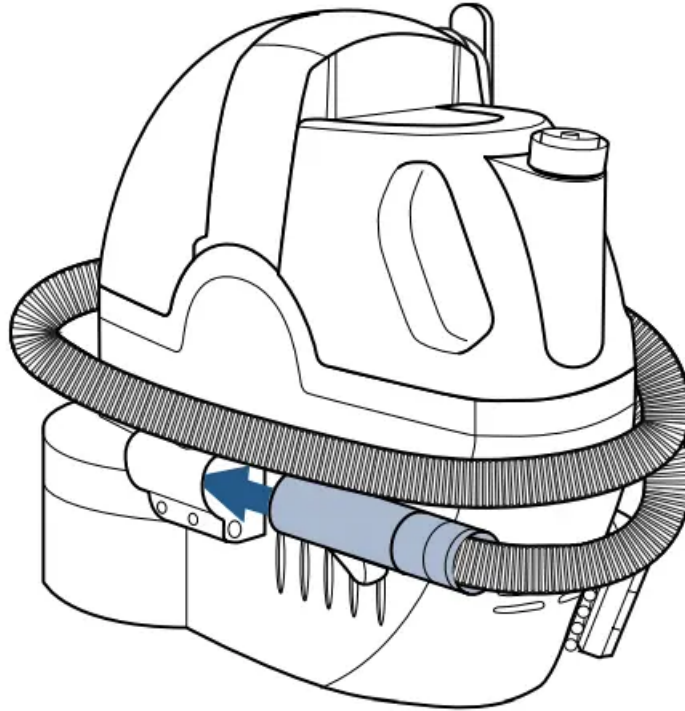

If you were using your SpotBot® manually, wrap the Vacuum Flex Hose around the unit and secure the hose into the Hose Connector on the front of the unit.

Tips for Storing

- If a significant amount of water and solution remains in the clean tank, your unit can be stored with liquid in the clean tank. However, if you have added Oxy Boost into the clean tank, it cannot be stored in the unit and should be emptied and rinsed.
- Keep your machine clean and clean out the black valve periodically inside of the Dirty Water Tank.
- Store machine in a protected, dry area.

NOTICE: To reduce the risk of a leaking condition, do not store unit where freezing may occur. Damage to internal components may result.

Troubleshooting

WARNING: To reduce the risk of electric shock, turn power OFF and disconnect plug from electrical outlet before performing maintenance or troubleshooting checks.

Problem	Possible causes	Remedies
AUTOMATED CLEANING		
SpotBot® will not run	Power Cord not plugged in	Check electrical plug
	Blown fuse/tripped breaker	Replace household fuse or reset breaker
	Vacuum Flex Hose is not snapped into place securely	Check to make sure the Vacuum Flex Hose is snapped into place
Unusual or odd noise	Clean Water/Solution Tank is out of fluid	Fill tank
Reduced or no spray	Clean Water/Solution tank is out of fluid	Fill tank
	Clean Water/Solution tank is not inserted into the unit securely	Gently press the tank until you see "bubbles" coming from the base
No suction	Tank is full	Empty tank
	Dirty Water Tank latch is not down	Push latch down, securely into place
	Black valve on the Dirty Water Tank is missing	Replace black valve onto tank
MANUAL CLEANING		
Cleaner will not run	Power Cord not plugged in	Check electrical plug
	Blown fuse/tripped breaker	Replace household fuse or reset breaker
	Hose not removed from receiver	Remove hose
	SpotBot® shut OFF automatically during use	Press Pause/Resume button to resume manual cleaning
Unusual or odd noise	Clean Water/Solution Tank is out of fluid	Fill tank
Reduced or no spray	Spray tip clogged on Tough Stain Tool	Clean spray tip

	Clean Water/Solution Tank is out of fluid	Fill tank
	Clean Water/Solution Tank is not inserted into the unit securely	Gently press the tank until you see "bubbles" coming from the base
No suction	Tank is full	Empty tank
	Dirty Water Tank latch is not down	Push latch down, securely into place
	Black valve on the Dirty Water Tank is missing	Replace black valve onto tank

Warning

This content is compiled from multiple sources and is provided for reference purposes only. It may not be complete or fully applicable to all situations. If you are unable to resolve your issue, please contact the product manufacturer or an authorized service provider for official support.

