

Preparations

Parts

Control Panel

The color and shape of parts may differ from what is shown. Specifications are subject to change without notice to improve quality.

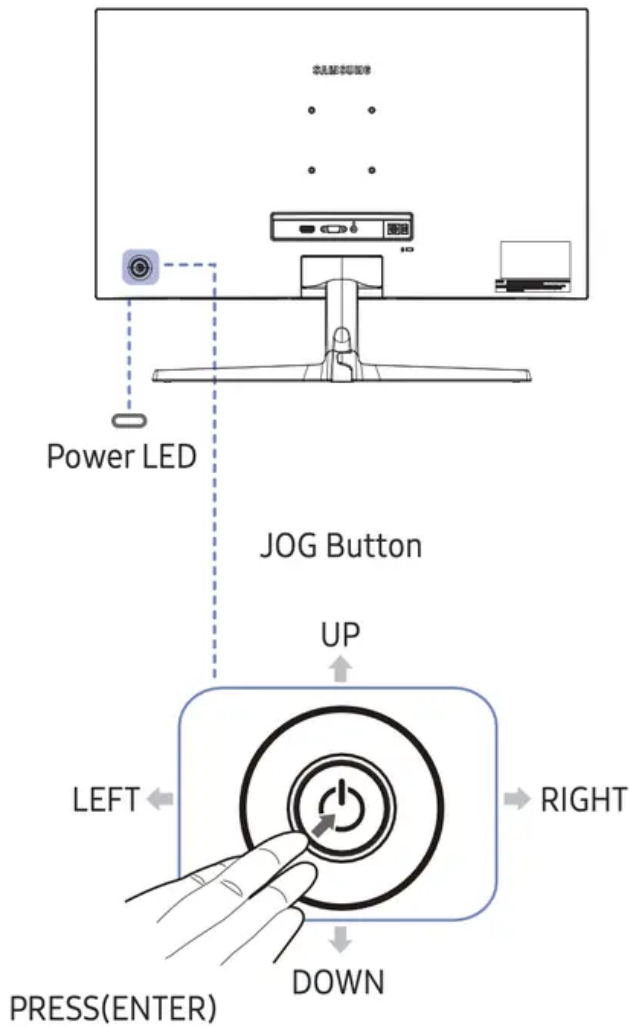

Function Key Guide

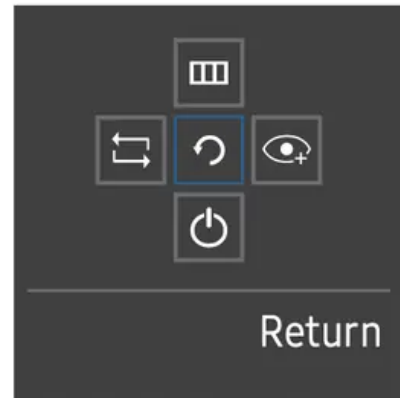

Icons	Description
JOG Button	<p>Multi directional button that helps navigate.</p> <ul style="list-style-type: none"> • The JOG button is located on the rear left side of the product. The button can be used to move up, down, left or right, or as Enter.
Power LED	<p>This LED is power status indicator and works as</p> <ul style="list-style-type: none"> • Power On (Power button): Off • Power saving mode: Blinking • Power Off (Power button): On <p>The power Indicator operation can be swapped by changing in the menu. (System > Power LED On) Actual models because of functional variation maybe haven't this function.</p>
Function Key Guide	<p>Press the JOG button when the screen is turned on. The Function Key Guide will appear. To access the onscreen menu when the guide is displayed, press the corresponding direction button again.</p> <ul style="list-style-type: none"> • Function Key Guide may vary depending on the function or product model. Please refer to the actual product.

Direct Key guide

The shortcut button screen (OSD menu) shown below is displayed only when the monitor screen is turned on, the computer resolution changes, or the input source changes.

The function buttons page shows if **Eye Saver Mode** is enabled.



: On





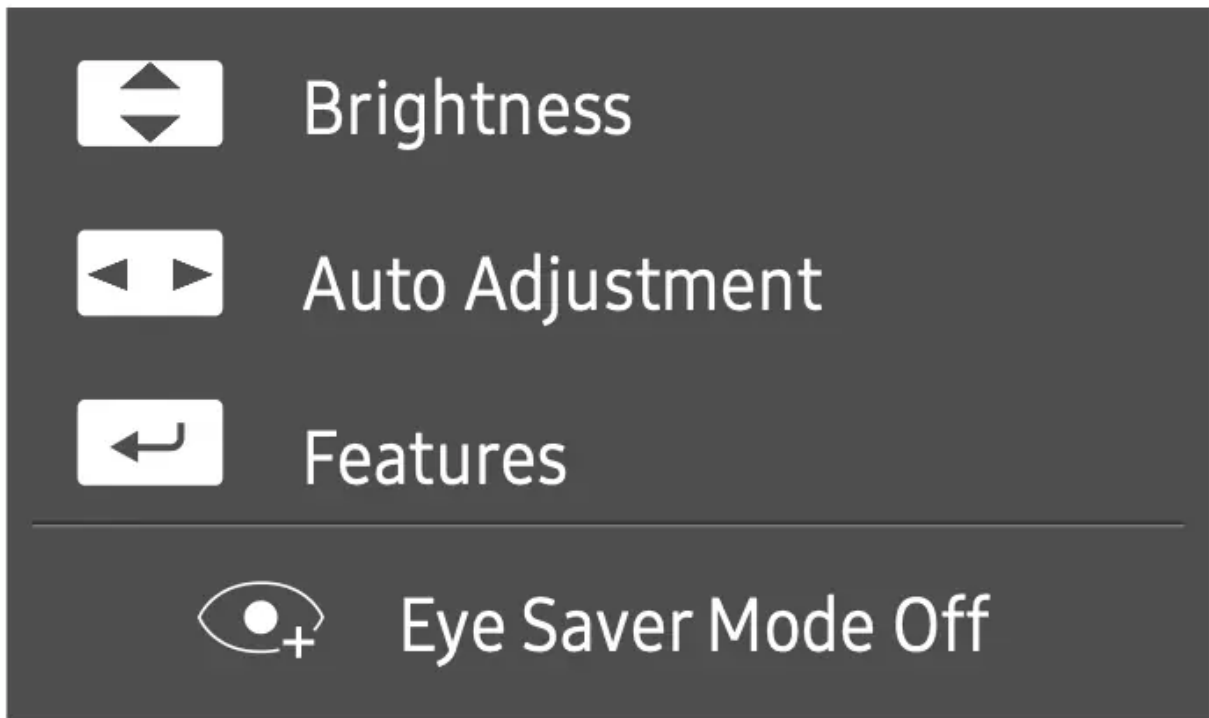

: Off

Analog mode





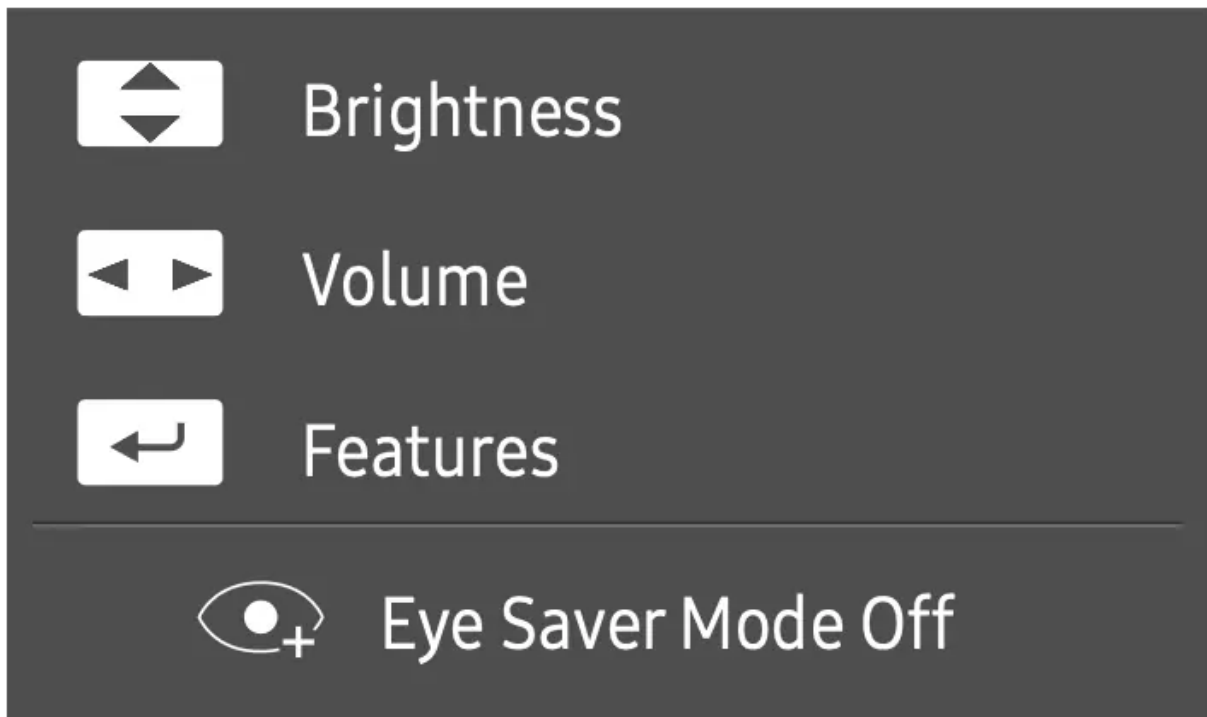

Analog mode option

-  /  : Adjust **Brightness, Contrast, Sharpness.**
-  : **Auto Adjustment.**
 - Changing the resolution in Display Properties will activate the Auto Adjustment function.
 - This function is only available in Analog mode.
-  : Display Function Key Guide.

HDMI mode



HDMI mode option







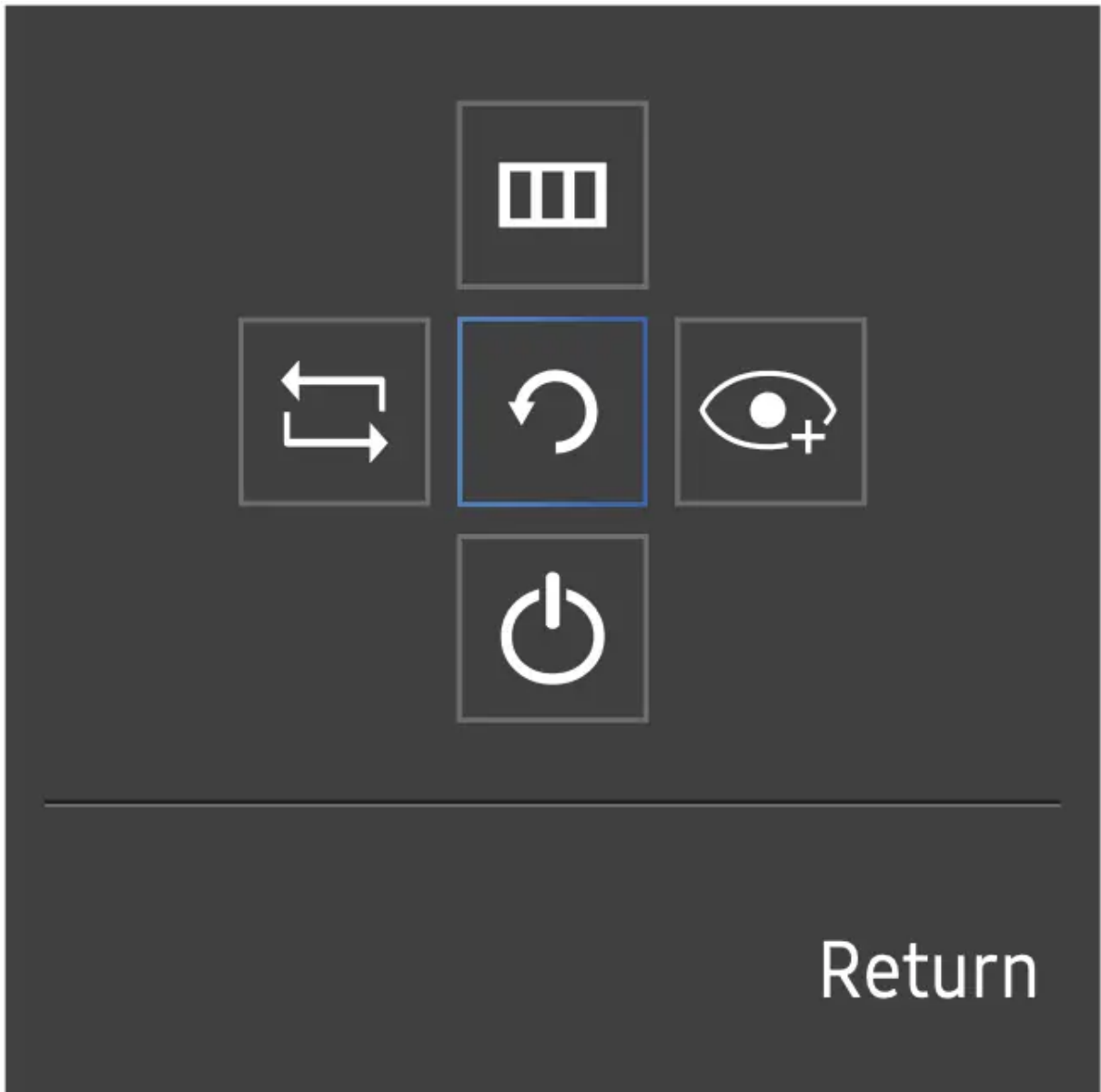

-  /  : Adjust **Brightness, Contrast, Sharpness.**
-  : Adjust **Volume, Mute.**
-  : Display Function Key Guide.

Function Key Guide

To enter the main menu or to use other items, press the JOG button to display the Function Key Guide. You can exit by pressing the JOG button again.



UP/DOWN/LEFT/RIGHT: Move to the item you want. The description for each item will appear when the focus changes. PRESS(ENTER): The selected item will be applied.

Icons	Description
	<p>Selects  to change the input signal by moving the JOG button in the Function Key Guide screen. A message will appear on the top left corner of the screen if the input signal has been changed.</p>
	<p>Selects  by moving the JOG button in the function key guide screen.</p> <p>The OSD (On Screen Display) of your Monitor's feature appears.</p> <p>OSD control lock: Maintain the current settings, or lock the OSD control to prevent unintended changes to settings.</p> <p>Enable/Disable: To lock/unlock the OSD control, press the LEFT button for 10 seconds when the main menu displayed.</p> <p>If the OSD control is locked, Brightness and Contrast can be adjusted. Eye Saver Mode is available. System > FreeSync, Power LED On is available. Information can be viewed.</p>
	<p>Selects  by moving the JOG button in the function key guide screen.</p> <p>Press to enable or disable Eye Saver Mode.</p> <p>The items below are not available if the Eye Saver Mode function is enable.</p> <ul style="list-style-type: none"> • Picture >  Bright, Brightness, Color, Game Mode • System > Eco Saving Plus
	<p>Selects  to turn the Monitor off by moving the JOG button in the function key guide screen.</p>

When the monitor displays nothing (i.e. Power saving mode or Non-signal mode), 2 direct keys for control source and power could be used as below.

JOG Button	Power saving/Non-signal mode
UP	Source Change
Down	
PRESS(ENTER) for 2 seconds	Power Off

When the monitor displays the Main menu the JOG Button could be used as below.



JOG Button	Action
UP/DOWN	Move the option
LEFT	Exit the Main menu. Close Sublist without saving value. Value decreases in the slider.
RIGHT	Move to next depth. Value increases in the slider.
PRESS(ENTER)	Move to next depth. Save the value and close Sublist.

Changing Brightness, Contrast and Sharpness settings

You can adjust Brightness, Contrast or Sharpness by moving the JOG button up or down, if no OSD menu is displayed.



The displayed image may differ depending on the model.

Brightness

- This menu is not available when **SAMSUNG MAGIC Bright** is set to **Dynamic Contrast** mode.
- This menu is not available when **Eco Saving Plus** is enabled.
- This menu is not available when **Eye Saver Mode** is enabled.

Contrast

- This menu is not available when **SAMSUNG MAGIC Bright** is in **Cinema** or **Dynamic Contrast** mode.
- This menu is not available when **Game Mode** is enabled.

Sharpness

- This menu is not available when **SAMSUNG MAGIC Bright** is in **Cinema** or **Dynamic Contrast** mode.
- This menu is not available when **Game Mode** is enabled.

Changing the Volume setting

You can adjust **Volume** by moving the JOG button left or right, if no OSD menu is displayed.

This function is only available in **HDMI** mode.







- The displayed image may differ depending on the model.
- If the audio quality of a connected input device is poor, the Auto Mute function on the product may mute the sound or cause choppy audio when applying the headphones or speakers. Set the input volume for the input device to at least 20% and control the volume using the volume control (JOG button LEFT/RIGHT) on the product.
 - What is Auto Mute?
 - The function mutes the audio to improve sound effect when there is sound noise or when the input signal is weak, usually due to a problem with the volume of an input device.
- To activate the **Mute** function, access the **Volume** control screen, then use the JOG button to move the focus down. To deactivate the **Mute** function, access the **Volume** control screen, then increase or decrease the Volume.

Types of Ports

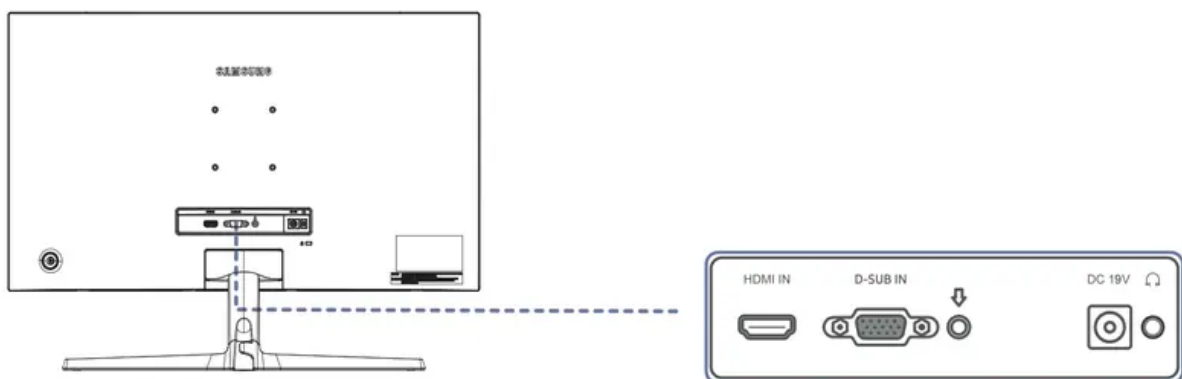
The functions available may vary depending on the product model. The color and shape of parts may differ from what is shown. Specifications are subject to change without notice to improve quality. Refer to the actual product.

C32R50*



Port	Description
	Connects to a source device using an HDMI cable or HDMI-DVI cable.
	Connect to a PC using the D-SUB cable.
	Connect to an audio output device such as headphones. — The sound could only be heard when using the HDMI to HDMI cable.
	Connects to the AC/DC adapter.

Adjusting the Product Tilt

The color and shape of parts may differ from what is shown. Specifications are subject to change without notice to improve quality.



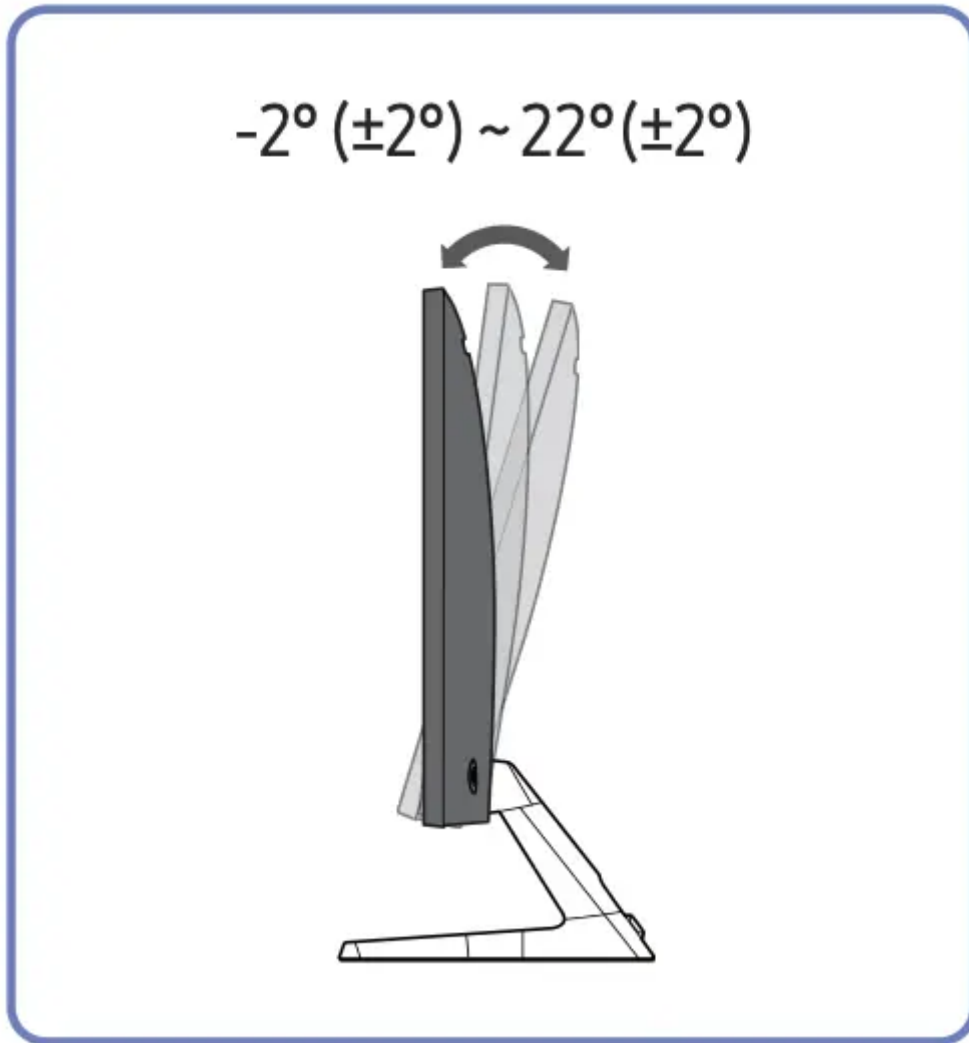

- The monitor tilt can be adjusted.
- Hold the lower part of the product and adjust the tilt carefully.

Anti-theft Lock

- An anti-theft lock allows you to use the product securely even in public places.
- The locking device shape and locking method depend on the manufacturer. Refer to the user guide provided with your anti-theft locking device for details.

To lock an anti-theft locking device:

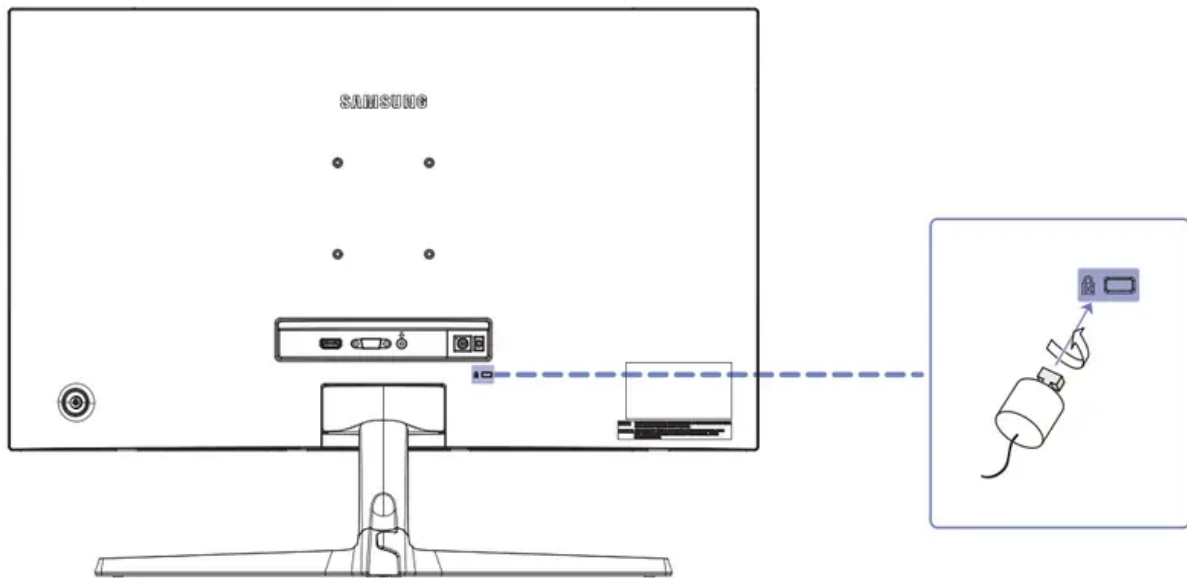

1. Fix the cable of your anti-theft locking device to a heavy object such as a desk.
 2. Put one end of the cable through the loop on the other end.
 3. Insert the locking device into the anti-theft lock slot at the back of the product.
 4. Lock the locking device.
- An anti-theft locking device can be purchased separately.
 - Refer to the user guide provided with your anti-theft locking device for details.
 - Anti-theft locking devices can be purchased at electronics retailers or online.

Precautions for moving the monitor

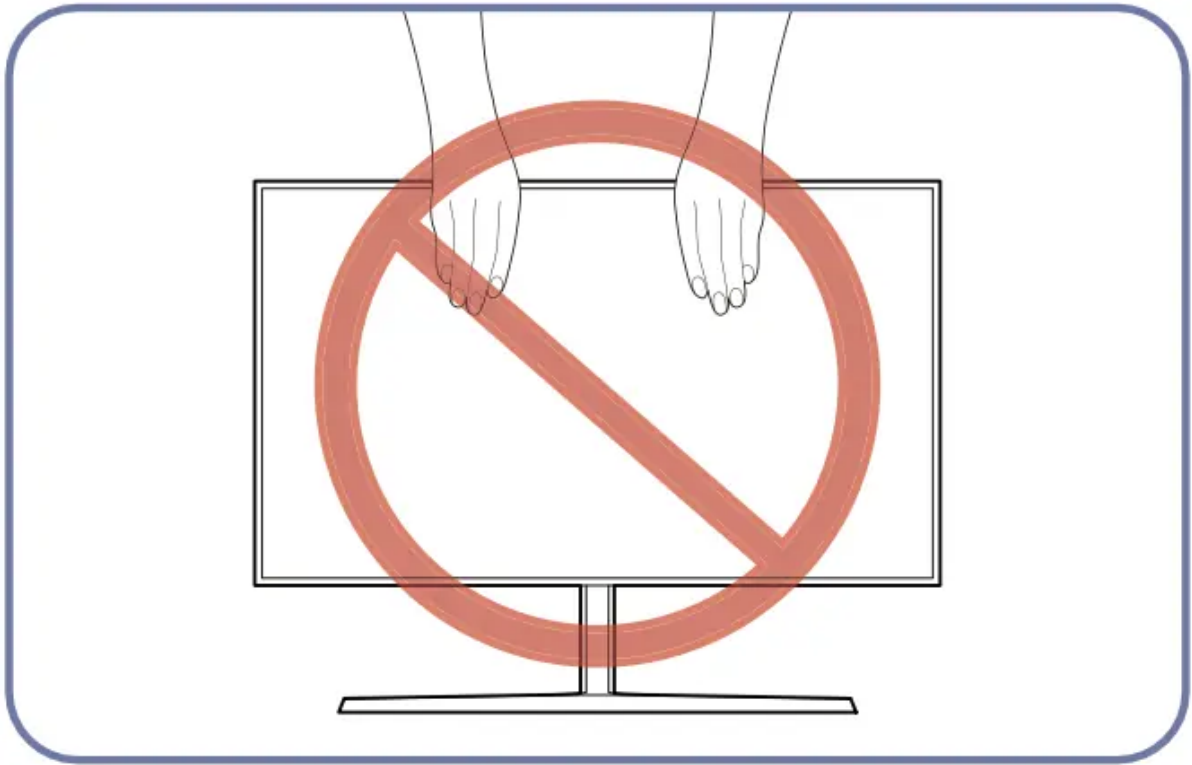

- Do not directly apply pressure on the screen.
- Do not hold the screen when moving the monitor.

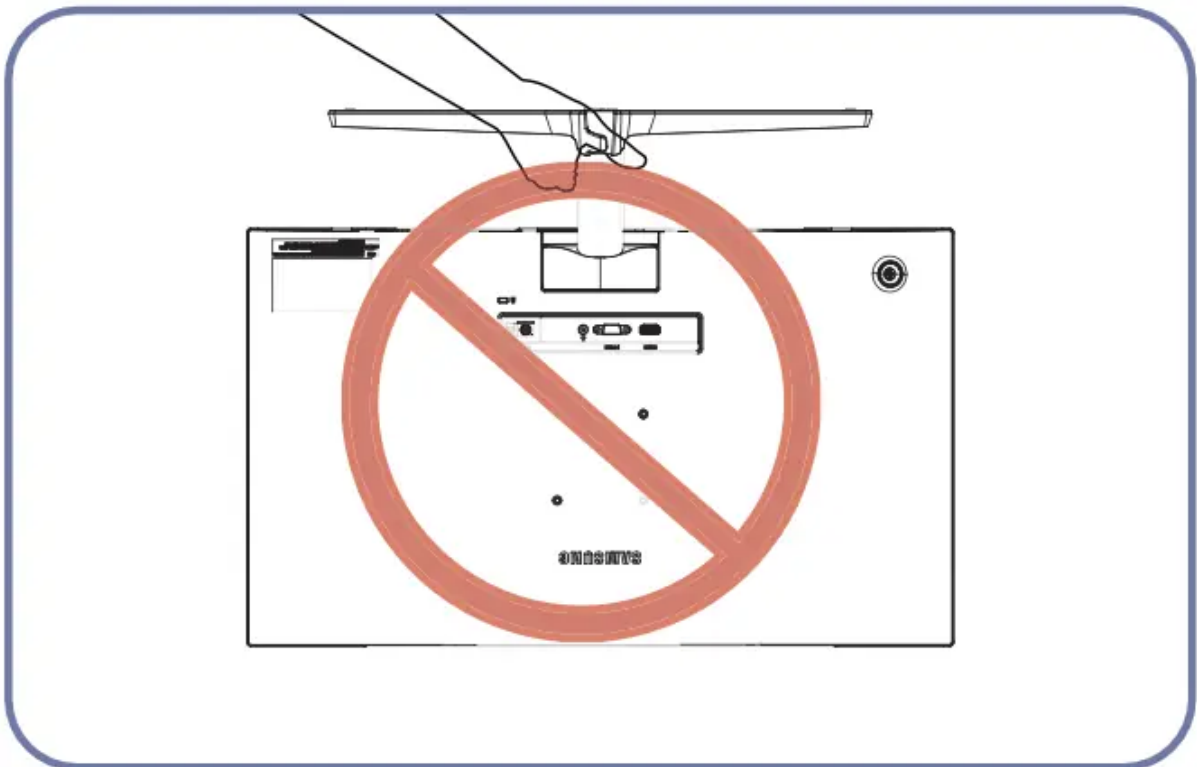

- Do not hold the product upside down only by the stand.

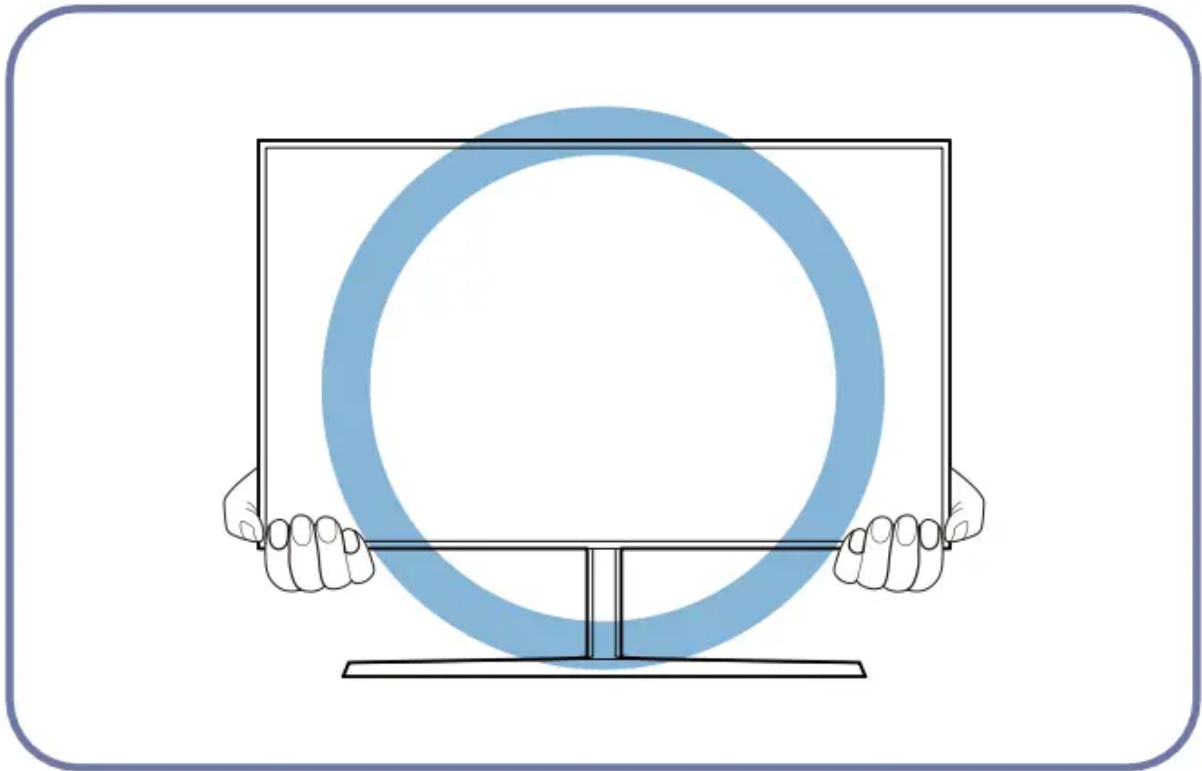

- Hold the lower corners or edges of the monitor when moving it.

Connecting and Using a Source Device

Read below before installing the monitor.

1. Check the shapes of both ends of the cables that came with the monitor, and check the shapes and positions of the matching ports on the monitor and external devices.
2. Before connecting signal cables, disconnect the power cables for the monitor and external devices from the power outlet to prevent device damage from a short circuit or overcurrent.
3. After connecting all signal cables, connect the power cables for the monitor and external devices to the power outlet.
4. Read the user manual to familiarize yourself with the monitor functions, precautions, and proper use, before using the installed monitor.

Connecting and Using a PC

Select a connection method suitable for your PC.

- Connecting parts may differ in different products.
- Provided ports may vary depending on the product.

Connection Using the HDMI or HDMI-DVI Cable

Caution: Check to make sure that the power cables for the monitor and external devices, such as computers and set-top boxes, are not connected to the power outlet.

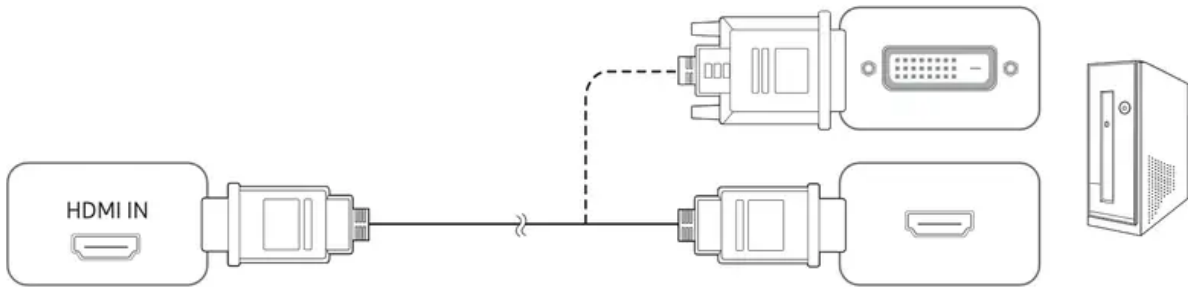

- When connecting an HDMI cable, use the cable that came with the components of the monitor. If you use an HDMI cable other than provided by Samsung, the image quality may be degraded.
- The audio function is not supported if the source device is connected using the HDMI-DVI cable.
- The maximum resolution may not be available with an HDMI-DVI cable.

Connection Using the D-SUB Cable (Analog Type)

Caution: Check to make sure that the power cables for the monitor and external devices, such as computers and set-top boxes, are not connected to the power outlet.

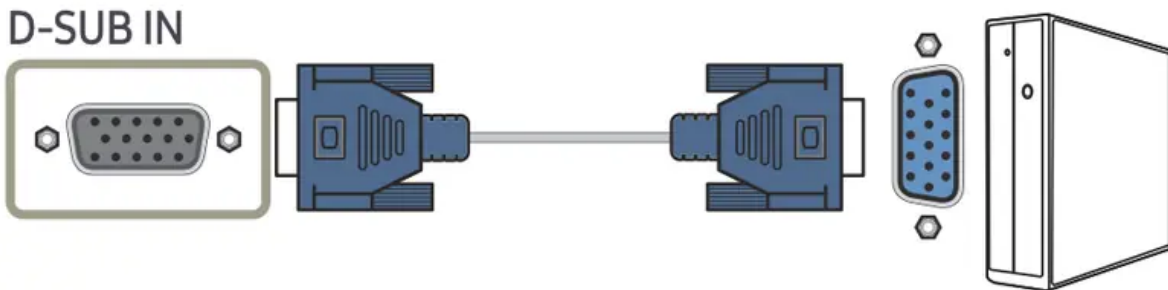

Connecting to Headphones



- Use headphones when activating sound with an HDMI-HDMI.
- The earphone jack supports only the 3 conductor tip-ring-sleeve (TRS) type.

Connecting the Power

Optional

C32R50*

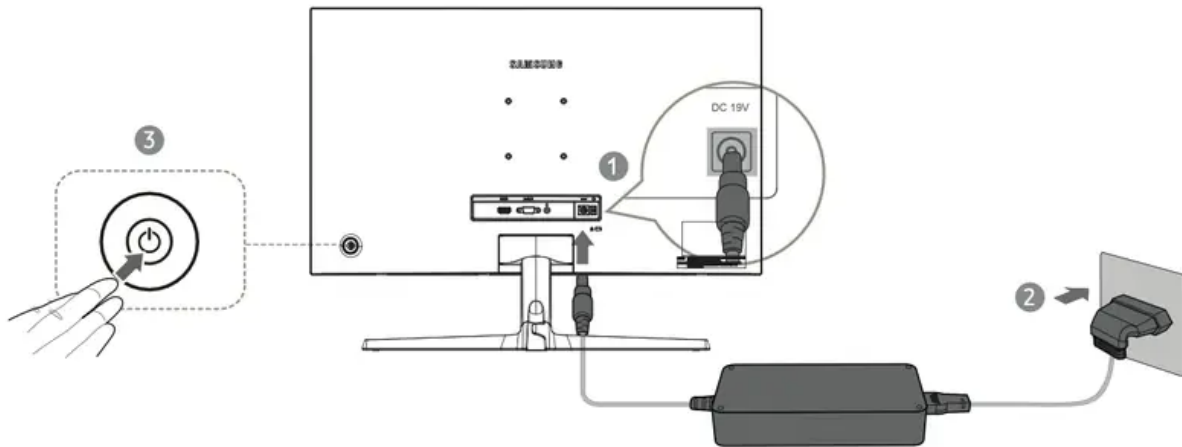

1. Connect the power cable to the AC/DC adapter. Then, connect the AC/DC adapter to the DC 19V port on the back of the product.
 2. Next, connect the power cable to the power outlet.
 3. Press the JOG button on the back of the monitor to turn it on.
- The input voltage is switched automatically.

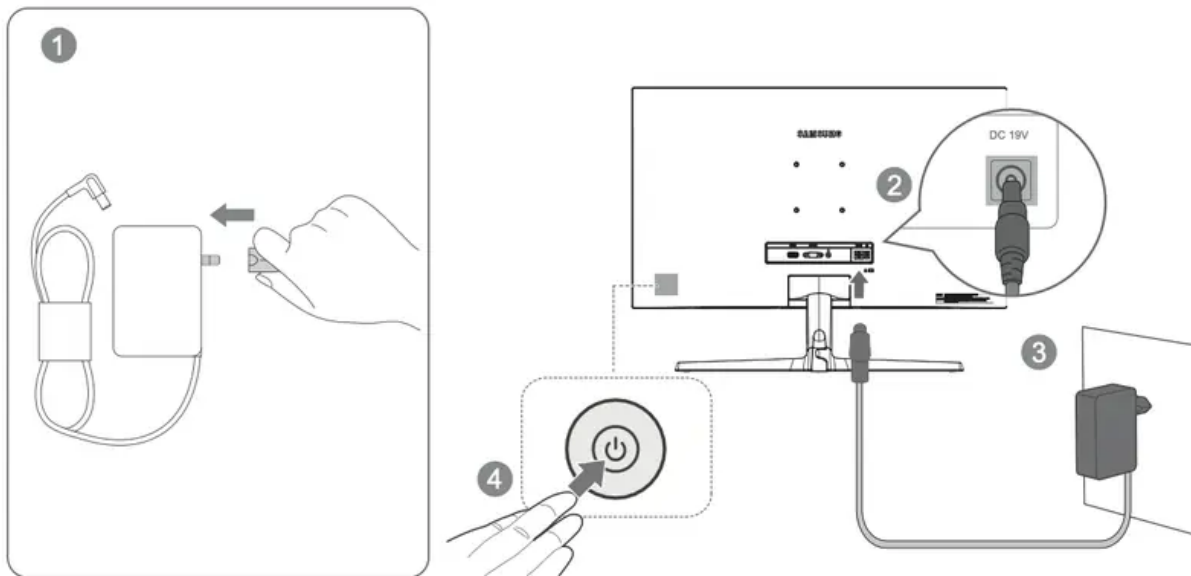

1. Connect the power plug to the AC/DC adapter. (Optional)
 2. Connect the AC/DC adapter cable to the DC 19V port on the back of the monitor.
 3. Plug the AC/DC adapter into the power outlet.
 4. Press the JOG button on the back of the monitor to turn it on.
- The input voltage is switched automatically.

Screen Setup

Configure the screen settings such as brightness.

A detailed description of each function is provided. Refer to your product for details.

SAMSUNG MAGIC Bright

This menu provides an optimum picture quality suitable for the environment where the product will be used.

- This menu is not available when **Eco Saving Plus** is enabled.
- This menu is not available when **Game Mode** is enabled.
- This menu is not available when **Eye Saver Mode** is enabled.

You can customize the brightness to suit your preferences.

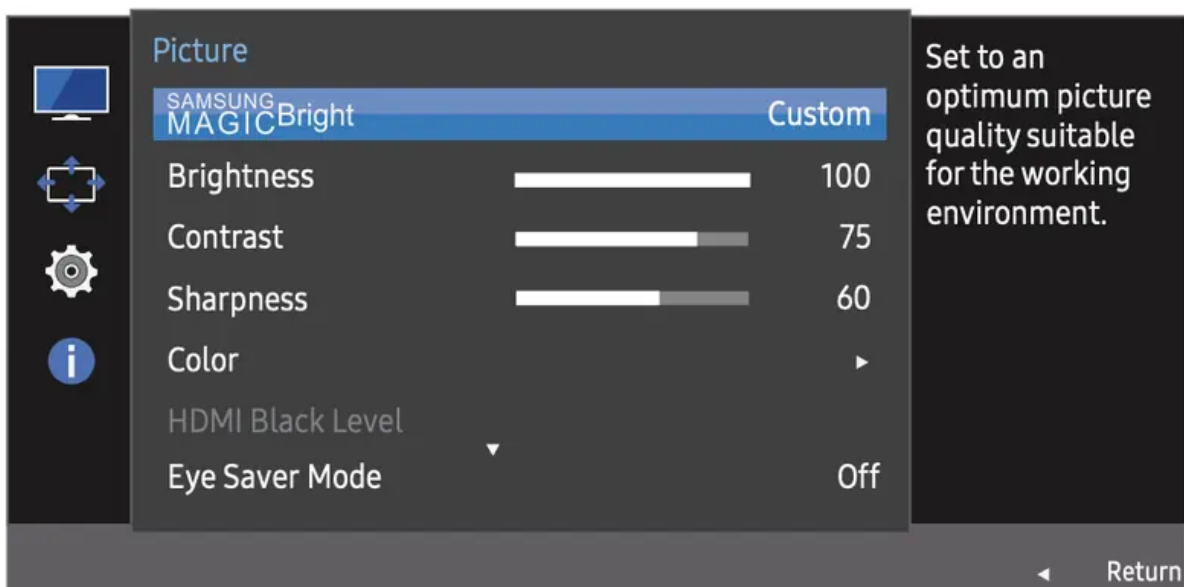

The displayed image may differ depending on the model.

In PC mode

- **Custom:** Customize the contrast and brightness as required.
- **Standard:** Obtain a picture quality suitable for editing documents or using Internet.
- **Cinema:** Obtain the brightness and sharpness of TVs suitable for enjoying video and DVD content.
- **Dynamic Contrast:** Obtain balanced brightness through automatic contrast adjustment.

In AV mode

When the external input is connected through HDMI and PC/AV Mode is set to AV, Bright has four automatic picture settings (Dynamic, Standard, Movie and Custom) that are preset at the factory.

You can activate either Dynamic, Standard, Movie or Custom. You can select Custom which automatically recalls your personalized picture settings.

- **Dynamic:** Select this mode to view a sharper image than in Standard mode.
- **Standard:** Select this mode when the surroundings are bright. This also provides a sharp image.
- **Movie:** Select this mode when the surroundings are dark. This will save power and reduce eye fatigue.
- **Custom:** Select this mode when you want to adjust the image according to your preferences.

Brightness

You can adjust the general brightness of the picture. (Range: 0~100) A higher value will make the picture appear brighter.

- This menu is not available when **SAMSUNG MAGIC Bright** is set to **Dynamic Contrast** mode.
- This menu is not available when **Eco Saving Plus** is enabled.
- This menu is not available when **Eye Saver Mode** is enabled.

Contrast

Adjust the contrast between the objects and background. (Range: 0~100)

A higher value will increase the contrast to make the object appear clearer.

- This option is not available when **SAMSUNG MAGIC Bright** is in **Cinema** or **Dynamic Contrast** mode.
- This menu is not available when **Game Mode** is enabled.

Sharpness

Make the outline of objects more clear or blurry. (Range: 0~100)

A higher value will make the outline of objects clearer.

- This option is not available when **SAMSUNG MAGIC Bright** is in **Cinema** or **Dynamic Contrast** mode.
- This menu is not available when **Game Mode** is enabled.

Color

Adjust the tint of the screen.

This menu is not available when **SAMSUNG MAGIC Bright** is set to **Cinema** or **Dynamic Contrast** mode.

This menu is not available when **Game Mode** is enabled.

This menu is not available when **Eye Saver Mode** is enabled.

- **Red:** Adjust the red saturation level. Values closer to 100 mean greater intensity for the color.
- **Green:** Adjust the green saturation level. Values closer to 100 mean greater intensity for the color.
- **Blue:** Adjust the blue saturation level. Values closer to 100 mean greater intensity for the color.
- **Color Tone:** Select a color tone that best suits your viewing needs.
 - **Cool 2:** Set the color temperature to be cooler than Cool 1.
 - **Cool 1:** Set the color temperature to be cooler than Normal mode.
 - **Normal:** Display the standard color tone.
 - **Warm 1:** Set the color temperature to be warmer than Normal mode.
 - **Warm 2:** Set the color temperature to be warmer than Warm 1.
 - **Custom:** Customize the color tone.

When the external input is connected through HDMI/VGA and PC/AV Mode is set to AV, Color Tone has four color temperature settings (Cool, Normal, Warm and Custom).

- **Gamma:** Adjust the middle level of luminance.
 - **Mode 1 / Mode 2 / Mode 3**

HDMI Black Level

If a DVD player or set-top box is connected to the product via HDMI, image quality degradation (contrast/ color degradation, black level, etc.) may occur, depending on the connected source device. In such case, **HDMI Black Level** can be used to adjust the image quality.

If this is the case, correct the degraded picture quality using HDMI Black Level

This function is only available in **HDMI** mode.

- **Normal:** Select this mode when there is no contrast ratio degradation.
- **Low:** Select this mode to reduce the black level and increase the white level when there is a contrast ratio degradation.

HDMI Black Level may not be compatible with some source devices.

The **HDMI Black Level** feature is only activated at a certain **AV** resolution, such as 720P and 1080P.

Eye Saver Mode

Set to an optimum picture quality suitable for eye relaxation.

TÜV Rheinland “Low Blue Light Content” is a certification for products which meet requirements for lower blue light levels. When **Eye Saver Mode** is 'On', the blue light that wavelength is around 400nm will decrease, and it will provide an optimum picture quality suitable for eye relaxation. At the same time, the blue light level is lower than in the default settings, and it was tested by TÜV Rheinland and certified as it met the requirements of TÜV Rheinland “Low Blue Light Content” standards.

Game Mode

Configure the product screen settings for game mode.

Use this feature when playing games on a PC or when a game console such as PlayStation™ or Xbox™ is connected.

- This menu is not available when **Eye Saver Mode** is enabled.
- When the monitor turns off, enters power-saving mode or changes input sources, **Game Mode** turns **Off** even if it is set to **On**.
- If you want to keep **Game Mode** enabled all the time, select **Always On**.

Response Time

Accelerate the panel response rate to make video appear more vivid and natural.

It is best to set **Response Time** to **Standard** or **Faster** when you are not viewing a movie.

Picture Size

Change the picture size.

This option is not available when **FreeSync** is enabled.

In PC mode

- **Auto:** Display the picture according to the aspect ratio of the input source.
- **Wide:** Display the picture in full screen regardless of the aspect ratio of the input source.

In AV mode

- **4:3:** Display the picture with an aspect ratio of 4:3. Suitable for videos and standard broadcasts.
- **16:9:** Display the picture with an aspect ratio of 16:9.
- **Screen Fit:** Display the picture with the original aspect ratio without cutting off.

The function may not be supported depending on the ports provided with the product. Changing the screen size is available when the following conditions are satisfied.

A digital output device is connected using the HDMI cable.

The input signal is 480p, 576p, 720p, or 1080p and monitor can display normally (Not every model can support all of these signals.).

This can only be set when the external input is connected through HDMI and **PC/AV Mode** is set to **AV**.

Screen Adjustment

This menu is available in **Analog** mode only.

This menu is only available when **Picture Size** is set to **Screen Fit** in **AV** Mode.

When a 480P or 576P or 720P or 1080P signal is input in **AV** mode and the monitor can display normally, select Screen Fit to adjust horizontal position in 0-6 levels.

Configuring H-Position & V-Position

H-Position: Move the screen to the left or right.

V-Position: Move the screen up or down.

Configuring Coarse

Adjust the screen frequency.

- This menu is available in **Analog** mode only.

Configuring Fine

Fine-adjust the screen to obtain a vivid picture.

- This menu is available in **Analog** mode only.
- The functions available may vary depending on the product model. The color and shape of parts may differ from what is shown. Specifications are subject to change without notice to improve quality.

Adjusting OSD (On Screen Display) settings

Transparency

Set the transparency for the menu windows.

Position

H-position: Move the menu position to left or right.

V-position: Move the menu position up or down.

Language

Set the menu language.

- A change to the language setting will only be applied to the onscreen menu display.
- It will not be applied to other functions on your PC.

Display Time

Set the on-screen display (OSD) menu to automatically disappear if the menu is not used for a specified period of time.

Display Time can be used to specify the time after which you want the OSD menu to disappear.

Troubleshooting Guide

Requirements Before Contacting Samsung Customer Service Center

Before calling Samsung Customer Service Center, test your product as follows. If the problem persists, contact Samsung Customer Service Center.

Testing the Product

Check if your product is operating normally by using the product test function.

If the screen is turned off and the power indicator blinks even though the product is properly connected to a PC, perform a self-diagnosis test.

1. Power off both the PC and product.
2. Disconnect the cables from the product.
3. Power on the product.
4. If the message Check Signal Cable appears, the product is working normally.

If the screen remains blank, check the PC system, video controller and cable.

Checking the Resolution and Frequency

For a mode that exceeds the supported resolution(refer to Standard Signal Mode Table), the message Not Optimum Mode will appear for a short time.

The displayed resolution may vary, depending on the computer system settings and cables.

Check the following.

Installation issue (PC mode)

- The screen keeps switching on and off.
 - Check the cable connection between the product and PC, and ensure the connectors are locked.

- Blank spaces are found on all four sides of the screen when an HDMI or HDMI-DVI cable is connected to the product and PC.
 - The blank spaces found on the screen have nothing to do with the product.
 - Blank spaces on the screen are caused by the PC or graphics card. To resolve the problem, adjust the screen size in the HDMI or DVI settings for the graphics card.
 - If the graphics card settings menu does not have an option to adjust the screen size, update the graphics card driver to the latest version.
 - (Please contact the graphics card or computer manufacturer for further details about how to adjust the screen settings.)

Screen issue

- The power LED is off. The screen will not switch on.
 - Check that the power cable is connected properly.
- The message **Check Signal Cable** appears.
 - Check that the cable is properly connected to the product.
 - Check that the device connected to the product is powered on.

Not Optimum Mode is displayed.

- This message appears when the signal from the graphics card exceeds the maximum resolution or frequency for the product.
- Change the maximum resolution and frequency to suit the product performance, referring to Standard Signal Mode Table (P.42).
- The images on the screen look distorted.
 - Check the cable connection to the product.
- The screen is not clear. The screen is blurry.
 - Remove any accessories (video extension cable, etc.) and try again.
 - Set the resolution and frequency to the recommended level.
- The screen appears unstable and shaky. There are shadows or ghost images left on the screen.
 - Check that the resolution and frequency for the PC are within the range of resolution and frequency compatible with the product. Next, if required, change the settings, referring to Standard Signal Mode Table (P.42) in this manual and the **Information** menu on the product.
- The screen is too bright. The screen is too dark.
 - Adjust **Brightness** and **Contrast**.

- Screen color is inconsistent.
 - Change the **Color** settings.
- The colors on the screen have a shadow and are distorted.
 - Change the **Color** settings.
- White does not really look white.
 - Change the **Color** settings.
- There is no image on the screen and the power LED blinks every 0.5 to 1 second.
 - The product is operating in power-saving mode.
 - Press any key on the keyboard or move the mouse to return to normal operating mode.
- Text is blurry.
 - If using a Windows OS (e.g. Windows 7, Windows 8, Windows 8.1 or Windows 10): Go to **Control Panel > Fonts > Adjust ClearType text and change Turn on ClearType.**
- Video playback is choppy.
 - Playback of high-definition large video files can be choppy. This may be because the video player is not optimized for the computer resource.
 - Try playing the file on another video player.

Sound issue

- There is no sound.
 - Check the connection of the audio cable or adjust the volume.
 - Check the volume.
- The volume is too low.
 - Adjust the volume.
 - If the volume is still low after turning it up to the maximum level, adjust the volume on your PC sound card or software program.
- Video is available but there is no sound.
 - Sound cannot be heard if a HDMI-DVI cable is used to connect the input device. Connect the device using an HDMI cable.

Source device issue

- A beeping sound is heard when my PC is booting.
 - If a beeping sound is heard when your PC is booting, have your PC serviced.

Q&A

Refer to the user manual for your PC or graphics card for further instructions on adjustment.

How can I change the frequency?

Set the frequency on your graphics card.

- **Windows 7:** Go to Control Panel > Appearance and Personalization > Display > Screen Resolution > Advanced settings > Monitor, and adjust Refresh rate under Monitor settings.
- **Windows 8 (Windows 8.1):** Go to Settings > Control Panel > Appearance and Personalization > Display > Screen Resolution > Advanced settings > Monitor, and adjust Refresh rate under Monitor settings.
- **Windows 10:** Go to Settings > System > Display > Advanced display settings > Display adapter properties > Monitor, and adjust Screen refresh rate under Monitor settings.

How can I change the resolution?

- **Windows 7:** Go to Control Panel > Appearance and Personalization > Display > Adjust Resolution, and adjust the resolution.
- **Windows 8 (Windows 8.1):** Go to Settings > Control Panel > Appearance and Personalization > Display > Adjust Resolution, and adjust the resolution.
- **Windows 10:** Go to Settings > System > Display > Advanced display settings, and adjust the resolution.

How do I set power-saving mode?

- **Windows 7:** Set power-saving mode in Control Panel > Appearance and Personalization > Personalize > Screen Saver Settings > Power options or BIOS SETUP on the PC.
- **Windows 8 (Windows 8.1):** Set power-saving mode in Settings Control Panel > Appearance and Personalization > Personalize > Screen Saver Settings > Power options or BIOS SETUP on the PC.
- **Windows 10:** Set power-saving mode in Settings > Personalization > Lock screen > Screen timeout settings > Power & sleep or BIOS SETUP on the PC.

Warning

This content is compiled from multiple sources and is provided for reference purposes only. It may not be complete or fully applicable to all situations. If you are unable to resolve your issue, please contact the product manufacturer or an authorized service provider for official support.