

Operating your French Door Refrigerator

USING THE CONTROL PANEL

RF28HFEDB* / RF28HFPDB*

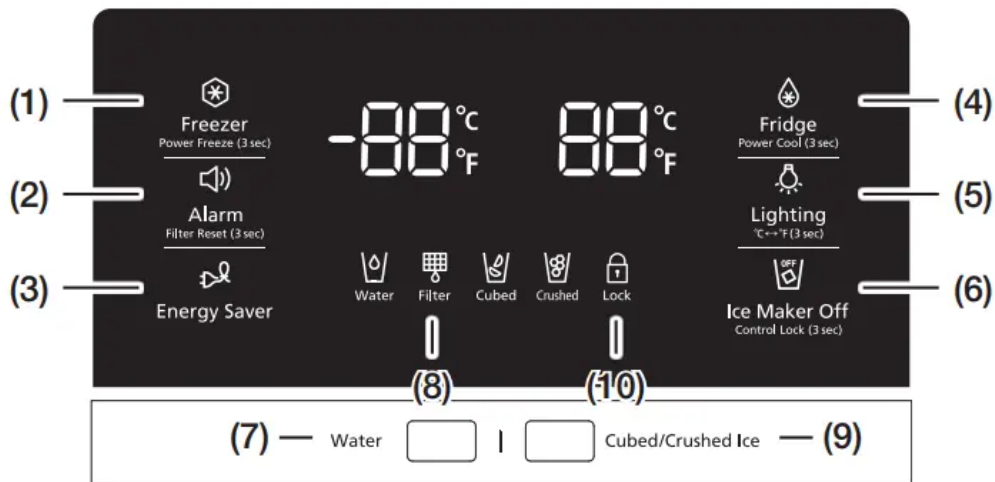

**(1) Freezer /
Power Freeze
(3sec)**



The Freezer button serves two purposes:

- To set the Freezer to your desired temperature.
- To turn the Power Freeze function on and off.

1. To set the Freezer temperature, touch the Freezer button.

You can set the temperature between 5 °F (-15 °C) and -8 °F (-23 °C).

2. Power Freeze function

Touch and hold this button for 3 seconds to decrease the time needed to freeze products in the Freezer.

It can be helpful if you need to quickly freeze easily spoiled items or if the temperature in the freezer has warmed dramatically

(For example, if the door was left open.) When you use this function, the energy consumption of the refrigerator will increase

Remember to turn it off when you don't need it and return the freezer to your original temperature setting.

If you need to freeze a large amount of food, activate the Power Freeze function at least 24 hours before you put the food into the freezer.

**(2) Alarm / Filter
Reset (3sec)**



The Alarm button serves two purposes:

- To turn the door open alarm on and off
- To reset the water filter life indicator.

1. Door Alarm Function

If the door alarm is set to On, an alarm beeps if any refrigerator door is left open for more than three minutes.

The beeping stops when you close the door



The door alarm function is pre-set to On in the factory.

You can turn it off by pressing and then releasing the Alarm button.

You can turn it back on in the same fashion.

The icon lights up when the function is on. When the Door Alarm function is on and the alarm sound is triggered, the Door Alarm Icon will blink while the alarm sounds.

2. Water Filter Life Indicator Function

	<p>After you replace the water filter, touch and hold this button for 3 seconds to reset the water filter life indicator.</p> <p>When you reset the water filter life indicator, the Filter icon on the panel turns Off.</p> <p>The Filter icon will turn red to let you know it is time to change the water filter after six months (about 300 gallons).</p> <p>Some areas have large amounts of lime in their water, which causes the water filter to clog more quickly.</p> <p>If this is the case in your area, you will have to change the filter more frequently than every six months.</p>
<p>(3) Energy Saver</p> 	<p>Touching this button turns Energy Saver mode on and off.</p> <p>When you turn Energy Saver on, the Energy Saver icon lights.</p> <p>Turn Energy Saver off and the icon goes off.</p> <p>The Energy Saver function automatically turns on when power is supplied to the refrigerator.</p> <p>If condensation or water drops appear on the doors, turn the Energy Saver mode off.</p>
<p>(4) Fridge / Power Cool (3sec)</p> 	<p>The Fridge button serves two purposes:</p> <ul style="list-style-type: none"> - To set the Fridge to your desired temperature. - To turn the Power Cool function on and off. <p>1. To set the Fridge temperature, press the Fridge button.</p> <p>You can set the temperature between 44 °F (7 °C) and 34 °F (1 °C).</p> <p>2. Power Cool function</p> <p>Touch and hold this button for 3 seconds to decrease the time needed to cool products in the Refrigerator.</p> <p>It can be helpful if you need to quickly cool easily spoiled items or if the temperature in the fridge has warmed dramatically. (for example, if the door was left open)</p>
<p>(5) Lighting / °C ↔ °F (3sec)</p>	<p>The Lighting button serves two purposes:</p> <ul style="list-style-type: none"> - To turn the dispenser light on and off - To switch the temperature units between °C and °F



1. Light Function

Touching the Lighting button turns on the Dispenser LED lamp in continuous mode so that it stays on continuously. The button also lights up.

If you want the Dispenser lamp to come on only when some one uses the dispenser, press the Lighting button to turn the continuous mode off.

2. To switch the temperature units between °C and °F.

Touch and hold this button for 3 seconds to select the temperature display you want. Each time you press and hold the button, the °C and °F temperature modes alternate and the °C or °F icon lights up, indicating your selection.



(6), (11) Ice Maker Off



If you don't want to make more ice, touch the Ice Maker Off button. The icon will light up and the Ice-Maker stops making ice.

We recommend you to stop ice making if the following occur:

- There is enough ice in the ice bucket.
- You want to save water and energy.
- Water is not being supplied to the refrigerator.

If the ice maker function is ON, and the water Line is not connected, there will be a water valve noise from the back of the unit. Press the Ice Maker Off (Control Lock (3sec)) button for less than 3 seconds until the Ice Off Indicator ( ) illuminates.

(7) Water



Touch this button to dispense water. This mode can not be used with the Ice Type mode simultaneously.



Water mode shuts off when you touch the Cubed / Crushed Ice button.

(8) Filter



Water filter usage

This icon lights up when you need to change the filter, usually after the refrigerator has dispensed about 300 gallons of water (after about 6 months). The icon will blink red for several seconds when you open or close the door.

	<p>After you install the new water filter, reset the filter indicator by touching and holding the Hold 3sec for Filter Reset button for 3 seconds.</p> <ul style="list-style-type: none"> - If water is not dispensing or dispensing slowly, you need to replace the water filter because the water filter is clogged. - Some areas have large amounts of lime in their water, which causes the water filter to clog more quickly.
<p>(9) Ice Type</p> <div style="text-align: center;">  (Cubed) </div> <div style="text-align: center;">  (Crushed) </div>	<p>Touch this button to select your desired ice type.</p> <p>Cubed and crushed ice modes alternate when you press the button.</p> <p>This mode can not be used with the Water mode simultaneously.</p>
<p>(10) Ice Maker Off / Control Lock (3sec)</p> <div style="text-align: center;">  </div>	<p>The Ice Maker Off button serves two purposes:</p> <ul style="list-style-type: none"> - To turn the Ice maker on and off - To turn the Control Lock Function on and off. <ol style="list-style-type: none"> 1. Ice Off Function <p>If you don't want to make more ice, press the Ice Maker Off button.</p> 2. Control Lock Function <p>Touch and hold this button for 3 seconds to lock the display and the dispenser buttons so the buttons can not be used. When Control Lock is on, the refrigerator does not dispense ice or water, even if the Dispenser Lever is pressed.</p> <p>The Control Lock icon lights up to indicate you've activated the Control Lock function. Press 3 seconds to unlock.</p>

<p>Cooling Off Mode</p> 	<p>Cooling Off mode (also called Shop mode), is designed for use by retailers when they are displaying refrigerators on the shop floor.</p> <p>In Cooling Off mode, the refrigerator's fan motor and lights work normally, but the compressors do not run, and the refrigerator and freezer do not get cold. To start Cooling Off mode, touch and hold the Freezer, Fridge and Alarm buttons for 5 seconds during normal operation. The refrigerator chime sounds and the temperature display flashes OFF.</p> <p>To cancel Cooling Off mode, touch and hold the Freezer, Fridge and Alarm buttons again for 5 seconds.</p>
--	---

CONTROLLING THE TEMPERATURE

Basic temperature of Freezer and fridge compartments

The basic and recommended temperatures of the Freezer and Fridge compartments are 0 °F and 37 °F (or -18 °C and 3 °C) respectively.

If the temperature of the Freezer and Fridge compartments are too high or low, adjust the temperature manually.

Controlling the Freezer temperature

RF28HFEDB* / RF28HFPDB*

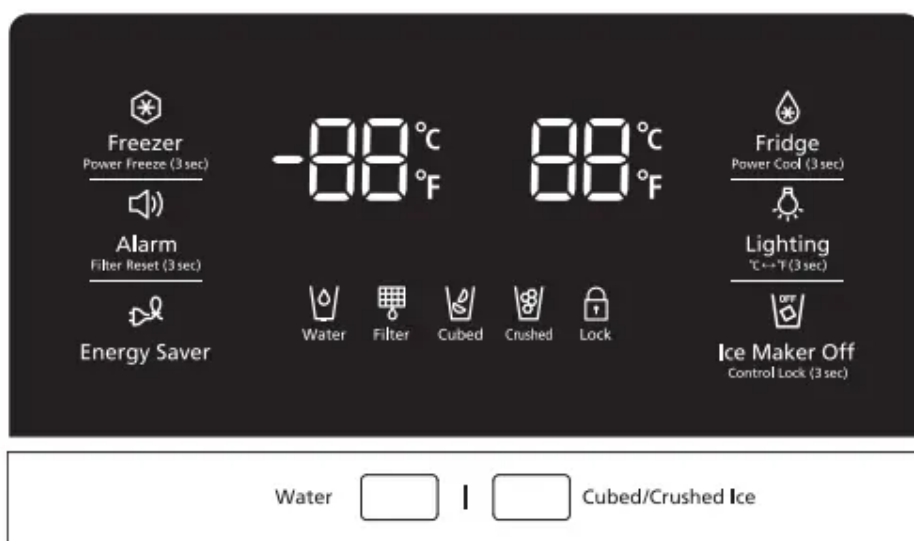

RF28HFEDT*

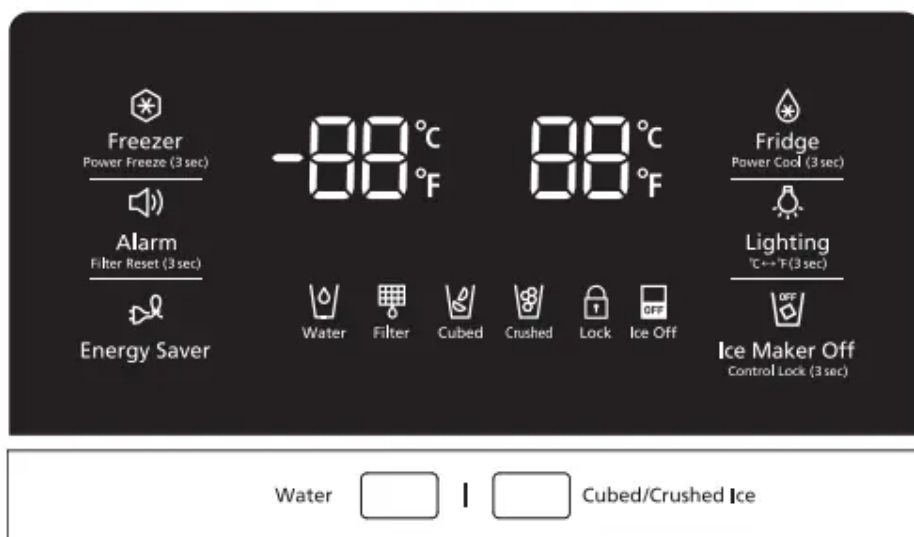

Recommend Temp (Freezer) : 0 °F (or -18 °C)

The Freezer temperature can be set between -8 °F and 5 °F (or between -23 °C and -15 °C) to suit your particular needs.

Press the Freezer button repeatedly until the desired temperature is shown in the temperature display.

The temperature will change by 1 °F (or 1 °C) with each press. See below.

Fahrenheit : 0 °F → -1 °F → -2 °F → -3 °F → -4 °F → -5 °F → -6 °F → -7 °F → -8 °F → 5 °F → 4 °F → 3 °F → 2 °F → 1 °F → 0 °F.

Centigrade : -18 °C → -19 °C → -20 °C → -21 °C → -22 °C → -23 °C → -15 °C → -16 °C → -17 °C → -18 °C.

Keep in mind that foods such as ice cream may/ melt at 4 °F (or -15.5 °C).

The temperature display will move sequentially from -8 °F to 5 °F (or from -23 °C to -15 °C).

Controlling the fridge temperature

RF28HFEDB* / RF28HFPDB*

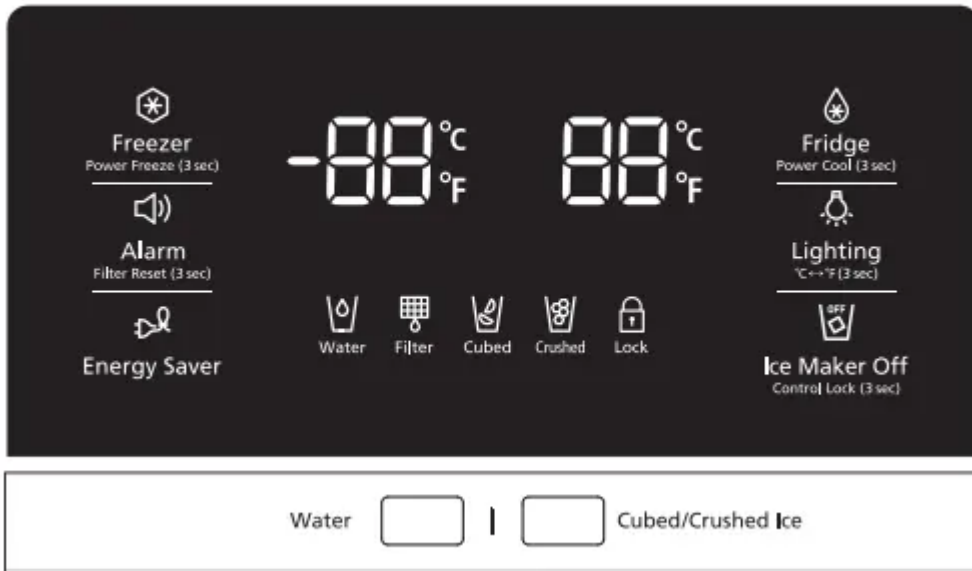

RF28HFEDT*

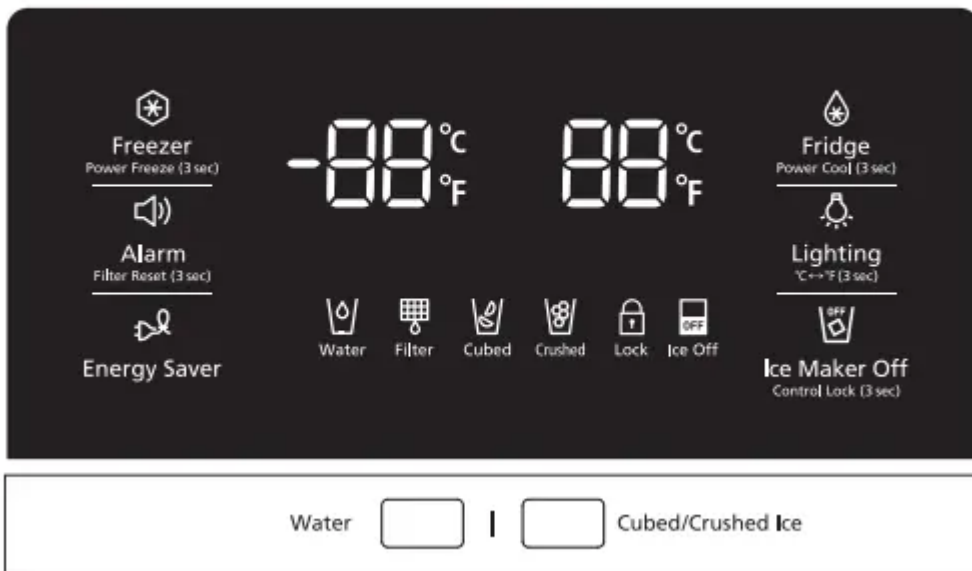

Recommend Temp (Fridge) : 37 °F (or 3 °C)

The fridge temperature can be set between 34 °F and 44 °F (or between 1 °C and 7 °C) to suit your particular needs.

Press the Fridge button repeatedly until the desired temperature is shown in the temperature display. The temperature will change by 1 °F (or 1 °C) with each press. See below.



Fahrenheit : 37 °F → 36 °F → 35 °F → 34 °F → 44 °F → 43 °F → 42 °F → 41 °F → 40 °F → 39 °F → 38 °F → 37 °F.

Centigrade : 3 °C → 2 °C → 1 °C → 7 °C → 6 °C → 5 °C → 4 °C → 3 °C.

The temperature control process for the Fridge works just like the Freezer process.

Press the Fridge button to set your desired temperature.

After a few seconds, the Fridge will begin adjusting towards the newly set temperature.

This will be reflected in the digital display.

USING THE COLD WATER DISPENSER

Push the appropriate ice type button to select what you want dispensed.

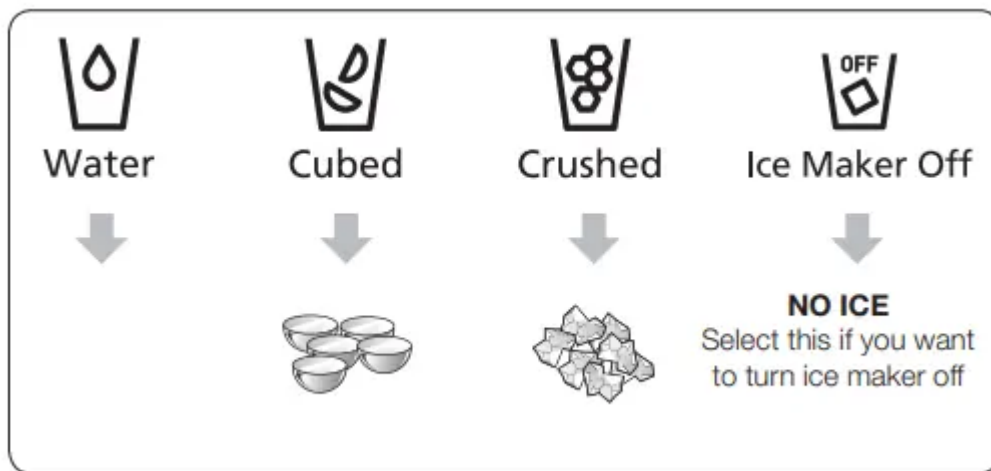

Using the ice Dispenser

Place a glass underneath the ice dispenser and push gently against the dispenser lever with your glass. Make sure the glass is in line with the dispenser to prevent the ice from bouncing out.



- To select water, press the water button on the display, and then press the dispenser lever.
- To select Ice, press the ICE type button of your choice on the display, and then press the dispenser lever.
- If you have selected cubed ice, when you press the lever, the dispenser may dispense a small amount of crushed ice first.

- If ice doesn't come out, pull out the ice bucket and press the test button located on the right side of ice maker.

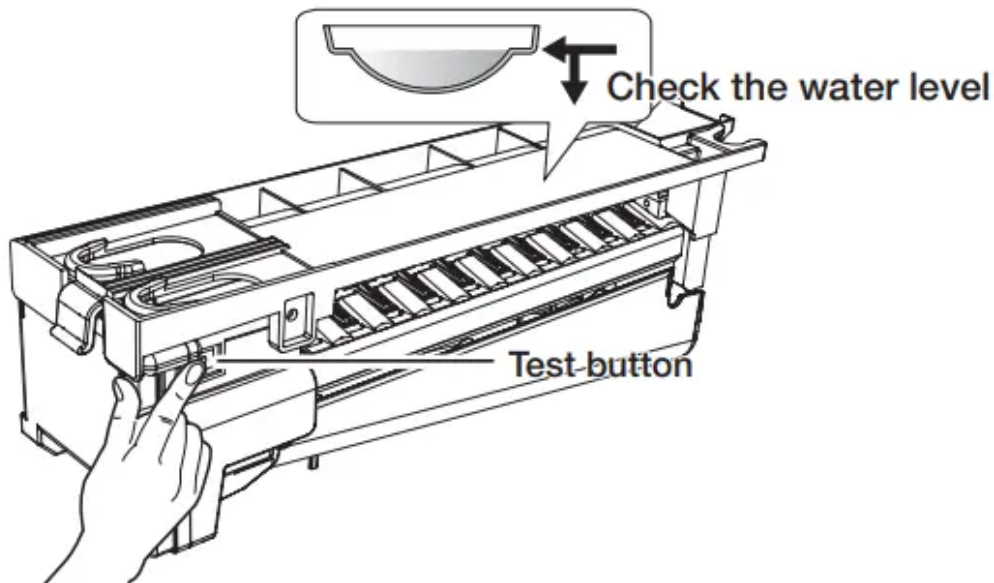

- Do not press the test button continuously when the tray is filled with ice or water. Water may overflow or ice may jam the bucket.
- When you press the Test button, you will hear the refrigerator chime (ding-dong). When the chime sounds, release the Test button.
- The chime sounds automatically again to let you know the ice maker is working well.
- Replace the ice bucket.

Ice Making

To fill the ice bucket to maximum capacity after installation, follow these steps:

1. Allow your refrigerator to operate and cool down for 24 hours (or 1 full day).
 - Waiting 24 hours will allow your ice maker to cool properly.
2. Dispense 4 to 6 ice cubes into a glass.
3. After 8, and then 16 hours, dispense a full glass of ice.

If There is a Power Failure

If a power failure occurs, ice cubes may melt, and then freeze together when the power comes back on, preventing the dispenser from working properly.

To prevent this problem, after a power failure, pull out the ice bucket and discard the residual ice or water.

After you dump the ice from the ice bucket, you should press the dispenser lever once with the 'Water' or 'Ice Type' function ON.

The ice maker will make new ice faster after you return the ice bucket to the refrigerator.

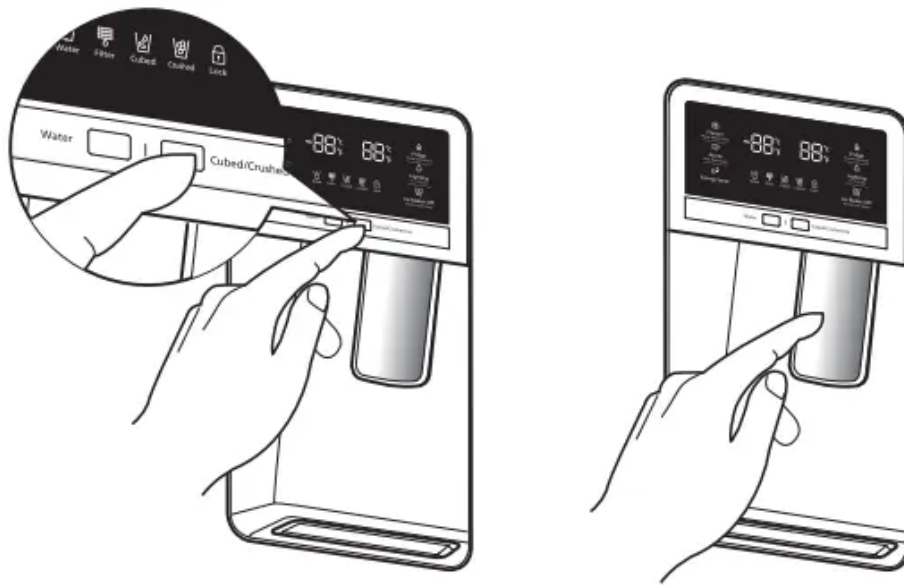

Using the ice off Function

When you select the Ice Off mode, remove all ice cubes from the bucket.

If you leave the ice cubes in the bucket, the ice cubes may clump together, making it difficult to remove them.

To remove the ice bucket safely and avoid injury, hold the bottom of the bucket with one hand and the side of the bucket with the other. Then, lift up on the ice bucket, and pull it straight out.

To put the ice bucket back in, push it firmly straight back.

If the bucket does not fit, turn the helix 90 degree (see the last illustration on the right, below) and try again.

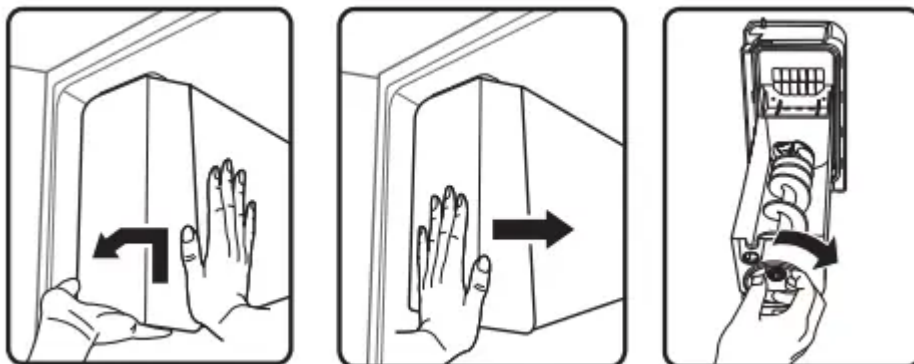

Going on vacation...

If you are going on a long vacation or business trip and won't use the water or ice dispensers for a long time:

- Close the water valve. Otherwise, water leakage may occur.
- Remove all food and ice in the ice bucket.
- Unplug the refrigerator.
- Wipe excess moisture from inside and leave the doors open. Otherwise, odor and mold may develop.

Ice Maker Do's and Don'ts

- Do not put your fingers, hands or any other unsuitable objects in the chute or ice-maker bucket.
 - It may result in personal injury or material damage.
- Never put your finger or any other objects in the dispenser opening.
 - It may cause injury.
- Do not try to disassemble the ice maker.
- Do not wash or spray the ice bucket with water while it is in the refrigerator. Remove it to clean it.

PARTS AND FEATURES

Review the illustration below to become more familiar with the parts and features of your refrigerator.

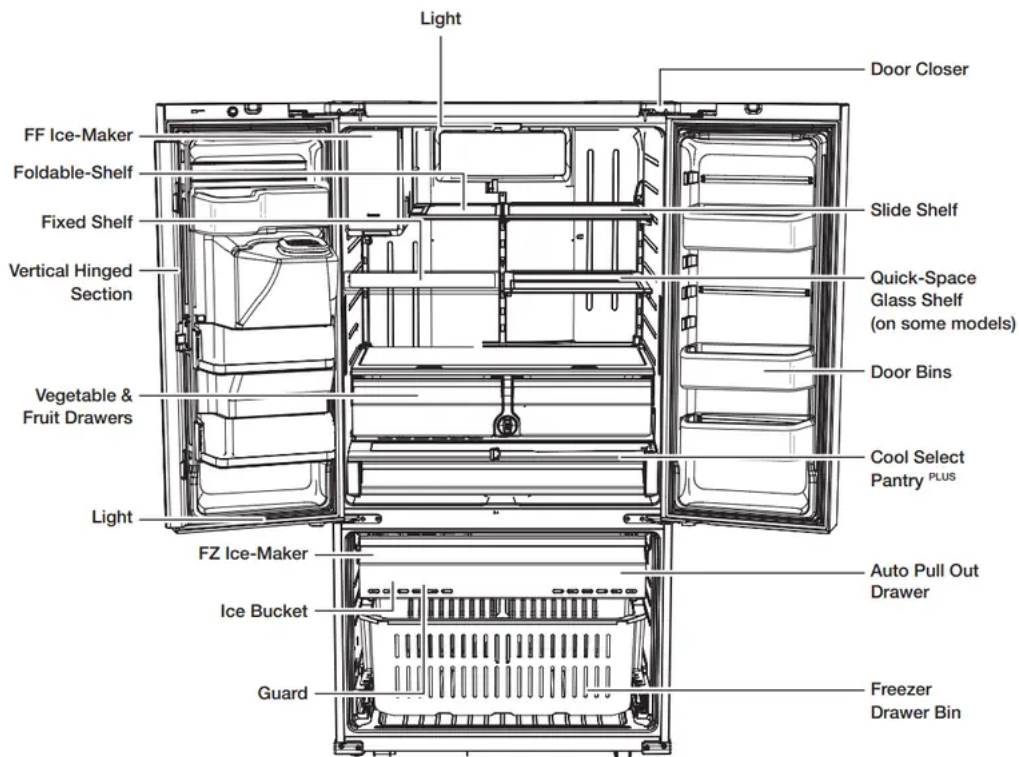

CLEANING THE REFRIGERATOR

Caring for your Samsung French Door Refrigerator prolongs the life of your appliance and helps keep the refrigerator free of odor and germs.

Cleaning the Interior

Clean the inside walls and accessories with a mild detergent and then wipe dry with a soft cloth. You can remove the drawers and shelves for a more thorough cleaning.

Just make sure to dry drawers and shelves before putting them back into place.

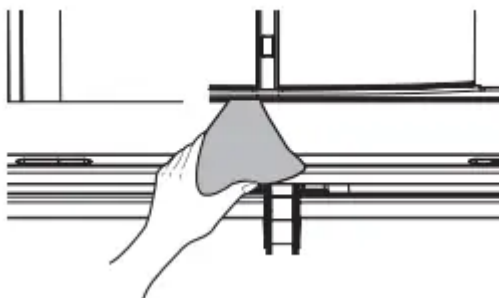

Cleaning the Exterior

Wipe the control panel and digital display with a damp, clean, soft cloth.

Do not spray water directly on the surface of the refrigerator.

The doors, handles, and cabinet surfaces should be cleaned with a mild detergent and then wiped dry with a soft cloth.

To keep your appliance looking its best, polish the exterior once or twice a year.



Cleaning the Ice / Water Dispenser

Push down one end of the tray dispenser and remove it.

Wipe the Ice / Water Dispenser with a clean and soft cloth.

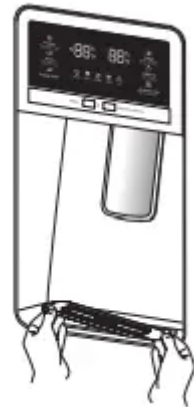

Cleaning the Rubber door seals

If the rubber door seals are dirty, the doors may not close properly, and the refrigerator will not operate efficiently. Keep the door seals free of dust or stains by cleaning the doors with a mild detergent and damp cloth.

Wipe dry with a clean, soft cloth.

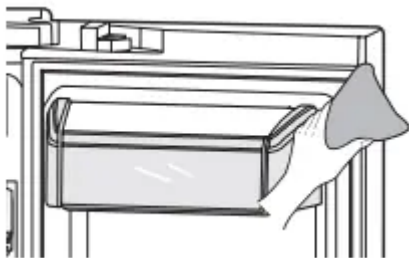

Cleaning the rear side of the refrigerator

To keep cords and exposed parts free of dust and dirt accumulation, vacuum the rear side of the appliance once or twice a year.

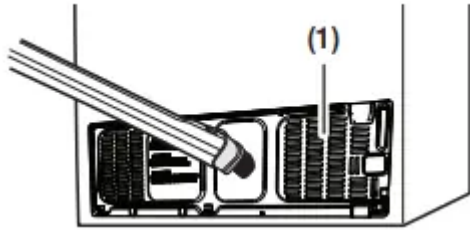

Troubleshooting

PROBLEM	SOLUTION
<p>The refrigerator does not work at all or it does not chill sufficiently.</p>	<ul style="list-style-type: none"> • Check if the power plug is properly connected. • Check if the set temperature on the digital display is warmer than the freezer or fridge inner temperature. If it is, set the freezer or fridge to a colder temperature. • Is the refrigerator in direct sunlight or located near a heat source? If so, it may not be able to cool sufficiently. Install it in a location that is out of direct sunlight and not near a heat source. • Is the back of the refrigerator too close to the wall, preventing proper ventilation? If so, it may not be able to cool sufficiently. Keep it an appropriate distance from the wall. • Is there too much food inside so that the food is blocking the outlet vent? To keep the refrigerator at a suitable temperature, do not fill the refrigerator with too much food.
<p>The food in the fridge is frozen.</p>	<ul style="list-style-type: none"> • Check if the set temperature on the digital display is too low. If so, raise the set temperature inside the refrigerator. • Is the temperature in the room too low? Set the refrigerator warmer. • Did you store food with a high moisture content in the coldest part of the refrigerator or near the cooling outlet vent? Try moving those items to the other shelves in the fridge instead of keeping them in the colder areas or bins.
<p>You hear unusual noise or sounds.</p>	<ul style="list-style-type: none"> • Check if the refrigerator is level and stable. • Is the back of the refrigerator too close to the wall, preventing proper ventilation? • Was anything dropped behind or under the refrigerator? • If you hear a “ticking” sound from inside the refrigerator, this is normal. It occurs because various



	<p>parts contract or expand in response to temperature changes in the refrigerator interior.</p> <ul style="list-style-type: none"> • If it sounds as if something is hitting something else inside the refrigerator, this is normal. The sound is caused by the compressor operating at high capacity
<p>The cabinet-door sealing area of the appliance is hot and condensation is occurring.</p>	<ul style="list-style-type: none"> • Some heat is normal as anti-condensators are installed in the vertical hinged section of the refrigerator to prevent condensation. • Is the refrigerator door ajar? Condensation can occur when you leave the door open for a long time.
<p>The ice Maker is not producing ice.</p>	<ul style="list-style-type: none"> • It may take longer to make ice if it is not sufficiently cool, such as when first installed. • Is the water line connected and the shut-off valve opened? • Did you manually stop the ice making function? • Check if the filter is properly installed. If it is not properly installed, the ice making function may not work.
<p>You can hear water bubbling in the refrigerator.</p>	<ul style="list-style-type: none"> • This is normal. <p>The bubbling comes from refrigerant circulating through the refrigerator</p>
<p>There is a bad smell in the refrigerator.</p>	<ul style="list-style-type: none"> • Check for spoiled food. • Foods with strong odors (for example, fish) should be tightly covered. • Clean out the freezer periodically and throw away any spoiled food. When cleaning the inside of the fridge, store food elsewhere and unplug the appliance. Wipe with a dry dishcloth after 2-3 hours and then circulate air inside the refrigerator.
<p>Frost forms on the walls of the freezer.</p>	<ul style="list-style-type: none"> • Is the air vent blocked? Remove any obstructions so air can circulate freely. • Allow sufficient space between the stored foods for efficient air circulation.

	<ul style="list-style-type: none"> • Is the freezer drawer closed properly? If the freezer drawer is not completely closed or is blocked, humidity from outside may enter and cause severe frost to form
The water dispenser is not functioning.	<ul style="list-style-type: none"> • Is the water line connected and the shut-off valve opened? • Has the water supply line tubing been crushed or kinked? • Make sure the tubing is free and clear of any obstruction. • Is the water tank frozen because the fridge temperature is too low? Try selecting a warmer setting on the Digital display. • Is the Child Lock on? • Check if the filter is properly installed. If it is not properly installed, the water dispenser may not work.
The auto close system does not work with the freezer door.	<ul style="list-style-type: none"> • Is there an imbalance between the right and left parts of the door? • Open and close the door smoothly 1~2 times. After you do this, the auto close system usually works properly again. • Try opening the door smoothly to avoid unbalancing the right and the left part of the door.
Condensation or water drops forms on vertical mullion and surroundings, etc.	<ul style="list-style-type: none"> • Condensation or water drops may form if the humidity is too high while the refrigerator is operating. • If condensation or water drops appears on vertical mullion and surroundings, etc., turn the Energy Saver mode off after removing the condensation. (See the explanation of the Energy Saver button in “Using the control panel” on page 19.)

Warning



This content is compiled from multiple sources and is provided for reference purposes only. It may not be complete or fully applicable to all situations. If you are unable to resolve your issue, please contact the product manufacturer or an authorized service provider for official support.

Document generated by [ManualsFile](#)