

## What's included

Make sure all the parts are included in the product package. If you have a problem with the dryer or the parts, contact a local Samsung customer center or the retailer.

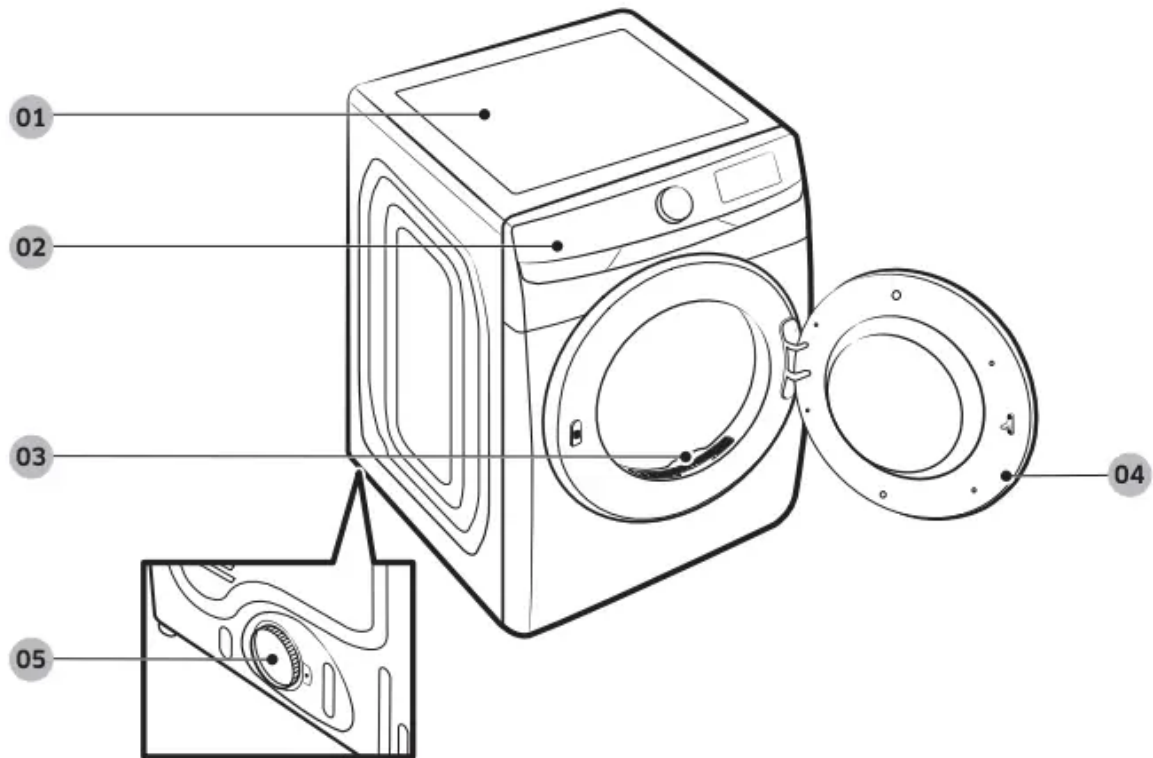

01 Worktop

02 Control panel

03 Lint filter

04 Door

05 Exhaust duct

## Before you start

Here are a few things you should know before starting your dryer.

### Sort and load

- Put one wash load in the dryer at a time.
- Do not mix heavy and lightweight items together.
- To improve drying efficiency for one or two items, add a dry towel to the load.

- For best results, untangle items before inserting them into the dryer. Tangled items may degrade the drying efficiency or cause the door to open.
- Overloading reduces the tumbling action, resulting in uneven drying and wrinkling.
- Unless recommended on the care label, do not dry woolens or fiberglass items.
- Avoid drying unwashed items.
- Do not dry items soiled with oil, alcohol, gasoline, etc.

## Functional prerequisite

### Lint filter

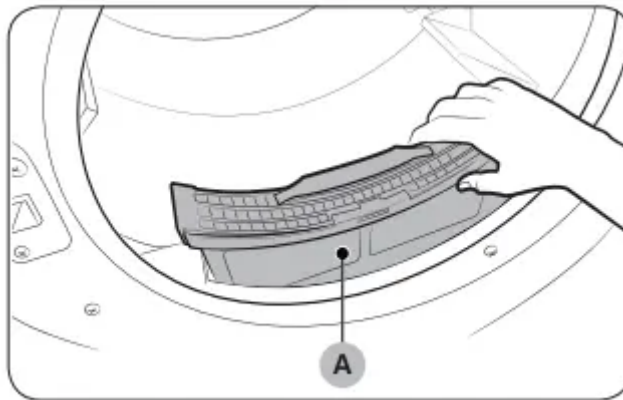

To prevent a risk of fire, make sure to clean the lint filter before or after every load.

1. Turn off the dryer.
2. Open the door and pull out the lint filter (A) from inside the drum.
3. Open the lint filter by separating it at the top. Remove the lint, and then clean the lint filter.
4. Close the lint filter, reinsert the lint filter into the dryer, and then close the dryer door.

### CAUTION

- Do not operate the dryer without the lint filter in place.
- Do not use a damaged or broken lint filter. This may reduce performance and/or cause fire.

## Operations

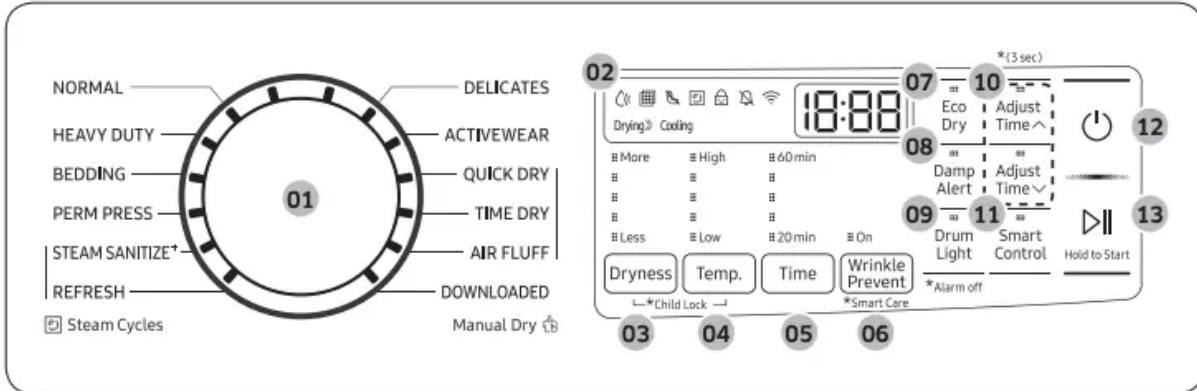

**WARNING** To reduce the risk of fire, electric shock, or injury, read the “Safety information” before operating this appliance.

# Control panel



<p><b>01 Cycle Selector</b></p>	<p>Turn the Cycle Selector to select the desired cycle. The indicator by the cycle name lights up.</p> <ul style="list-style-type: none"> <li>• Steam Cycles: The dryer sprays water into the drum to deodorize clothes and reduce static electricity and wrinkles.</li> <li>• Manual Dry: The drying time is fixed.</li> </ul>
<p><b>02 Digital Graphic Display</b></p>	<p>Displays all cycle information, including the cycle time, information code, and operating status.</p>
<p><b>03 Dryness</b></p>	<p>Press to select a dry level. You can select from 5 different options (Less to More). Please refer to following recommendations to select the appropriate dryness.</p> <ul style="list-style-type: none"> <li>• For larger or bulkier loads, select More for complete dryness.</li> <li>• For items that needs to lay flat or hang to dry, use Less to partially dry items.</li> </ul> <p><b>NOTE</b> This option is not available with REFRESH, STEAM SANITIZE , ACTIVEWEAR, TIME DRY, QUICK DRY, and AIR FLUFF.</p>
<p><b>04 Temp.</b></p>	<p>Temperature can only be adjusted in TIME DRY cycle. Press to change the temperature of the current cycle. You can select from 5 different options (Low to High). Please select the appropriate temperature depending on the items in the load.</p> <ul style="list-style-type: none"> <li>• High: For sturdy cottons or those labeled Tumble Dry.</li> <li>• Medium: For permanent press, synthetics, lightweight cottons, or items labeled Tumble Dry Medium.</li> <li>• Low: For heat sensitive items labeled Tumble Dry Low or Tumble Dry Warm. Provides the lowest heated drying temperature possible.</li> </ul>
<p><b>05 Time</b></p>	<p>Press Time to select a drying time for the selected cycle. This is available only with TIME DRY, QUICK DRY, and AIR FLUFF. This button is not available for Sensor Dry cycles because exact drying times are determined by fluctuating humidity levels.</p>
<p><b>06 Wrinkle Prevent</b></p>	<p>Wrinkle Prevent provides approximately 180 minutes of intermittent tumbling in unheated air at the end of the cycle to reduce wrinkling. Press Wrinkle Prevent to activate this feature.</p>



	The load is dry and can be removed at any time during the Wrinkle Prevent cycle.
<b>07 Eco Dry</b>	This function is available with NORMAL and TIME DRY. With the Eco Dry activated, drying takes a longer time but power consumption is reduced. The drying time can be extended by up to 3 times normal depending on the temperature and load. The Eco Dry function is enabled by default.
<b>08 Damp Alert</b>	This alert is available for all Sensor Dry cycles except for ACTIVEWEAR. Available dry levels are Normal, More, and Extra. If a load contains mixed fabrics, the Damp Alert indicator blinks when average dryness of the items in the load is 80 % dry. This lets you take items that you don't want fully dried or that dry quickly out of the dryer early while letting others continue to dry.
<b>09 Drum Light (DVE(G)45R6300* models only)</b>	Press to turn the interior lamp on or off. The lamp stays lit for 2 minutes after it has turned on, regardless of whether the power is on or off or the door is open or closed, and then turns off automatically.
<b>10 Adjust Time</b>	You can change the set time for the selected cycle. This is available only with TIME DRY, QUICK DRY, and AIR FLUFF. To change the cycle time, press Adjust Time  or Adjust Time  until the desired time is displayed.
<b>11 Smart Control (DVE45R6300* models only) / Smart Monitor (DVG45R6300* models only)</b>	After connecting the Tumble Dryer to your home network using the SmartThings app, you can control or monitor the dryer remotely. When started, the Smart Control (Smart Monitor) indicator blinks. The dryer enters waiting mode and waits for remote commands.
<b>12 Power</b>	Press to turn on/turn off the dryer.
<b>13 Start/Pause (Hold to Start)</b>	Press and hold to start operation or press to stop operation.









## NOTE

Do not take extremely tangled items from your washer and put them into the dryer. They can degrade the drying efficiency of the dryer or cause the door to open. We recommend that you untangle the items before putting them into the dryer. Also, do not put objects on the dryer, especially on the control panel.

## CAUTION

Do not spray water directly onto the control panel. This may cause a system failure.

### Icon description

 <b>Sensor Dry</b>	This icon appears when the dryer operates the cycle which senses the internal humidity to determine the drying time.
 <b>Filter Check</b>	This icon displays after every load as a reminder to clean the lint filter. Clean the lint filter before every cycle and make sure the filter is properly inserted before starting a cycle.
 <b>Vent Sensor</b> (DVE(G)45R6300* models only)	The dryer features a vent sensor that detects and notifies you when it is time to clean the ductwork. The  indicator lets you know the status of the duct.
 <b>Steam</b>	This icon appears when the dryer is in steam process. The dryer sprays water into the drum to deodorize clothes and reduce static electricity and wrinkles.
 <b>Child Lock</b>	This icon indicates that Child Lock is on. For more information on Child Lock, see page 51.
 <b>Alarm Off</b>	This icon indicates that the alarm is off. For more information on Alarm Off, see page 52.
 <b>Wi-Fi</b> (DVE(G)45R6300* models only)	This icon indicates that the dryer is connected to Wi-Fi.

### Simple steps to start

1. Press Power to turn the dryer on.
2. Turn the Cycle Selector to select a cycle.
3. Change the cycle settings (Dryness, Temp., and Time) as necessary.
4. Select desired options as necessary.
5. Press and hold Start/Pause (Hold to Start).

### To change the cycle during operation

1. Press Start/Pause (Hold to Start) to stop operation.
2. Select a different cycle, and repeat steps 2-4 above if necessary.
3. Press and hold Start/Pause (Hold to Start) again to start the new cycle.

## Cycle overview

### Standard Cycles

Cycle	Description
<b>NORMAL</b>	For most fabrics including cottons and linens. If Normal is selected, the Eco Dry function is enabled by default. For more information, see Eco Dry in the “Control panel” section.
<b>HEAVY DUTY</b>	For drying items made out of heavy fabrics, such as jeans, corduroys, or work clothes, with high temperature heat.
<b>BEDDING</b>	For bulky items such as blankets, sheets, and comforters
<b>PERM PRESS</b>	For drying wrinkle-free cottons, synthetic fabrics, knits, and permanent press fabrics automatically.
<b>STEAM SANITIZE+</b>	Use to sanitize items by applying steam and high-temperature heat to the fabric. This cycle can make items soft and reduce smells. Confirm that the laundry load is wet or partially wet before starting this cycle.
<b>REFRESH</b>	Use to smooth out wrinkles and reduce odors in loads of one to four items. With this cycle selected, a small amount of water is sprayed into the dryer drum after several minutes of tumbling with heat. Before removing the laundry, confirm that the laundry load is dry.
<b>DELICATES</b>	For heat-sensitive items at a low drying temperature.
<b>ACTIVEWEAR (DVE(G)45R6300* models only)</b>	For exercise wear and outdoor wear such as sports jerseys, training pants, water-repellent jackets, and other performance clothing. Thick fabrics like a zipper or velcro closure of a jacket, or training socks may not be completely dried.
<b>DOWNLOADED (DVE(G)45R6300* models only)</b>	<ul style="list-style-type: none"><li>• Select to choose from more cycles available on the SmartThings app on your smartphone.</li><li>• Available cycles: TOWELS, SANITIZE, SHIRTS, JEANS, WOOL, ECO NORMAL, SMALL LOAD, LOW TEMP., RACK DRY, WRINKLE AWAY</li><li>• Factory setting: WRINKLE AWAY</li></ul>

### Manual Dry

You can change the drying settings manually to your preference.



Cycle	Description
<b>QUICK DRY</b>	A quick drying cycle that runs for 30 minutes
<b>TIME DRY</b>	You can specify a cycle time in minutes. If TIME DRY is selected, the Eco Dry function is enabled by default. For more information, see Eco Dry in the “Control panel” section.
<b>AIR FLUFF</b>	Tumbles the load in room temperature air.







## Operations

### Cycle chart

#### NOTE

For best results, follow the load size recommendations for each dry cycle.

-  Large load: Fill the drum to about 3/4 full. Do not add items over this level as they need to tumble freely.
-  Medium load : Fill the drum to about 1/2 full.
-  Small load : Fill the drum with 3-5 items, not more than 1/4 full.

Cycle	Recommended items	Load size	Dry level
<b>NORMAL</b>	Cottons, work clothes, linens, mixed loads		Normal dry (Adjustable)
<b>HEAVY DUTY</b>	Heavy fabrics such as jeans, corduroys, heavy work clothes		Normal dry (Adjustable)
<b>BEDDING</b>	Bulky items such as blankets, sheets, comforters, pillows		Normal dry (Adjustable)
<b>PERM PRESS</b>	Shirts, synthetic fabrics, knits, wrinkle-free cottons, permanent press		Normal dry (Adjustable)
<b>STEAM SANITIZE<sup>+</sup></b>	Bedding, curtains, children's clothing		Very dry (Not adjustable)
<b>REFRESH</b>	Shirts, trousers, comforters, pillows		-
<b>DELICATES</b>	Underwear, blouses, lingerie		Normal dry (Adjustable)
<b>ACTIVWEAR</b> (DVE(G)45R6300+ models only)	Water-repellent wear, performance clothes, sports wear (Maximum : 4 lbs)		Normal dry (Not adjustable)
<b>QUICK DRY</b>	Small loads		-
<b>TIME DRY</b>	Any load		-
<b>AIR FLUFF</b>	Foam, rubber, plastic		-

#### NOTE

● : factory setting, ○ : can be selected

Cycle	Functions (Temp. Control)					Time
	High	⋮	⋮	⋮	Low	
NORMAL		●				
HEAVY DUTY	●					
BEDDING	●					
PERM PRESS			●			
STEAM SANITIZE <sup>+</sup>	●					
REFRESH	●					
DELICATES					●	
ACTIVEWEAR (DVE(G)45R6300* models only)		●				
QUICK DRY	●					○
TIME DRY	●	○	○	○	○	○
AIR FLUFF						○

Cycle	Options			
	Adjust Time	Damp Alert	Eco Dry	Wrinkle Prevent
NORMAL		○	● (DVE(G)45R6300*) ○ (DVE(G)45R6100*)	○
HEAVY DUTY		○		○
BEDDING		○		○
PERM PRESS		○		○
STEAM SANITIZE <sup>+</sup>				○
REFRESH				○
DELICATES		○		○
ACTIVEWEAR (DVE(G)45R6300* models only)				○
QUICK DRY	○			○
TIME DRY	○		●	○
AIR FLUFF	○			○

## Drying guide

The best way to dry items is to follow the instructions on the care label. If no drying instructions are provided, see the following table for reference.

Items	Description
<b>Bedspreads &amp; Comforters</b>	<p>Follow the care label instructions or dry using Bedding.</p> <ul style="list-style-type: none"> <li>• Make sure the item is thoroughly dry before using or storing.</li> <li>• May require repositioning in the drum to ensure even drying.</li> </ul>
<b>Blankets</b>	<p>Use Normal and dry only one blanket at a time for best tumbling action.</p> <ul style="list-style-type: none"> <li>• Make sure blankets are thoroughly dry before using or storing.</li> </ul>
<b>Curtains &amp; Draperies</b>	<p>Use PERM PRESS and the Medium temperature setting to help minimize wrinkling.</p> <ul style="list-style-type: none"> <li>• Dry curtains and draperies in small loads for best results and remove as soon as possible after the cycle is complete.</li> </ul>
<b>Cloth Diapers</b>	<p>Use Normal and the Medium temperature setting for soft, fluffy diapers.</p>
<b>Down-filled Items (jackets, sleeping bags, comforters, etc.)</b>	<p>Use Normal and the Medium temperature setting.</p> <ul style="list-style-type: none"> <li>• Add a couple of dry towels to absorb moisture and shorten drying time.</li> </ul>
<b>Foam Rubber (rug backs, stuffed toys, shoulder pads, etc.)</b>	<p>Do not dry on a heat setting.</p> <p><b>WARNING</b> Drying a rubber item with heat may damage it or cause a fire.</p>
<b>Pillows</b>	<p>Use Normal.</p> <ul style="list-style-type: none"> <li>• Add a couple of dry towels and a pair of clean sneakers to help the tumbling action and to fluff the pillows.</li> <li>• Do not dry kapok or foam pillows using a heated drying cycle.</li> </ul>
<b>Plastics (shower curtains, outdoor furniture covers, etc.)</b>	<p>Use TIME DRY and the Low temperature settings depending on the care label instructions.</p>

## WARNING

Do not dry:

- Fiberglass items (curtains, draperies, etc.)
- Woolens, unless recommended on the label
- Items spotted or soaked with vegetable or cooking oils

## Special features

### Child Lock

Child Lock prevents children from playing with the dryer. When Child Lock is activated, all buttons except for the Power button are disabled.

To activate/deactivate Child Lock, simultaneously press and hold Dryness and Temp. for 3 seconds.

### NOTE

Once Child Lock is activated, it will remain active even after you restart the dryer. If other buttons, except for the Power button, do not respond, check the Child Lock indicator. If the indicator is on, follow the instructions above to turn Child Lock off.

### Smart Care

To enable this function, you must first download the SmartThings app at the Play Store or the App Store and install it on a mobile device featuring a camera function. The Smart Care function has been optimized for Galaxy & iPhone series (applicable models only).

1. When the dryer detects an issue to check, an information code appears on the display. To enter Smart Care mode, press and hold Wrinkle Prevent for 3 seconds.
2. The dryer starts the self-diagnosis procedure and displays an information code if a problem is detected.
3. Run the SmartThings app on your mobile device, and then tap Smart Care.
4. Put the mobile device close to the dryer's display so that the smartphone camera and the dryer face each other. The app automatically recognizes the information code.
5. When the information code is recognized correctly, the app provides detailed information about the problem with applicable solutions.

### NOTE

- The function name, Smart Care, may differ depending on the language.
- If light is reflected off the dryer's display, the app may fail to recognize the information code.

- If the app fails to recognize the information code, you can enter the code manually in the app

### **Alarm off**

You can turn the alarm on or off. When the alarm is off, the melody of cycle completion and the power-off beep will not sound. However, the other sounds stay active.

- For the DVE(G)45R6300\* model, press and hold Drum Light for 3 seconds.
- For the DVE(G)45R6100\* model, press and hold Damp Alert for 3 seconds.
- Your setting will be retained even after you turn off the dryer. You can turn the alarm back on by pressing and holding the same button for 3 seconds.

### **Drum Light (DVE(G)45R6100\* models only)**

Press and hold Eco Dry for 3 seconds to turn the drum light on or off.

### **NOTE**

The lamp stays lit for 2 minutes after it has turned on, regardless of whether the power is on or off or the door is open or closed, and then turns off automatically.

### **DOWNLOADED cycle (DVE(G)45R6300\* models only)**

You can choose from more cycles available on the SmartThings app on your smartphone.

1. On your smartphone, select the DOWNLOADED cycle. You can choose from TOWELS, SANITIZE, SHIRTS, JEANS, WOOL, ECO NORMAL, SMALL LOAD, LOW TEMP., RACK DRY, and WRINKLE AWAY.
2. Press Power on your dryer.
3. Turn the Cycle Selector to DOWNLOADED.
4. Press and hold Start/Pause (Hold to Start).

### **Bixby (DVE(G)45R6300\* models only)**

With Bixby, you can easily enjoy variety of services and contents, and experience intelligent customization services. (Voice command function is supported on applicable products only. For the products that do not support the voice command, you can download and connect to the SmartThings app on any Samsung mobile devices that support voice command to use some of the products' functions through voice command.)

### **SmartThings (DVE(G)45R6300\* models only)**

#### **Wi-Fi connection**

On your smartphone, go to Settings, turn on the wireless connection, and then select your AP (Access Point).

- This appliance supports the Wi-Fi 2.4 GHz protocols.

## **Download**

On an app market (Google Play Store, Apple App Store, Samsung Galaxy Apps), find the SmartThings app using the search term “SmartThings”. Download and install the app on your device.

### **NOTE**

The app is subject to change without notice for improved performance.

## **Log in**

You must first log into SmartThings with your Samsung account. To create a new Samsung account, follow the instructions in the app. You don't need a separate app to create your account.

### **NOTE**

If you have a Samsung account, use the account to log in. A registered Samsung smartphone user automatically logs in.

## **To register your appliance to SmartThings**

1. Make sure your smartphone is connected to a wireless network. If not, go to Settings and turn on the wireless connection, and then select your AP (Access Point).
2. Open SmartThings on your smartphone.
3. If the “A new device is found.” message appears, select Add.
4. If no message appears, select + and then select your appliance from the list of devices available. If your appliance is not listed, select Device Type > Specific Device Model, and then add your appliance manually.
5. Register your appliance to the SmartThings app.
  - a. Add your appliance to SmartThings. Make sure your appliance is connected to SmartThings.
  - b. When registration is complete, then name of your appliance appears on your smartphone.

## **Maintenance**

Keep the dryer clean to prevent decreased performance and to lengthen its life.

### **WARNING**

Certain internal parts are intentionally not grounded and may present a risk of electric shock only during servicing.

Service Personnel - Do not contact the following parts while the appliance is energized: Control board and inlet valve.

## Vent sensor

The dryer features a vent sensor that detects and notifies you when it is time to clean the ductwork. The  indicator lets you know the status of the duct.

Level +  Indicator	Status	Action
0 - Off	The ductwork is not clogged.	
1 - On	<ul style="list-style-type: none"><li>• The duct or lint filter is clogged.</li><li>• The pressure applied to the duct is high because the duct is too long or bent.</li></ul>	<ul style="list-style-type: none"><li>• Check the lint filter or duct and clean if necessary.</li><li>• Check the duct connections and shorten or straighten the duct if necessary.</li></ul>
2 - Blinking	<ul style="list-style-type: none"><li>• The duct or lint filter is severely clogged.</li><li>• The pressure applied to the duct is very high because the duct is too long or bent.</li></ul>	<ul style="list-style-type: none"><li>• Check and clean the lint filter or duct and make sure they are not clogged.</li><li>• Check the duct connections and shorten or straighten the duct work.</li></ul>

If the dryer is in the Level 2 state, the  indicator blinks for 3 hours after the completion of the current cycle. If you press Power or open the door, the dryer powers off immediately.

### NOTE

- For duct installation, see “Exhaust ducting guide”.
- The dryer may keep running even if the duct is clogged, but the drying time will be extended.
- If the indicator turns on for the first time and is solid (not blinking), check and clean the lint filter and/ or duct.
- If the indicator turns on again later, it is because the duct is installed or connected with some restrictions (it’s too long or has too many bends). This is not a system failure. However, drying time may be extended or the drying performance may be degraded.

## Cleaning

### Control panel

- Clean with a soft, damp cloth. Do not use abrasive substances.

- Do not spray liquid cleaning agents directly onto the dryer display.
- Some laundry pre-treatment soil and stain removers may damage the control panel.
- When using liquid cleaning agents, apply them to the cleaning cloth. Do not apply them directly to the dryer. Wipe up any spills or overspray immediately.

### **Drum**

- Remove any stains from the drum with an allpurpose cleaner.
- Tumble old towels or rags to remove any remaining stains or cleaning substances. Stains may still be visible, but will not affect subsequent loads.

### **Powder coated drum**

To clean the powder coated drum, use a damp cloth with a mild, non-abrasive cleaner suitable for easily marred surfaces.

Remove cleaner residue and dry with a clean cloth.

### **Dryer exterior**

- Clean with a soft, damp cloth. Do not use abrasive substances.
- Protect the surface from sharp objects.
- Do not place any heavy or sharp objects or a detergent container on the dryer. They can scratch or damage the top cover of the dryer.
- The dryer has a high-gloss finish on the entire surface. Be careful not to scratch or damage the surface.

### **Exhaust system**

- Check and clean the exhaust system on a regular basis to maintain optimum performance.
- The external exhaust hood must be cleaned frequently to ensure proper air flow.

## **Troubleshooting**

### **Checkpoints**

If the dryer operates abnormally, first check the list of problems in the table below and try the suggested actions.

Problem	Action
<b>Does not run.</b>	<ul style="list-style-type: none"> <li>• Make sure the door is latched shut.</li> <li>• Make sure the power cord is plugged into a live electrical outlet.</li> <li>• Check your home's circuit breakers or fuses.</li> <li>• Press or tap Start/Pause (Hold to Start) again if the door was opened during a cycle.</li> <li>• Clean the lint filter.</li> </ul>
<b>Does not heat.</b>	<ul style="list-style-type: none"> <li>• Check your home's circuit breakers or fuses.</li> <li>• Some cycles do not require heat. Check the selected cycle again.</li> <li>• For a gas dryer, make sure the gas supply is on.</li> <li>• Clean the lint filter and exhaust duct.</li> <li>• The dryer may have moved into the cool-down phase of the cycle.</li> <li>• Turn off the Eco Dry option for the NORMAL or TIME DRY cycles. When the Eco Dry option is on, the dryer performs an air dry process in the beginning of the cycle to reduce energy consumption. The air dry process does not use heated air, so you may feel that the dryer is not being heated, but this is normal.</li> </ul>
<b>Does not dry.</b>	<ul style="list-style-type: none"> <li>• Check all of the above, plus...</li> <li>• Make sure the exhaust hood outside your home can open and close freely.</li> <li>• Check the exhaust system for lint buildup. Ducting should be inspected and cleaned annually.</li> <li>• Use a 4" rigid metal exhaust duct.</li> <li>• Do not overload. 1 wash load = 1 dryer load.</li> <li>• Dry heavy items and light weight items separately.</li> <li>• Large, bulky items, such as blankets or comforters, may require repositioning to ensure even drying.</li> <li>• Make sure that your washer is draining properly and extracting adequate water from the load.</li> <li>• The load may be too small to tumble properly. Add a few towels and restart the dryer.</li> </ul>



	<ul style="list-style-type: none"> <li>• The load may be too large to tumble properly. Remove some items and restart the dryer.</li> <li>• Clean the lint filter.</li> </ul>
<b>Is noisy.</b>	<ul style="list-style-type: none"> <li>• Check the load for objects such as coins, loose buttons, nails, etc. Remove promptly.</li> <li>• It is normal to hear the dryer gas valve or heating element cycle on and off during the drying cycle.</li> <li>• Make sure the dryer is leveled properly as outlined in the installation instructions.</li> <li>• It is normal for the dryer to hum due to the high velocity of air moving through the dryer drum, fan, or exhaust system.</li> </ul>
<b>Dries unevenly.</b>	<ul style="list-style-type: none"> <li>• Seams, pockets, and other similarly heavy areas may not be completely dry when the rest of the load has reached the selected dryness level. This is normal. You can choose a higher dryness level or a cycle that involves a higher dryness level.</li> <li>• If one heavy item is dried with a light weight load, such as one towel with sheets, it is possible that the heavy item will not be completely dry when the rest of the load has reached the selected dryness level.</li> <li>• For the best drying results, dry heavy items and light weight items separately.</li> </ul>
<b>Has odors.</b>	<ul style="list-style-type: none"> <li>• Household odors from paint, varnish, strong cleaners, etc. may enter the dryer with the surrounding room air. This is normal as the dryer draws the air from the room, heats it, pulls it through the tumbler, and exhausts it outside.</li> <li>• When these odors linger in the air, completely ventilate the room before using the dryer.</li> <li>• Use the REFRESH cycle. If odors persist, wash and dry the items again</li> </ul>
<b>Lint on clothes.</b>	<ul style="list-style-type: none"> <li>• Make sure the lint filter is cleaned before every load. For clothes that naturally build up lint, clean the filter during the cycle.</li> </ul>

	<ul style="list-style-type: none"> <li>• Some fabrics are lint producers (for example, a fuzzy white cotton towel) and they must be dried separately from clothes that are lint trappers (for example, a pair of black linen pants).</li> <li>• Divide larger loads into smaller loads for drying.</li> <li>• Check pockets thoroughly before drying, then dry clothes.</li> <li>• Remove lint inside the drum before drying a load.</li> </ul>
<b>Items still wrinkled after Wrinkle Prevent (Wrinkle Away, Wrinkle Release).</b>	<ul style="list-style-type: none"> <li>• Small loads of 1 to 4 items work best.</li> <li>• Load fewer items. Load similar-type items.</li> <li>• Take out the items immediately after drying is complete.</li> </ul>
<b>Water drips from the nozzle when the Steam cycles starts.</b>	<ul style="list-style-type: none"> <li>• This is steam condensation. The dripping water will stop after a short time.</li> </ul>
<b>Sprayed water is not visible during Steam cycles.</b>	<ul style="list-style-type: none"> <li>• Sprayed water is difficult to see when the door is closed.</li> </ul>
<b>Extended time</b>	<ul style="list-style-type: none"> <li>• Sensor Dry automatically senses the moisture in the load and shuts the dryer off when the selected dryness level is reached. The drying time can change according to the type and amount of laundry. See the cycle chart for reference.</li> </ul>

If a problem persists, contact a local Samsung service center.

## Information codes

If the dryer fails to operate, you may see an information code on the display panel. To determine what you should do, check the list of codes in the table below, and then try the suggested actions.

<b>Code</b>	<b>Action</b>
<b>dC</b>	<p>Operating the dryer with the door open.</p> <ul style="list-style-type: none"> <li>• Make sure the door is properly closed.</li> <li>• Make sure laundry is not caught in the door.</li> </ul>
<b>FC</b>	<p>Invalid power source frequency.</p> <ul style="list-style-type: none"> <li>• Try restarting the cycle.</li> <li>• If this information code remains, contact a Samsung service center</li> </ul>
<b>AC</b>	<p>Electronic control problem (Invalid Communication).</p> <ul style="list-style-type: none"> <li>• Contact a Samsung service center.</li> </ul>
<b>HC</b>	<p>High temperature heating check.</p> <ul style="list-style-type: none"> <li>• Clean the lint filter.</li> <li>• If this information code remains, contact a Samsung service center.</li> </ul>
<b>9C1</b>	<p>The electronic control needs to be checked.</p> <ul style="list-style-type: none"> <li>• Check if power is supplied properly.</li> <li>• If the information code remains, contact a Samsung service center.</li> </ul>
<b>tC</b>	<p>The Thermistor1 resistance is very low or high.</p> <ul style="list-style-type: none"> <li>• Check for a clogged lint screen.</li> <li>• Check if the vent system is restricted.</li> <li>• If this information code remains, contact a Samsung service center.</li> </ul>
<b>tC5</b>	<p>The Thermistor2 resistance is very low or high.</p> <ul style="list-style-type: none"> <li>• Check for a clogged lint screen.</li> <li>• Check if the vent system is restricted.</li> <li>• If this information code remains, contact a Samsung service center</li> </ul>

<b>dF</b>	<p>Incorrect door switch.</p> <ul style="list-style-type: none"><li>• Contact a Samsung service center.</li></ul>
-----------	-------------------------------------------------------------------------------------------------------------------

If any information code keeps appearing on the display, contact a Samsung service center.

**Warning**

This content is compiled from multiple sources and is provided for reference purposes only. It may not be complete or fully applicable to all situations. If you are unable to resolve your issue, please contact the product manufacturer or an authorized service provider for official support.

---

Document generated by [ManualsFile](#)

