

## USER MANUAL Speaker

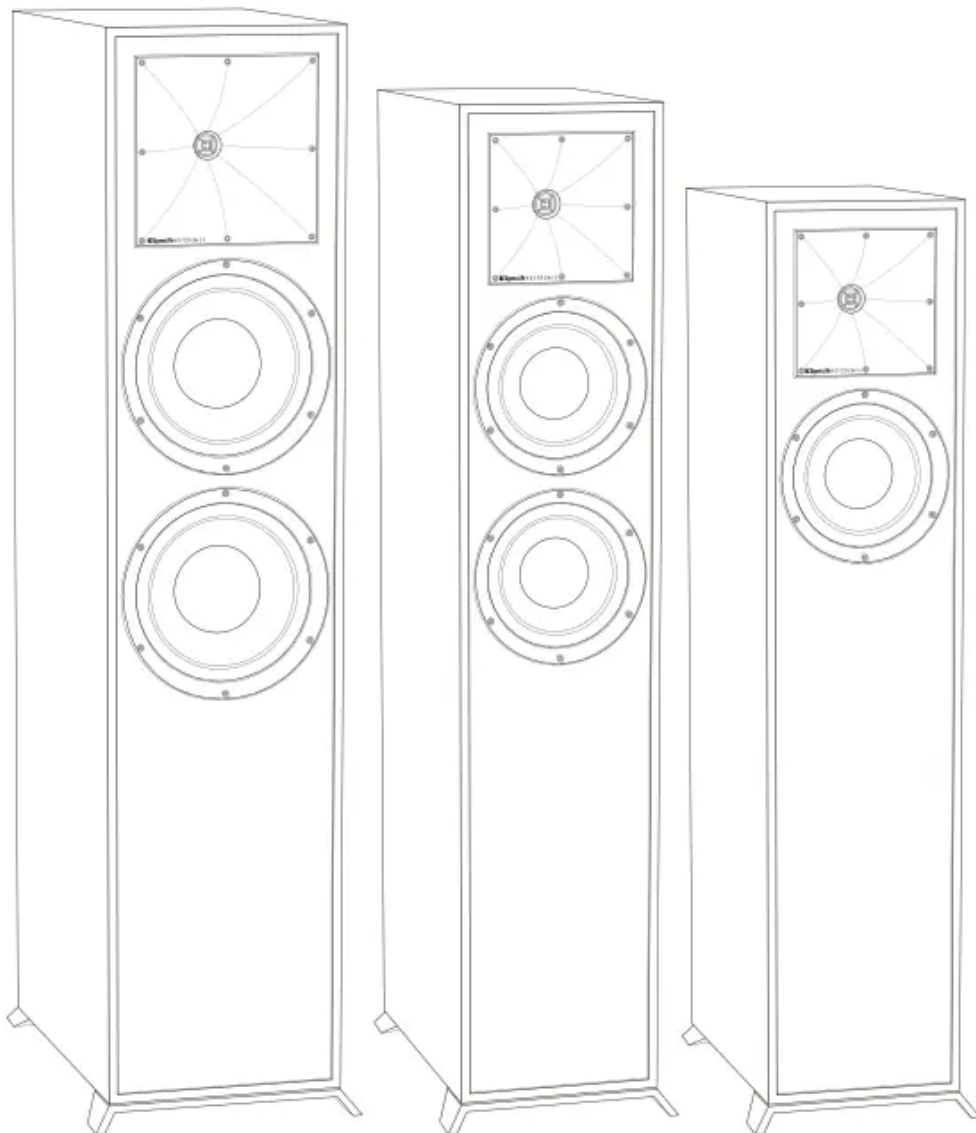

### REFERENCE (n):

- 1) the standard, the benchmark, the point used for comparison
- 2) the embodiment of the legendary Klipsch sound

### LOUD AND PROUD SINCE 1946

In 1946, Paul W. Klipsch revolutionized the audio industry by creating our proprietary horn technology and the acoustic principles that are the driving force behind our highly acclaimed signature sound.

Today, we remain true to PWK's vision and pack the better part of a century's worth of sweat and genius into every product we make. These speakers are the result of our obsession with that aural perfection.

Experience the power, detail and emotion of Klipsch Reference. We are the Keepers of the Sound®.

## REFERENCE SPEAKERS

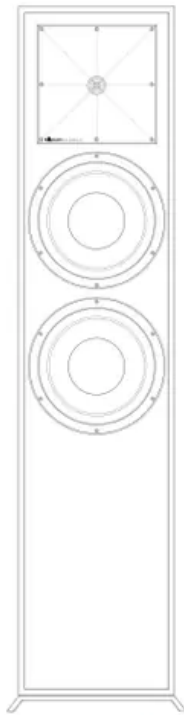

**R-820F**



**R-620F**



**R-610F**



**R-51M**



**R-41M**

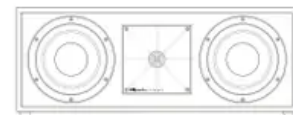

**R-52C**

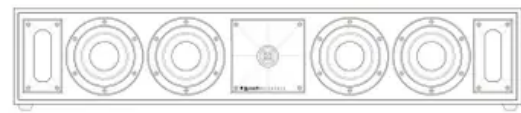

**R-34C**

**DOLBY ATMOS®**



**R-41SA**

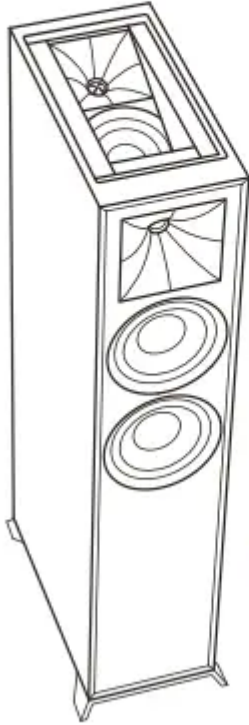

**R-625FA**

## **BEFORE YOU START**

- Some Klipsch® speakers have feet and other accessories that may need to be installed prior to use.

### FLOORSTANDING SPEAKERS

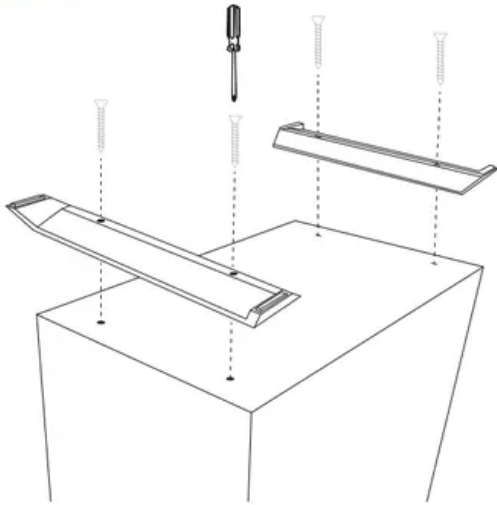

### CENTER CHANNEL SPEAKERS

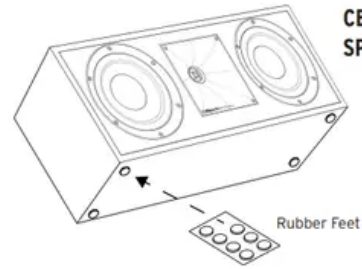

### MONITOR SPEAKERS

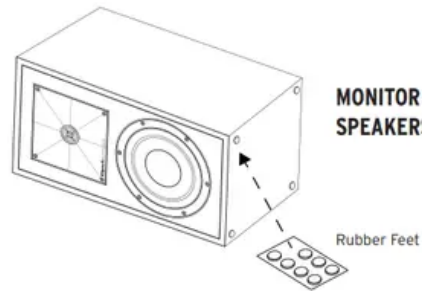

## ROOM PLACEMENT

**Left and Right Main Channel Speakers** — For optimum performance, Klipsch Group, Inc. (KGI) suggests placing your speakers 6 to 15 feet (1.8 to 4.6m) apart. They may also be toed-in slightly for better stereo imaging. The listening position should be about 1 to 1.5 times the distance separating the speakers. Refer to Figures 1 and 3 for connection and placement.

**Center Channel Speakers** — Center channel speakers are designed to place dialogue and primary sounds so that they appear to come from the video screen. The speakers should therefore be placed as close to the screen as possible, preferably directly on top of or below the screen. Refer to Figures 1, 2 and 3 for connection and placement.

**Rear Surround Channel Speakers** — Klipsch surround speakers should be placed approximately 2 feet above the listening position. Typically this will be about 5-7 feet above the floor. The surrounds should be placed on the walls directly adjacent to the listening position. Another option would be on the wall behind the listening position. The final surround speaker placement depends on your room's characteristics. They are designed to recreate the sense of space and ambience that many of today's surround sound technologies provide. Refer to Figures 1, 3 and 4 for connection and placement.

## CONNECTION

**Conventional Connection** — Using 16-12 gauge speaker wire, connect the RED "positive" (+) terminal of the LEFT speaker to the RED "positive" (+) terminal of your amplifier's LEFT channel. Connect the BLACK "negative" (-) terminal of the LEFT speaker to the BLACK "negative" (-) terminal of your amplifier's LEFT channel.

Repeat the above procedure for connecting all remaining speakers to the appropriate amplifier channels. Refer to Figure 3. Make sure that no bare wires from any of the connections touch any other terminals as this could cause a short and damage your equipment.

Some Klipsch Reference speakers come with dual binding posts that are connected by a metal strip. Do not remove this strip or your speakers will not function correctly. Keep this strip in place and connect your speaker wire to the top set of the binding posts. It is possible to “Bi-wire” a speaker that has two sets of binding posts. Please see your receiver’s manual for further instructions.

**Amplifier Requirements** — Klipsch speakers are highly efficient and will operate easily on a wide variety of amplifiers. All Klipsch speakers are 8-ohm compatible and can be driven to very high levels with low distortion. Due to the high output levels Klipsch speakers are capable of reproducing, exercise caution with the volume control. Excessive volume over long periods can permanently damage your hearing. Overdriving your amplifier could also damage your speakers. Check with your dealer or amplifier manual to make sure your particular amplifier is best suited to your application. We want you listening for a lifetime.

**FIGURE 1** SPEAKER PLACEMENT IN LISTENING AREA

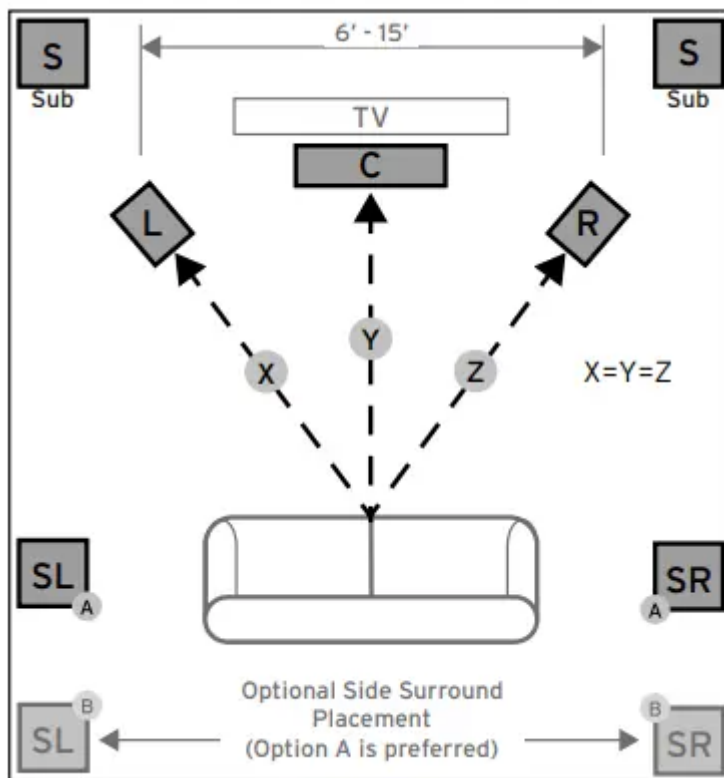

**FIGURE 2** CENTER CHANNEL

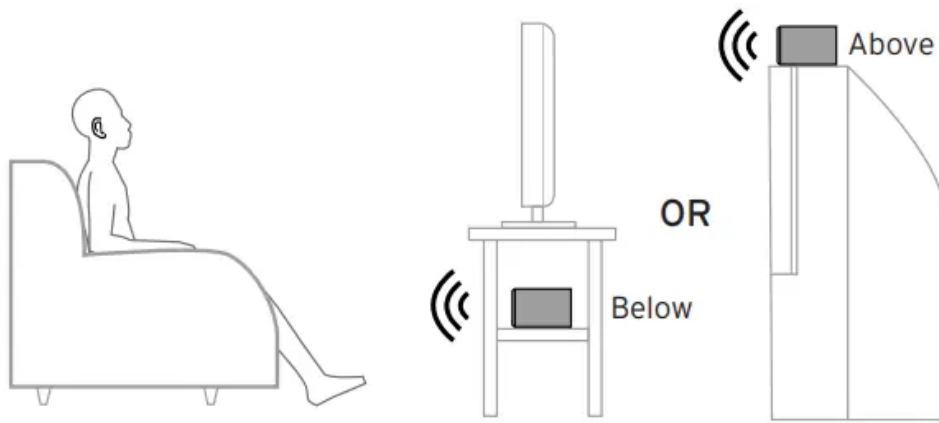

**FIGURE 3 STANDARD CONNECTIONS**

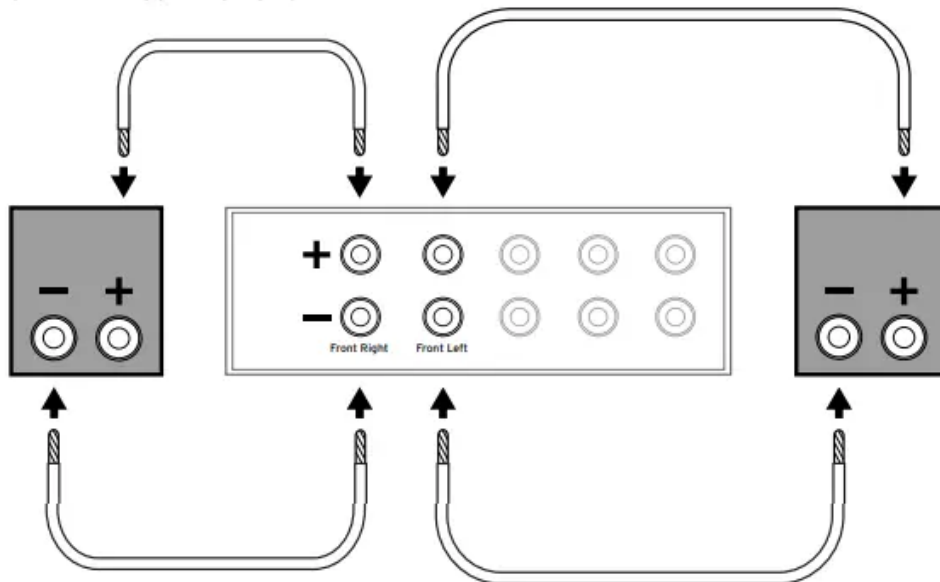

**FIGURE 4 WALL MOUNTING SURROUND SPEAKERS**

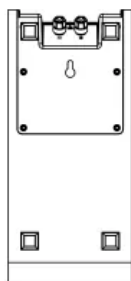

**CAUTION!**  
Do not use keyhole  
for ceiling mounting!

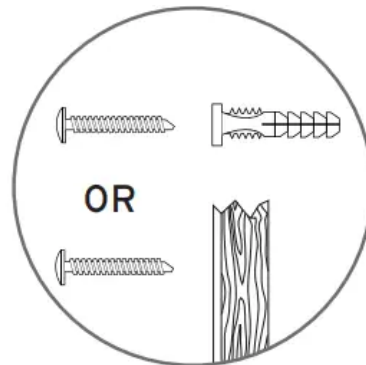

#10 or #12  
2.5" - 3" panhead wood screws  
Mount in wall stud or use anchors -  
leave 1/4" exposed

## REFERENCE WITH DOLBY ATMOS® TECHNOLOGY

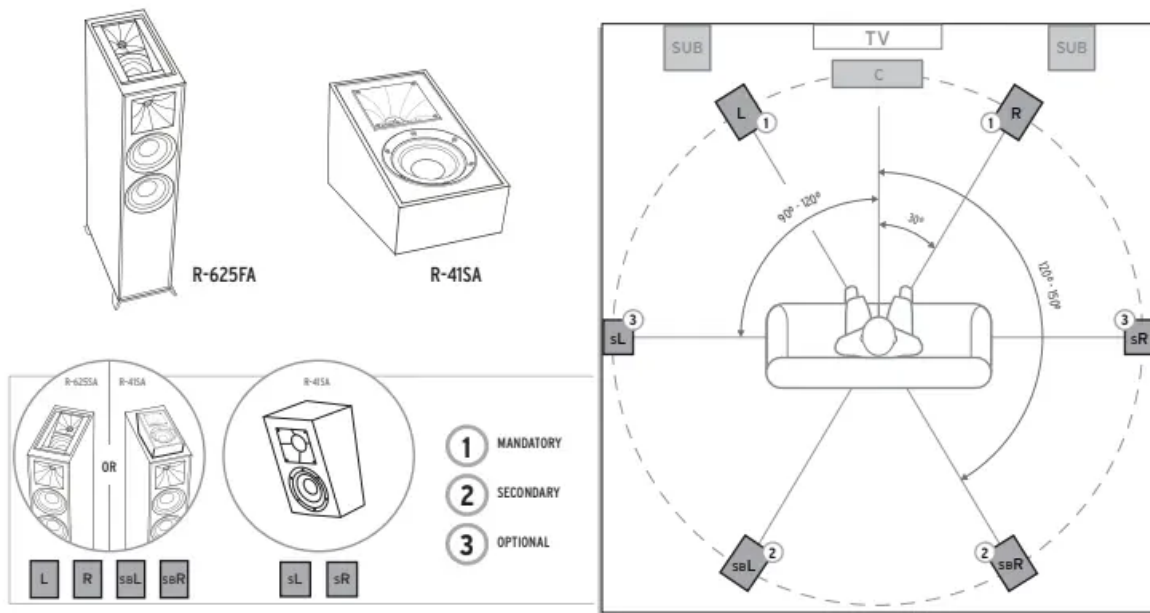

SPEAKER PLACEMENT IN LISTENING AREA

## CARE AND CLEANING

The only thing you should ever need to do to your speakers is dust them occasionally. Never apply any abrasive or solvent-based cleaner or any harsh detergent. You can clean the grilles with the brush attachment of a vacuum cleaner.

## PRODUCT REGISTRATION

Register your product online at [klipsch/register](https://www.klipsch.com/register)

- Keep up-to-date on new products and promotions.
- Your personal information will never be resold.
- This registration information is not used for warranty purposes.



## Product Description

Our proprietary speaker technologies are ideal for delivering the most immersive, impactful 360 degree Dolby Atmos listening experience. Controlled Directivity and high-performance have been an integral part of Klipsch Acoustic design principals for the better part of a century. Not just your typical full-range tower speaker, The R-625FA features a high performance up-firing Dolby Atmos speaker integrated in the top for an enveloping soundstage. It's a perfectly matched set up that virtually disappears. The integrated speaker terminals are placed low on the cabinet for convenience and an unobtrusive connection. Our exclusive Tractrix horn technology delivers the power, detail and emotion of the live music experience with the Cleanest, most natural sound possible. The exclusive linear travel suspension minimizes distortion for enhanced, detailed performances. Kapton is an extremely light and rigid material used in the tweeter suspension to provide high efficiency and improve resolution and detail. Its tweeters are a hallmark of Klipsch speakers, making it a core component of some of the best speakers in the world. Injection molded graphite (img) woofer cones are exceptionally light while being extremely rigid - providing remarkable low frequency response, with minimal cone breakup and distortion. When paired with the Tractrix horn-loaded its tweeter, it provides speaker efficiency highest in its class. The rear Tractrix port is perfectly matched to the cabinet and woofers, creating ideal airflow with minimal distortion or turbulence even at the lowest frequencies. Exposed fasteners, angled feet and low profile magnetic grilles give the speakers a polished, modern appearance. Stylish aesthetic with absolute durability that results in a seamless integration into any decor. Reinforced MDF construction reduces cabinet vibration for less audible coloration and improved sonic accuracy.

**Note:** Products with electrical plugs are designed for use in the US. Outlets and voltage differ internationally and this product may require an adapter or converter for use in your destination. Please check compatibility before purchasing.

## Product information

<b>Product Dimensions</b>	17.3 x 9.45 x 40 inches
<b>Item Weight</b>	49 pounds
<b>Manufacturer</b>	Klipsch
<b>ASIN</b>	B07FK6QH39
<b>Item model number</b>	R-625FA

## Q&A

**Q: I'm purchasing a pair of these a pair of bookshelves and a center speaker what's a decent receiver for these?**

**A:** We don't recommend certain brands as many customers prefer one brand over another for various reasons. Look for an AV receiver that is Dolby Atmos compatible with a low THD rating and the features you prefer.

Also, that front main speaker has a 100 Watt continuous power rating at 8 Ohms nominal with a 400 Watt peak. Our speakers can run efficiently off of 80% of their minimum power rating so at least we would recommend 80 Watts per channel at 8 Ohms for this model. We also don't recommend going over half way to the peak power on our speakers so the maximum recommended would be 200 Watts per channel at 8 Ohms.

**Q: What channel do you plug the upward facing speaker to?**

**A:** Back or height

**Q: Is it a set of 2 speakers for that price? klipsch r-625fa powerful detailed floorstanding single home speaker black**

**A:** Not sure what price u r being offered but u can purchase as a pair or a single speake

**Q: dissappointed to learn that I have 2 inputs to deal with. I'm a novice. bridge serially or pallel?**

**A:** There are actually two speakers in one speaker cabinet in this model R-625FA. The top inputs are for the Dolby Atmos height speaker channels outputs on a compatible AV receiver and the bottom inputs are for the front main speakers for use with the right and left main outputs on your AV receiver.

**Q: How dose this speaker compare to the r26fa?**

**A:** The R-26FA is the predecessor to the R-625FA . They are similar, but we used new tweeters, woofers, and networks in the R-625FA to give them a smoother sound.

**Warning**

This content is compiled from multiple sources and is provided for reference purposes only. It may not be complete or fully applicable to all situations. If you are unable to resolve your issue, please contact the product manufacturer or an authorized service provider for official support.

---

Document generated by [ManualsFile](#)

