

CARTON CONTENTS

REMOVE ALL PARTS FROM CARTON AND IDENTIFY EACH ITEM SHOWN.

MAKE SURE ALL PARTS ARE LOCATED BEFORE DISPOSING OF PACKING MATERIALS.



Tools Included in Mesh Bag

- A. Carpet Washer
- B. Water/Solution Tank
- C. Upper Handle
- D. Handle Screws
- E. SpinScrub® Brush Assembly (Pre-assembled in unit)
- F. Mesh Tool Storage Bag*
- G. Upholstery Tool
- H. Accessory Hose

HOW TO ASSEMBLE

NOTE: PHILLIPS SCREWDRIVER NEEDED FOR ASSEMBLY.

ATTACH HANDLE

1. Position upper handle and slide down into carpet washer base (Fig. 2)
2. Insert both screws and tighten with screwdriver (Fig. 3).

PLACE SOLUTION/ WATER TANK

3. Position bottom of tank onto Carpet Washer (Fig. 4).
4. Push tank handle while supporting back of cleaner with other hand until Solution Tank clicks into place (Fig. 5).
5. Check to make sure tank is securely latched.

STORE TOOLS

6. Place tools and hose into Mesh Tool Storage bag provided.
7. Mesh Tool Storage Bag should not be hung on the Carpet Washer while the Carpet Washer is in use.
8. Mesh Tool Storage Bag can be conveniently stored either on the back of the unit or hung elsewhere by the provided hook (Fig. 6).

CORD STORAGE

9. Wrap cord around cord hooks for convenient storage. Attach the plug end to cord.

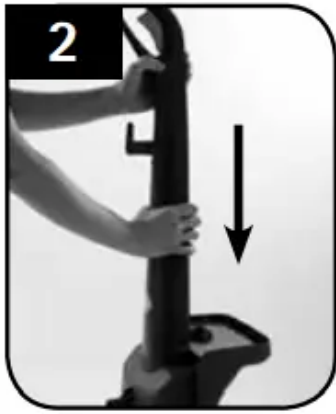

FEATURES

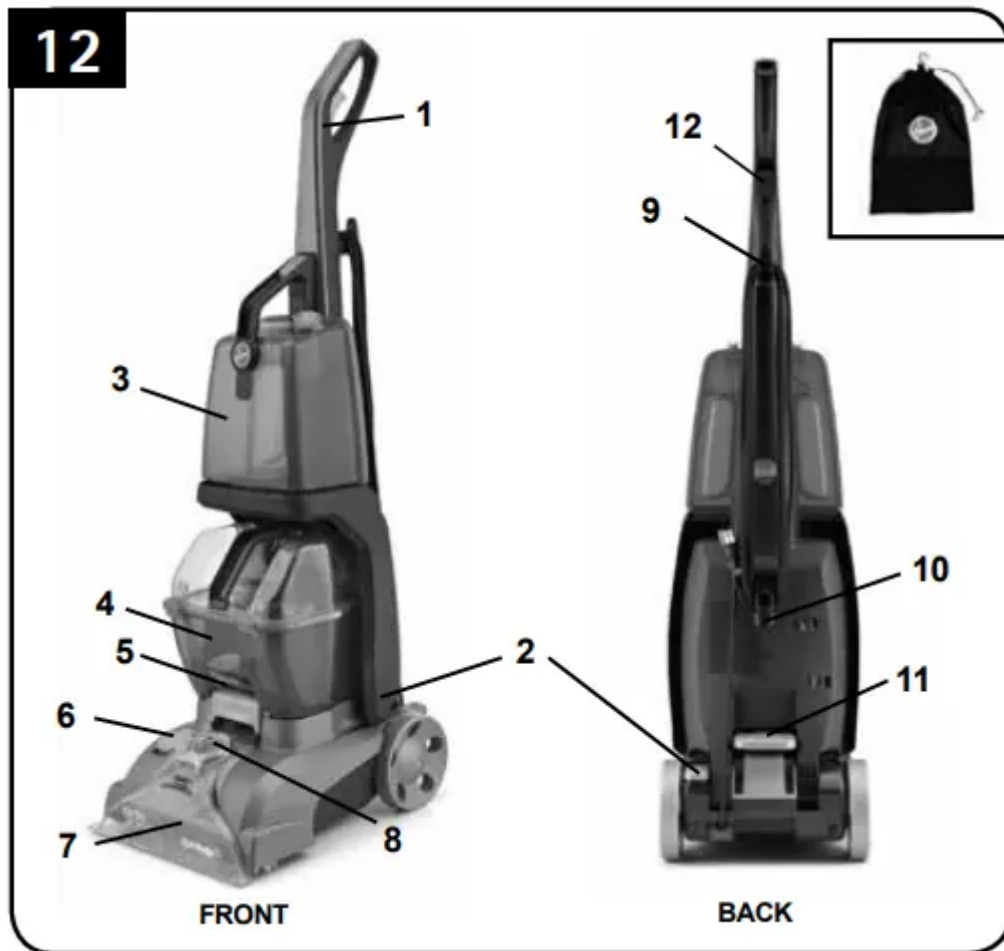

LIST OF FEATURES

1. Solution Trigger: Press to release cleaning solution
2. ON/OFF Pedal
3. Clean Water/Solution Tank
4. Dirty Water Tank
5. Dirty Water Tank Latch
6. Solution Tube Connection Port
7. Nozzle
8. Accessory Hose Connection Port
9. Cord Storage Hook
10. Cord Storage Hook (Does not rotate)
11. Handle Release Pedal
12. Cord Clip

HOW TO USE

CAUTION! Do not use this carpet washer and accessories on hard floors. Using this machine on hard floors may scratch or damage your floor.

ON-OFF PEDAL (Fig. 13, A)

1. To turn cleaner ON, step on pedal.
2. To turn cleaner OFF, step on pedal again.

HANDLE RELEASE PEDAL (Fig 13, B)

1. Grasp handle.
2. Step on Handle Release Pedal to release lower handle to operating position.
3. Do not release grip on handle until handle is returned into locked upright position.

TRANSPORTING

1. To move your cleaner from room to room, put handle in upright and locked position.
2. Tilt cleaner back on wheels and push forward (Fig. 14).

CARRY HANDLES

The carpet washer may also be lifted by any of several carry handles as shown. Be sure tanks are properly latched in place before attempting to lift (Fig 15).

- A. Upper Handle
- B. Solution Tank Handle
- C. Dirty Water Tank Handle
- D. Solution Tank Shelf

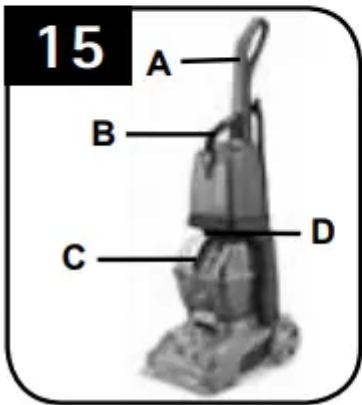

How to Fill

1. Turn off and unplug cleaner from electrical outlet.



2. To remove tank, press down on Solution Tank Latch and pull forward. (Fig. 17).
3. Fill Clean Water Tank (Fig. 18) with hot tap water to fill line. The use of hot water as opposed to cold, significantly improves cleaning performance.
4. Fill Solution Tank (Fig. 16-E) with Hoover® Clean Plus 2X Solution or any other Hoover solution by following the directions on the cleaning solution bottle (see “Cleaning Solutions” page 19 in manual for details). Replace container cap and tighten.

CAUTION! Do not fill with water above 140°F (60°C).

5. Place Solution/Water Tank back on to the unit using the method described on page 6.

NOTE: There may be a small amount of water on the base when the tank is removed from the unit. This is a normal condition.

CAUTION! Detergents contain Anionic and Nonionic Surfactants. Avoid contact with eyes and skin. In case of contact with eyes, flush with cold water for 15 minutes. In case of contact with skin, wash with water. If irritation persists, call a physician.

WARNING Use only HOOVER® cleaning products intended for use with this machine. (See the “Cleaning Solutions” section in this manual for details) They are specially formulated for use with your cleaner. Non-Hoover cleaning solutions may harm the machine and void the warranty

DIRTY WATER TANK

The Dirty Water Tank holds the dirty water that is picked up from the surface being cleaned.

When the Dirty Water Tank is full, the automatic shut-off will engage, suction will stop and the tank must be emptied (see Automatic Shut-Off section).

How to Empty

1. Turn cleaner off and unplug from electrical outlet.
2. Release Dirty Water Tank Latch (Fig. 20).
3. Grab the Dirty Water Tank Handle and remove from carpet washer (Fig. 21).
4. Unplug the Quick Spout Pour Cap (A), rotate it away from drain hole and empty the Tank (Fig. 22).

IMPORTANT Be sure to replace the Quick Spout Pour Cap to ensure proper suction.

5. Place Recovery Tank back on to cleaner making sure to do so with the retaining features (B, Fig. 23) pointing down to ensure proper sealing.
6. Latch the Recovery Tank back in to place.

IMPORTANT For full suction, it is important that the Dirty Water Tank is properly secured before cleaning.

How to Clean

1. Empty Dirty Water Tank.
2. Place on flat surface and unlatch Dirty Water Tank lid latch located below the Quick Spout Pour Cap (Fig. 24).
3. Pivot and lift off Dirty Water Tank Lid (Fig. 25).
4. Remove lint from filter screen located on the bottom of the Dirty Water Tank Lid (C, Fig. 25).
5. Rinse debris from Dirty Water Tank Lid and Dirty Water Tank bottom (Fig. 26).
6. Insert tabs on Dirty Water Tank lid and reattach lid to Dirty Water Tank bottom (D, Fig. 27a).
7. Reattach Recovery Tank Lid Latch.

IMPORTANT Regarding Dirty Water Tank Lid: For full suction it is important that the dirty water tank lid is securely in place. If misplaced, poor to no suction will result (see Figs. 27b, 27c).

AUTOMATIC SHUT OFF

When the Dirty Water Tank is full the yellow float disk will rise and shut off the carpet washer's suction.

The carpet washer will no longer pick up dirty water and the motor sound will become noticeably higher in pitch.

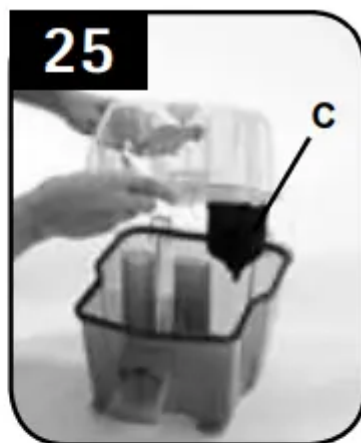
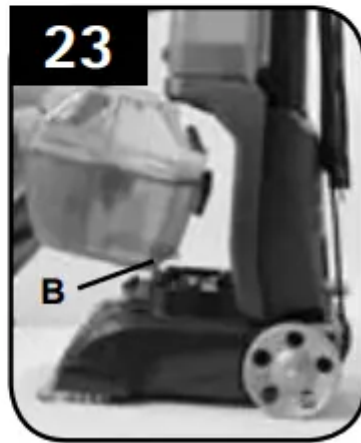
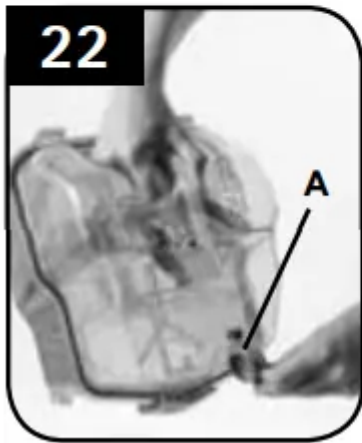

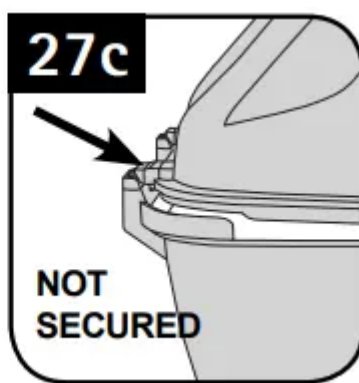
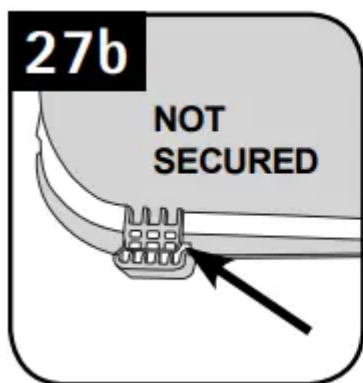

When this happens, turn carpet washer off and empty Dirty Water Tank before continuing use.

Check Clean Water/Solution Tank also; it may need to be refilled.

Do not use without float and float retainer in place. If broken or dislodged, take to an Authorized Dealer for repair.

HOW TO CLEAN

BEFORE YOU BEGIN CLEANING

1. Vacuum thoroughly - For carpet, use a HOOVER® vacuum cleaner with an agitator for best results. Vacuum upholstery with a vacuum cleaner with cleaning tool attachments. Use a crevice tool to reach into tufts and folds. Do not use the carpet cleaner as a dry vacuum cleaner.
2. For upholstery, check cleaning code - Use your HOOVER® carpet washer only if the upholstery fabric is marked with a "W" (for "wet" clean) or "S/W" (for "solvent/dry" or "wet" clean). Do not clean fabric marked "S" ("solvent/dry" clean only). If your upholstery does not have a code, seek professional assistance.
3. Test for colorfastness - Wet a white absorbent cloth with the solution. In a small, hidden area, gently rub the surface with the dampened cloth. Wait ten minutes and check for color removal or bleed with white paper towel or cloth. If surface has more than one color, check all colors.
4. When cleaning entire floor, move furniture out of area to be cleaned (may not be necessary if only high traffic areas are to be cleaned). For furniture too heavy to move, place aluminum foil or wax paper under legs. This will prevent wood finishes from staining carpet. Pin up furniture skirts and draperies.
5. Pretreat spots and heavy traffic areas with an appropriate Hoover Cleaning Solutions, see "Cleaning Solutions" section. Follow Directions on bottle. *Available at additional cost if not included with your model.

6. To prevent staining, use plastic or aluminum foil to protect wood or metal surfaces from possible water spray.

7. To avoid wetting and possible damage to wood floors underneath area rugs/carpet, either move area rugs/ carpet to a non-wood hard floor surface or place waterproof material (e.g. plastic) underneath them before cleaning.

WASHING CARPET

Read “Before You Begin Cleaning” instructions.

1. Fill Clean Water Tank according to instructions (Pg. 8).
2. Fill solution tank with Hoover® solution according to instructions (Pg. 8).
3. Dry hands and plug cord into a properly grounded outlet.

CAUTION Do not clean over floor electrical outlets.

NOTE: To avoid walking on damp carpet, start at the end of the room farthest from the door or path to sink where tanks will be emptied and filled.

4. Step on handle release pedal and lower handle to operating position.

Step 1

5. Turn cleaner ON.
6. Squeeze trigger to apply cleaning solution and slowly push cleaner forward (equals one wet stroke) (Fig. 29).
7. Continue to squeeze trigger and slowly pull cleaner back toward you (second wet stroke).



Step 2

8. Release trigger and slowly push cleaner forward over area just sprayed with solution (dry stroke). Then slowly pull cleaner back toward you without squeezing trigger (dry stroke). Continue using dry strokes until little water is visible passing through the Dirty Water Tank lid (Pass over the same area a minimum of 4 times = 2 while squeezing the trigger and 2 without).

NOTE: For best results, use straight, parallel strokes. Overlap strokes by 1 inch to help prevent streaking.

9. Keep nozzle flat on floor for both forward and reverse strokes.

For best cleaning results and to aid in faster drying of carpet, end with more dry strokes. (Continue using dry strokes until little water is visible passing through the Dirty Water Tank lid.)

Empty Dirty Water Tank when the motor sound becomes higher pitched and there is a loss in suction (see "Automatic shut-off").

When finished cleaning, follow "After Cleaning" instructions on page 12.

10. For best cleaning results, Hoover recommends to rinse the carpet with water only. This will remove residual carpet cleaning solution from your carpets. To Rinse with water only, fill solution tank with hot tap water only and repeat cleaning strokes.

11. For heavily soiled areas, repeat cleaning process. Avoid saturating carpet.

NOTE: It is best to alternate wet and dry strokes as described above.

IMPORTANT To avoid saturating carpet, do not use more than 4 wet strokes over one area. Always end with dry strokes.

AFTER USE

Allow carpet or upholstery to dry. To help prevent matting and resoiling the carpet, keep children and pets away from surface until it is completely dry. If it is necessary to walk on damp carpet, place towels or white cloths on the traffic areas.

If furniture must be replaced before the carpet is dry, place plastic or aluminum foil under legs of furniture so metal slides or wood finishes will not stain the carpet.

1. See "Dirty Water Tank: How to Empty" page 9.

2. See "Dirty Water Tank: How to Clean" page 9.

NOTE: Let Dirty Water Tank and Dirty Water Tank Lid air dry before Carpet Washer is stored.

3. See "Cleaning Nozzle" page 16.

4. See "Cleaning Brushes" page 16. 5. Remove lint from filter screen located behind nozzle.

IMPORTANT When brushes seem to be rotating slowly, disconnect cleaner from electrical outlet and check and clean the screen behind the nozzle (see arrow below).

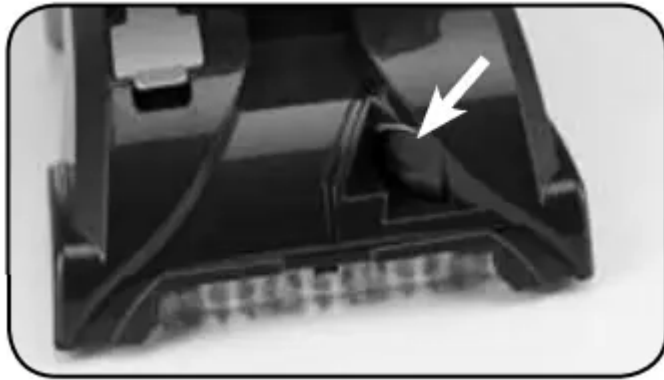

CAUTION! Water will drip from the brushes and underside of the product after use and may puddle. To avoid damage to wood and laminate flooring and to avoid potential slip hazard, after use (a) do not leave the product on wood and laminate surfaces and remove to a hard surface and (b) place unit on absorbent material (such as a towel) to soak up drips.

TOOLS

CONNECT HOSE FOR TOOL USE

CAUTION! Always turn off appliance before connecting or disconnecting hose.

How to Attach

1. Open Accessory Hose Suction Port (A, Fig. 31). Insert hose end, aligning the indicator with the unlock arrows.
2. Rotate clockwise to lock position (B, Fig. 31).
3. Hold open the Accessory Hose Solution Port door (Fig. 32).
4. Plug Accessory Hose Solution Tube connector firmly into Hose Solution Port (C, Fig. 32).

How to Remove

1. Disconnect Accessory Hose Solution Tube Connector from Accessory Hose Solution Port by pulling up firmly. Do not pull on tube, this may cause damage. Accessory port door will automatically close.

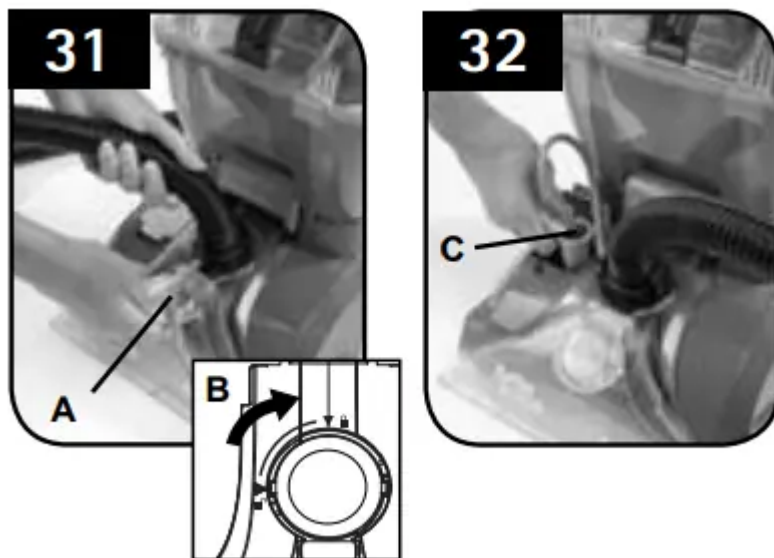

2. Rotate accessory Hose end counterclockwise from the locked position to the unlocked position and remove by pulling out.

3. Snap Accessory Hose Suction Port door back into place. Make sure to snap both sides to ensure proper suction, unit may lose suction if not closed properly.

TOOLS (*Available on select models only.)

A. Stair Tool*: 6 inches wide, 2 built-in rows of brushes to help provide the scrubbing action that some spots may need for removal on your carpeted stairs.

B. Upholstery Tool has a built-in brush to help provide the scrubbing action some spots may need for removal.

C. SpinScrub® Hand Tool* has rotating brush(s) for extra scrubbing action on small carpet areas, carpeted stairs and upholstery. For some models, the brush(s) can be removed for converting to the scrub module.

D. Crevice Tool*: Great for use around baseboards and those hard to reach areas.

NOTE: Tools located and stored in Mesh Bag.

How to Attach Tools

CAUTION!

- To reduce the risk of injury from moving parts - Unplug before connecting SpinScrub Hand tool.
- Not to be used for grooming pets.

1. To ensure maximum performance and to protect your carpet, be sure to place the handle in the upright position while using the accessory hose. Placing handle in the upright position shuts off the SpinScrub brushes.

NOTE: All tools attach to the hose in the same manner:

2. Connect tool to hose by sliding it onto connector until the tab locks it securely (E, Fig. 34).
3. Using your thumb, push forward and up on the latch to remove tool (F, Fig. 34).

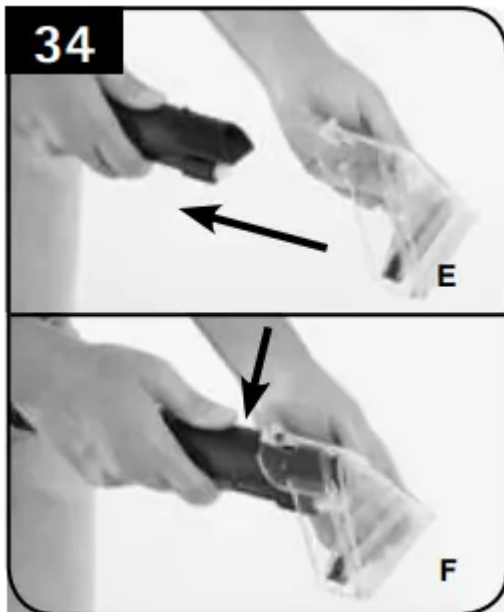
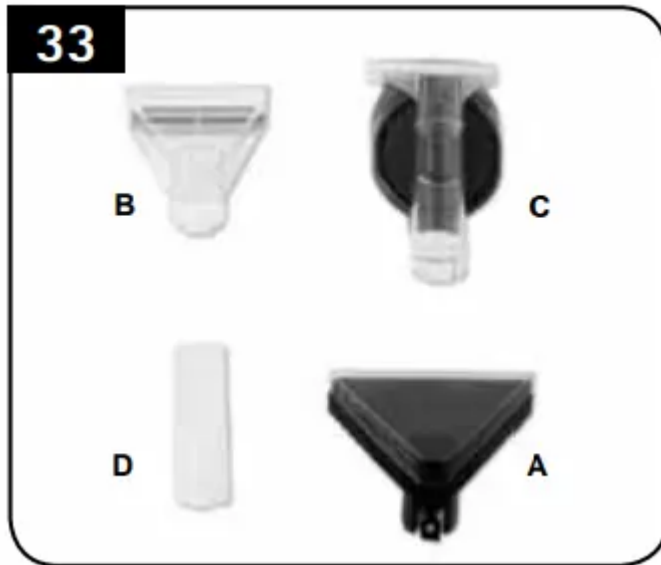

After Using Tool

1. Drain suction hose by turning cleaner ON and holding nozzle up for several minutes. Do not press trigger.

CAUTION! Always turn off appliance before connecting or disconnecting hose.

2. Disconnect hose and solution tube from cleaner.
3. Drain solution tube by placing round end in sink and raising the trigger end at the hose nozzle above your head (Fig. 35). Press the trigger to release air and fluid..

4. Replace Hose and tools in the Mesh Storage Bag.

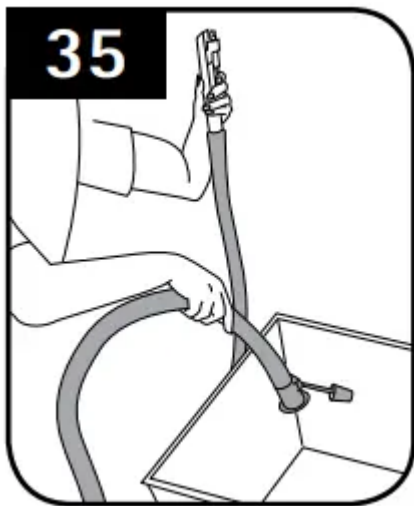

CLEANING UPHOLSTERY

Read “ Before You Begin Cleaning” instructions.

Be sure to check Hoover Cleaning Guide on page 10 and the cleaning code on your upholstery. Use your cleaner only on upholstery marked “W” or “W/S”.

1. Attach hose and solution tube as instructed.
2. Place handle in upright position. SpinScrub brushes will not rotate while handle is in upright position.
3. Fill Clean Water Tank according to instructions on (Pg. 8).
4. Fill solution container with HOOVER® solution according to instructions on (Pg. 8). Do not use hard floor cleaning solution when cleaning upholstery.
5. Attach tool to end of hose.
6. Dry hands and plug cleaner into a properly grounded outlet.
7. Turn cleaner ON.
8. Gently press the tool onto the fabric. Press the trigger and slowly pull the nozzle over the fabric (Fig. 39).
9. Overlap strokes by 1/2 inch to help prevent streaking.
10. Make additional strokes without pressing the trigger to remove more solution. To clean in corners or creases, lift the tool one half inch from the fabric and press the solution trigger.
11. For heavily soiled areas, it may be necessary to repeat the cleaning process. Make crisscrossing strokes to the original pattern; overlap each pass (Fig. 40). Make no more than 2 passes with the solution over any one area to prevent over-wetting and damage to fabric.

12. If you would like to rinse the carpet surface with water only, fill the clean water/solution tank with water only. For best cleaning results Hoover recommends to rinse the carpet with water only. This will remove residual carpet cleaning solution from your carpets.

If additional cleaning is necessary, wait until the upholstery is completely dry before using the tool again.

Empty Dirty Water Tank when the motor sound becomes higher pitched and there is a loss in suction (see "Automatic Shut-Off").

When finished cleaning, follow "After Cleaning" and "After Using Tool" instructions.

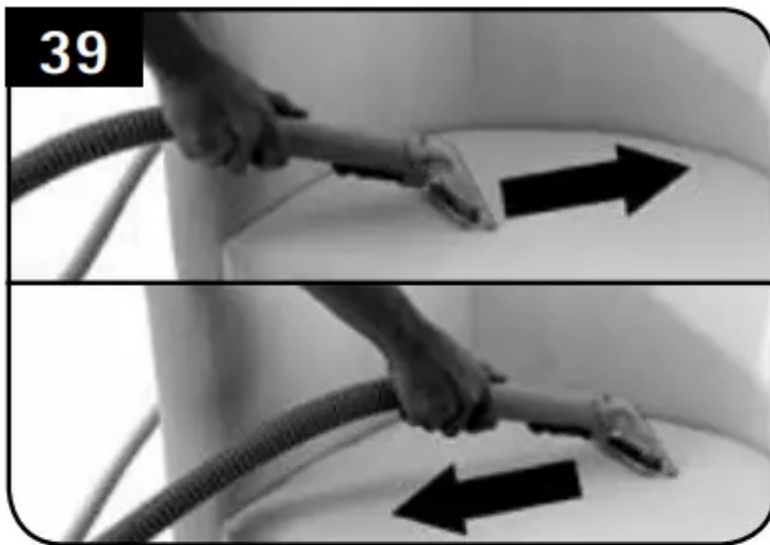

MAINTENANCE

Familiarize yourself with these home maintenance tasks as proper use and care of your cleaner will ensure continued cleaning effectiveness.

Any other servicing should be done by an authorized service representative.

If appliance is not working as it should, has been dropped, damaged, left outdoors, or dropped into water, take it to a service center prior to continuing use.

NOZZLE: How to Clean

If lint or other debris becomes lodged in nozzle, it can be removed for cleaning.

CAUTION! To reduce the risk of injury from moving parts - Unplug before servicing.

1. To prevent possible leaking, remove Clean Water Tank and Dirty Water Tank.
2. With handle in upright position, tilt carpet washer back so that handle rests on the floor.
3. Rotate nozzle latch to unlock position (Fig. 41).
4. Pull up on nozzle slightly to unsnap nozzle from foot of carpet washer.
5. Pull nozzle forward to remove from carpet washer. Be sure the nozzle does not get caught on retention tank latch (Fig. 42).
6. Rinse debris from nozzle.
7. Position nozzle on to foot, making sure to align the tabs at the bottom of the nozzle with the notches on the foot (Fig. 43).
8. Snap nozzle to foot.
9. Rotate nozzle latch to lock position.

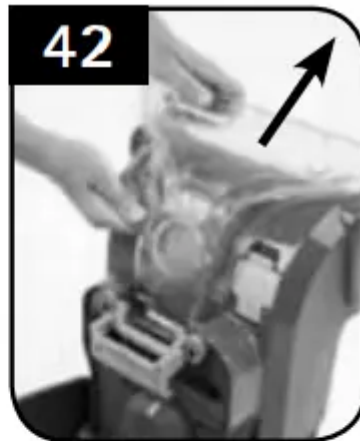

IMPORTANT The nozzle must be in the proper position in order for the Dirty Water Tank to go on properly and for the unit to have proper suction.

BRUSHES: How to Change and Clean

Your cleaner is equipped with removable brushes. Follow these directions for changing brush assemblies or for easy cleaning.

CAUTION! To reduce the risk of injury from moving parts - Unplug cleaner before servicing.

How to Remove

1. To prevent possible leaking, remove Clean Water Tank and Dirty Water Tank.
2. With handle in upright position, tilt cleaner back until handle rests on the floor.
3. Grab brush assembly and pull firmly (Fig. 44).
4. The brushes can be cleaned under running water.

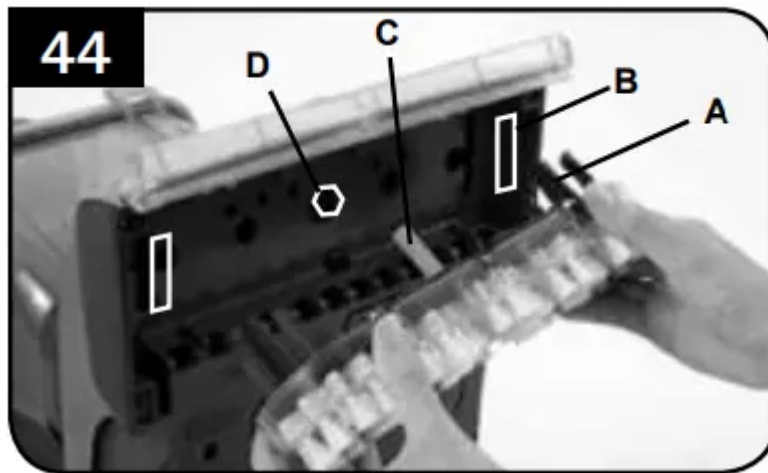

How to Replace

1. Align posts (A) on both ends of brush assembly with slots (B) in cleaner housing (Fig. 44).
2. Make sure that the hexagonal post (C) also aligns with the hexagonal hole (D). Turn brushes slightly until post fits easily into hole.
3. Press brush assembly firmly to snap into place.

STORAGE

Before storing:

- Empty Clean Water Tank and let air dry. Replace on cleaner.
- Empty Dirty Water Tank, rinse tank and lid thoroughly with clean water and let air dry.

Allow brushes and underside of carpet cleaner to air dry thoroughly before storing carpet cleaner on a carpeted or wood surface.

LUBRICATION

The motor is equipped with bearings that contain sufficient lubrication for the life of the motor.

The addition of lubricant could cause damage. Therefore, do not add lubricant to motor bearings.

TROUBLESHOOTING

If a minor problem occurs, it usually can be solved quite easily when the cause is found by using the checklist below.

Any other servicing should be done by an authorized service representative.

If appliance is not working as it should, has been dropped, damaged, left outdoors, or dropped into water, take it to a service center prior to continuing use.

WARNING! To reduce risk of personal injury - Unplug before cleaning or servicing.

PROBLEM	POSSIBLE CAUSE	POSSIBLE SOLUTION
Cleaner won't run.	<ol style="list-style-type: none"> 1. Not firmly plugged in. 2. No voltage in wall plug. 3. Blown fuse or tripped breaker. 4. Fuse in cleaner blown. 	<ol style="list-style-type: none"> 1. Plug unit in firmly. 2. Check fuse or breaker in home. 3. Replace fuse or reset breaker in home. 4. Take to service center.
Low suction.	<ol style="list-style-type: none"> 1. Dirty Water Tank full/ automatic shut off engaged. 2. Blockage In tool on end of hose. 3. Dirty Water Tank lid not on correctly. 4. Dirty Water Tank Debris Filter Clogged. 5. Blockage in nozzle. 6. Recovery Tank not properly secured. 	<ol style="list-style-type: none"> 1. Remove and empty Dirty Water Tank. See "How to Empty" page 9. 2. Remove tool and clear blockage. 3. Make sure lid is on securely. See "How to Use" on page 9. 4. See "How to Clean" page 5. 5. See "How to Clean" page 15. 6. Replace Recovery Tank as per instructions on page 9.
Hose nozzle stops spraying liquid during use.	<ol style="list-style-type: none"> 1. Clean Water Tank or Detergent Container is empty. 	<ol style="list-style-type: none"> 1. Turn off cleaner and fill Clean Water Tank and Detergent Container.
Hose nozzle will not spray after filling the	<ol style="list-style-type: none"> 1. Air is trapped in the pump and hose. 	<ol style="list-style-type: none"> 1. Turn on the cleaner. If hose does not spray, prime the pump by lowering the hose down to the floor

Clean Water Tank or Detergent Container.		and hold the trigger for up to 1 minute.
Hose nozzle will not spray after priming pump.	1. Pump is defective.	1. Call for service: 1-800-944-9200
Clean water won't dispense.	1. Clean Water Tank not firmly in place. 2. Clean Water Tank or solution container empty.	1. Make sure tank is securely locked in position. 2. Refill container according to instructions for surface being cleaned.
Brushes won't rotate during floor cleaning.	1. Dirty filter screen on front of unit behind nozzle.	1. Clean screen.

IMPORTANT SAFETY INSTRUCTIONS

SAVE THESE INSTRUCTIONS

When using an electrical appliance, basic precautions should always be followed, including the following:

READ ALL INSTRUCTIONS BEFORE USING THIS APPLIANCE.

ARNING: TO REDUCE THE RISK OF FIRE, ELECTRIC SHOCK OR INJURY:

- Fully assemble before operating.
- Operate cleaner only at voltage specified on data plate on lower handle of cleaner.
- Do not leave appliance when plugged in. Unplug from outlet when not in use and before cleaning or servicing.
- Use indoors only.
- Do not immerse. Use only on carpet moistened by cleaning process.
- Use only HOOVER® cleaning products intended for use with this machine. (See the "Cleaning Products" section of this manual.)
- Do not allow to be used as a toy. Not intended for use by children age 12 and under. Close supervision is necessary when used near children. To avoid injury or damage, keep children away from product, and do not allow children to place fingers or other objects into any openings.

- Use only as described in this manual. Use only manufacturer's recommended attachments and products.
- Do not use with damaged cord or plug. If appliance is not working as it should, has been dropped, damaged, left outdoors, or dropped into water, take it to a service center prior to continuing use.
- Do not pull or carry by cord, use cord as a handle, close a door on cord, or pull cord around sharp edges or corners. Do not place product on cord. Do not run appliance over cord. Keep cord away from heated surfaces.
- Do not unplug by pulling on cord. To unplug, grasp the plug, not the cord.
- Do not handle plug or appliance with wet hands.
- Do not put any object into openings. Do not use with any opening blocked; keep free of dust, lint, hair, and anything that may reduce air flow.
- Keep hair, loose clothing, fingers, and all parts of body away from openings and moving parts.
- Turn off all controls before unplugging.
- Use extra care when cleaning on stairs. To avoid personal injury or damage, and to prevent the cleaner from falling, always place cleaner at bottom of stairs or on floor. Do not place cleaner on stairs or furniture, as it may result in injury or damage.
- Do not use to pick up flammable or combustible materials, such as gasoline, or fine wood sandings, or use in areas where they may be present.
- Connect to a properly grounded outlet only. See Grounding Instructions.
- Unplug before connecting SpinScrub® Hand Tool.
- Do not pick up anything that is burning or smoking, such as cigarettes, matches, or hot ashes.
- Do not use without Tanks or Filters in place.
- Do not clean over floor electrical outlets.
- **WARNING:** This product contains chemicals known to the State of California to cause cancer, birth defects or reproductive harm. **WASH HANDS AFTER HANDLING.**

CAUTION - TO REDUCE THE RISK OF DAMAGE:

- Avoid picking up hard, sharp objects with this product, as they may cause damage.
- Store appropriately indoors in a dry place. Do not expose machine to freezing temperatures.
- Do not use sharp objects to clean out hose as they can cause damage.
- To assist in reducing drying time, be certain the area is well ventilated when using detergents and other cleaners with this machine.

- To help prevent matting and resoiling, avoid contact with carpets until they are dry. Keep children and pets away from carpets until they are completely dry.
- Do not store extractor with solution in tanks.
- With brushes on, do not allow cleaner to sit in one location for an extended period of time, as damage to the floor can result.
- Do not use this extractor and accessories on hard floors. Using this machine on hard floors without proper attachment may scratch or damage your floor.
- Water will drip from the brushes and underside of the product after use and may puddle. To avoid damage to wood and laminate flooring and to avoid potential slip hazard, after use (a) do not leave the product on wood and laminate surfaces and remove to a hard surface and (b) place unit on absorbent material (such as a towel) to soak up drips.

GROUNDING INSTRUCTIONS

This appliance must be grounded. If it should malfunction or breakdown, grounding provides a path of least resistance for electric current to reduce the risk of electric shock. This appliance is equipped with a cord having an equipment-grounding conductor (C) and grounding plug (A). The plug must be inserted into an appropriate outlet (B) that is properly installed and grounded in accordance with all local codes and ordinances.

WARNING: Improper connection of the equipment-grounding conductor can result in the risk of electric shock. Check with a qualified electrician or service person if you are in doubt as to whether the outlet is properly grounded. Do not modify the plug provided with the appliance - if it will not fit the outlet, have a proper outlet installed by a qualified electrician. This appliance is for use on a nominal 120-volt circuit and has a grounding plug that looks like the plug (A) illustrated in Fig. 1. A temporary adapter (D) may be used to connect this plug to a 2-pole receptacle (E) if a properly grounded outlet is not available (Fig. 2). The temporary adapter should be used only until a properly grounded outlet (B) can be installed by a qualified electrician (Fig. 1). The green colored rigid ear, lug, or the like (F) extending from the adapter must be connected to a permanent ground (G) such as a properly grounded outlet box cover (Fig. 2). Whenever the adapter is used, it must be held in place by a metal screw. NOTE: In Canada, the use of a temporary adapter is not permitted by the Canadian Electrical Code.

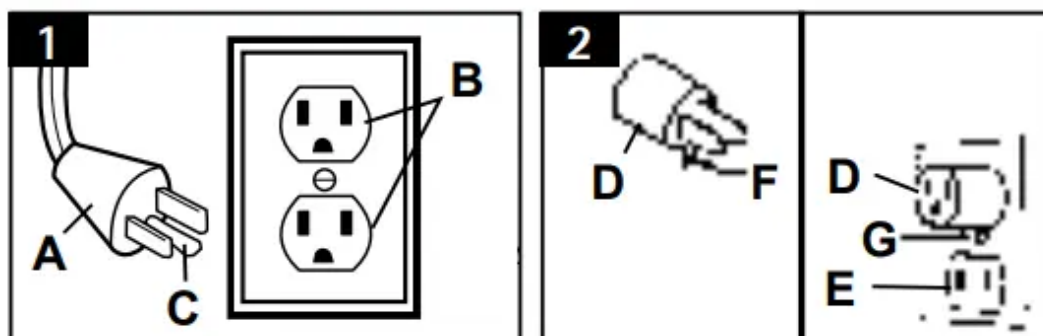

Warning

This content is compiled from multiple sources and is provided for reference purposes only. It may not be complete or fully applicable to all situations. If you are unable to resolve your issue, please contact the product manufacturer or an authorized service provider for official support.

Document generated by [ManualsFile](#)