

## Getting Started

### Appliance overview

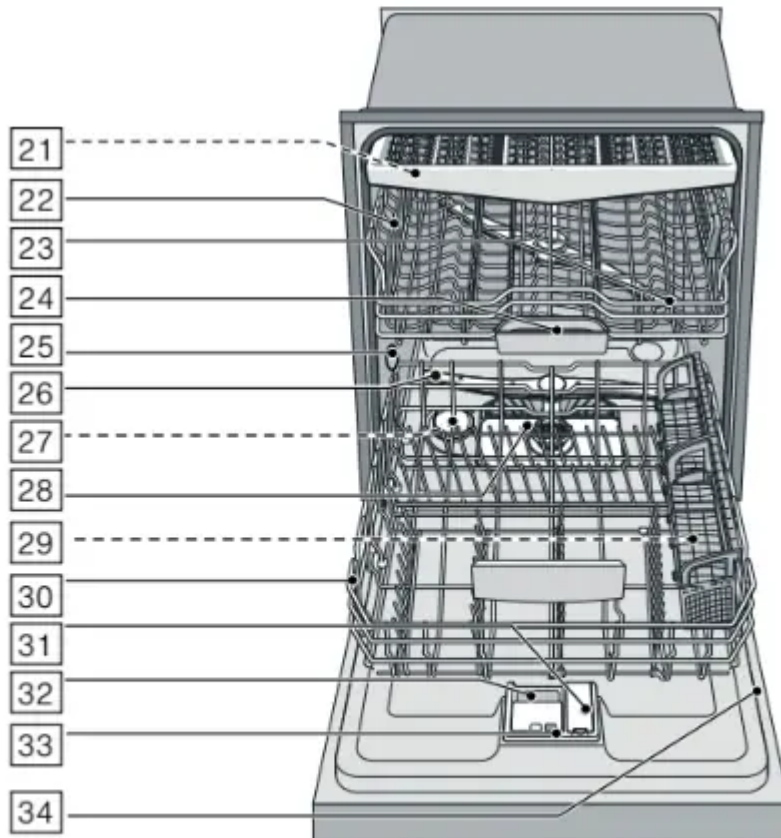

The dotted lines show optional features which may or may not be included with your dishwasher. The numbers stated below refer to the overview images on the previous page of this manual.

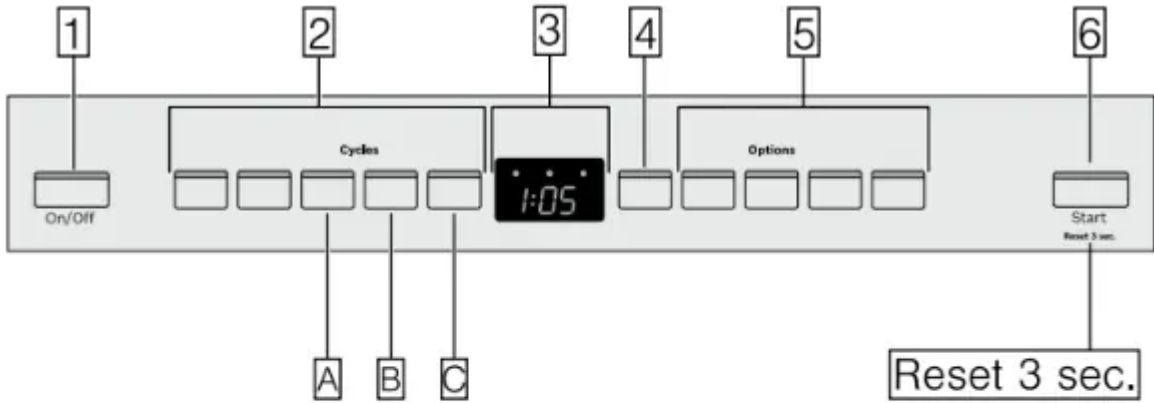

## Operating panel

1. On/Off button
2. Wash cycles
3. Digital display
4. Delay start button
5. Wash cycle options
6. Start button

**Note:** Some of the wash cycles and options will vary by model.

## Dishwasher interior components

20. Interior light \*
21. Third rack
22. Upper rack
23. Upper spray arm
24. Detergent tab tray
25. Vent hole
26. Zeolite outlet cover (zeolite container)
27. Lower spray arm
28. Dispenser for special salt \*
29. Filters
30. Silverware basket \*
31. Lower rack
32. Rinse aid dispenser
33. Detergent dispenser
34. Lock for detergent dispenser
35. Rating plate

\* optional feature which may or may not be included with your dishwasher.

## Display indicators

<b>0:00</b>	Cycle time remaining
<b>Add Rinse Aid</b>	Lights up when rinse aid is low
<b>Clean</b>	Lights up when dishes are clean
<b>Sanitize</b>	Lights up when sanitation requirements are met
<b>Extra dry *</b>	Lights up when intensive drying feature is set
<b>Water Tap *</b>	Lights up when a problem with water supply is detected

\* optional feature which may or may not be included with your dishwasher.

### Menu overview

The dishwasher has been preset with certain settings for your convenience. You can change these factory settings.

Use the function keys **A**, **B** and **C** to change the settings. See instructions → "  Operating the Dishwasher" on page 34

Setting	Factory setting	Description
<i>r</i> Rinse aid <i>r:00 - r:06</i>	<i>r:05</i>	Amount of rinse aid affects drying. When using Multitabs, select setting 0.
<i>d</i> Intensive drying* <i>d:00 - d:01</i>	<i>d:00 / Off</i>	Improved drying for glasses and plasticware.
<i>b</i> Cycle completion signal* <i>b:00 - b:03</i>	<i>b:02</i>	Signal sounds when wash cycle is complete.
<i>l</i> Infolight®* <i>l:00 - l:01</i>	<i>l:01 / On</i>	Light is projected to signal an active wash cycle.
<i>P</i> Auto power off <i>P:00 - P:02</i>	<i>P:01</i>	Dishwasher switches off automatically after wash cycle is complete.
<i>S</i> TimeLight®* <i>S:00, S:01</i>	<i>S:01 / On</i>	While a wash cycle is running, status information is projected onto the floor.

\* depending on the features of your dishwasher



## Rinse AidS

To achieve proper drying, always use a liquid rinse aid, even if your detergent contains a rinse aid or drying additive.

Note: The dishwasher indicates low rinse aid by turning on the Rinse Aid indicator. If this indicator lights up, you need to refill the rinse aid dispenser



by

following the directions below.

### **Adding rinse aid**

#### **NOTICE**

To avoid oversudsing or clogging, do not overfill the rinse aid dispenser 32. Wipe up any spills with a damp cloth.

1. Open the rinse aid dispenser

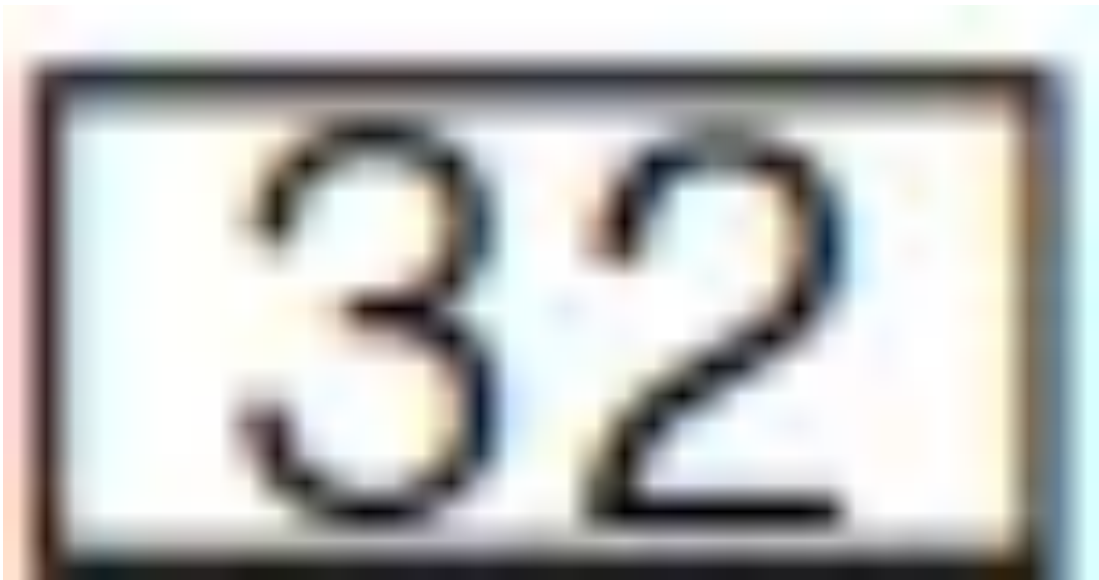

by

pressing on the latch of the lid and pull it open.

2. Add liquid rinse aid to the dispenser

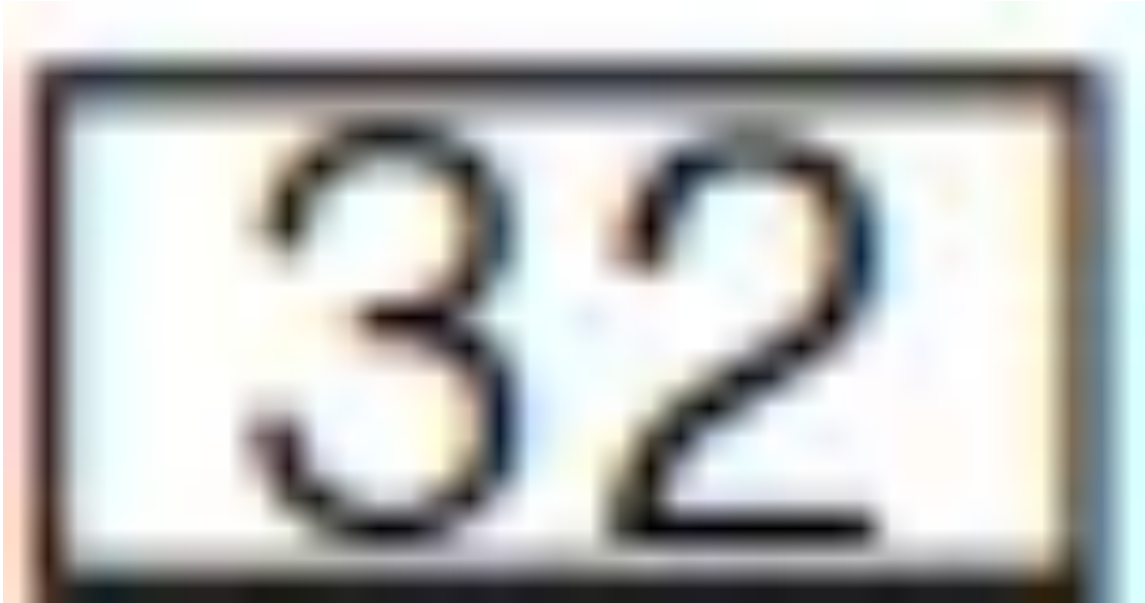

until it is full. Do not overfill. Avoid spilling into air vent hole.

3. Close the lid. Lid must be fully closed until it clicks in order to seal.

4. Wipe up any excess rinse aid that may have puddled when the dispenser reservoir is full.

The indicator light will go out a few moments after the dishwasher door is shut.

**Tip:** For easier pouring, remove lid from the rinse aid bottle.

**NOTICE**

Do not fill the rinse aid dispenser

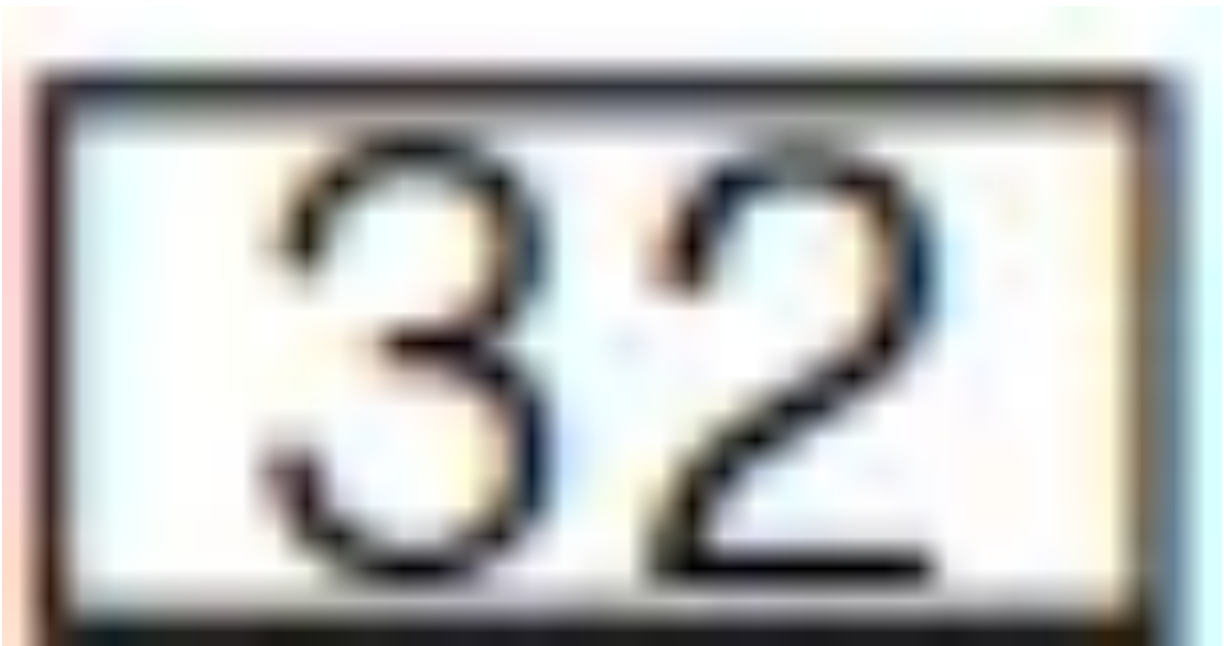

detergent. Doing so will damage the dishwasher.

with

## Setting the amount of rinse aid used

The amount of rinse aid dispensed can be set from 1 to 9. The factory setting is 5.

You should only change the setting if streaks remain on the dishes (lower the amount), or if dishes are not getting dry enough (increase the amount).

1. Open the door.
2. Press the On/Off button

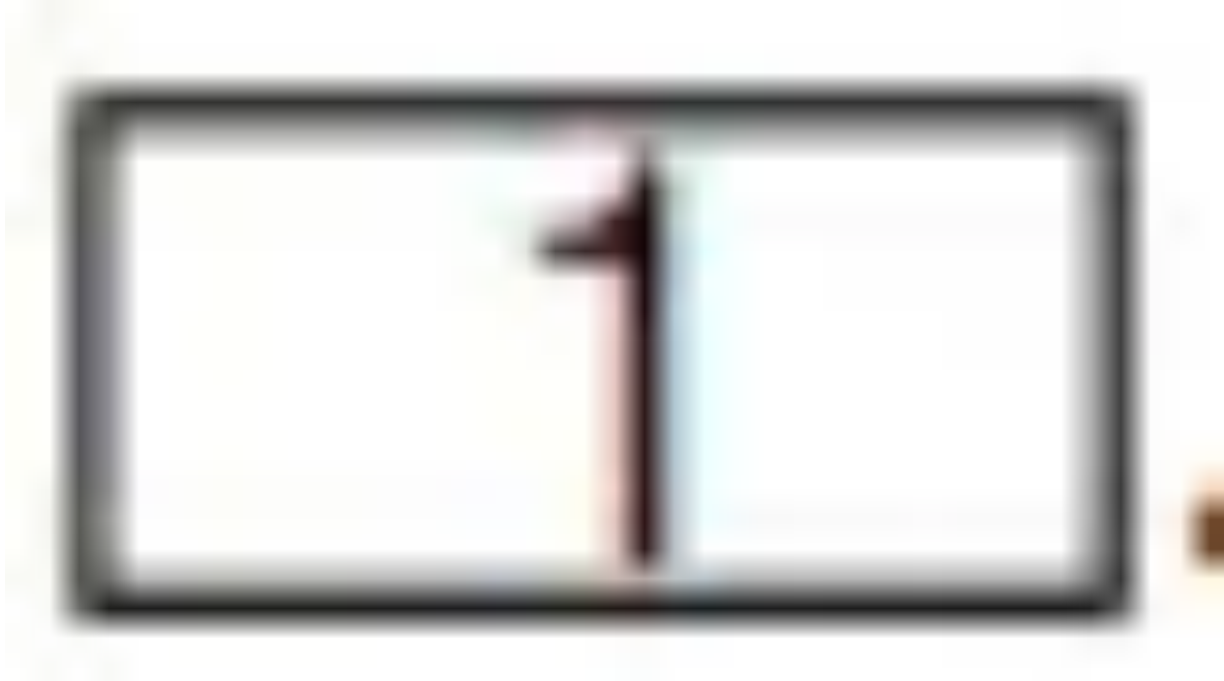

3. Hold down the function key

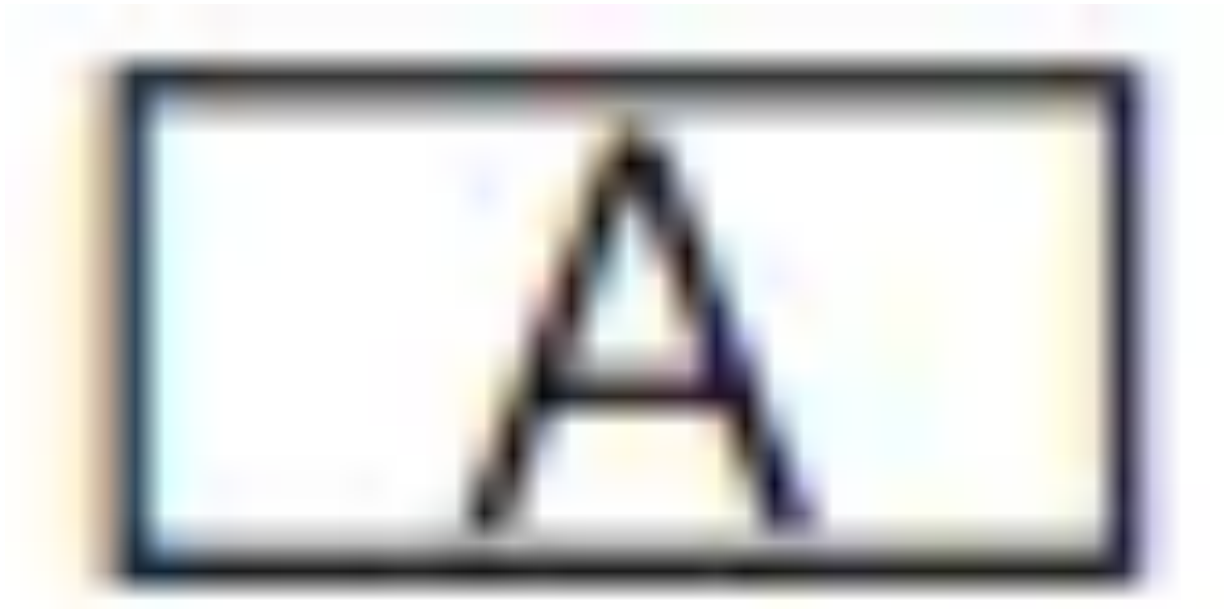

press the **Start** button

and

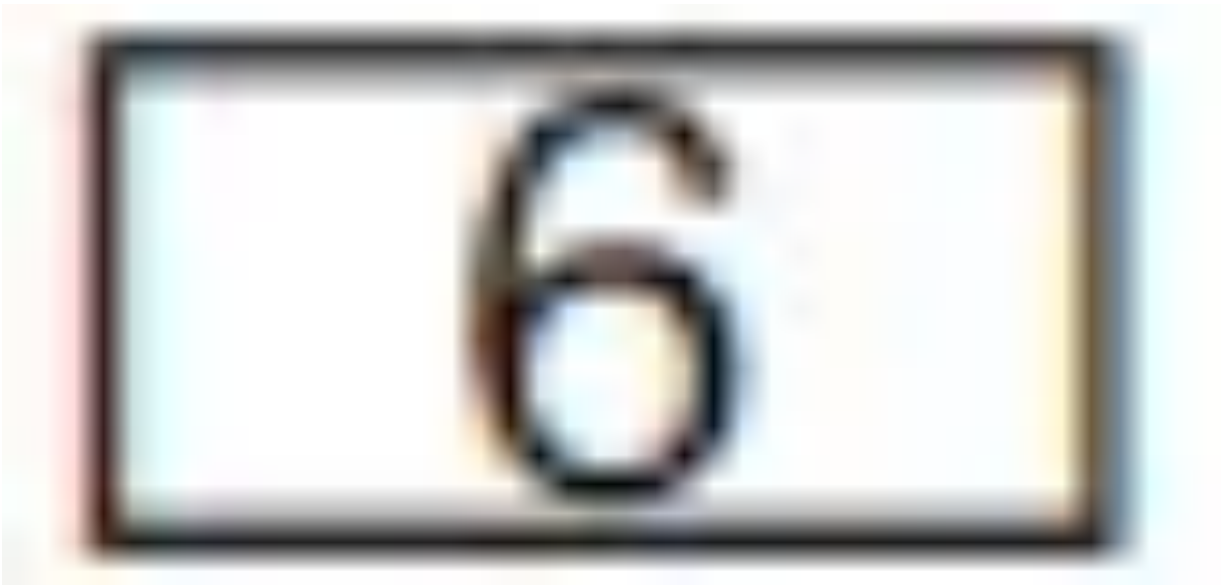

until

the display



indicates (x can be any number). Release both buttons.

4. Press the function key



until

the display



shows

5. Press the function key



to

select the desired setting.

6. Press the Start button

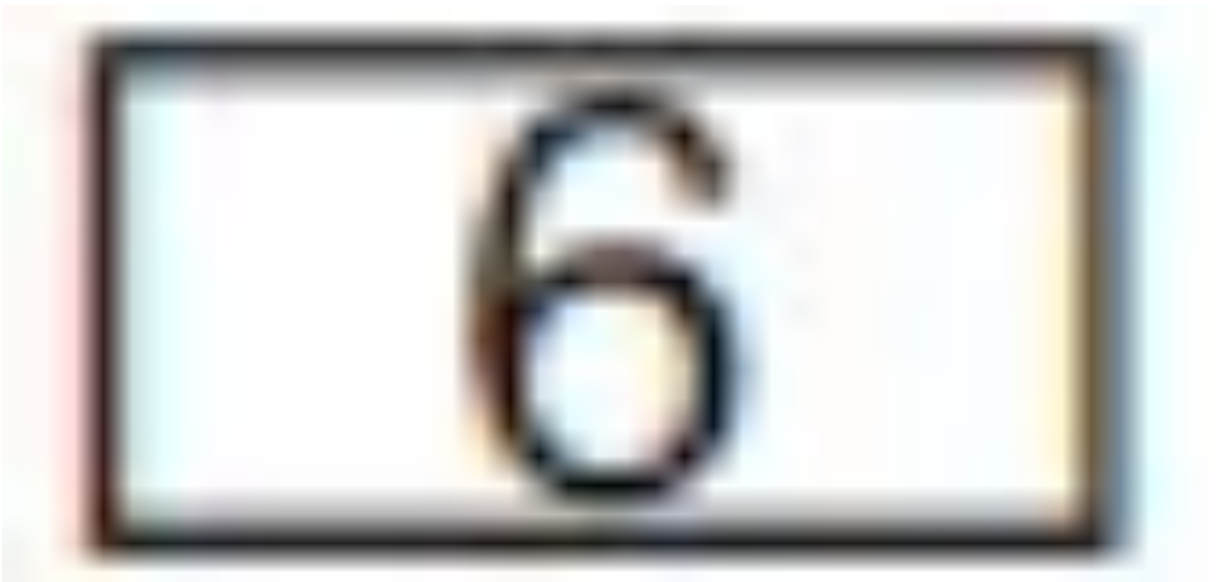

to

save the setting.

### **Turning off rinse aid indicator**

Proceed as described in the section “Setting the amount of rinse aid used” and set value to . The rinse aid indicator is now turned off.

#### **NOTICE**

Using no rinse aid or setting the dispenser to may result in longer cycle times consuming more energy and water. The higher temperatures and longer cycle times can damage fine china or glassware.



## Loading the Dishwasher

### Dishware material

#### Note:

Before using your dishwasher for the first time, check the information in this section. Some items are not dishwasher-safe and should be hand washed; others require special loading.

#### Recommended

##### Aluminum

- Colored anodized aluminum may fade over time. Minerals in your water may cause the aluminum to darken or spot. This can usually be removed with a soap-filled steel wool pad.

##### China, Crystal, Stoneware

- Some hand-painted utensils may discolor, fade or spot. Hand wash these utensils. Position fragile glassware so that it will not topple over or come in contact with other utensils during the wash cycle.

## **Glass**

- Make sure to use dishwasher-safe glass. Milk glass may discolor or become yellow.

## **Non-stick Coatings**

- Apply a light coating of vegetable oil to non-stick surfaces after drying.

## **Plastics**

- Make sure the plasticware is dishwasher-safe.

## **Stainless Steel, Sterling Silver and Silver Plates**

- Load these so they do not come in contact with other metals, stainless steel dishwasher tub walls or the inner door.

## **Not Recommended**

### **Acrylic**

- Cracking or small cracks throughout the acrylic, may occur.

### **Adhesive-Joined Pieces**

- Adhesives that join materials such as plastic, wood, bone, steel, copper, tin, etc. may loosen.

### **Bone-Handled Utensils**

- Handles may separate

### **Iron**

- Iron will rust. Hand wash and dry immediately.

### **Non-Dishware Items**

- Your dishwasher is intended for use in cleaning ONLY standard household dishware and kitchenware.

### **Pewter, Brass, Bronze**

- These items will tarnish. Hand wash and dry immediately.

### **Tin**

- Tin will stain. Hand wash and dry immediately

### **Wood**

- Wooden bowls, wooden utensils and utensils with wooden handles can crack, warp and lose their finish.

## Loading the racks

For best dishwashing results, observe the following when loading the dishwasher:

- Do not pre-wash items with loosely attached food soil.
- Remove all food particles, bones, toothpicks and excessive grease.
- Pre-treat items having burned-on, baked-on or starchy soils.
- Load dishes in the dishwasher racks so the insides of bowls, pots and pans are facing the spray arms.
- Avoid nesting and contact points between dishes.
- Separate items of dissimilar metals. Use care to not block movement of the spray arms.
- Only wash household dishware and kitchenware rated as dishwasher-safe.

Refer to the Dishware Materials section for more information about dishware suitability

### NOTICE

- To avoid dishwasher damage, do not load the dishwasher with paper products, plastic bags, packing materials or anything other than normal, dishwasher safe dishware and kitchenware

### Loading the upper rack

Ensure items do not protrude through the bottom of the racks and block the spray arms.

**Note:** When pushing the upper rack

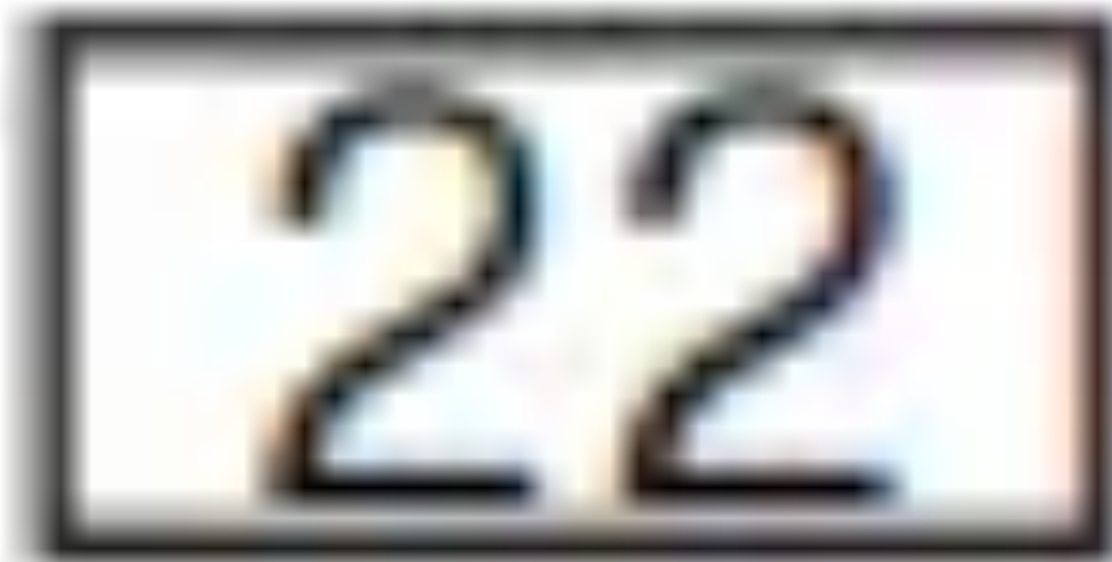

into

the dishwasher, push it until it stops against the back of the tub so the upper rack spray arm

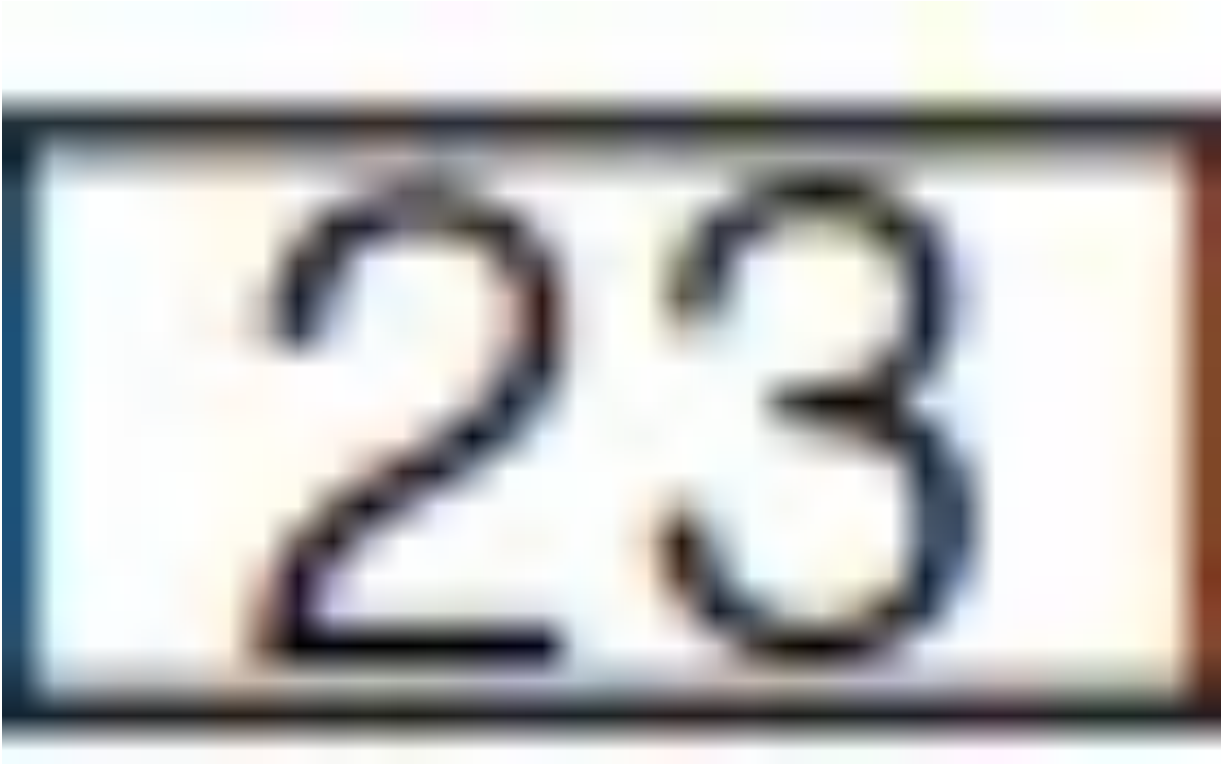

connects to the water supply at the back of the tub. Do not push racks in using the door.

#### **Loading the lower rack**

- Place large items in the lower rack

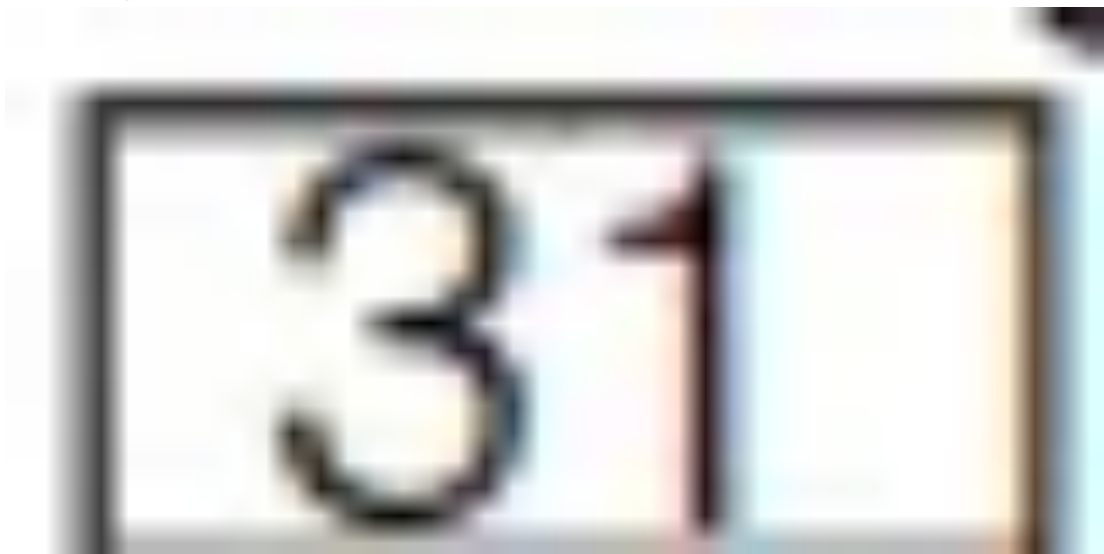

Load pots, pans and bowls upside down. Do not block the vent hole

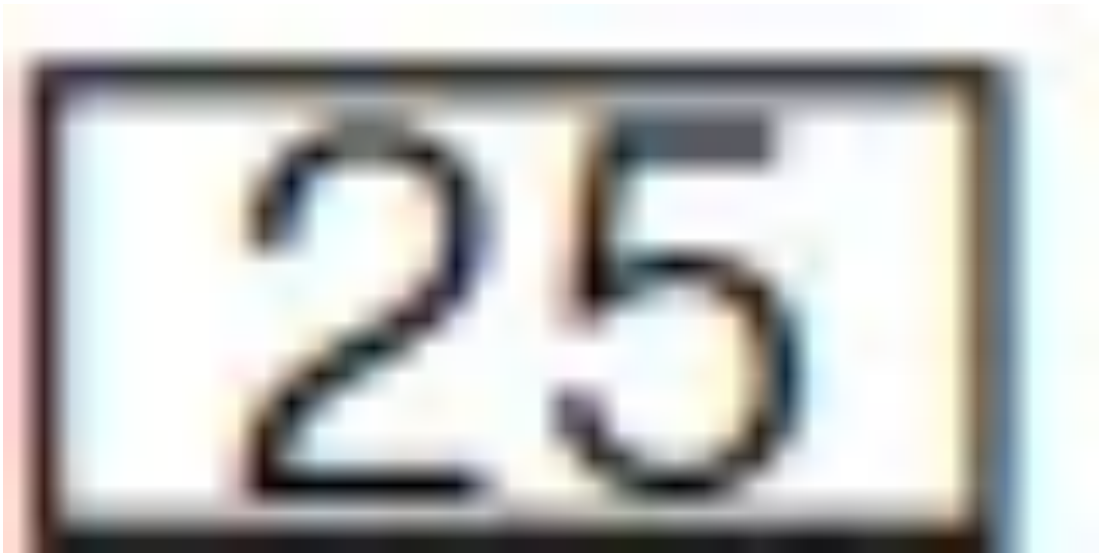

with tall baking sheets.

- Load these items on the right side of the dishwasher.

### **Loading patterns for lower rack**

**12 place setting suggested loading pattern**

**Alternate loading pattern**

**Alternate loading pattern with pots and pans**

For best results, load large items face down in the lower rack.

### **Loading patterns for upper rack**

**12 place setting suggested loading pattern, with third rack cutlery drawer \***

**12 place setting suggested loading with My Way Rack™ \***

**Alternate loading pattern**

**Alternate loading pattern with stemware**

Use supports to load stemware glasses in the upper rack.

\* optional feature which may or may not be included with your dishwasher.

### **Loading patterns for third rack**

**12 place setting suggested loading pattern \***

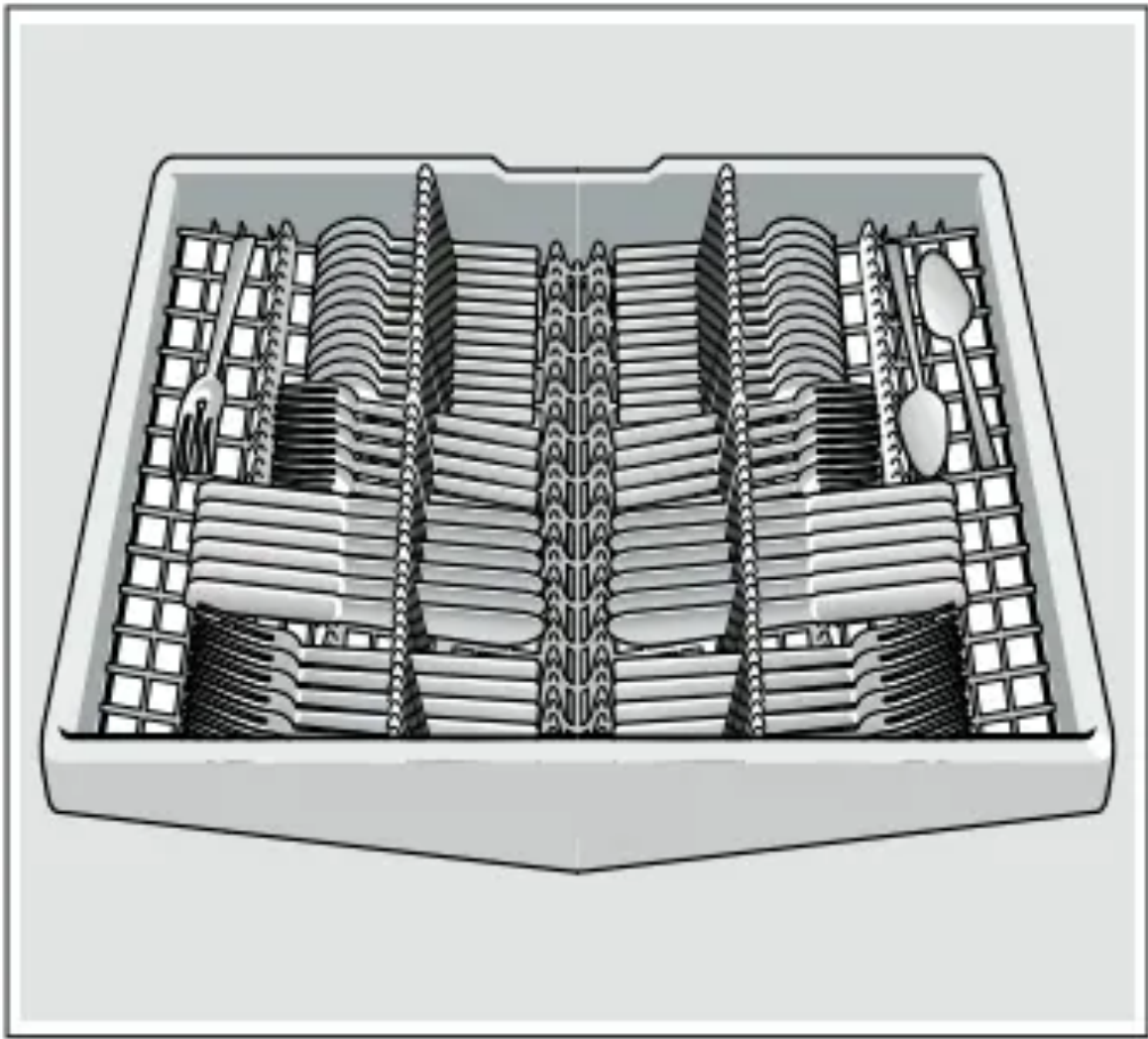

**My Way Rack™ \***

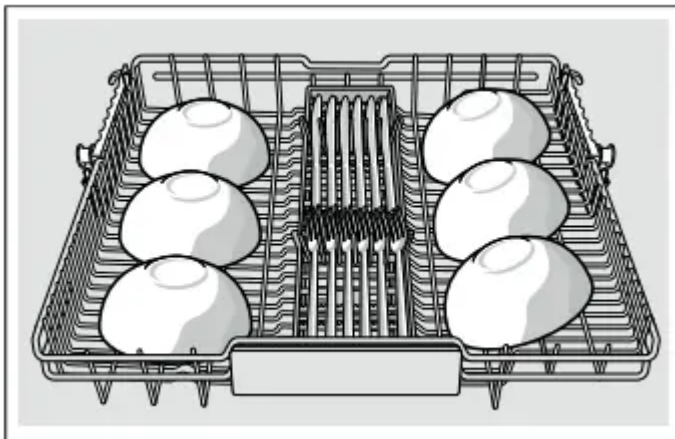

\* optional feature which may or may not be included with your dishwasher.



## Loading the silverware basket

Place knives and sharp utensils with their handles up and forks and spoons with their handles down. If large or oddly-shaped items are loaded in the silverware basket, be sure they do not nest together.



### WARNING

#### RISK OF INJURY!

The sharp points and edges of knives and other sharp utensils can cause serious injury. Load knives and other sharp utensils with edges down. Do not allow children to handle or play near knives and sharp utensils.

#### Silverware basket\*

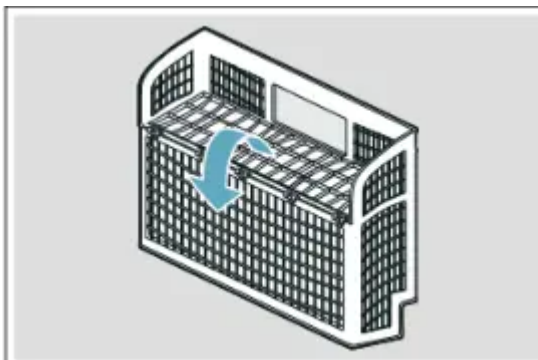

**Note:** The silverware basket lid may also be folded downward in order to leave the basket open.

\* optional feature which may or may not be included with your dishwasher.

### **The Double Flex silverware basket \***

This basket splits along its length, resulting in two halves that may be placed in a variety of positions in the lower rack 31, greatly increasing the lower rack's loading versatility. The basket snaps together either side by side or back to back.

To split the Double Flex silverware basket:

Grasp the basket and slide the two halves in opposite directions and then pull the two halves apart.

#### **Side by side**

#### **Back to back**

To assemble the Double Flex silverware basket:

Hold the two halves side by side or back to back, so that the tab on one basket can slip into the notch on the other basket. Push the two halves in opposite directions until they click.

**Note:** The silverware basket lid may also be folded downward in order to leave the basket open.

\* optional feature which may or may not be included with your dishwasher.

### **Suggested loading patterns**



1. Salad fork
2. Teaspoon
3. Dinner fork
4. Knife
5. Tablespoon
6. Serving spoon
7. Serving fork

### **Silverware basket**

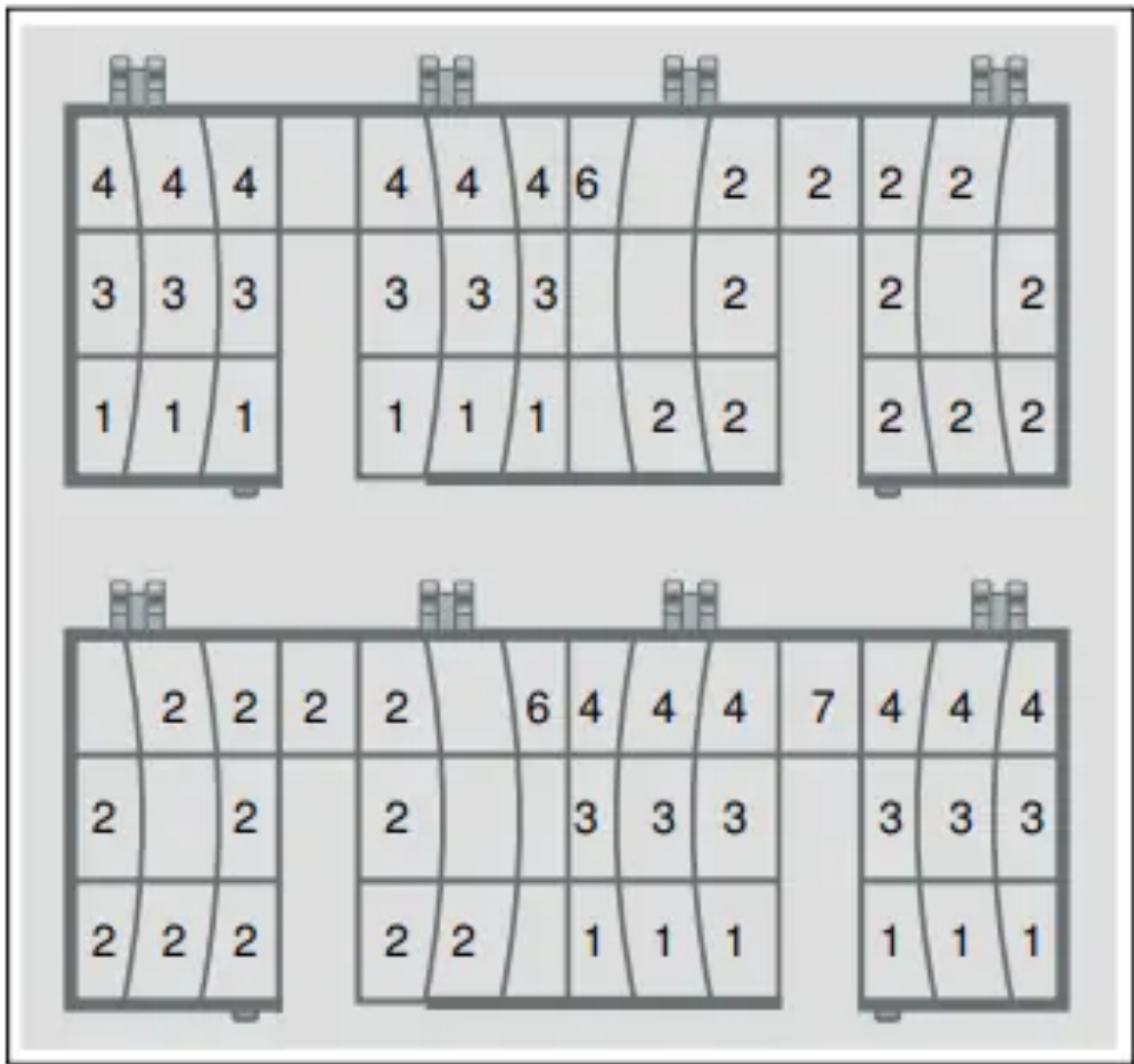

Double Flex silverware basket



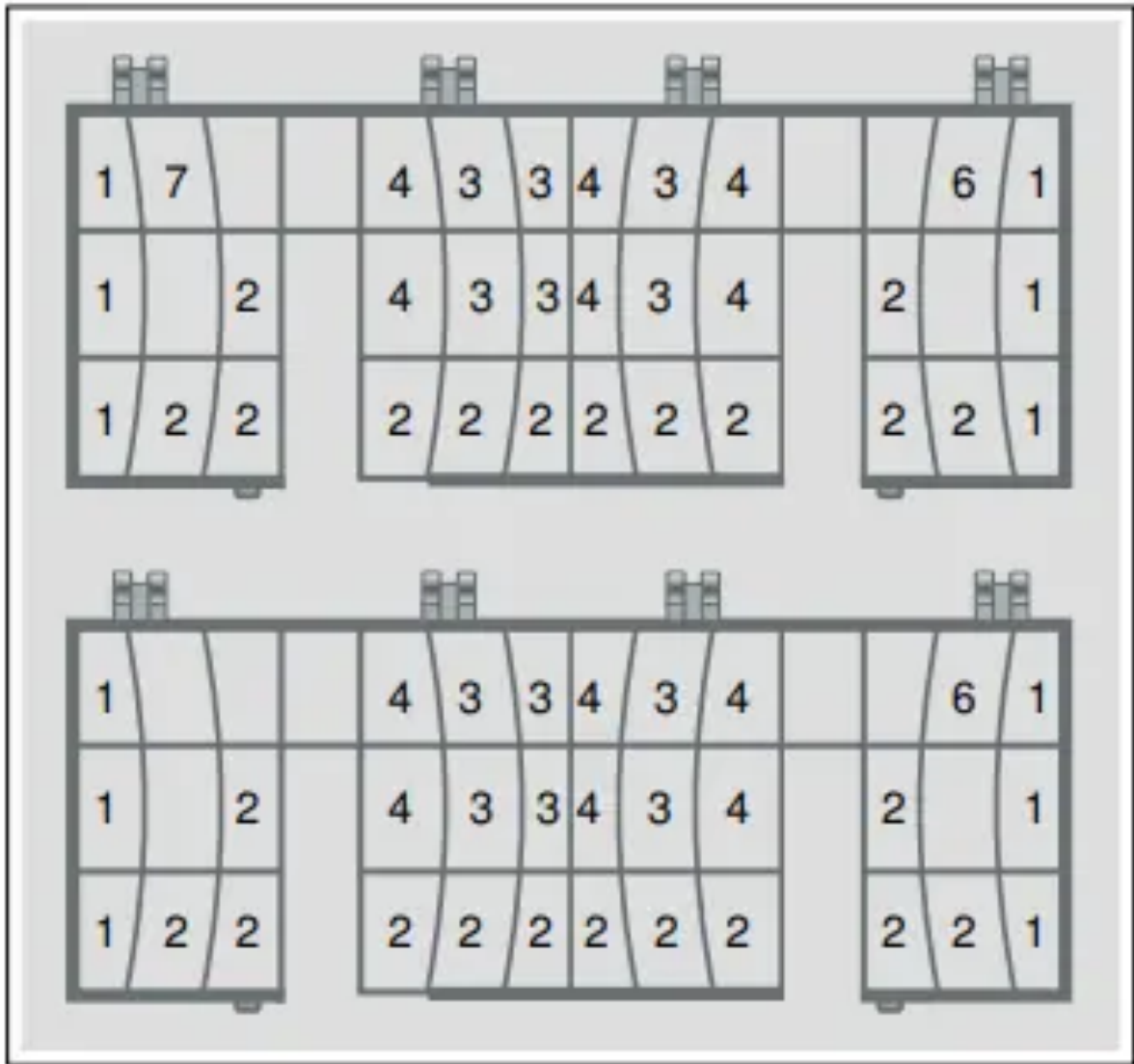

## Unloading the dishwasher

### CAUTION

Dishes can be very hot immediately after cycle ends. Open the door slightly and allow dishes to cool for a few minutes before unloading.

**Note:** Dishes are more likely to chip when unloading before cooling.

When unloading the dishwasher, to prevent water from dripping onto dry dishes, unload the lower

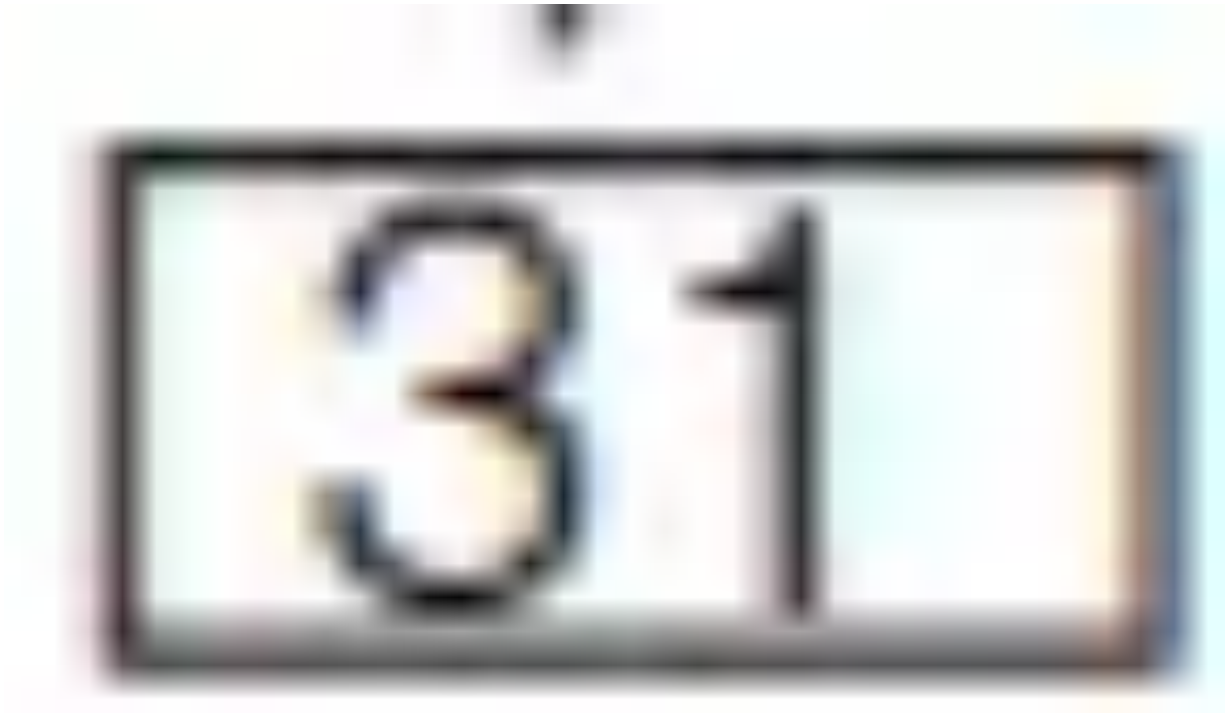

rack

first. Next, unload the silverware basket



followed by the upper rack

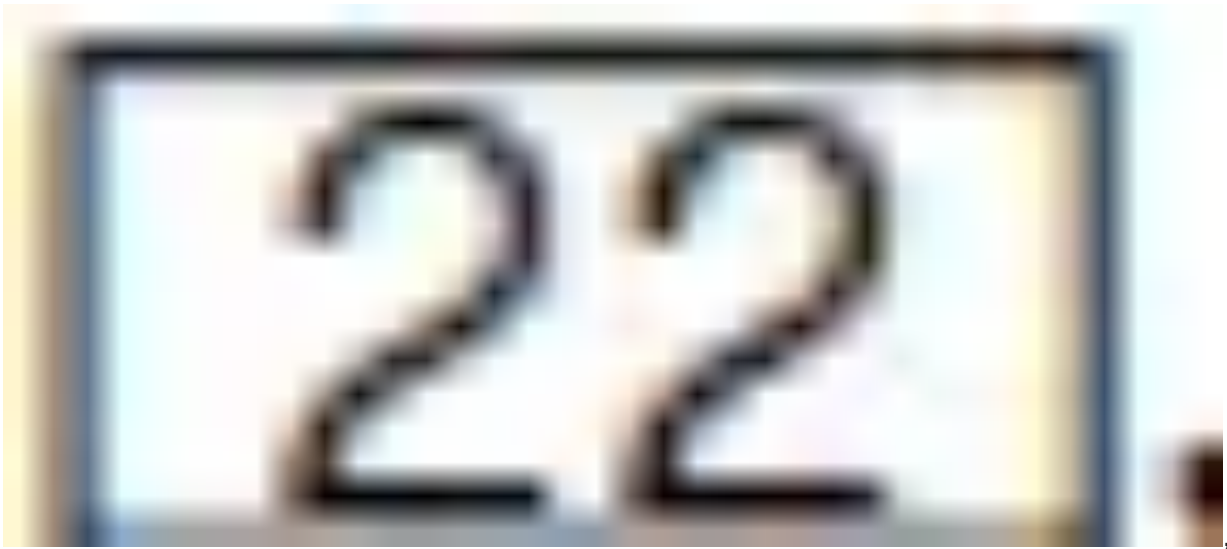

and then the third rack (if equipped).

### **Adjusting the height of the rack**

If desired, the height of the upper rack

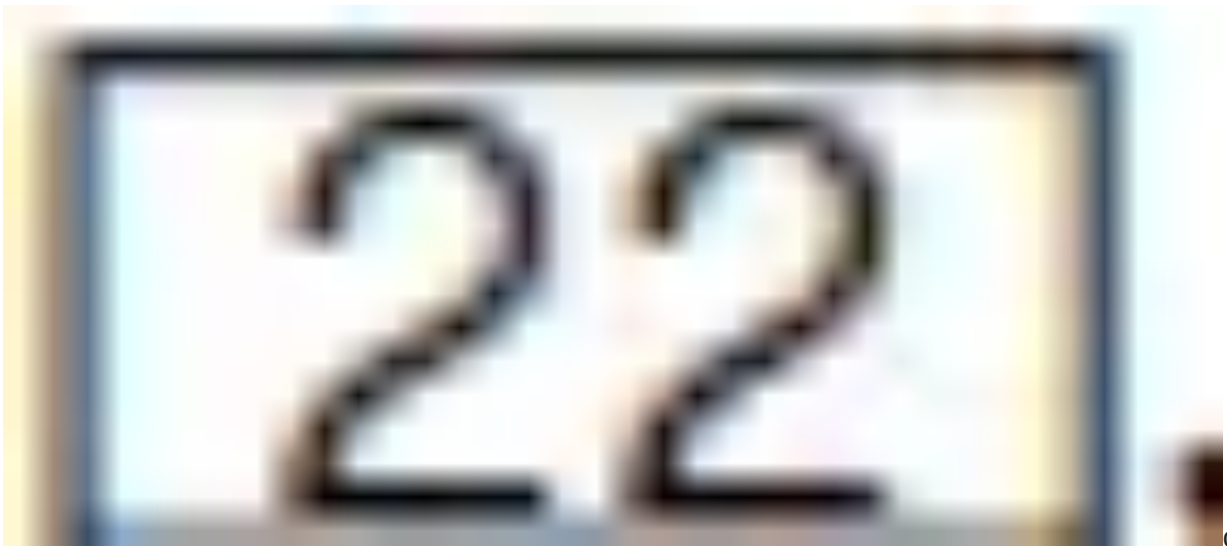

can

be adjusted to create more space for taller utensils either in the upper or lower rack.

<b>With silverware basket</b>	<b>Upper rack</b>	<b>Lower rack</b>
Setting 1 max. ø	9.4 in (24 cm)	12.6 in (32 cm)
Setting 2 max. ø	10.4 in (26.5 cm)	11.8 in (30 cm)
Setting 3 max. ø	11.4 in (29 cm)	10.6 in (27 cm)

<b>With third rack</b>	<b>Upper rack</b>	<b>Lower rack</b>
Setting 1 max. ø	7 in (18 cm)	12.6 in (32 cm)
Setting 2 max. ø	8 in (20.5 cm)	11.8 in (30 cm)
Setting 3 max. ø	9 in (23 cm)	10.6 in (27 cm)

Arrange large plates up to a diameter of 12.6 in (32 cm) in the lower basket

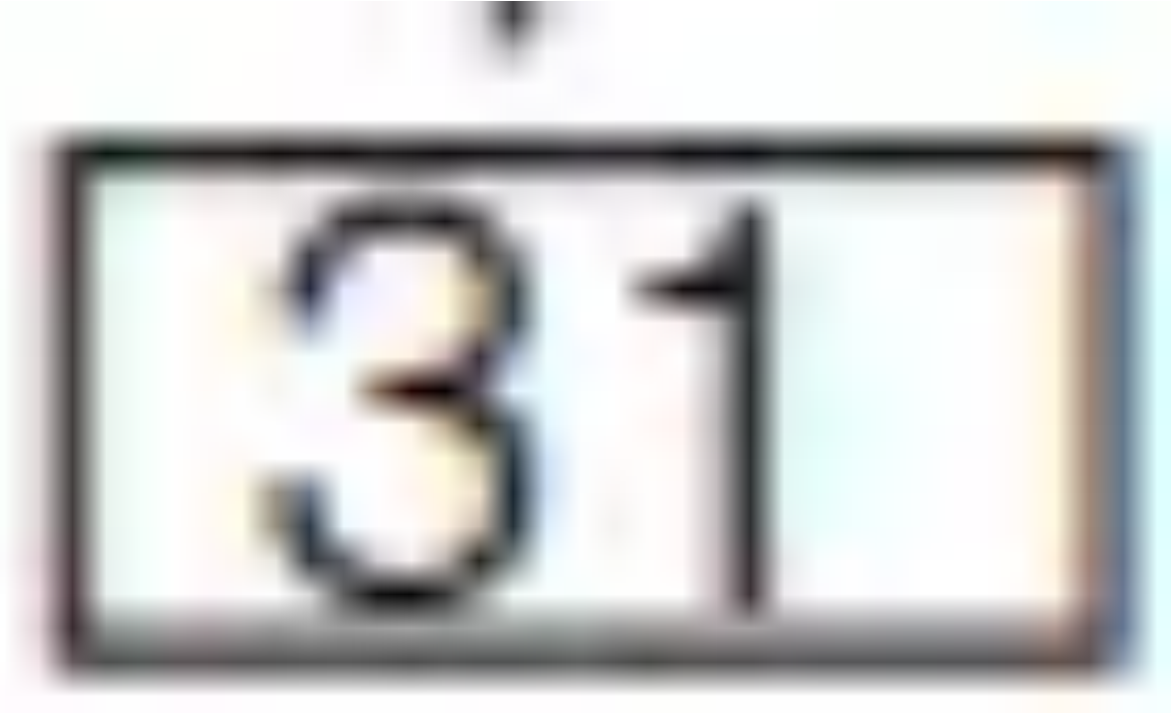

as

illustrated.

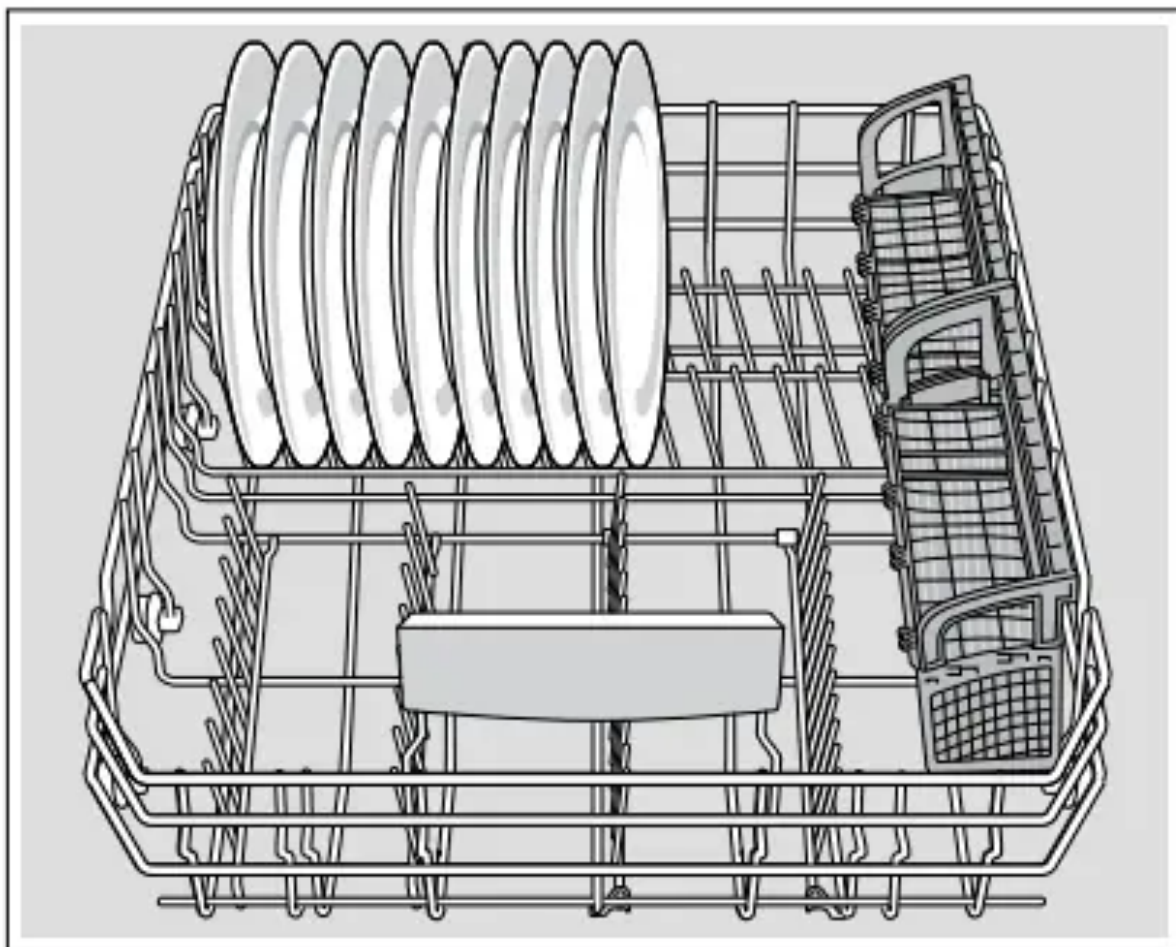

## RackMatic®

The height of the upper rack

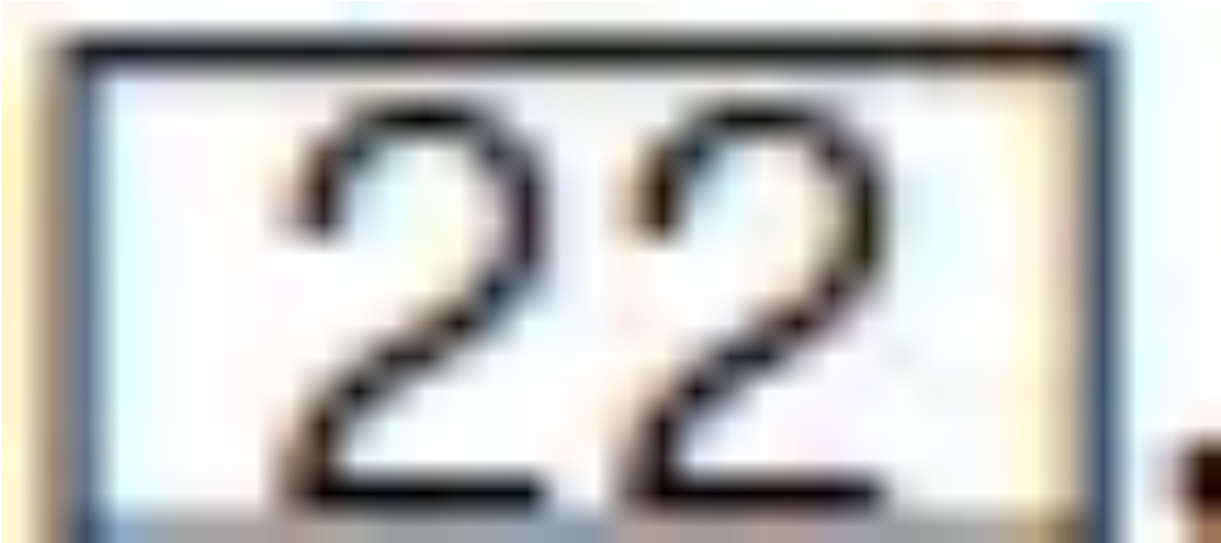

can

be adjusted in 3 steps to create more space.

Pull the upper rack out of the dishwasher until it stops.

1. To lower the rack, push the
2. RackMatic® lever inward.
3. To raise the rack, hold the basket on the sides of the upper rack and lift it up.

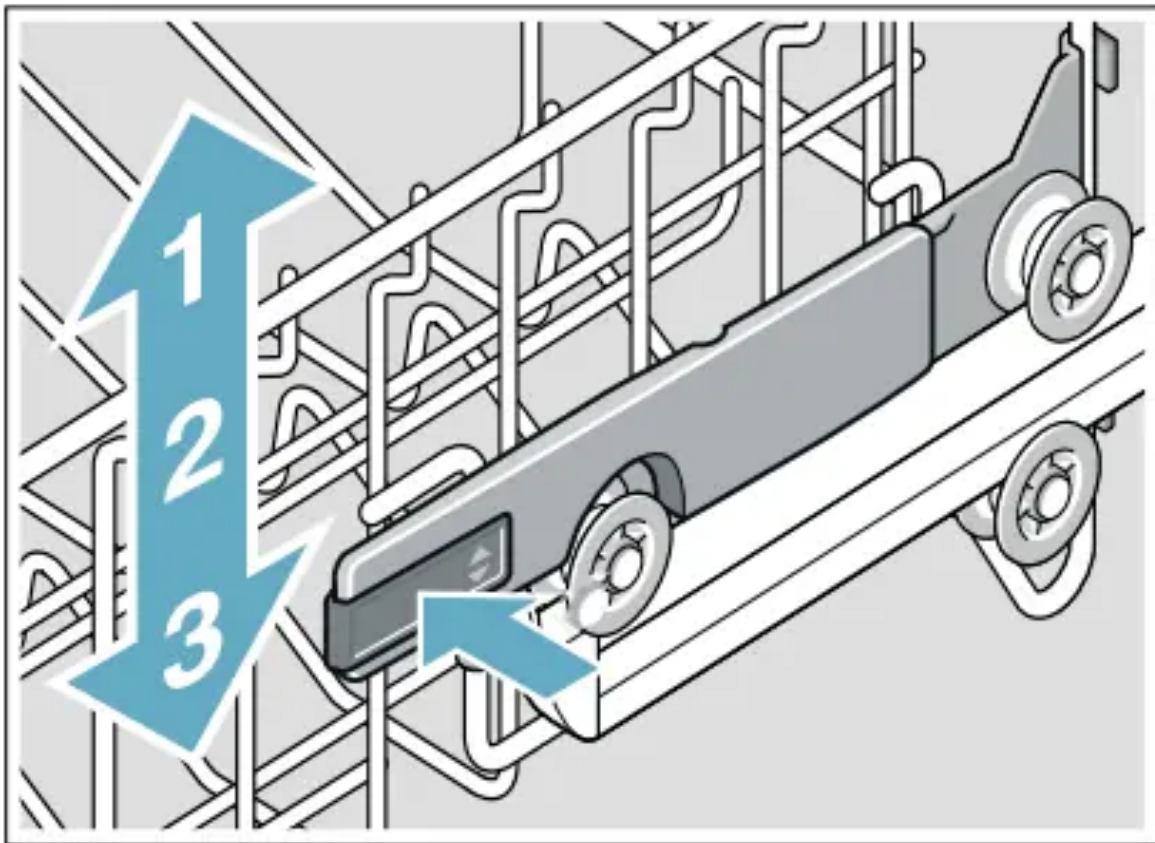

**Note:** Check spray arm for clearance after adjustment.

## Rack accessories

### Flip tines

The upper and lower rack are fitted with flip tines that can be folded down depending on what you may need to load in the rack.

Lower rack flip tines: To fold down, pull flip tine gently forward and release it from the notch. Push the flip tine downward. To fold up, push flip tines into an upright position until the holder engages in the notch.

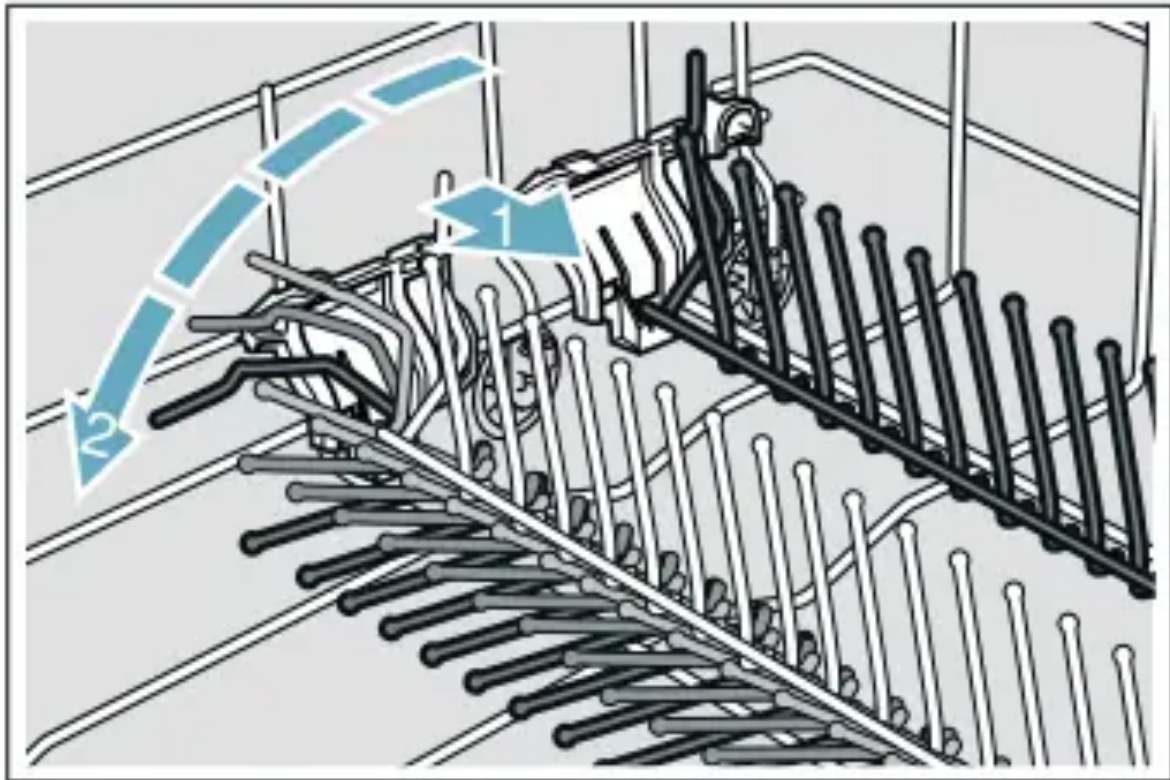

Upper rack flip tines: To fold down, push flip tines downward with gentle pressure. To fold up, push flip tines into an upright position until the holder engages in the notch.

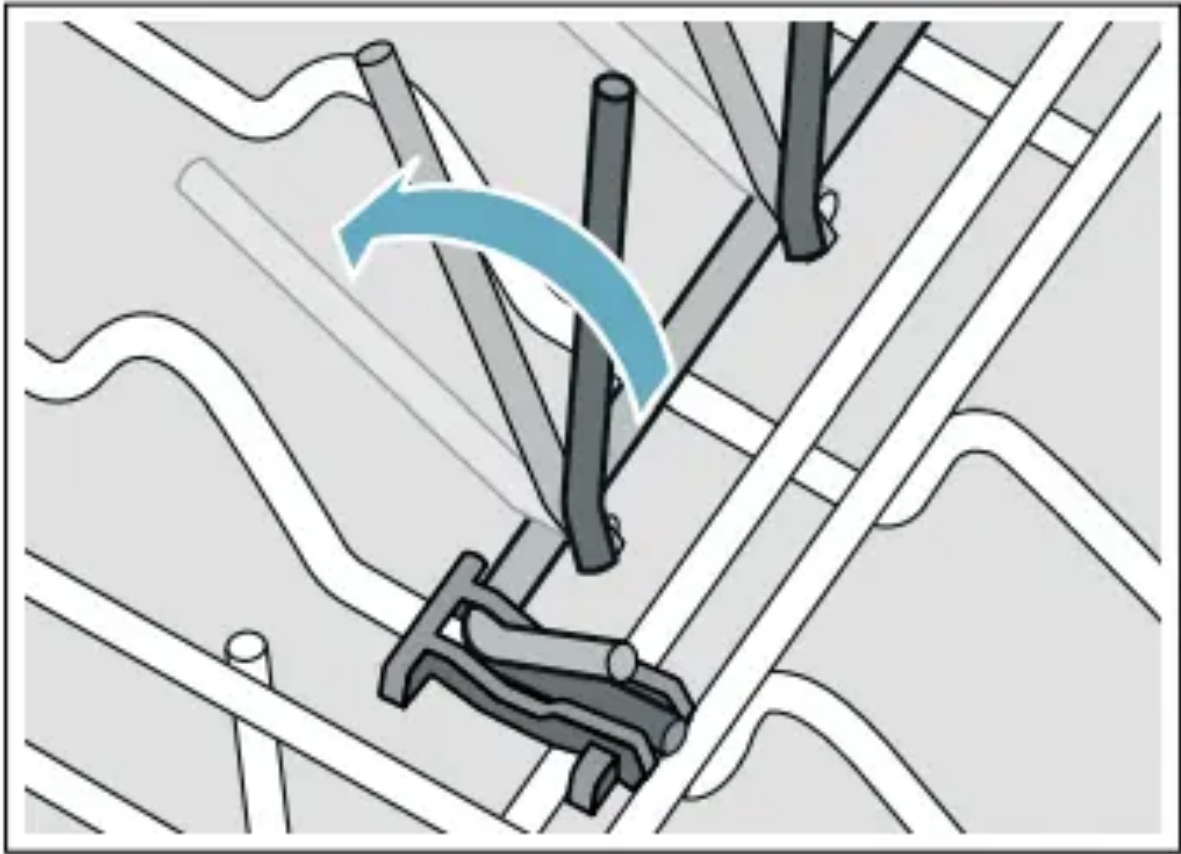

**My Way Rack™ \***

This third rack is ideal for small bowls, spatulas and other oversized tools for improved cleaning and easier loading and unloading. Arrange cutlery in cutlery insert.

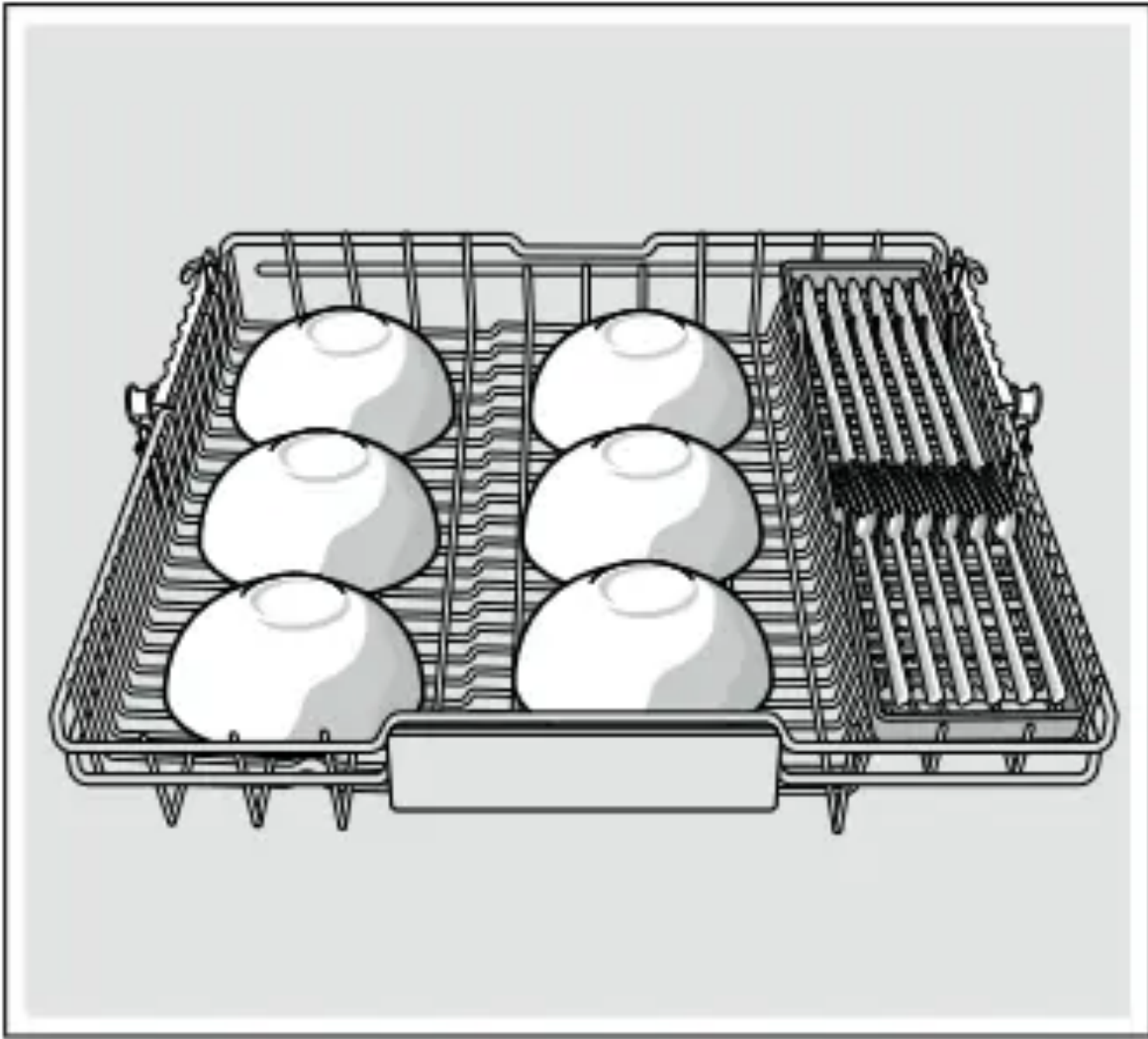

\* optional feature which may or may not be included with your dishwasher..

### Cup shelves

The cup shelves and the space underneath them can be used for small cups or for larger serving utensils. They also serve as stemware supports. → "Loading patterns for upper rack" on page 17

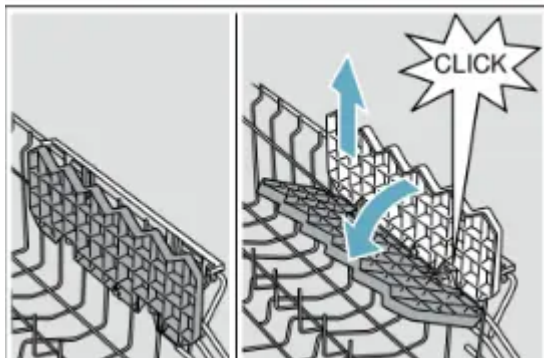

### Extra tall item sprinkler\*

If an item is too tall to be placed in the lower rack

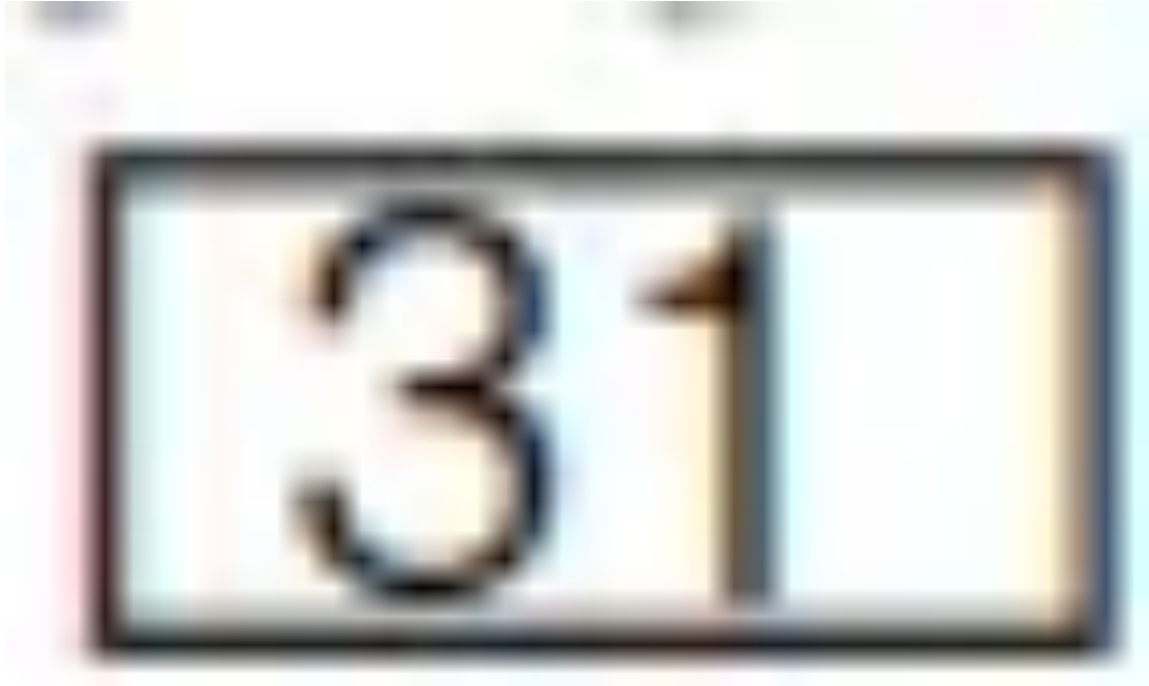

even with the upper rack

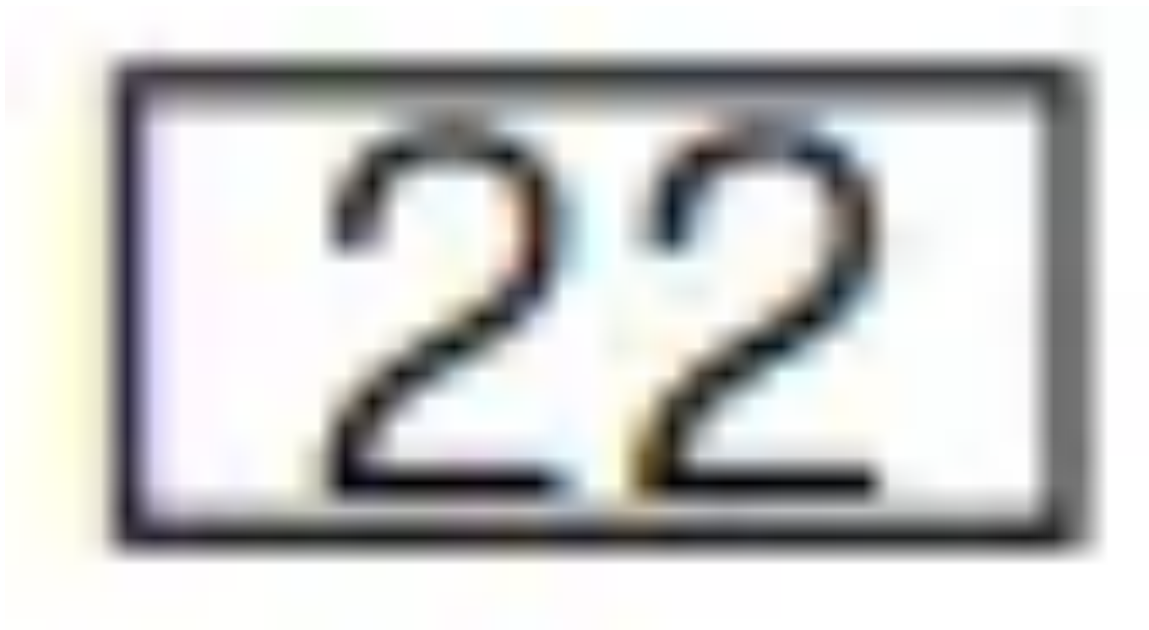

the raised position, remove the empty upper rack

in



by pulling it out of the dishwasher until it stops. Pull the front of the rack upward and outward until the rack will not slide out anymore. Then lift it up and away from the dishwasher, until the rollers are completely free of the roller guides **(A)**.

Set the upper rack



aside and push the roller guides **(A)** back into the dishwasher. Insert the extra tall item sprinkler **(B)** into the upper rack spray outlet **(C)** and turn the sprinkler clockwise to lock into position.

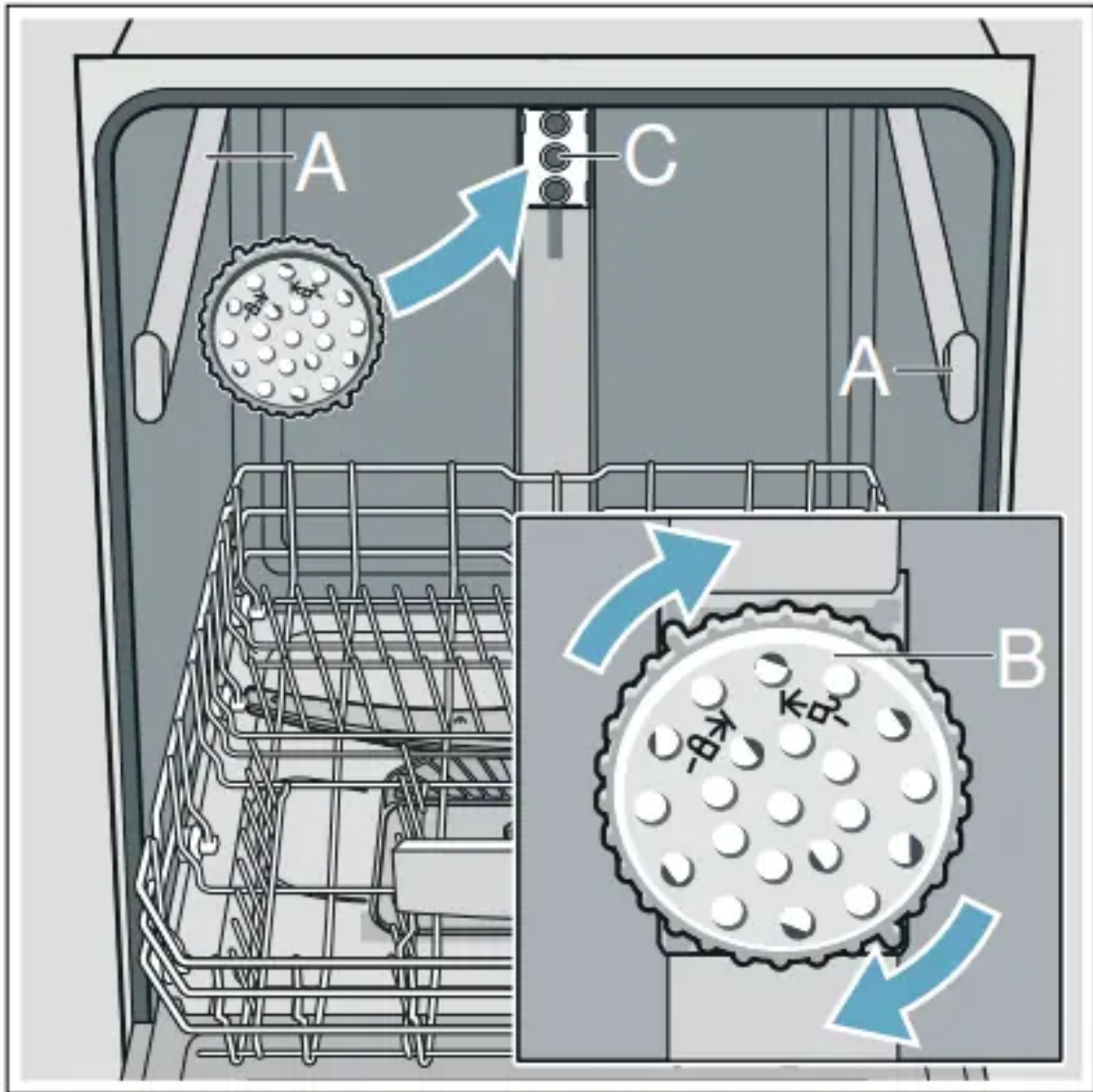

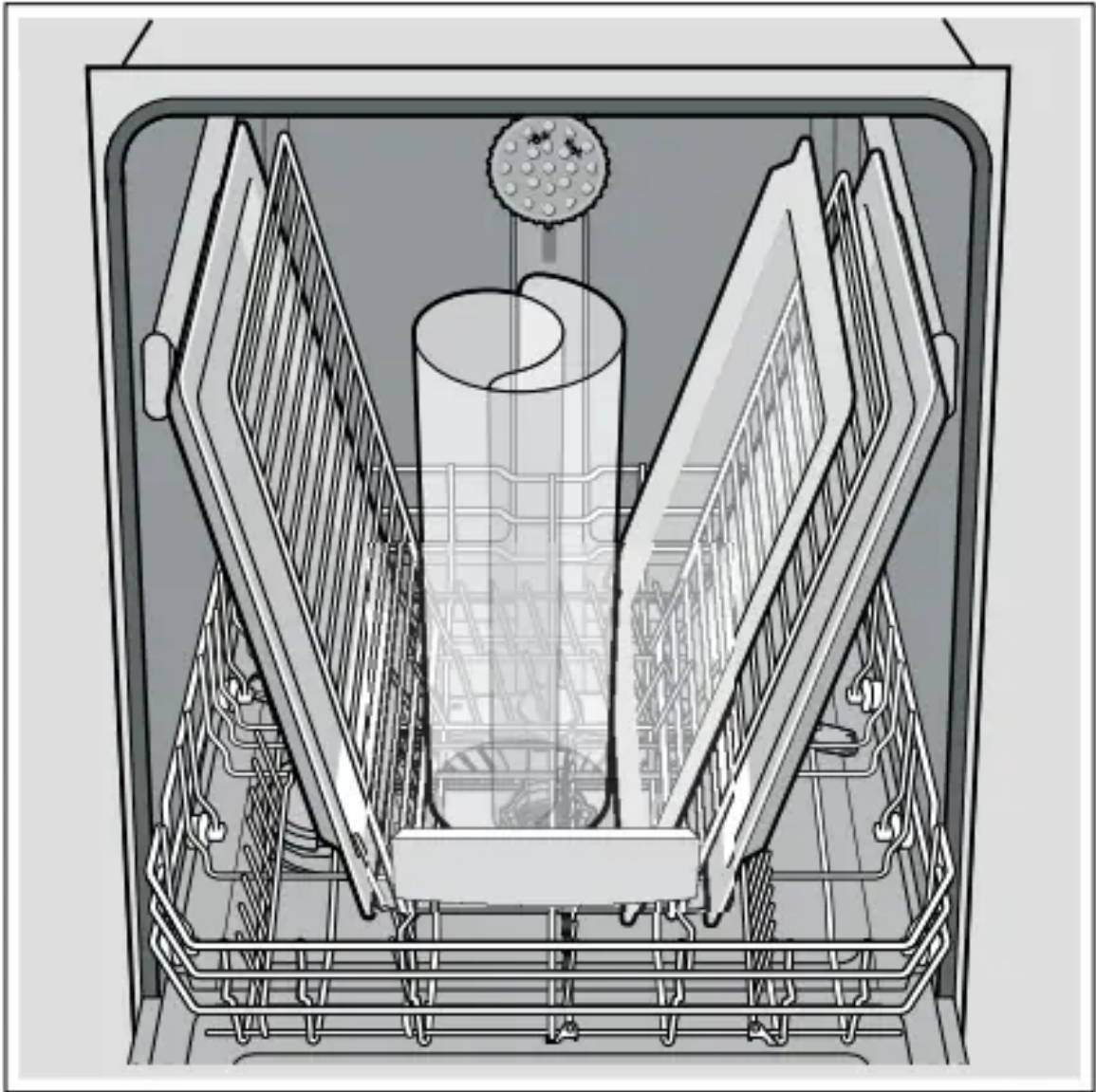

**Note:** Keep the vent hole

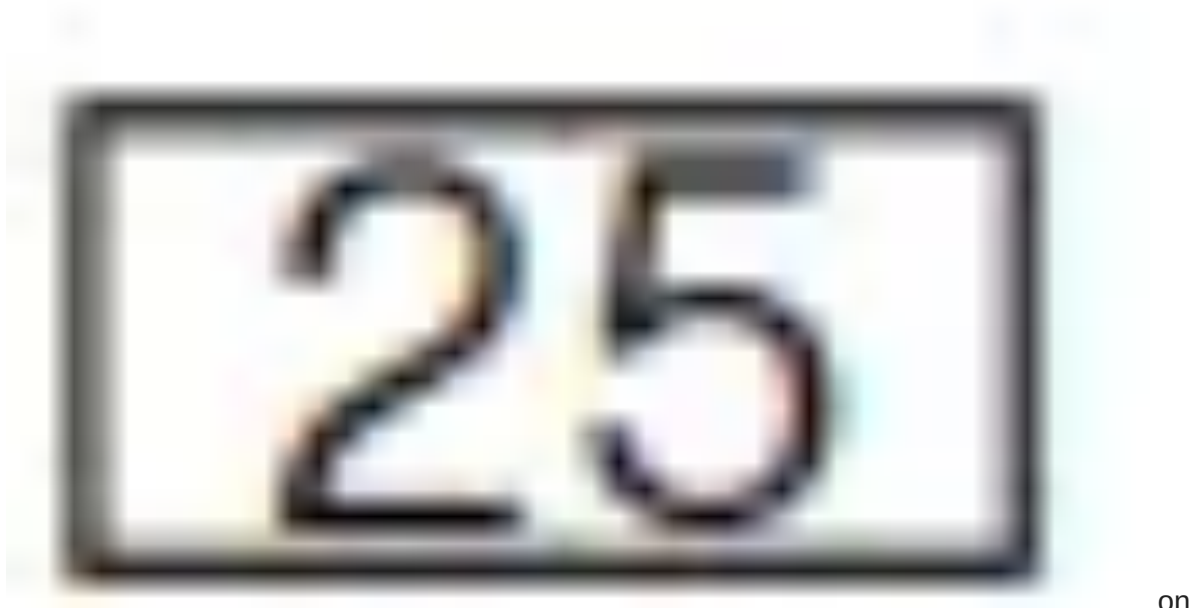

on the tub's left side clear by placing tall items such as plastic cutting boards and tall baking sheets on the lower rack's right side or center.

**NOTICE**

To avoid dishwasher damage, do not reinstall the upper rack **22** without removing the extra tall item sprinkler **(B)**.

\* optional feature which may or may not be included with your dishwasher.

**Removing/Installing third rack**



**Removing third rack **21****

1. Pull out third rack all the way (1).

2. Lift upper rollers over the stopper hooks of both rails (2).
3. Pull third rack out forward and upward so that the holding hooks and the lower rollers of the rack slide over the stopper hooks of both rails (3).

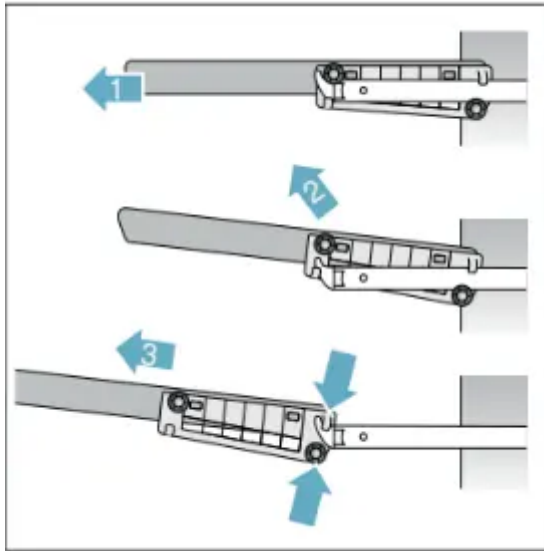

#### Installing third rack 21

1. Pull out third rack rails all the way (1).
2. Insert third rack at an angle. Make sure that the stopper hooks of both rails slide in between the holding hooks and the lower rollers of the third rack (2).
3. Slide third rack in and lift the upper rollers over the front stopper hooks of both rails (3).
4. Push in third rack (4).

#### Removing/Installing upper rack with Rackmatic®

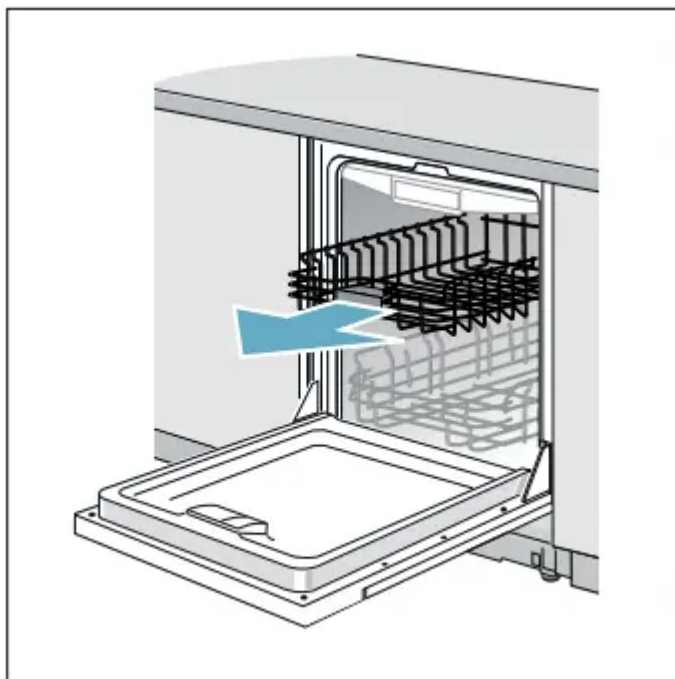

## Removing upper rack 22

1. Pull out upper rack all the way (1).
2. Lift front rollers over the stopper hook of the rail (2).
3. Pull out upper rack forwards and upwards so that the upper and lower rollers of the rack slide over the stopper hooks of both rails (3).

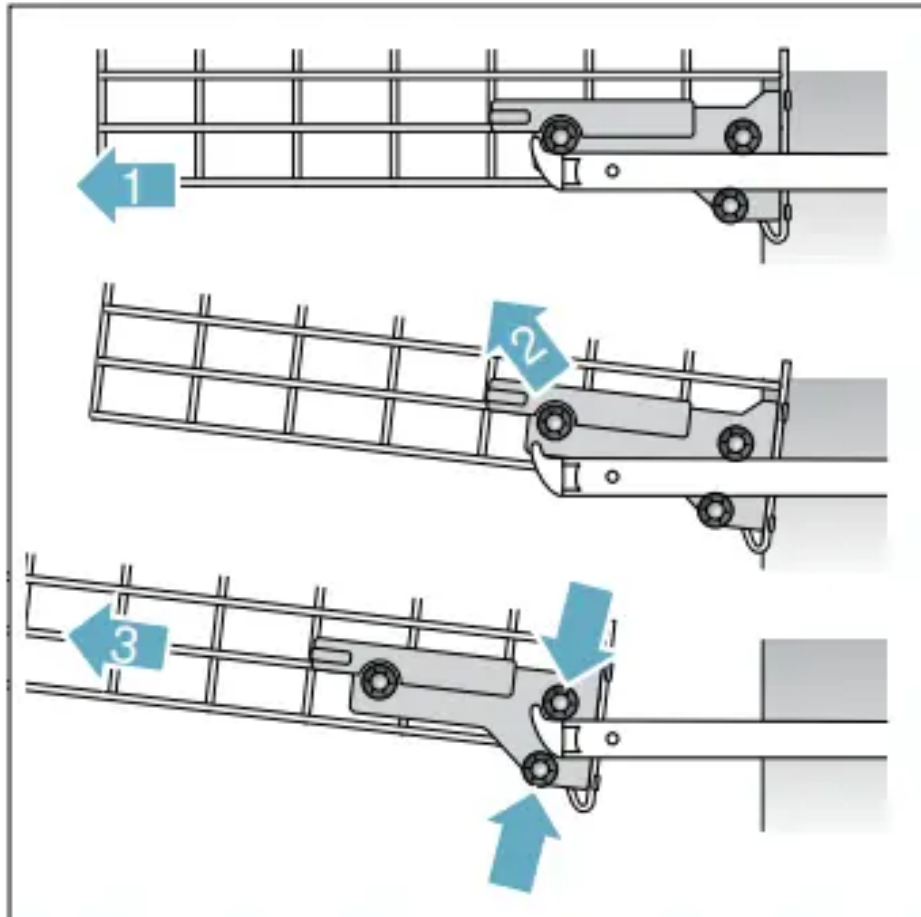

## Installing upper rack 22

1. Pull out upper rack rails all the way (1).
2. Insert upper rack at an angle.
3. Make sure that the stopper hooks of both rails slide in between the upper and lower rollers on the rear side of the rack (2).
4. Slide upper rack in and lift the upper rollers over the front stopper hooks of both rails (3).
5. Push in upper rack (4).

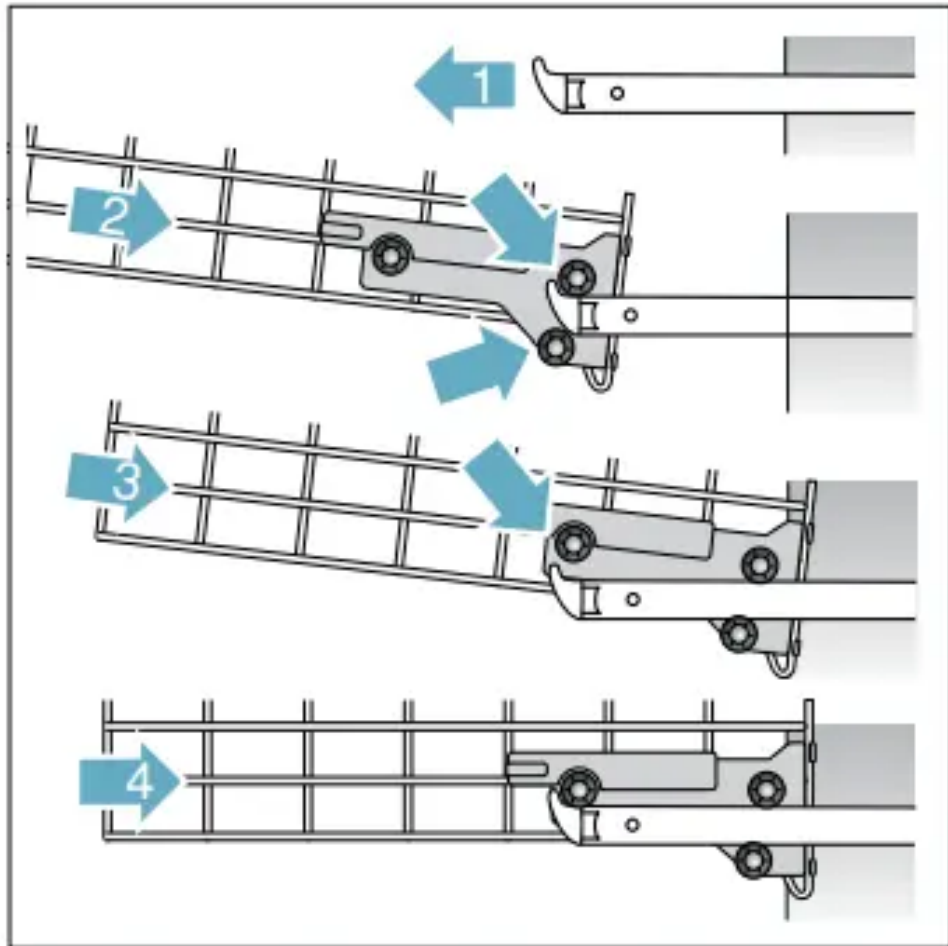

## Detergent

Use only detergent specifically designed for dishwashers. For best results, use fresh powdered dishwashing detergent or detergent tabs.

### **NOTICE**

To avoid damage to dishwasher or dishware:

- Do not use hand dishwashing products in your dishwasher.
- Do not use too much detergent if your water is soft. Using too much detergent with soft water may cause etching in glassware and fine china.
- To best protect glassware, use a wash cycle with low temperatures or a specific glass-care cycle depending on the model) and use a detergent that includes etch protection.

This dishwasher uses less water than most, therefore, less detergent is required. With soft water, tablespoon (15 ml) of detergent will clean most loads. The detergent dispenser cup has lines that measure detergent to 1 tablespoon (15 ml) and 1.75 tablespoons (25 ml). tablespoons (45 ml) of detergent will completely fill the detergent dispenser.

**Note:** If you do not know the hardness of your water supply, use ml of detergent. Increase the amount if necessary to the least amount required to get your kitchenware clean.

Use the measuring lines in the detergent dispenser cup as a guide to measure the amount of detergent recommended in the following table.

Wash Cycle	Hard Water/ Heavy Soil	Medium Water/ Medium Soil	Soft Water/ Little Soil
Heavy	3 tbsp (45 ml)	3 tbsp (45 ml)	1.75 - 3 tbsp (25 - 45 ml)
Auto	1.75 - 3 tbsp (25 - 45 ml)	1.75 tbsp (25 ml)	1 - 1.75 tbsp (15 - 25 ml)
Glass	1.75 - 3 tbsp (25 - 45 ml)	1 - 1.75 tbsp (15 - 25 ml)	1 tbsp (15 ml)
Eco	1.75 - 3 tbsp (25 - 45 ml)	1 - 1.75 tbsp (15 - 25 ml)	1 tbsp (15 ml)
Normal	1.75 - 3 tbsp (25 - 45 ml)	1.75 tbsp (25 ml)	1 - 1.75 tbsp (15 - 25 ml)
Speed60®	1.75 tbsp (25 ml)	1 - 1.75 tbsp (15 - 25 ml)	1 tbsp (15 ml)
Express	1.75 tbsp (25 ml)	1 - 1.75 tbsp (15 - 25 ml)	1 tbsp (15 ml)
Rinse	none	none	none

### Adding detergent

1. If the detergent dispenser

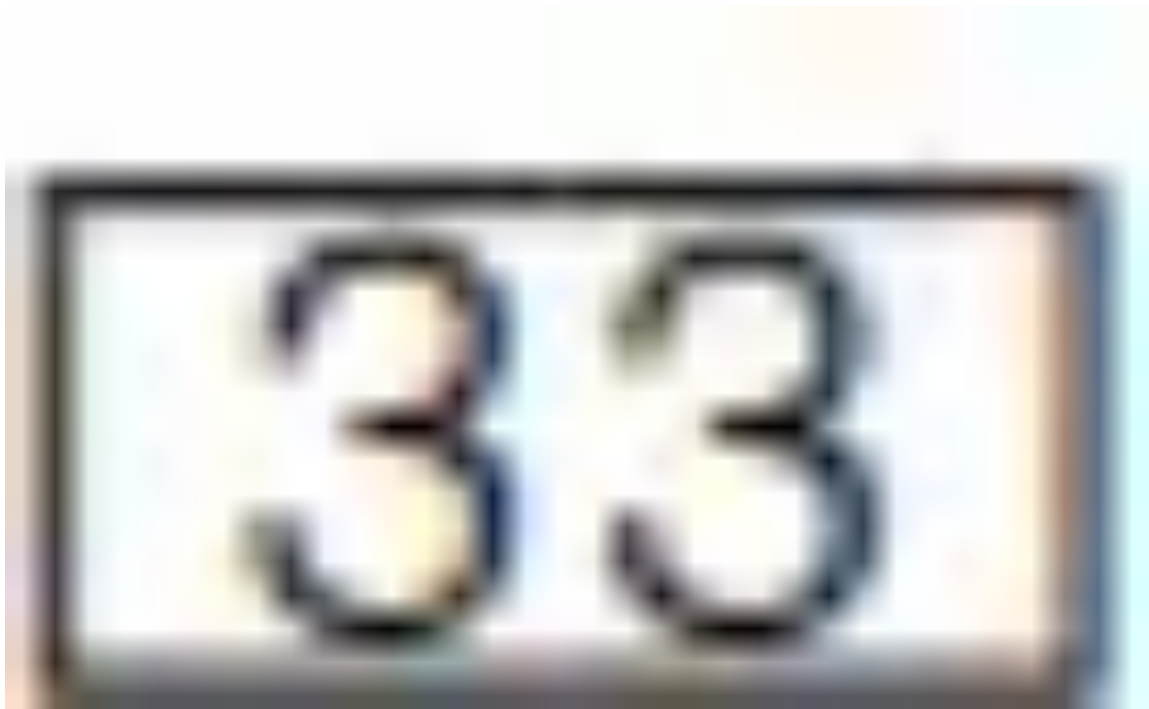

still closed, push the button

is

3 4

to

open it.

**Note:** Make sure the detergent dispenser is dry and clear of detergent residue.

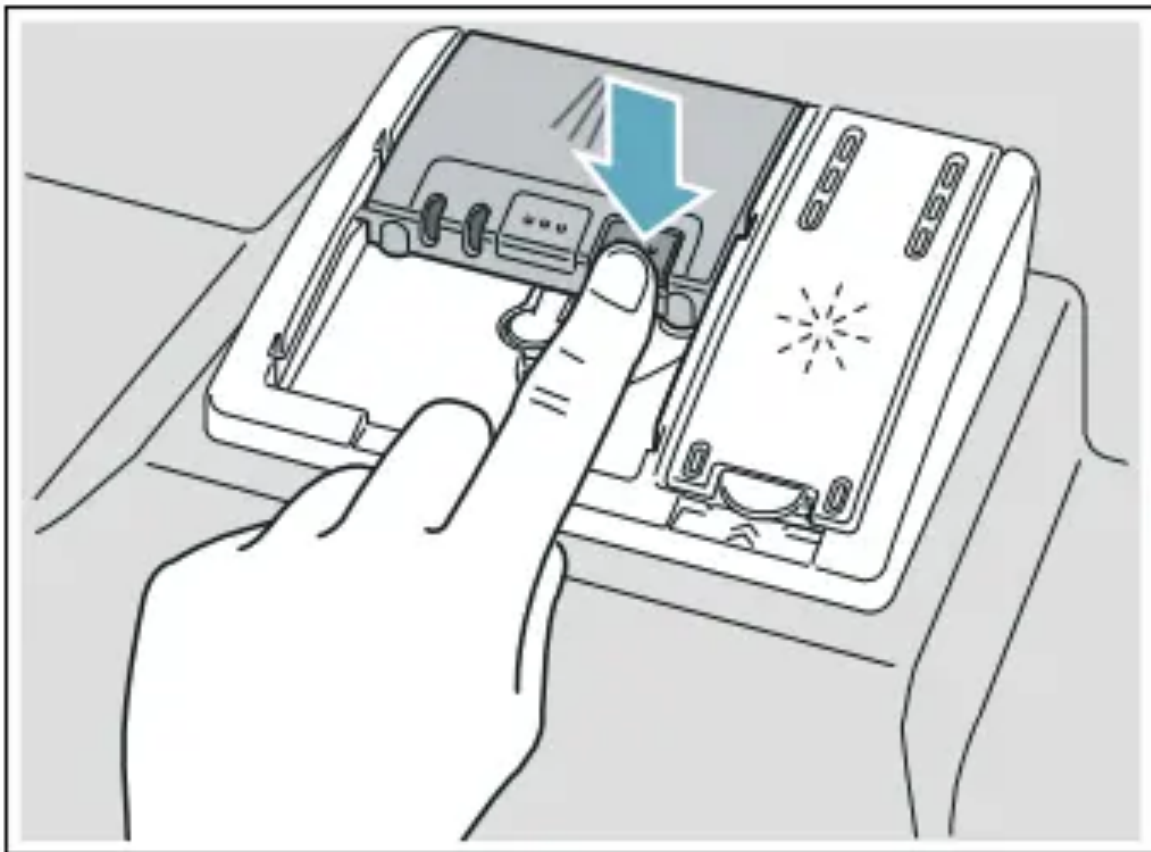

2. When using detergent tabs, lay them such that they do not come in contact with the cover, insert a detergent tab flat, not on its side.

**Note:** Do not place detergent tabs or utensils in the detergent tab tray

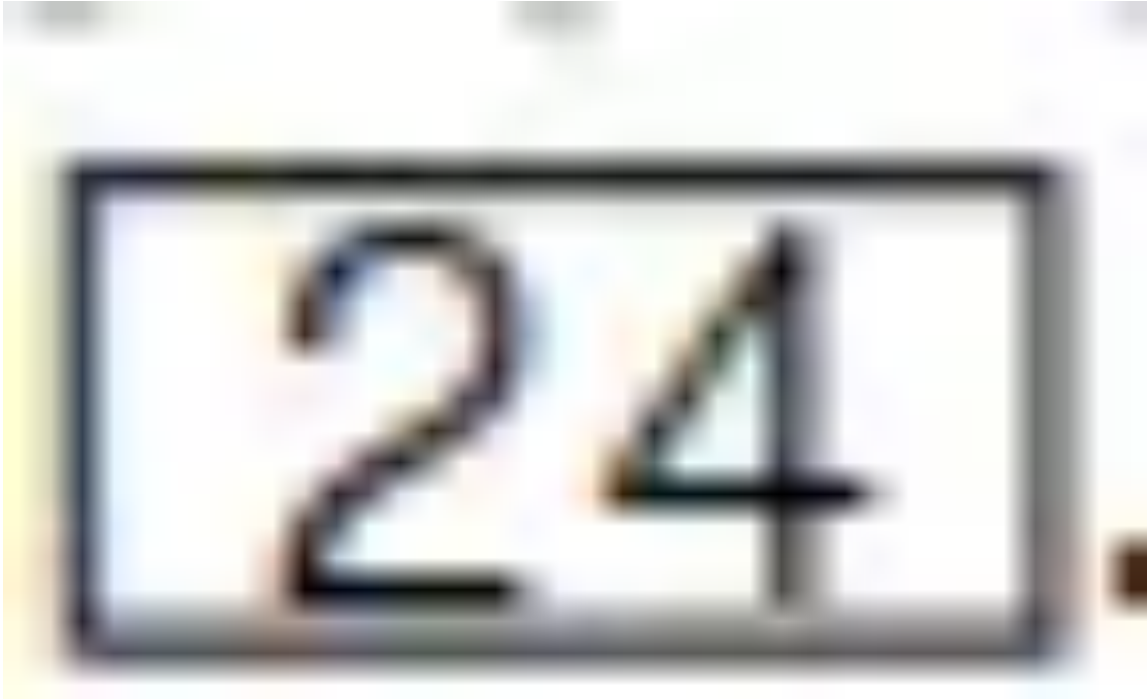

Place tabs or other detergent forms directly in the detergent dispenser

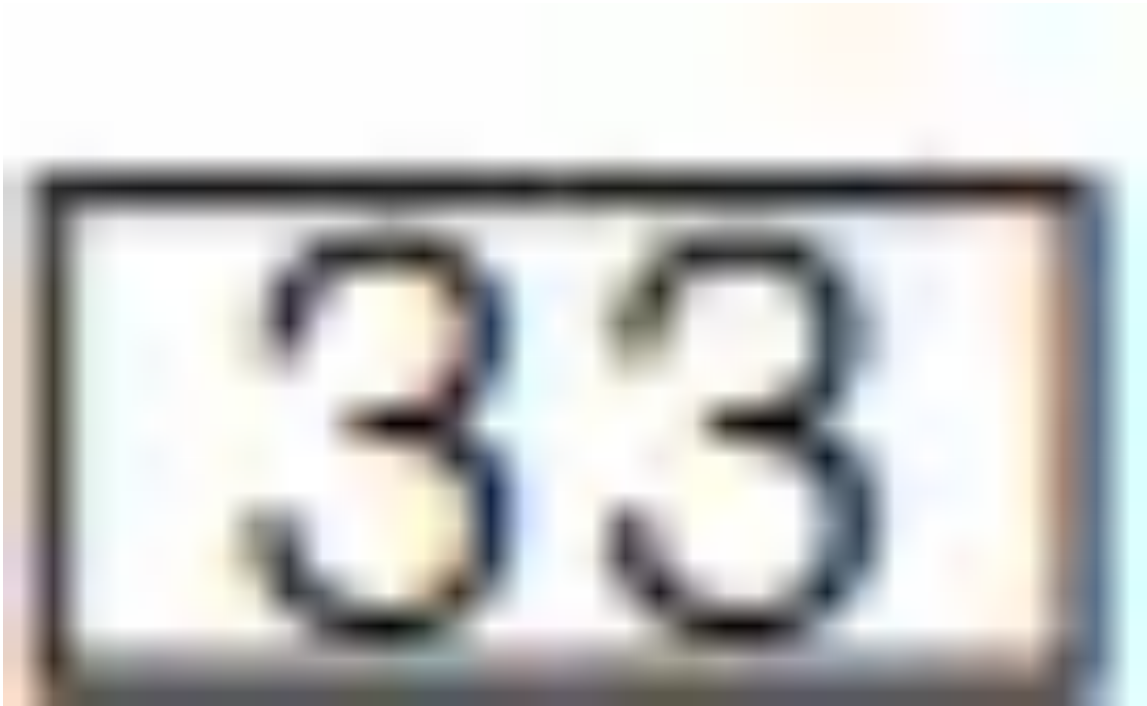

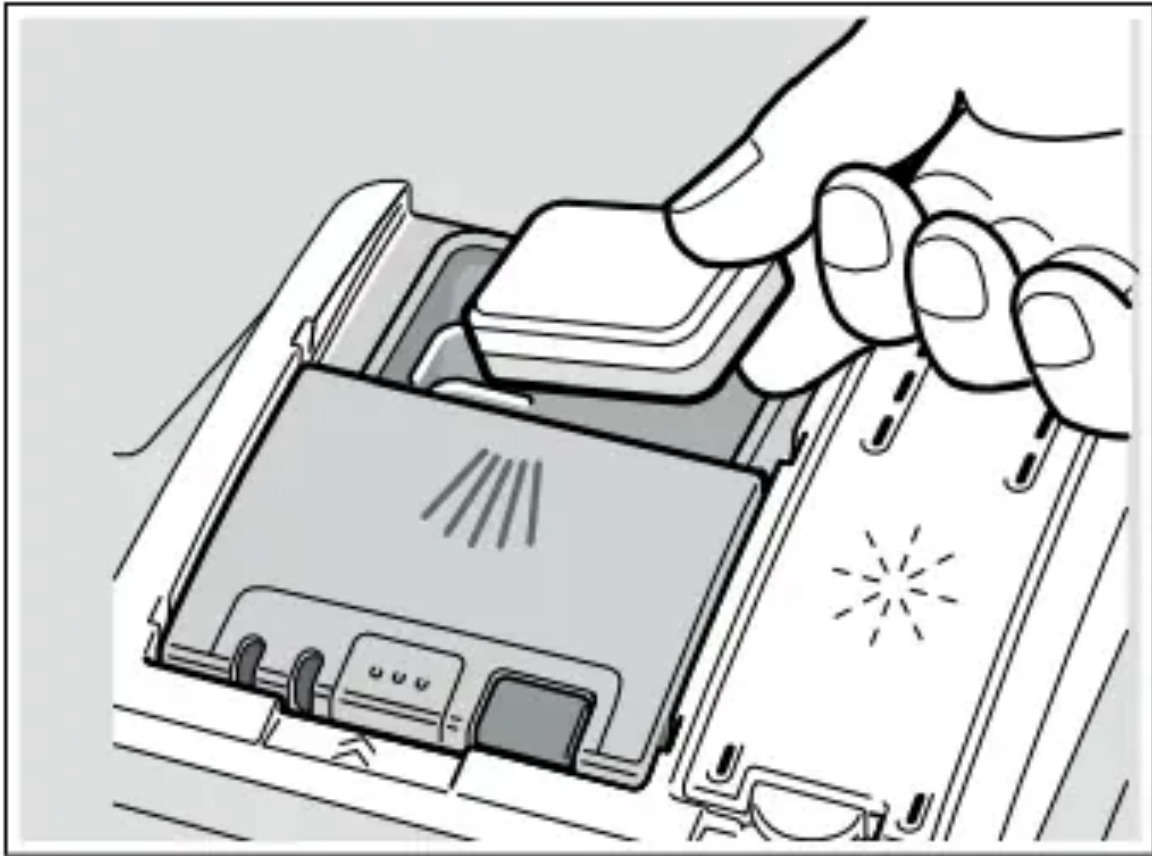

Pour detergent into the dry detergent dispenser



only. Add detergent. Do not overfill the detergent dispenser.

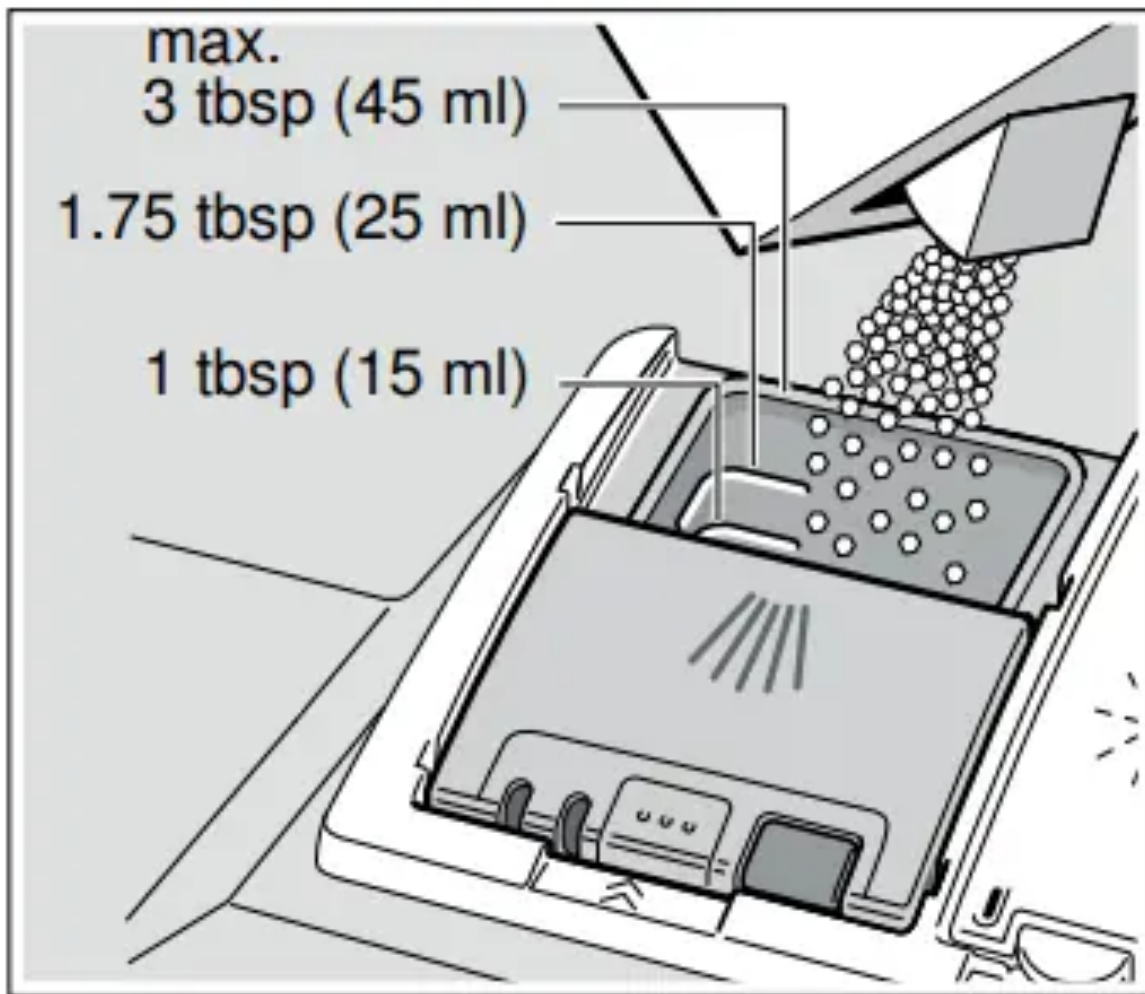

Dosage: see manufacturer's instructions on the packaging.

3. Close the lid by placing the finger on the lid as shown. Slide the lid closed until it clicks.

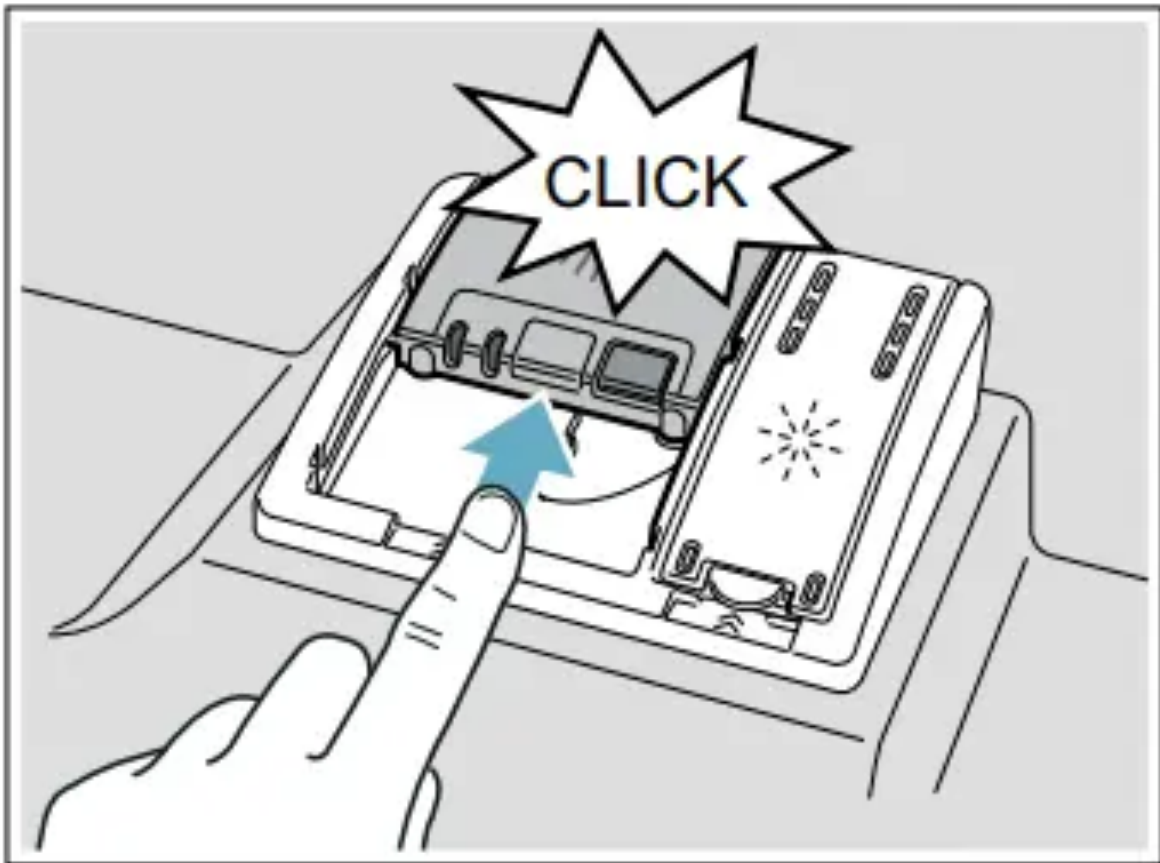

The detergent dispenser will open automatically at the ideal time for the set cycle. The powder or liquid detergent is distributed in the appliance and is dissolved, detergent tabs will fall into the detergent tab tray

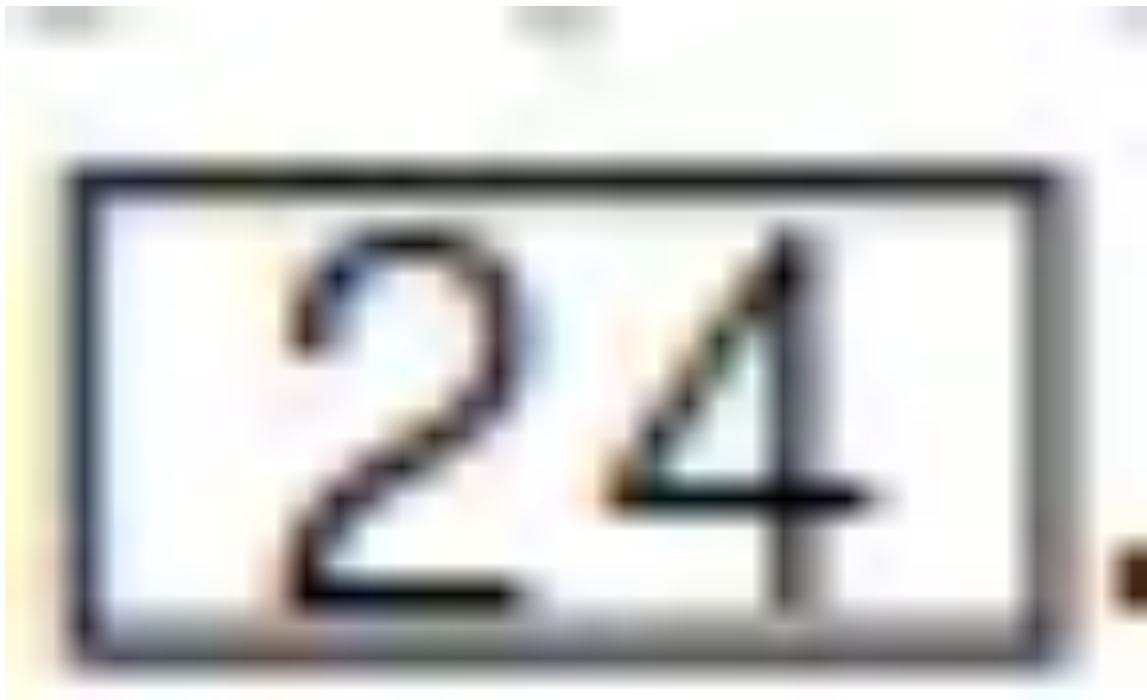

where it dissolves during the cycle.

**Tip:** If the dishware is only lightly soiled, slightly less than the indicated amount of detergent is usually adequate.

## Dishwasher Cycles

Wash cycle	Recommended use	Possible wash cycle option
<b>Heavy</b>	Best for cleaning items with baked-on food or grease. These dishes would normally require soaking or hand scouring.	all
<b>Auto</b>	Smartest cycle, with most flexible soil sensing, which is ideal for mixed dishware and food soils.	all
<b>Eco*</b>	The Eco cycle uses less energy with lower temperatures and a shorter cycle length . Perfect for lightly soiled dishes.	all
<b>Glass*</b>	Best for delicate dishes and glasses, the Glass cycle lowers temperature and cycle length to decrease energy usage.	<b>Delay</b> <b>Half Load</b> <b>CrystalDry™</b>
<b>Normal</b> (see note at bottom of table)	Recommended for daily, regular or typical use to completely wash a full load of normally soiled dishes.	all <b>Note:</b> In order to obtain optimal performance with minimum energy consumption, it is recommended to disable all available options and settings, except <b>Auto Power Off</b> - set to <b>P:0 1</b>
<b>Speed60®</b>	Cleans freshly soiled dishes with easy to remove soils. This cycle reduces cycle time while still including drying.	<b>Delay</b>
<b>Express</b>	Cleans lightly soiled dishes and reduces overall wash time. Use this cycle to clean glasses and dessert dishware that may need to be reused at the same event.	<b>Delay</b>
<b>Rinse</b>	Use this cycle if you need to rinse dishes to avoid odors. Place unrinsed dishes inside the dishwasher and select the <b>Rinse</b> cycle. Uses less water than hand rinsing and very low energy.	<b>Delay</b>

\*the number of wash cycles and options depends on the features of your dishwasher

**Note:** The Energy Guide label was based on the **Normal** soil sensing cycle as follows: The unit was tested without any rinse aid (liquid) in the rinse aid dispenser





.A

single dose of detergent was inserted into the detergent dispenser



with no detergent being used in the prewash. The unit was not subjected to truncated testing per the definitions in the test procedure. We recommend that dish loads such as the one in the energy certification test have the rack position set in the highest position.

## **P+** Dishwasher Cycle Options

### **Delay**

- Allows you to delay the start time of your dishwasher up to 24 hours.

### **Half Load**

- Can reduce water consumption when washing small, lightly soiled loads that fill approximately half or less of the dishwasher's capacity

## **Delicate**

- This option's reduced time and temperature are best for lightly soiled items with easy to remove food soils. The option also reduces the likelihood of cloudy glasses. Rinse aid is recommended for the high gloss drying function (even when using combination detergents).

## **Sanitize**

- Increases the temperatures and retains them for an extra long time to obtain a defined disinfecting performance. Continuous use of this function increases the hygiene status. This additional option is ideal for cleaning items such as chopping boards and baby bottles.
- "Sanitized" will appear in the display window when sanitation requirements are met. Using the Sanitize option may also improve drying. There is a slight increase in energy consumption.

## **CrystalDry™**

- Patented CrystalDry™ technology thoroughly dries dishes and plastics such as baby bottles and food storage containers. Natural minerals transform moisture into heat up to 176F to get dishes, even plastics 60% drier.\*
- \* Based on aggregate average drying performance of Bosch Dishwashers with CrystalDry™ on combined household load including plastics, glass, steel, and porcelain as compared to Bosch Dishwashers with PureDry. Drying performance may vary by dish type.

## **Eco \***

- The "Eco" function can be used to reduce water and energy consumption. The running time is extended for optimum cleaning and drying results.

## **ExtraScrub® \***

- This option increases pressure and temperature in the lower rack for intensive cleaning.

## **Wash Cycle Information**

To save energy, this dishwasher has EcoSense where the sensors in the dishwasher automatically adjust the cycle length, temperature and water changes based on the amount of food soil and the incoming water temperature. The "Smart Control" makes decisions that can cause the cycle time and water usage to adjust intermittently. Wash cycle times are based on 120°F (49° C) water supply. If your household water supply is different than 120°F (49° C), your dishwasher's cycle times may be impacted.

	Heavy	Auto	Glass	Normal	Eco	Speed60 <sup>®</sup>	Express	Rinse
Cycle time min.	110-135	105-129	75-85	130-135	75-85	60	30	9
Water usage gal/L	4.9-6.4/ 18.6-24.2	3.4-6.4/ 12.9-24.1	2.4-3.9/ 9.0-14.6	2.3-5.5/ 8.8-21	2.4-3.9/ 18.6-24.6	3.8/ 14.3	2.8/ 10.5	1.1/ 4.1
Wash temp. °F/°C	151-160/ 66-71	127-140/ 53-60	113-122/ 45-50	113-131 / 45-58	113-122/ 45-50	122/ 50	113/ 45	incom- ing
Rinse temp. °F/°C	151/ 66	136/ 58	122/ 50	136/ 58	122/ 50	158/ 70	124/ 51	incom- ing
<b>Half Load</b>								
Cycle time min.	114	95-105	70-80	100-105	70-80	N/A	N/A	N/A
Water usage gal/L	4.7/ 17.9	2.7-4.4/ 10.2-16.5	2.4-3.3/ 9.2-14.5	2.9-3.7/ 10.8-13. 9	2.4-3.3/ 9.2-14.5	N/A	N/A	N/A
Rinse temp. °F/°C	151/ 66	136/ 58	122/ 50	136/ 58	145/ 63	N/A	N/A	N/A
<b>Delicate</b>								
Cycle time min.	105-120	100-110	N/A	100-120	N/A	N/A	N/A	N/A
Water usage gal/L	4.9-6.4/ 18.6-24.2	3.4-6.4/ 12.9-24.1	N/A	2.3-5.5/ 8.8-21.0	N/A	N/A	N/A	N/A
Rinse temp. °F/°C	140/ 60	122/ 50	N/A	122/ 50	N/A	N/A	N/A	N/A
<b>Sanitize</b>								
Cycle time min.	125-150	125-150	N/A	150-155	N/A	N/A	N/A	N/A
Water usage gal/L	4.9-6.4/ 18.6-24.2	3.4-6.4/ 12.9-24.1	N/A	2.3-5.5/ 8.8-21	N/A	N/A	N/A	N/A
Rinse temp. °F/°C	162/ 72	162/ 72	N/A	162/ 72	N/A	N/A	N/A	N/A
<b>Extra Scrub</b>								
Cycle time min.	125-150	120-145	90-100	145-150	90-100	N/A	N/A	N/A
Water usage gal/L	4.9-6.4/ 18.6-24.2	3.5-6.4/ 13.13-24. 1	2.4-3.9/ 9.3-14.5	2.3-5.5/ 8.8-21.0	2.4-3.9/ 9.3-14.5	N/A	N/A	N/A
Rinse temp. °F/°C	151/ 66	136/ 58	122/ 50	136/ 58	122/ 50	N/A	N/A	N/A
<b>CrystalDry™</b>								
Cycle	140-165	135-159	105-115	160-165	105-115	N/A	N/A	N/A

**Note:** Only sanitizing cycles have been designed to meet the requirements of Section 6 of the NSF/ANSI Standard for Residential Equipment for soil removal and sanitization efficacy. There is no intention, either directly or indirectly, to imply that all cycles have passed sanitization performance tests.



## Operating the Dishwasher

**Note:** With hidden controls, the door must be opened before changing settings and closed after changing settings.

### **WARNING**

**RISK OF INJURY!** To avoid risk of injury, always use caution when opening the door during or following a wash cycle as hot water or steam may escape. Do not fully open the door until water noises have stopped and steam has subsided.

## Protection against unintentional operation

Your dishwasher is equipped with a function that helps to prevent unintentional operation (e.g. by children).

After starting the dishwasher, the dishwasher door has to be closed within 4 seconds, otherwise the operation will be paused. There will be a signal on the control panel advising you to press the Start button again and close the door.

This function will be activated when:

- Pressing Start to begin a wash cycle
- Setting Delay time and pressing Start
- Opening the door while Delay time is active
- Opening the door during a wash cycle.

Note: This function cannot be deactivated.

## AquaSensor

- The AquaSensor is an optical measuring device which measures the cleanliness of the rinse water.
- The AquaSensor is used according to the wash cycle. If the AquaSensor is active, “clean” rinse water can be transferred to the next rinse and water consumption can be reduced by 0.8–1.5 gal (3–6 liters). If the rinse water is not yet clear, the water is drained and is replaced with fresh water. In the automatic wash cycles the temperature and running time can also be adjusted to the degree of soiling.

## Switching the appliance on

1. Turn the water supply on fully.
2. Open the door.

3. Press the On/Off button

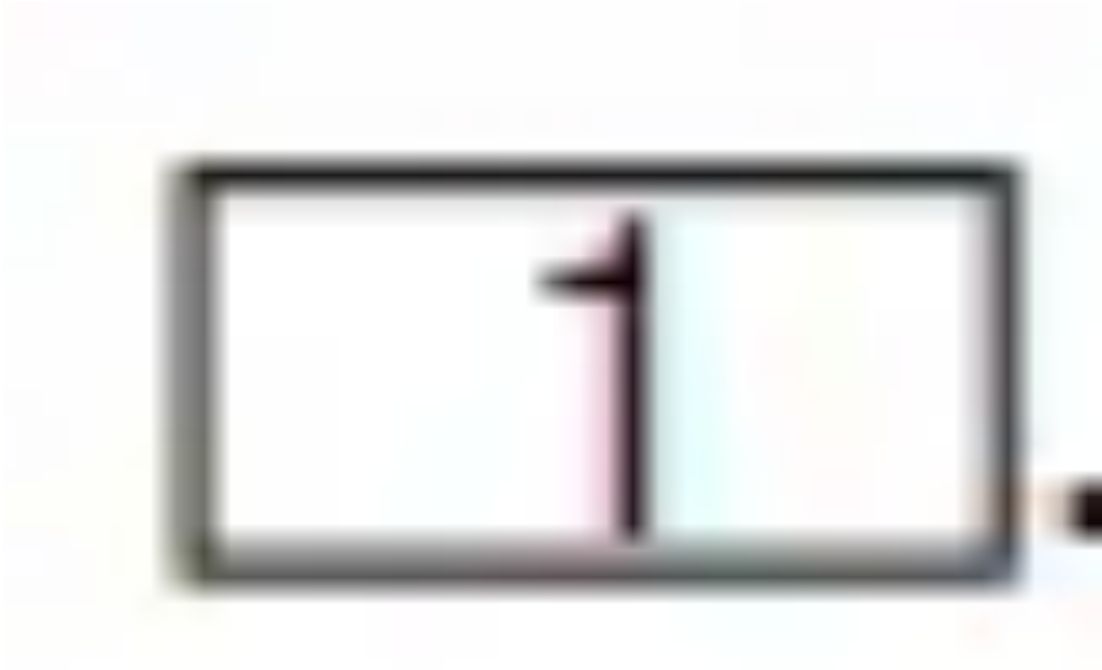

The display of the last selected wash cycle flashes. This wash cycle remains selected if no other wash cycle button

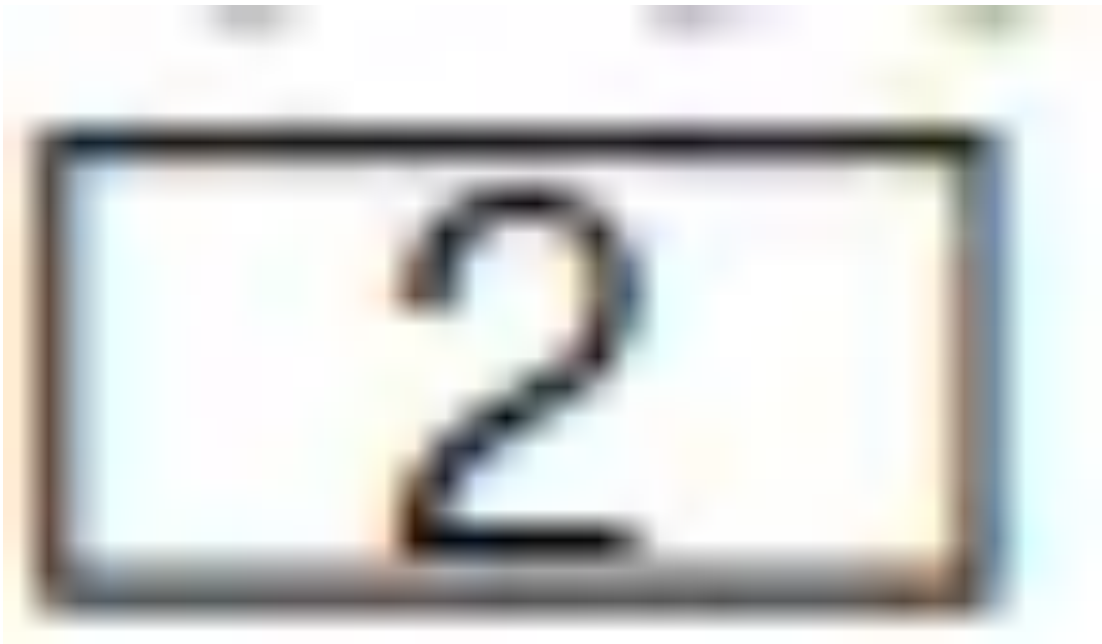

pressed. The expected wash cycle duration flashes on the display

is

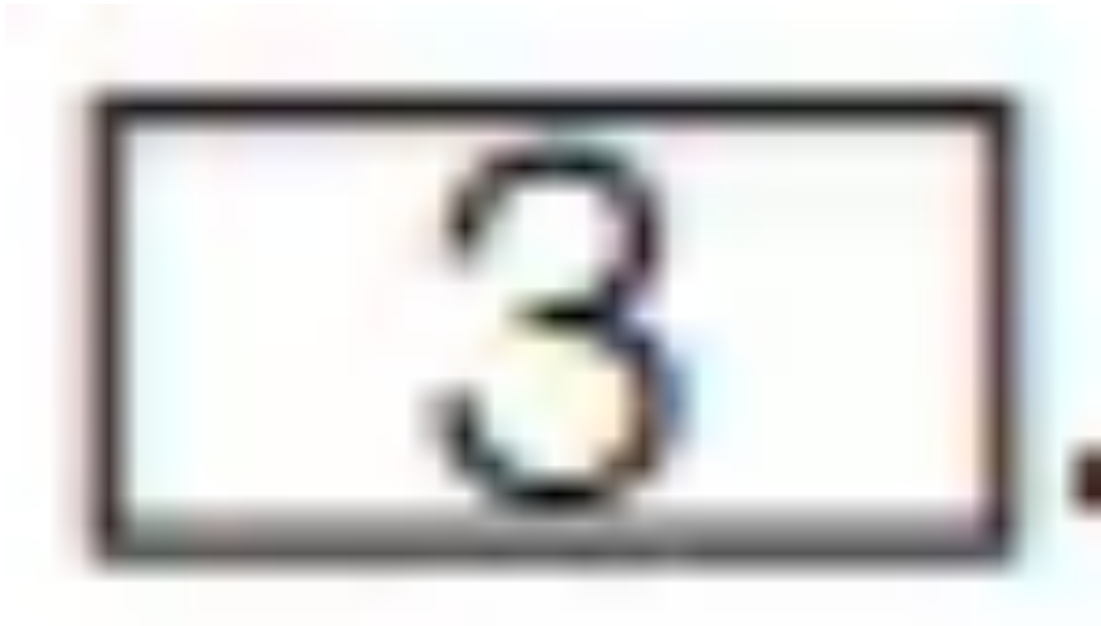

Select any desired option.

4. Press Start button

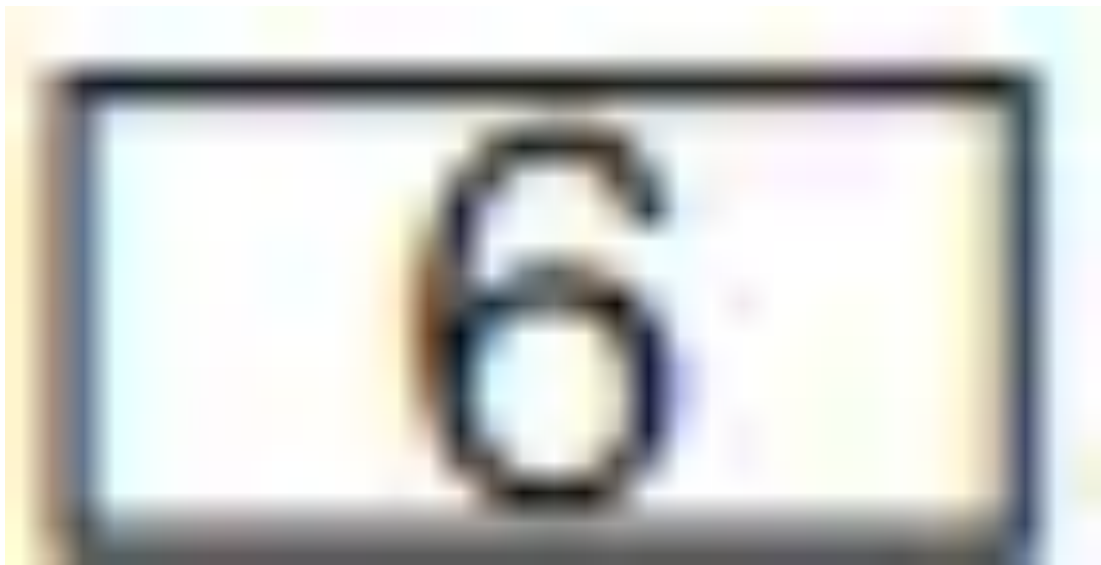

Wash cycle sequence starts.

**Note:** Your dishwasher is protected against unintentional operation. If the appliance door remains open for more than 4 seconds after pressing the Start button, the operation will be paused. Press the Start button again and close the appliance door.

## Time display

- When a wash cycle is selected the remaining wash cycle time is shown on the display

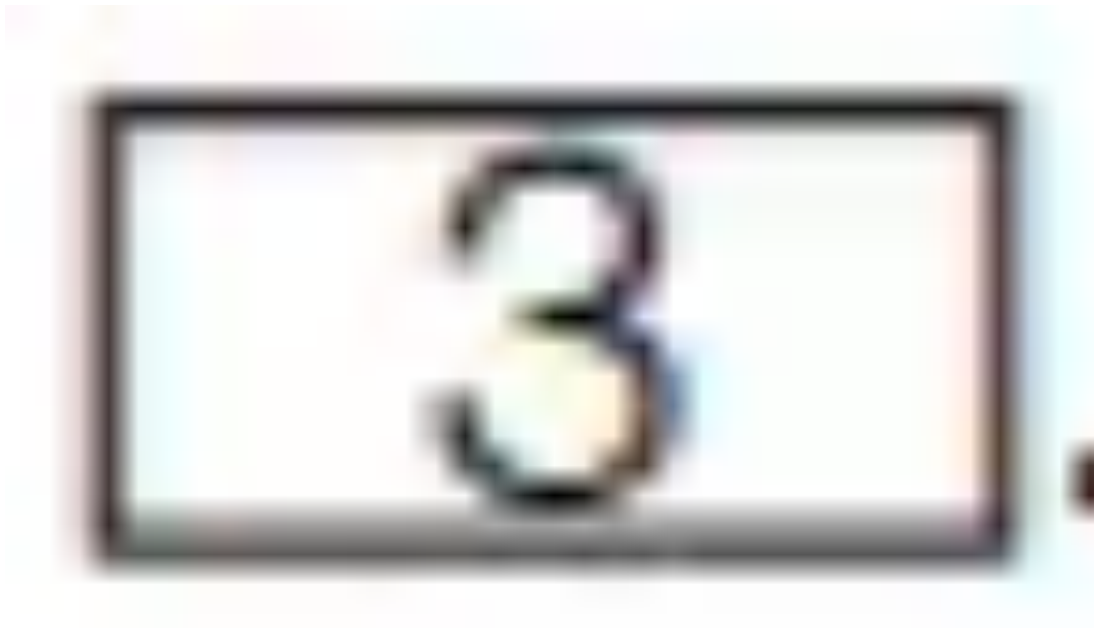

- The wash cycle time is determined during the wash cycle by the water temperature, the amount of dishes, as well as the degree of soiling and may vary (depending on the selected wash cycle).

## Delay Start

You can delay the start of the cycle in one hour increments up to 24 hours.

1 hour delay

24 hours delay

To set Delay start:

1. Open the door and press the On/Off button

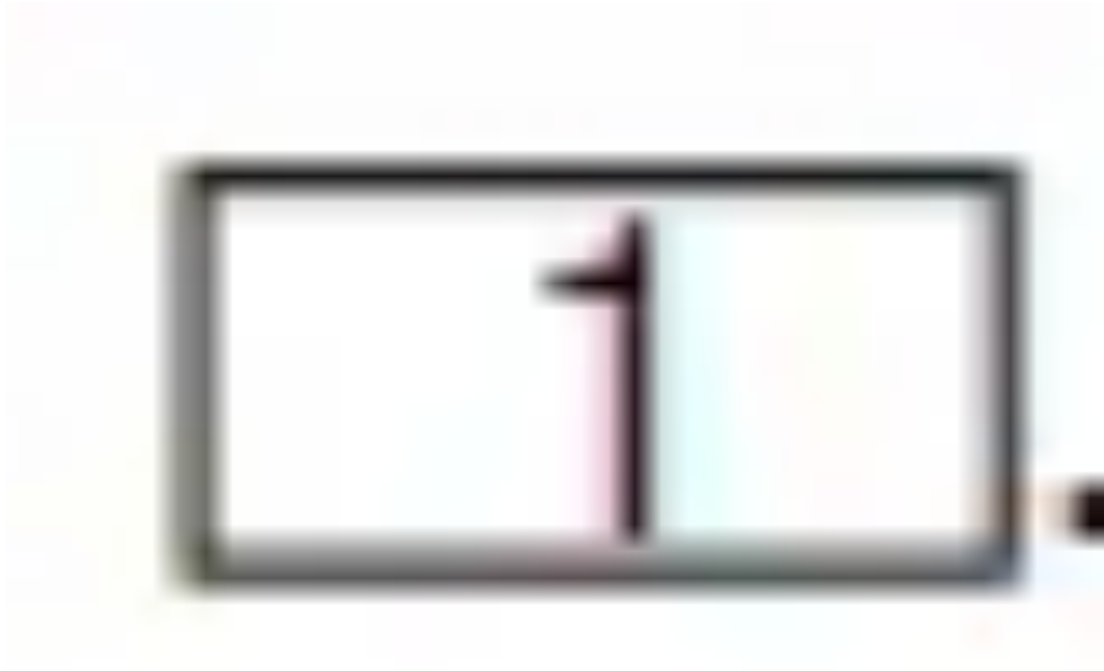

Select a cycle.

2. Press the Delay button from the wash cycle options 5 until the displayed time corresponds with your requirements.
3. Press the Start button

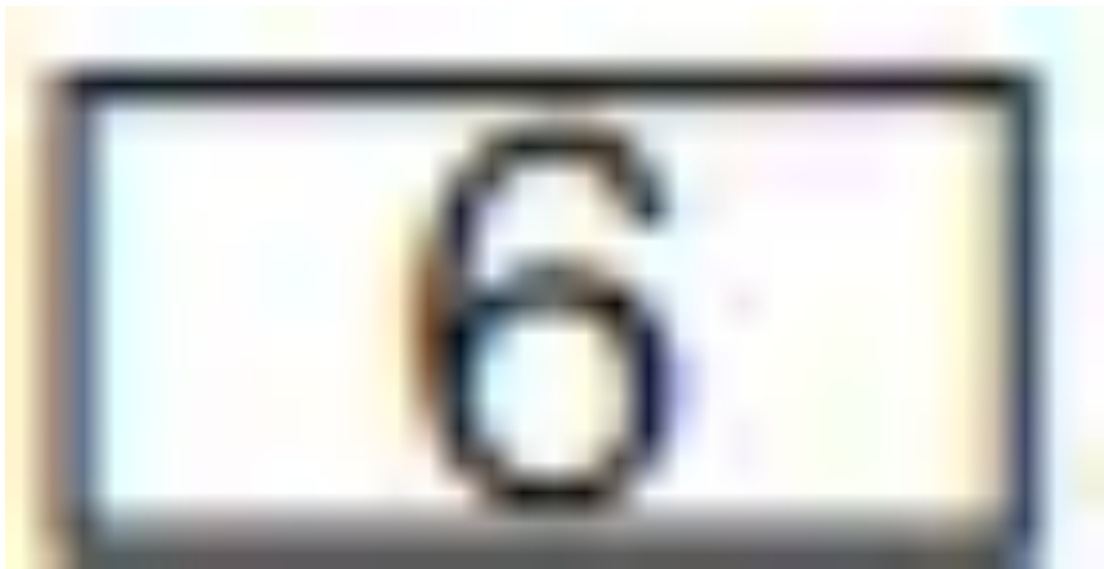

activate Delay start.

to

To cancel Delay start:

1. Open the door and press the Delay button until h:00 is indicated on the digital display

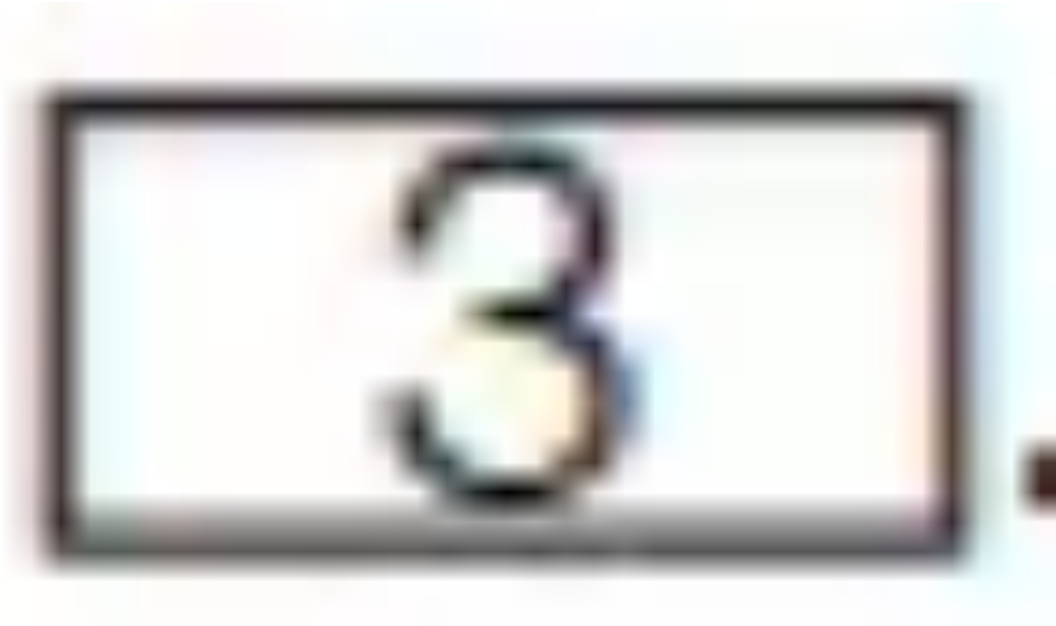

2. Press the Start button

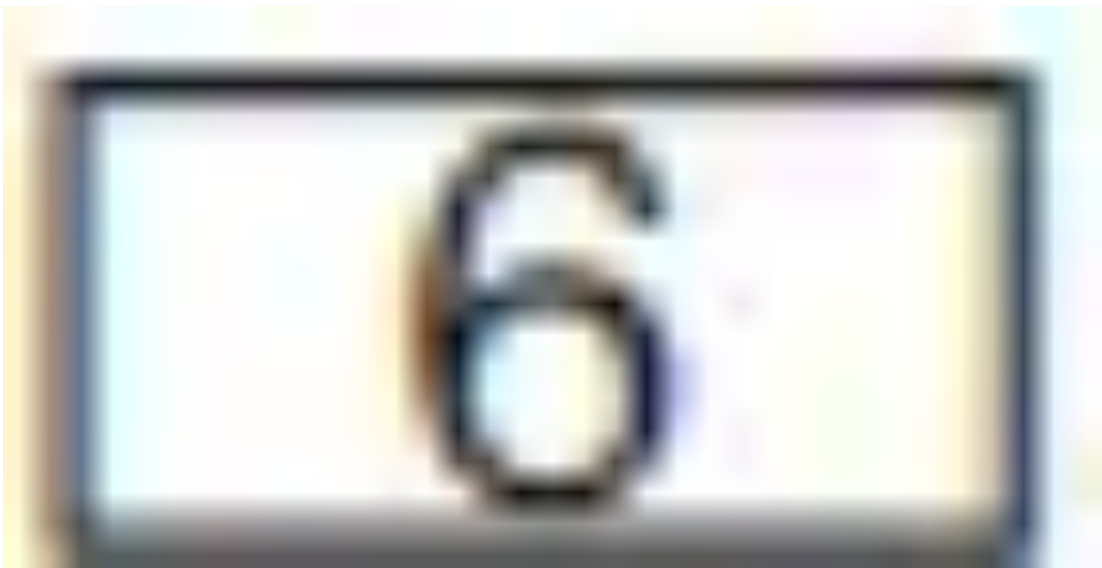

to save setting.

**Note:** Your dishwasher is protected against unintentional operation. If the appliance door remains open for more than 4 seconds after pressing the Start button, the operation will be paused. Press the Start button again and close the appliance door.

## Wash cycle end

The wash cycle has ended when the display

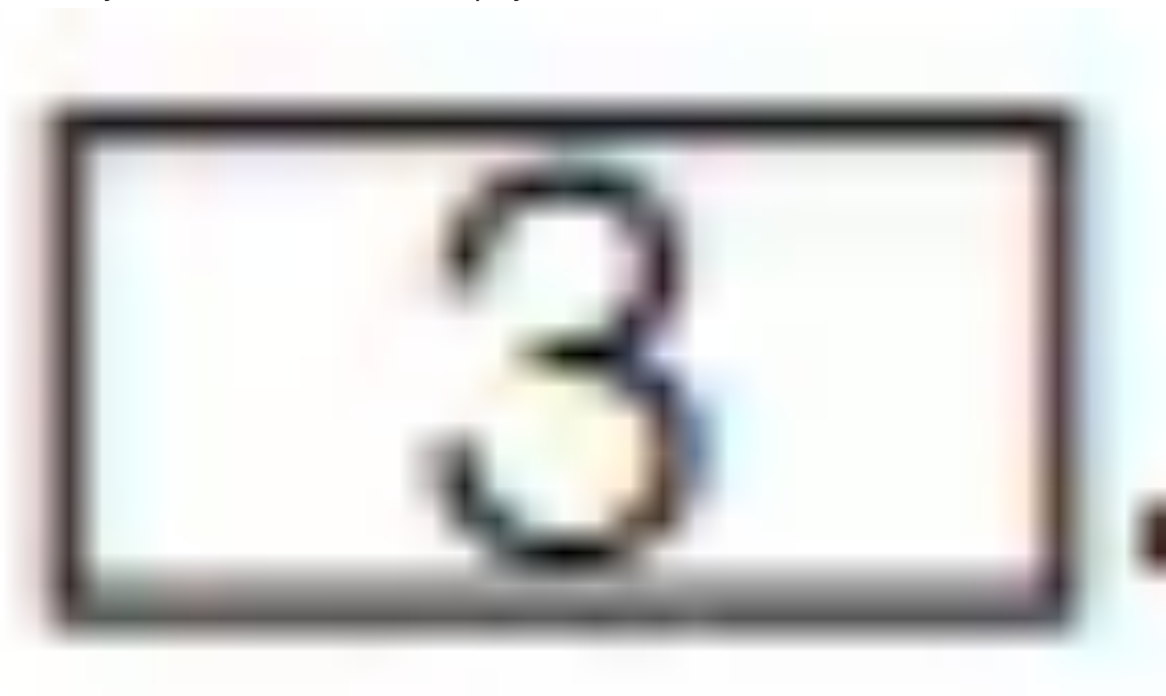

reads 0:00.

If the signal tone has been set, the wash cycle end is also indicated by a buzzer.

b:00	Off
b:01	low
b:02	medium
b:03	loud

**To change the signal volume:**

1. Open the door.

2. Press the On/Off button

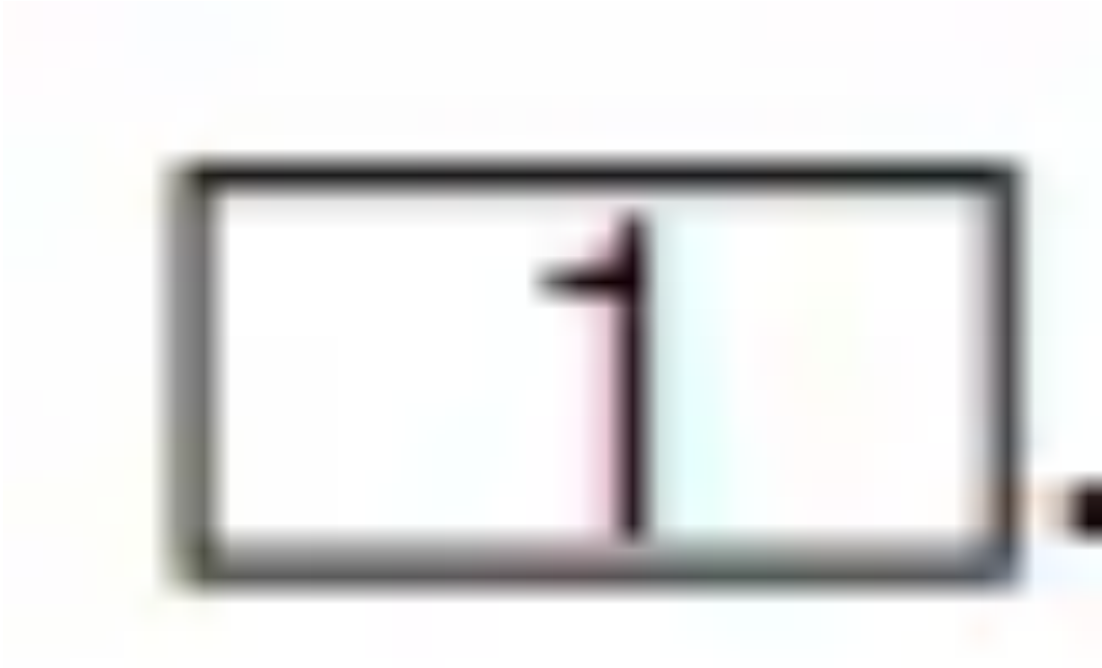

3. Hold down function key



press Start button

and

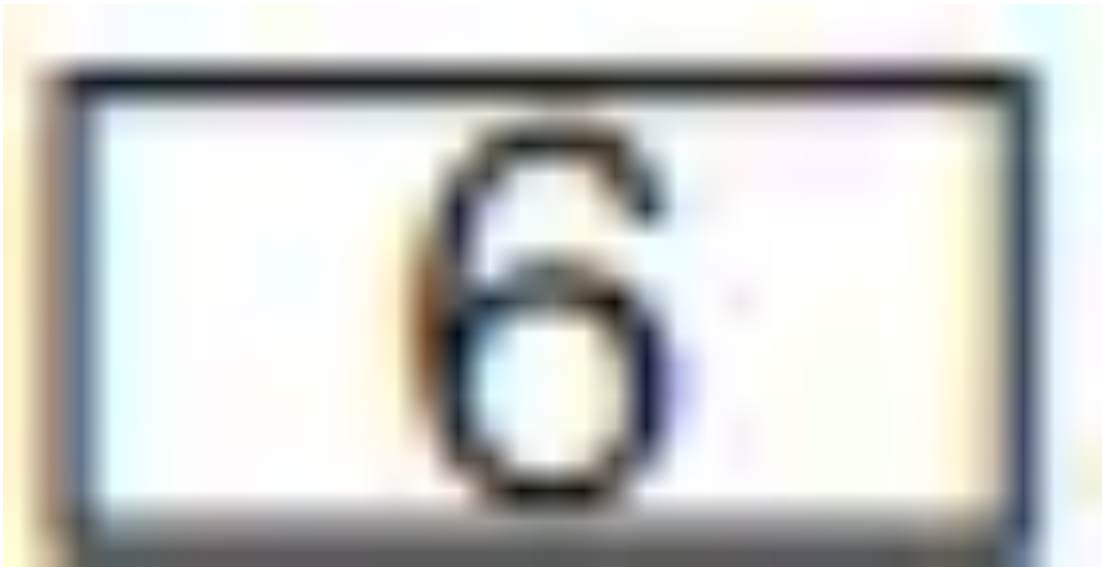

until the display

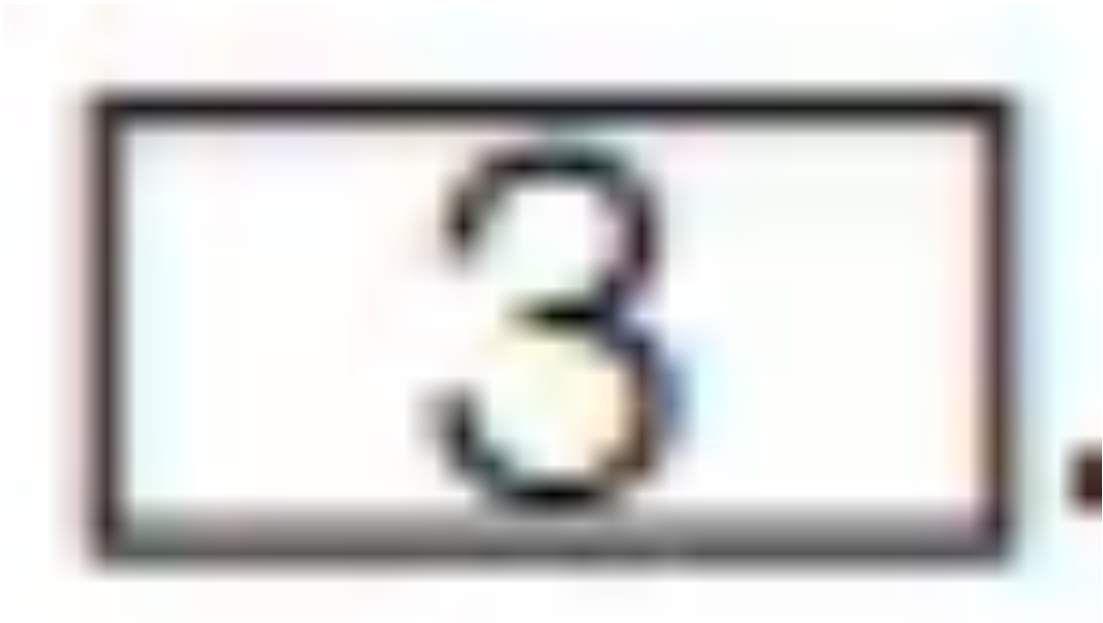

indicates **d:0x** (x can be any number). Release both buttons.

4. Press function key

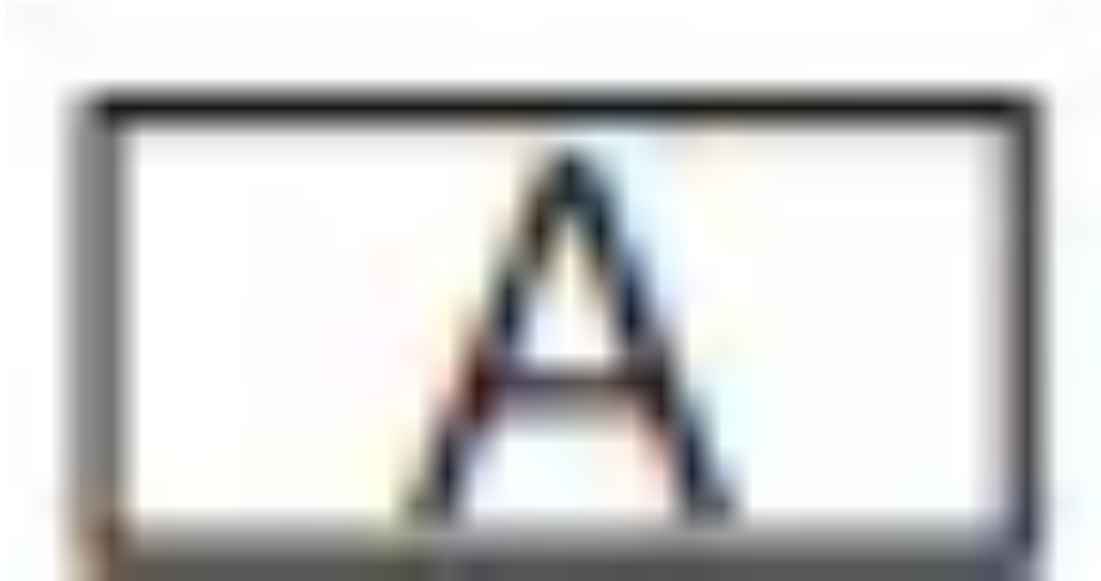

until

the display shows **b:02**.

5. Press function key

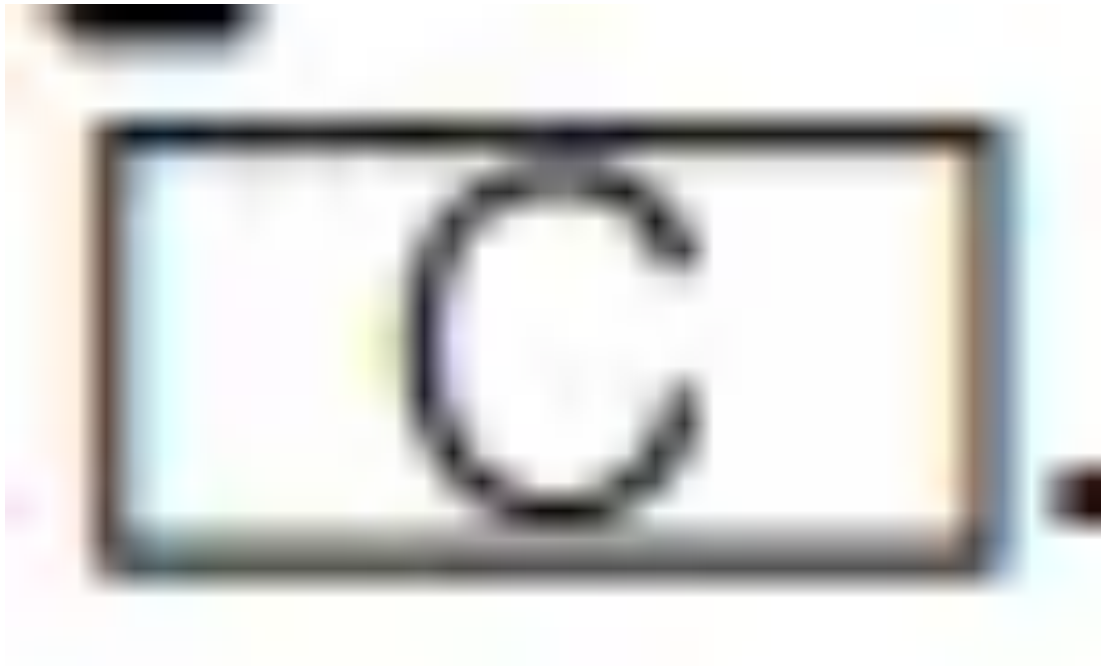

Each time the button is pressed the set value increases by one level; when it reaches the value **b:03**, the display jumps back to **b:00**(off).

6. Press Start button

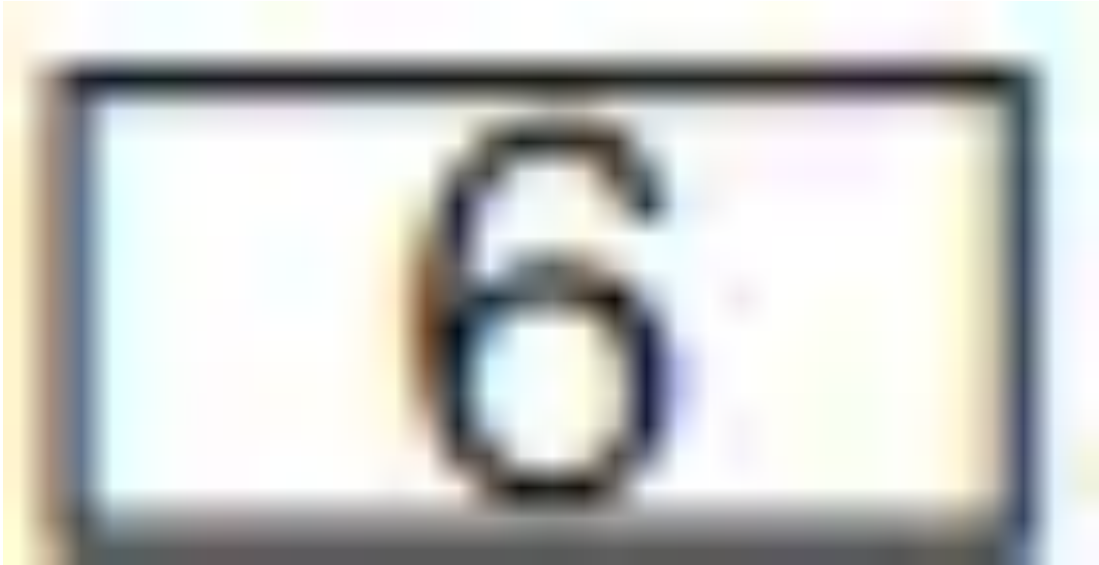

save the setting.

### Auto power off

This setting determines the length of time the control panel stays illuminated after the cycle is complete. To save energy the recommended setting is  $P:01$ .

This setting can be adjusted from  $P:00$  to  $P:02$ .

$P:00$	dishwasher does not turn off automatically
$P:01$	dishwasher turns off automatically after 1 minute
$P:02$	dishwasher turns off automatically after 120 minutes (2 hours)

### To change the setting:

1. Press the **On/Off** button  $\boxed{1}$
2. Hold down the function key  $\boxed{A}$  and press the **Start** button  $\boxed{6}$  until the display  $\boxed{3}$  indicates  $d:0x$  (x can be any number).
3. Release both buttons.
4. Press the function key  $\boxed{A}$  until the display  $\boxed{3}$  indicates  $P:0x$
5. Press the function key  $\boxed{C}$  until the display corresponds with your requirements.
6. Press the Start button  $\boxed{6}$

## Switching off the appliance

### Short time after the end of the wash cycle:

1. Press **On/Off** button .
2. Remove the dishes when they have cooled down.

### **WARNING**



#### RISK OF INJURY!

To avoid risk of injury, always use caution when opening the door during or following a wash cycle as hot water or steam may escape. Do not fully open the door until water noises have stopped and steam has subsided.

### Interrupting the wash cycle

#### **CAUTION**

Expansion (overpressure) may cause the appliance door to open and/or water to escape! If the door was opened on an appliance which has a hot water connection or is heated, always leave the door ajar for several minutes and then close.

1. Open the door.
2. Switch off On/Off switch . The LED's go out. The wash cycle is saved.
3. To continue the wash cycle, switch on the On/Off switch  again.
4. Close the door.

**Note:** Your dishwasher is protected against unintentional operation. If the appliance door remains open for more than 4 seconds after pressing the Start button, the operation will be paused. Press the Start button again and close the appliance door.

## Terminating the wash cycle (Reset)

1. Press and hold Start button

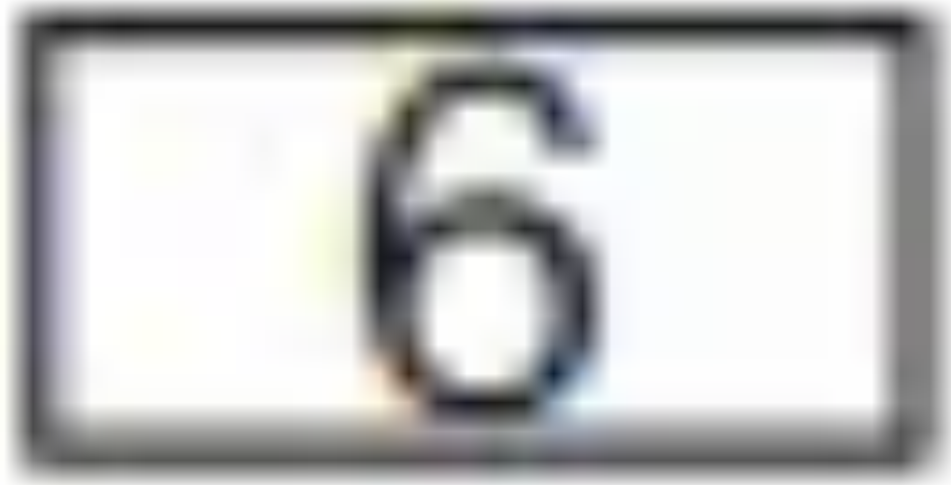

for approximately 3 seconds until the display reads



2. Wait about 1 minute while the dishwasher drains.

3. Press On/Off button

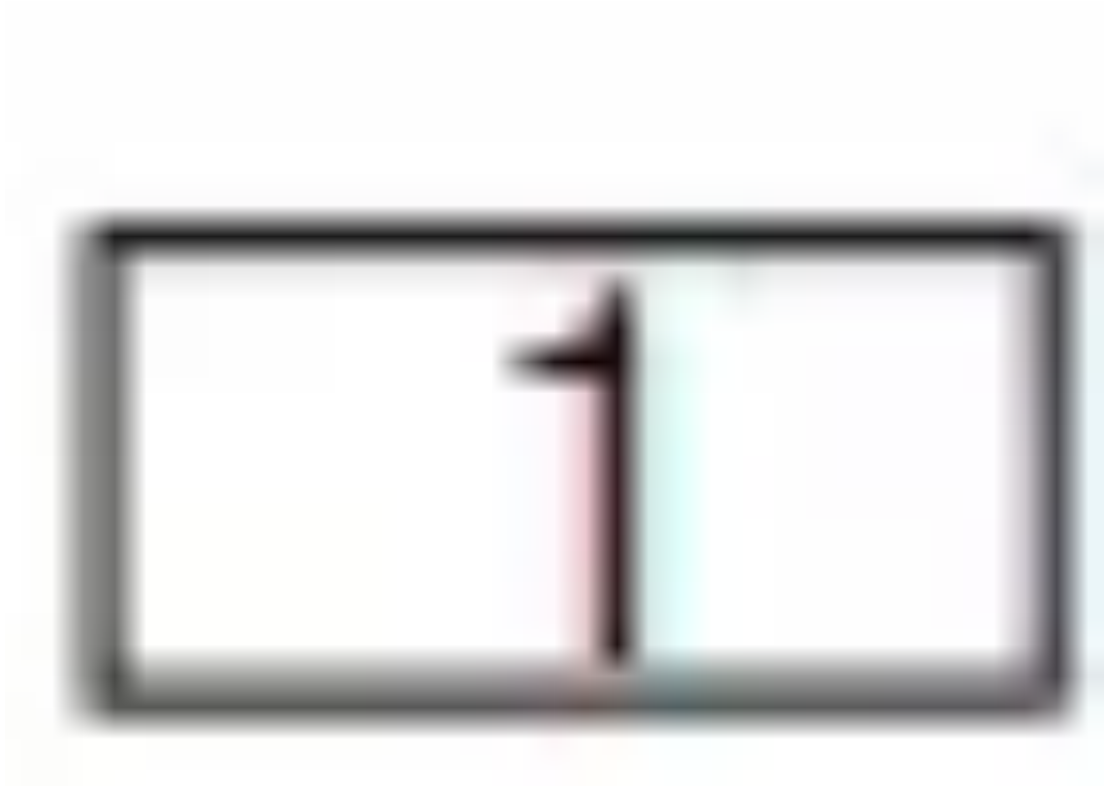

You may now power the dishwasher back on and begin a new cycle if desired.

## Changing the wash cycle

When the Start button



has been pressed, the wash cycle cannot be changed. The only way a wash cycle can be changed is by terminating the wash cycle (Reset).

### **InfoLight® \***

While the wash cycle is running, a light spot shines on the floor under the appliance door.

Do not open the appliance door until the light point is no longer visible on the floor.

If the appliance door is not completely closed, the light spot flashes\*.

If the appliance is installed at eye-level, with flush furniture front, the light point is not visible.

In darkened rooms, some light scattering may be visible. This is normal and cannot be changed.

You can switch the Infolight on or off.



Off



On

**To change the setting:**

1. Open the door.

2. Press the On/Off button

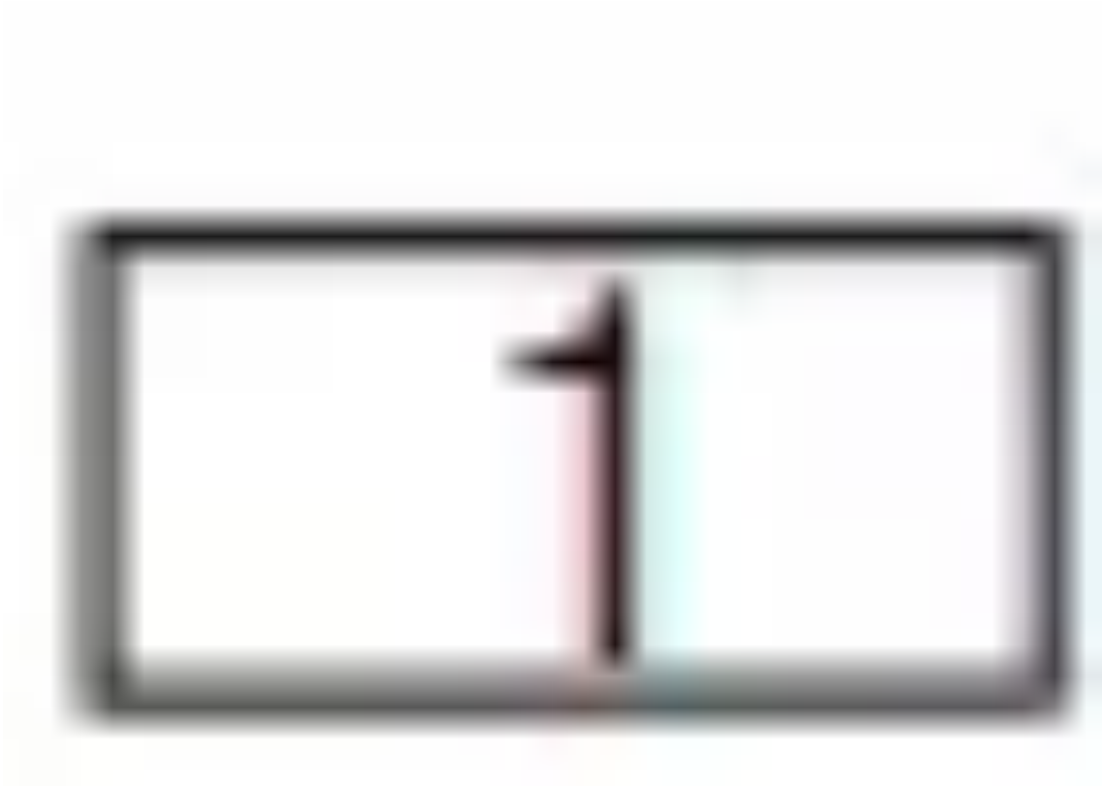

3. Hold down function key

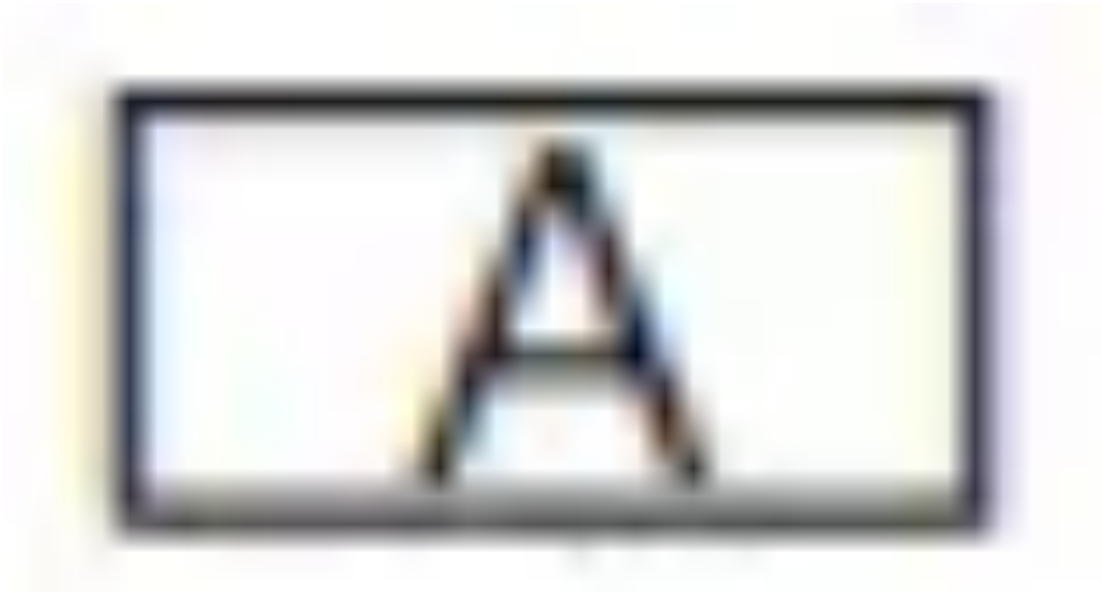

press Start button

and



until the display  indicates d:0x (x can be any number). Release both buttons.

4. Press function key



until the display shows 1:01.

5. Press the function key



to

switch the InfoLight® feature on 1:01, or off 1:00.

6. Press Start button

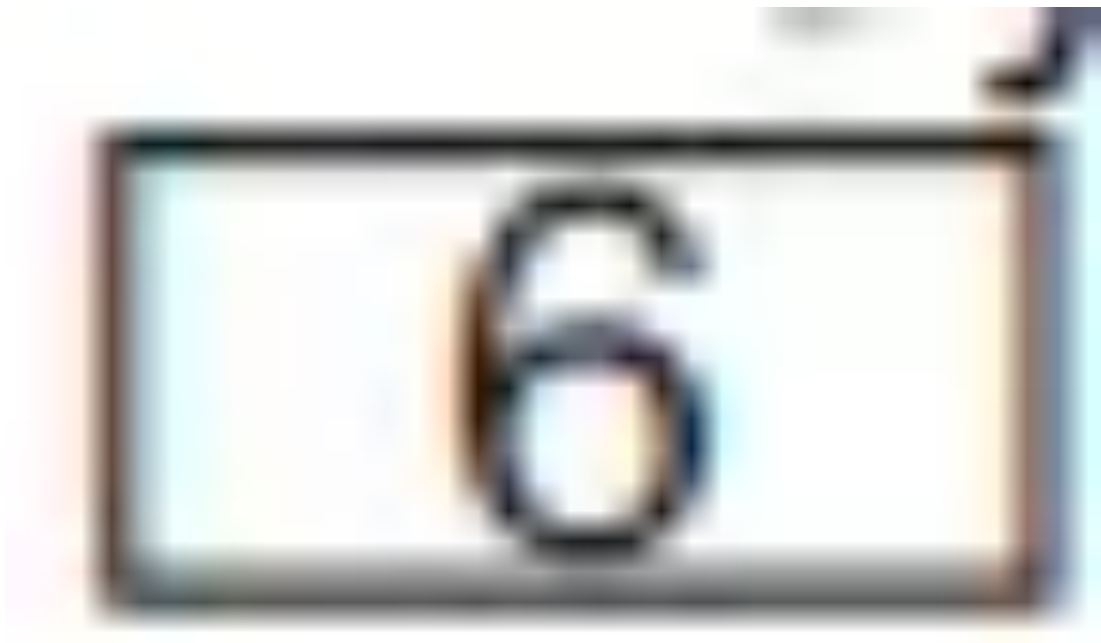

to

save the setting.

\* optional feature which may or may not be included with your dishwasher.

**TimeLight® (Optical display while the wash cycle is running) \***

While wash cycle is running, an optical display (time remaining alternating with cycle indicator images) is projected onto the floor under the appliance door.

You can switch the optical display on 5:01, or off 5:00.

**All time remaining displays**



**BOSCH**

**Bosch® logo**



**Pre-rinse**



**Cleaning**



**Rinsing**



**Drying**



**Cycle end**

**To change the setting:**

1. Open the door.
2. Press On/Off button



3. Hold down function key



press Start button

and



until the display  shows or (x can be any number).

4. Release both buttons. The light above function key



flashes and the display  shows the factory set value.

5. Press function key



until the display **3** shows the factory set value 5:01.

6. Press function key to switch between 5:00 and 5:01.

7. Press Start button



save setting.

to

\* optional feature which may or may not be included with your dishwasher.

### **Intensive drying**

The final rinse uses a higher temperature which improves the drying result. The cycle time may increase slightly. (Caution if utensils are delicate!)

This feature has two settings:

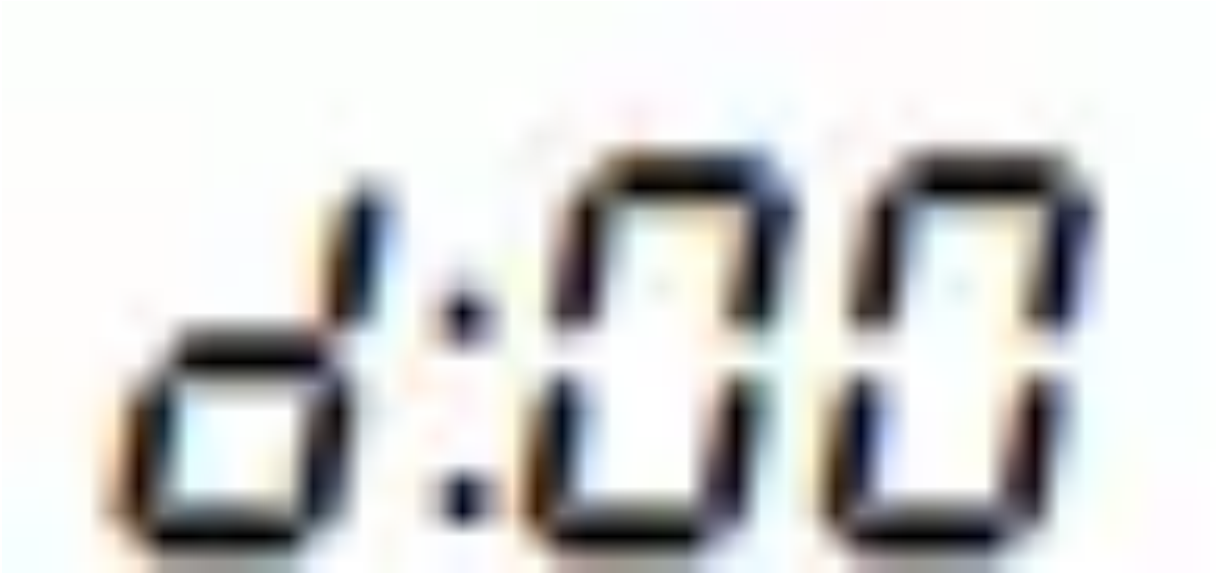

Off

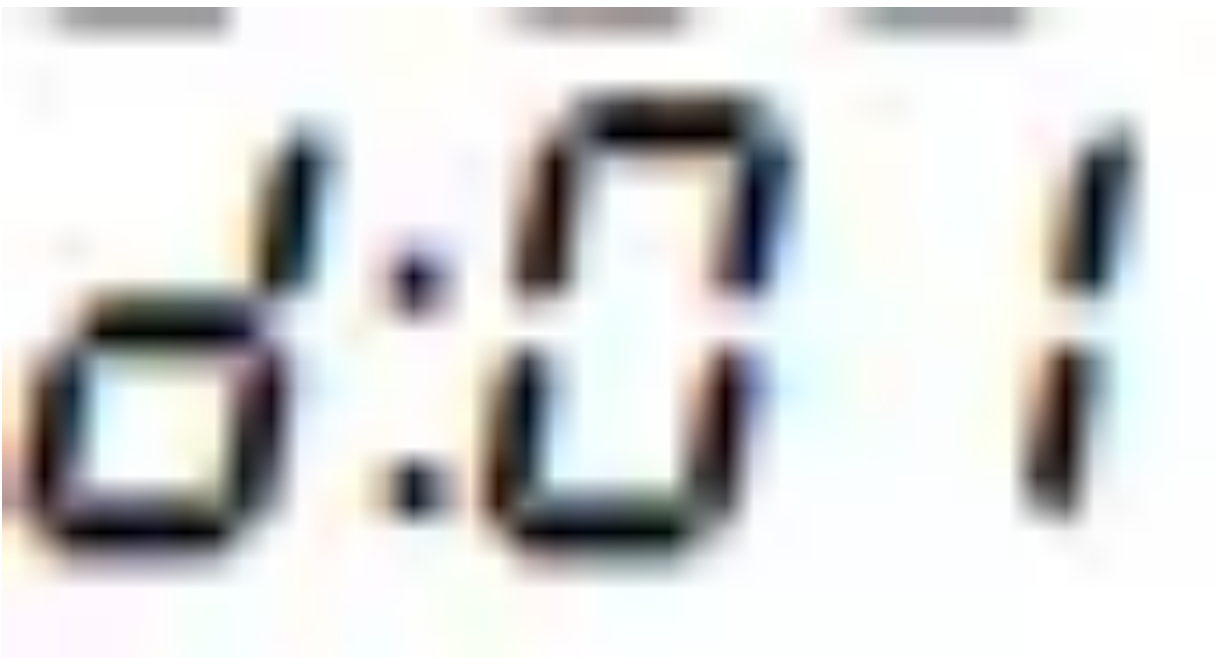

On

1. Open the door.

2. Press the On/Off button



3. Hold down function key



press Start button

and



until the display  indicates d:x (x can be any number).

4. Release both buttons.

5. Press function key



until the display  indicates the factory set value d:00.

6. Press function key



to

switch the Extra dry feature on

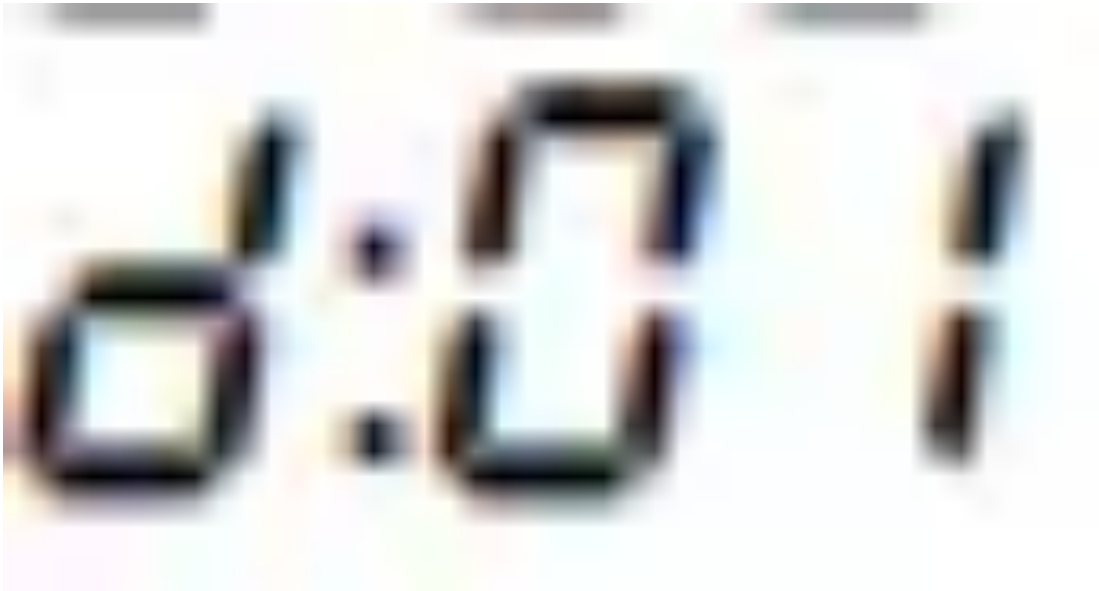

, or

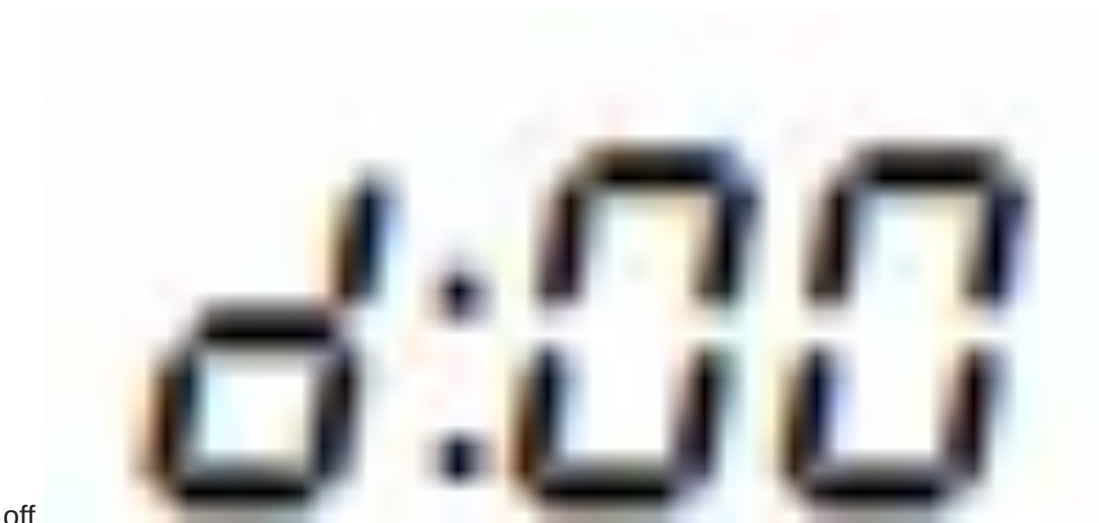

off

7. Press Start button

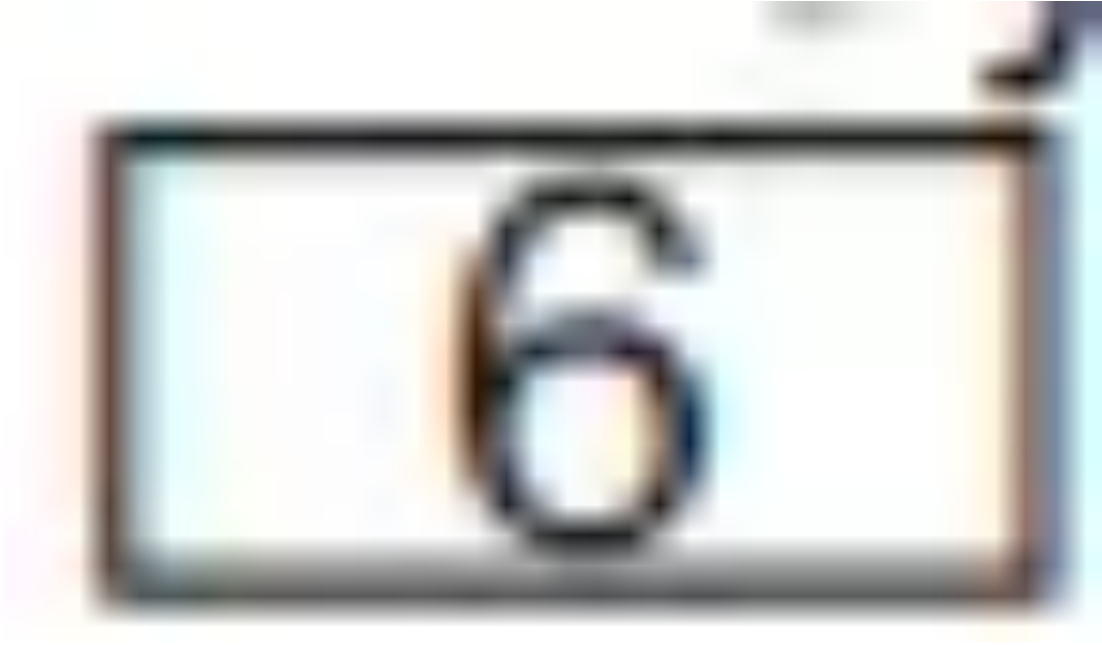

save setting.

to



## Care and Maintenance

Care and Maintenance A regular inspection and maintenance of your machine will help to prevent faults. This saves time and prevents future problems.

### Cleaning the dishwasher

- Regularly wipe the front of the appliance with a damp cloth - water and a small amount of liquid soap is adequate.
- For black stainless steel and anti-fingerprint surfaces, use a soft, dry towel. For stubborn dirt, use warm water diluted with a non-abrasive, mild cleansing soap. Never use stainless steel polish.
- For stainless steel appliances (excluding black stainless and anti-fingerprint), use a stainless steel polish to seal and protect the surface.

- Clean the outer edges of the inside door panel regularly to remove debris that may collect from normal loading. If spots begin to appear on the stainless steel, make sure the rinse aid dispenser is full and functioning properly.
- Clean the door seal regularly with a damp cloth to remove food particles that may collect from normal loading and cause odor. A soiled door seal may not seal properly.

#### **NOTICE**

- Never use a steam cleaner to clean your dishwasher. The manufacturer is not liable for any resulting damage.
- Do not use sponges as they could scratch the surfaces.
- Do not use bleach-based wipes as they could damage the surface or printing.
- Never use stainless steel polish on a black stainless finish or anti-fingerprint surfaces.

#### **WARNING**

##### **RISK OF EXPLOSION!**

■ When cleaning your dishwasher with any cleaning agent, remove all cookware, utensils or any foreign material from inside. Some cleaning agents are highly acidic and/or caustic alkaline, which can cause hydrogen gas to form if aluminum material is also inside the dishwasher tub. Hydrogen gas is explosive.

#### **WARNING**

Use caution when removing parts for cleaning as some debris may be sharp.

#### **Filters**

- The Bosch® filter system

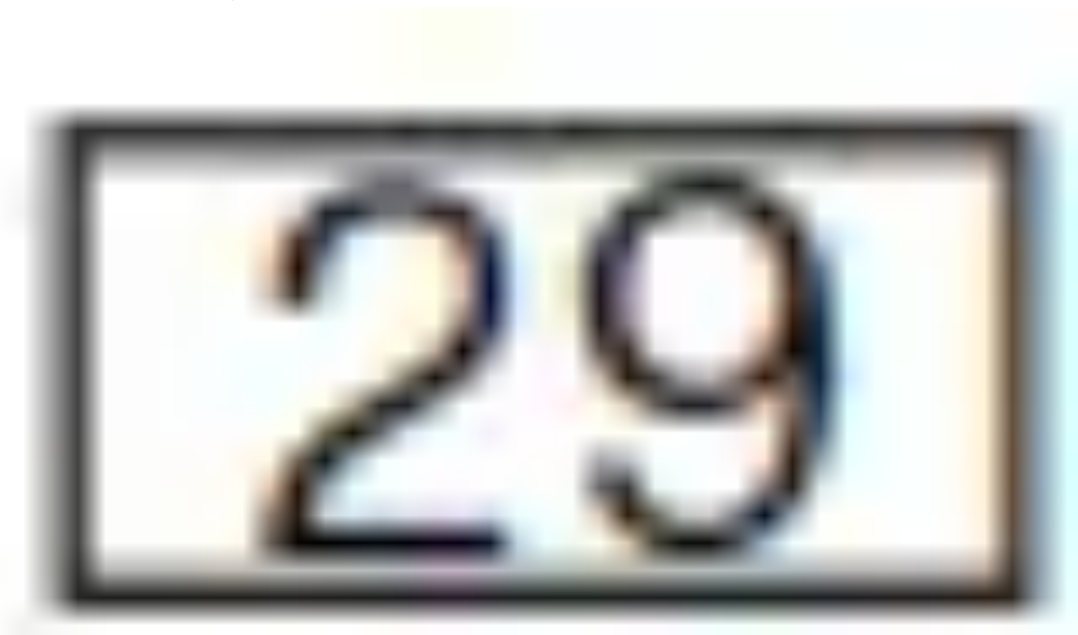

is designed to prevent the need to pre-rinse normally attached food soils from your dishes.

Simply scrape leftover food soils off of dishware before loading. This process will conserve time, water and the energy require to heat your household water supply.

- Your dishwasher filter system is designed to filter 100% of the water entering the spray arms to provide a continuous supply of clean water to remove food soils from your dishware.

### Filter components

The filter system

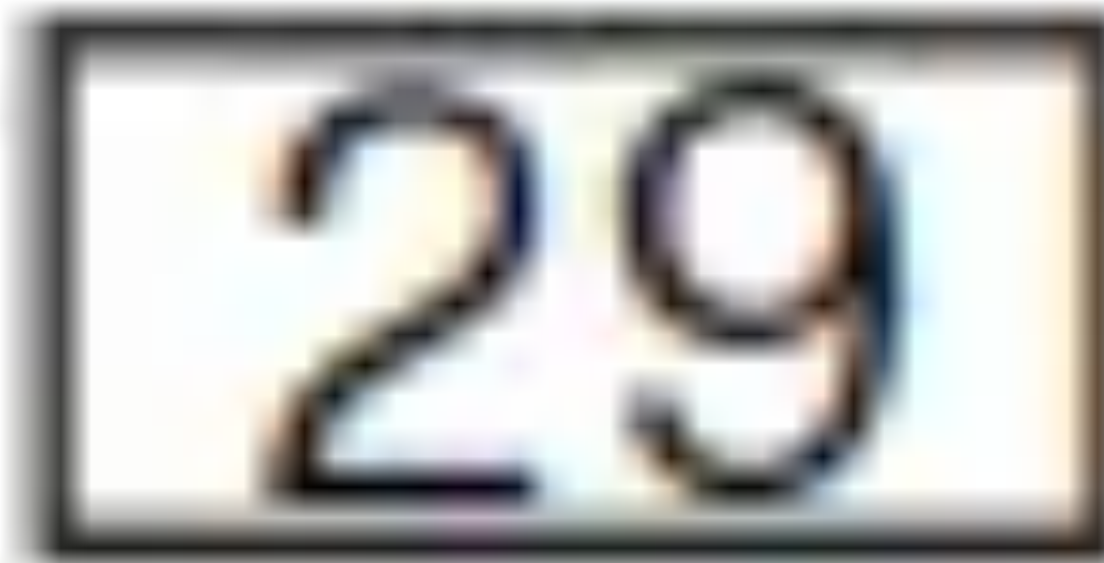

consists of three parts.

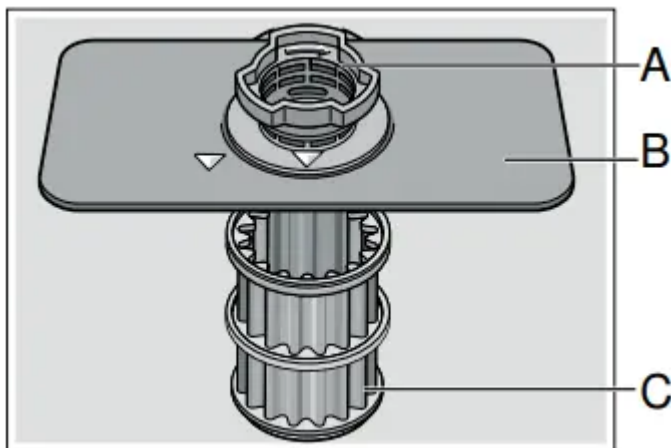

### A Large Object Trap

- Prevents objects that should not be placed in your dishwasher from damaging the dishwasher pump system or clogging your household drain.

## **B Flat Fine Filter**

- Prevents food particles from entering the wash chamber and directs particles toward the micro filter

## **C Micro Filter**

- Directs the smallest of particles to the household plumbing drain.

## **Cleaning intervals**

The filter system 29 is designed to minimize maintenance while providing premium cleaning performance and minimum energy consumption.

Depending on use habits and water hardness, the filter system will require some maintenance to sustain premium cleaning performance.

Your filter system may need to be cleaned when:

- You notice food soils remaining on the filter system or objects trapped in the Large Object Trap.
- A drop in cleaning performance or a gritty film forms on the dishware.

When washing normally attached food soils that have been scraped before loading, in a household that runs the dishwasher every other day, your filter should be cleaned:

**Note:** Clean the filter after washing loads with large amounts of food soils or loads with a heavy starch content, like potatoes and pasta, to maintain optimal performance.

**To check or clean the filter system:**

1. Unscrew the Large Object Trap as illustrated and remove the entire filter system.

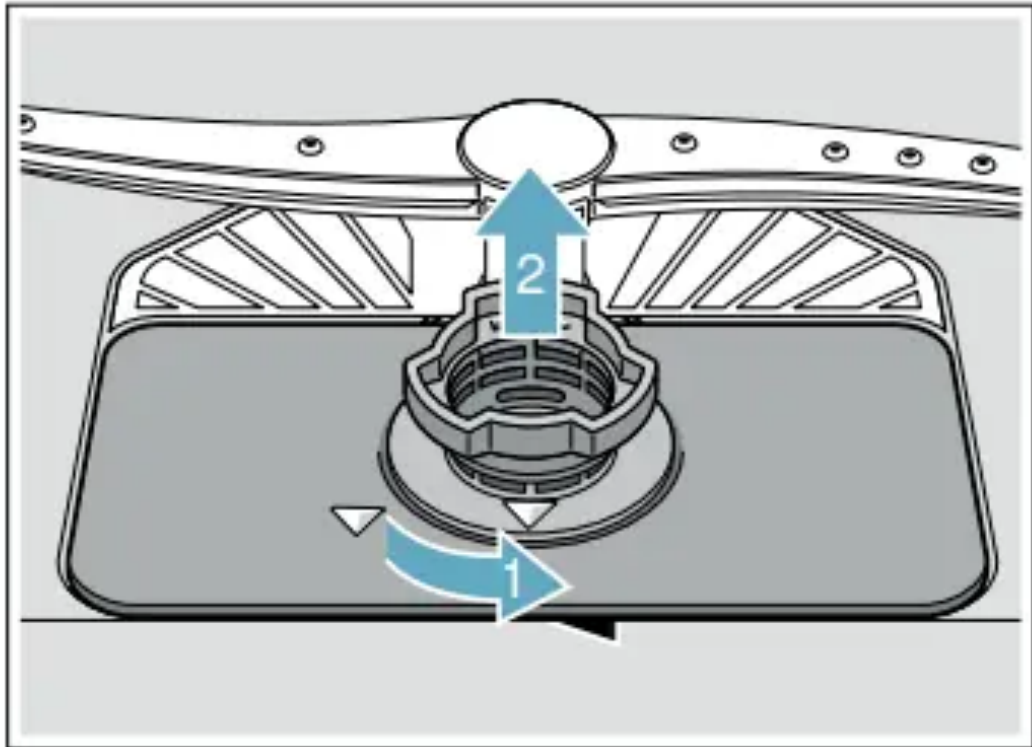

2. Remove the microfilter from the fine filter for easier cleaning.

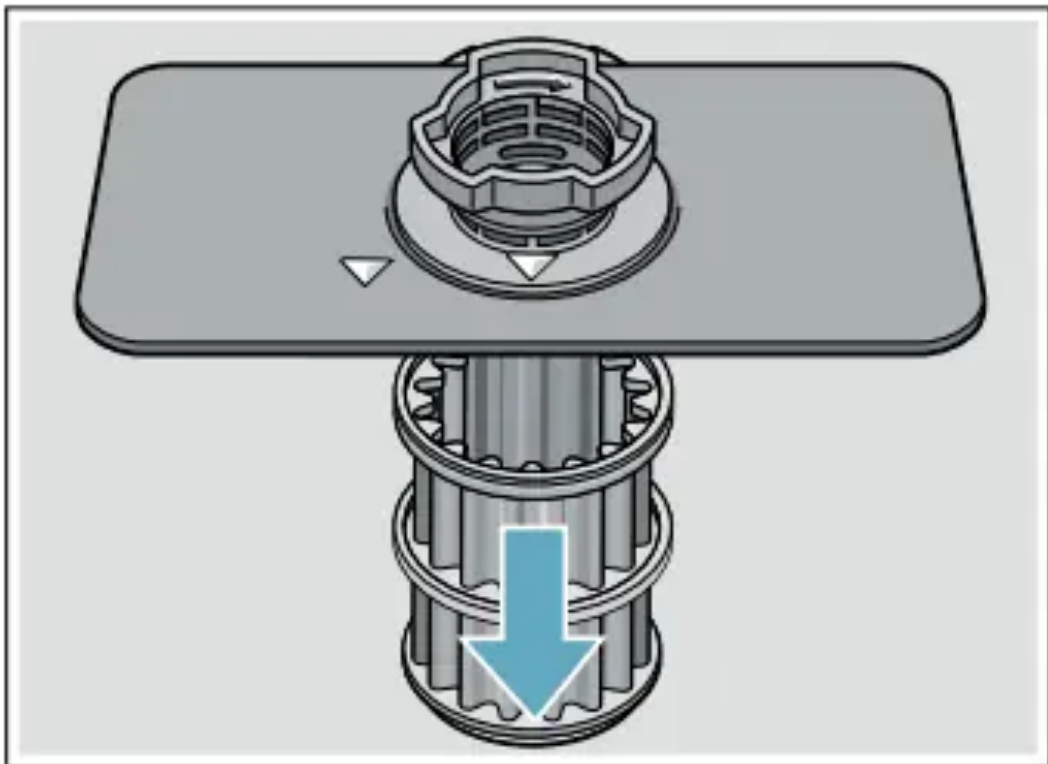

3. Rinse the filters under running water and use a soft brush to clean.

**Note:** do not use abrasive brushes or steel wool, etc., as they may damage the filter.

4. Reinstall the filter system in reverse sequence and lock into place by screwing the Large Object Trap until the marking arrows align.

### **Spray arms**

Check spray arms

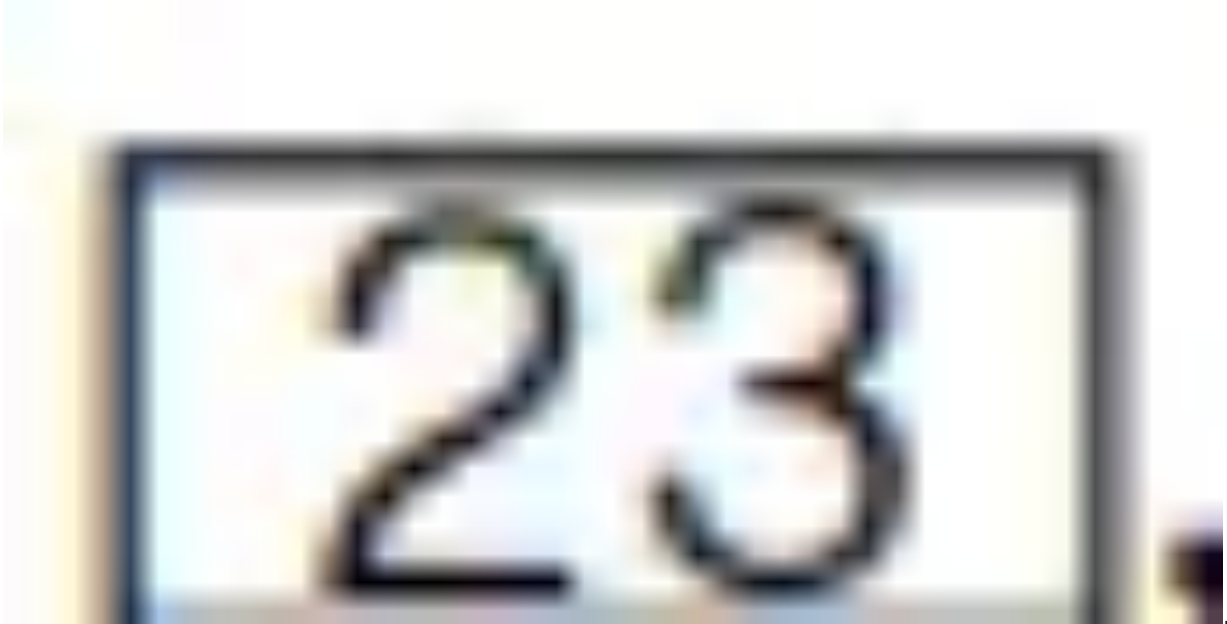



for

grease and limescale deposits. If you find such deposits:

- Fill detergent dispenser



with

detergent and start the appliance without utensils in the cycle with the highest rinsing temperature. → "Wash Cycle Information" on page 31

- Clean the appliance with detergents/appliance cleaners which are particularly suitable for use with dishwashers.

- Unscrew the upper spray arm

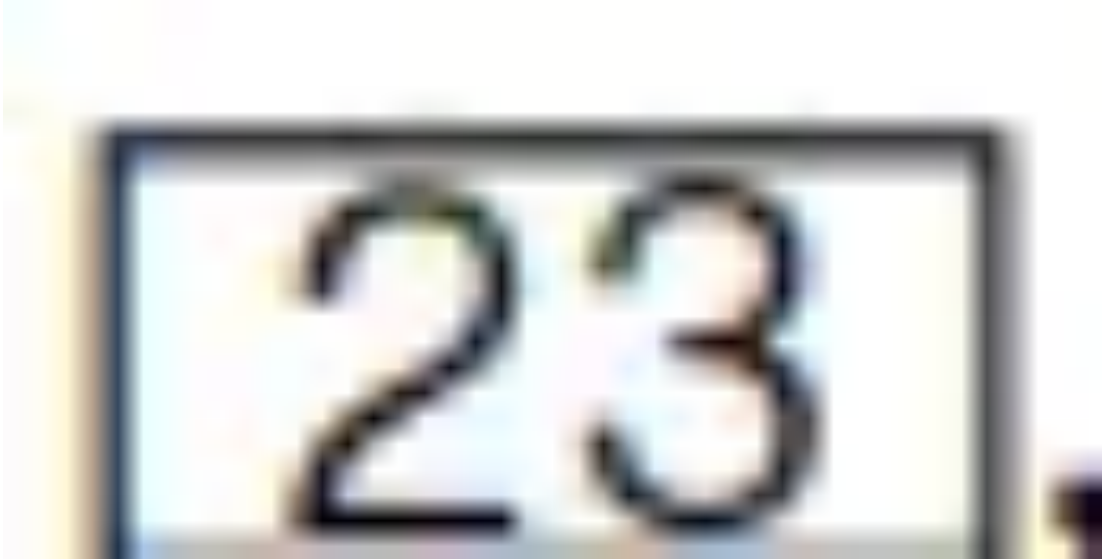

and

pull off the lower spray



arm as shown. Inspect for deposits.

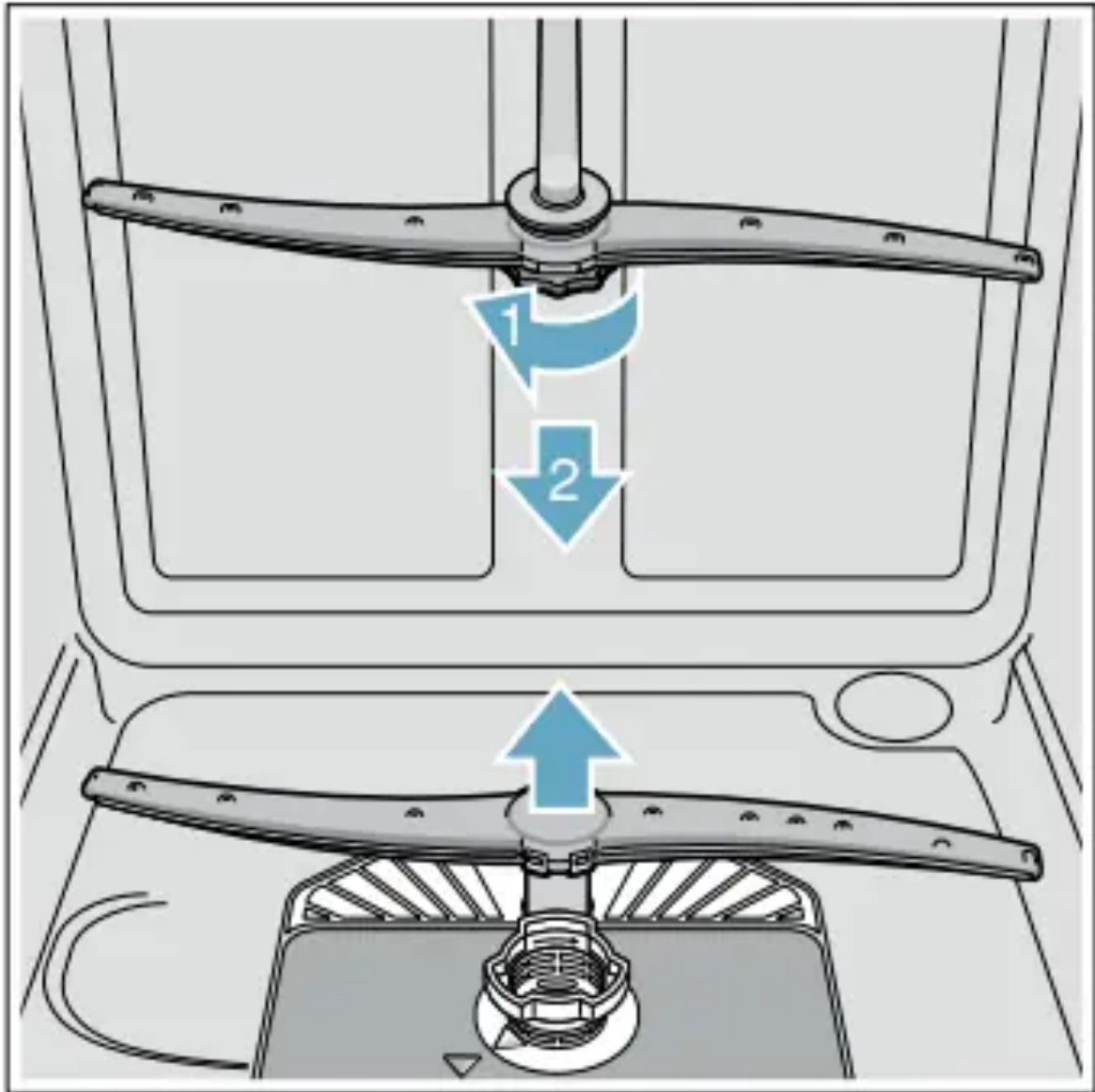

### Drain pump

Large food remnants in the rinsing water not retained by the filters may block the waste water pump. In this case:

- Disconnect the appliance from the power supply.
- Remove the filters. -> "Filters" on page 40
- Scoop out standing water - use a sponge if necessary.
- Using a spoon, pry off the pump cover until it clicks, then grip the cover and pull upward until it resists and then pull forward.

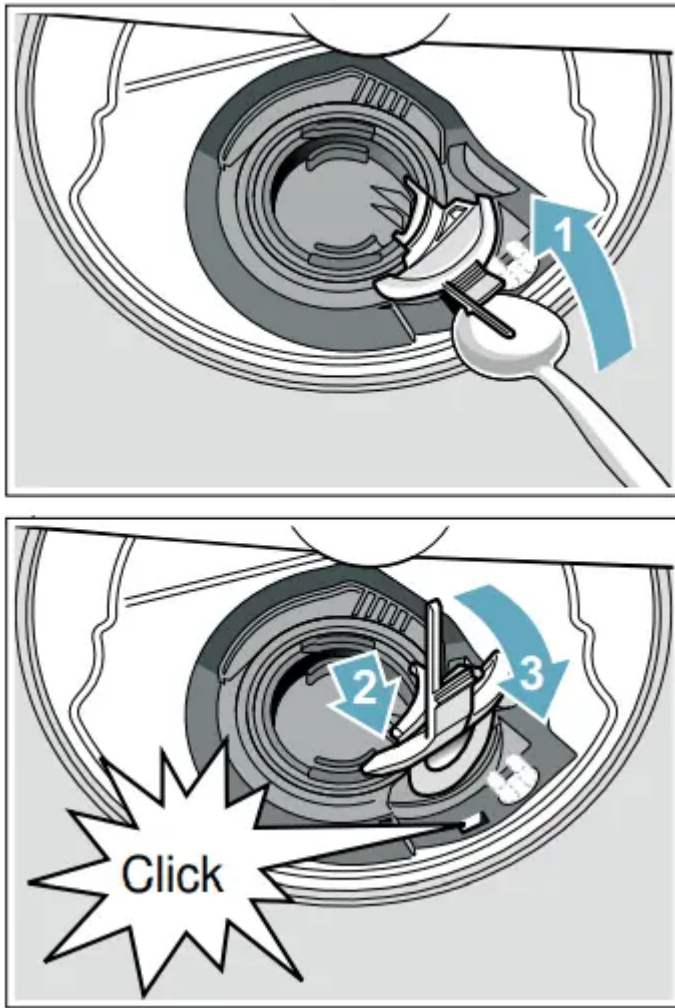

- Check inner compartment and remove any foreign objects.

**WARNING** Use caution when removing parts for cleaning as some debris may be sharp.

- Place cover in the original position, press down and engage.
- Reinstall filters.

**Note:** The drain pump will not work properly if the drain pump cover is not snapped in completely until it clicks.

## Preparing your unit for vacation

### NOTICE

Before leaving for vacation during warmer weather, besides turning off the main valve, also turn off water supply at the nearest point to the dishwasher. Do not leave soiled dishware in unit and leave door slightly open. During colder weather, please follow the instructions for winterizing your unit below.

### Winterizing your unit

### NOTICE

If your dishwasher will be unused for a period of time in a location that experiences freezing temperatures (holiday home or through a vacation period), have your dishwasher winterized by a professional service.



## **Troubleshooting**

Dishwashers may occasionally exhibit problems that are unrelated to a malfunction of the dishwasher itself. The following information may help you with a dishwasher problem without involving a repair professional.

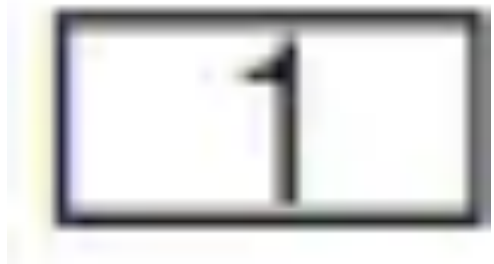
<b>Dishwasher does not start.</b>	Door may be ajar or not be properly latched.	Close door securely until door latch clicks.
	No power to the dishwasher (display won't come on). Fuse may have been blown, circuit breaker may have tripped, power cord may have been unplugged or dishwasher may have been turned off.	Replace blown fuse or reset tripped circuit breaker. Plug power cord into outlet securely. Press the on/off button  to turn the dishwasher on.
	Can't select a wash cycle since the previous wash cycle may not have finished or the dishwasher hasn't been reset.	Reset the dishwasher by pressing and holding the START button for at least three seconds.
	Delay start or Child lock may be activated.	Reset Delay start or Child lock functions (refer to the appropriate section in this manual). -> "Delay Start" on page 35
	The door may have been closed without selecting a wash cycle.	Select a wash cycle and close the door.
	Water supply may not be turned on or connected.	Check and turn on water supply.
<b>Wash cycle won't resume after door was opened and closed.</b>	The door has been open for more than 4 seconds after pressing the Start button.	Press Start button again and close the dishwasher door within 4 seconds (see "Protection against unintentional operation" section in this manual).
<b>Display does not illuminate.</b>	A fuse may have been blown or circuit breaker tripped.	Check the fuse or circuit breaker box and replace the fuse or reset the breaker if necessary
	Door not closed or latched.	Ensure door is properly latched and completely closed.

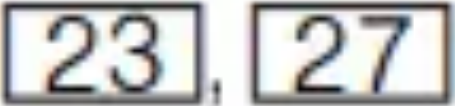
	<b>Note:</b> For models with controls on top of the door, the display only illuminates when the door is opened and controls are visible.	
<b>Dishwasher runs a long time.</b>	Incoming water is not warm enough.	Before starting a cycle, run hot water faucet at the sink closest to the dishwasher
	Cycle time depends on wash cycle chosen and amount of soil on dishes (dishwasher sensors increase cycle times to ensure dishes are clean when heavy soil is detected).	Scrape food off of dishes and use less intensive wash cycles.
	Rinse aid dispenser 32 is empty, or rinse aid setting = 0. Without rinse aid, wash cycle defaults to longest time with most number of washes and rinses.	Add rinse aid and change rinse aid setting depending on water hardness.
	Dishwasher is connected to cold water supply.	Connect dishwasher to hot water supply
<b>Dishes aren't clean enough</b>	Spray arms are blocked or misaligned where they cannot rotate freely.	Make sure spray arms  can rotate freely
	Little or no water spray due to clogged spray arm nozzle.	Clean out spray arm nozzles and filters of all debris and obstructions. -> "Spray arms" on page 41
	Little or no water spray due to clogged or misaligned filters 29.	Clean filters and make sure they're installed correctly. -> "Filter components" on page 40
		Space dishes apart so spray jets can reach the surface of the dishes and

	Dishes are nested or placed too closely together and racks are overfilled.	dishes don't contact each other. -> "Loading the Dishwasher" on page 15
	Improper or ineffective wash cycle or detergent used.	Choose a more intensive wash cycle and use appropriate dishwasher detergents. -> "Wash Cycle Information" on page 31
	Detergent is made less effective due to hard water	Install a water softener and choose a more intensive wash cycle.
<b>Removable spots or streaks on glasses and silverware.</b>	Too much rinse aid causes streaks and too little rinse aid can cause spots.	Add rinse aid and check rinse aid setting (recommended setting 4-5). -> "Rinse Aid" on page 13
	Mineral deposits from hard water.	Install a water softener.
	Water from top (3rd) or upper rack dripped on racks below.	Unload lower rack 1st, upper rack 2nd and top (3rd) rack last.
<b>Dishes not dry</b>	Rinse aid dispenser 32 is empty or incorrect rinse aid amount is set.	Add rinse aid or adjust setting - the use of rinse agent improves drying, use the Auto cycle, use the Sanitize option.
	Extra Dry heat option not chosen.*	Activate Extra Dry heat option.*
	Water collected in depressions on the dishes and silverware.	Arrange dishes in upper rack to slope so water can drain.
	Door was opened or dishes removed before wash cycle was completed.	Wait until wash cycle ends before opening door or removing dishes.
	Plastics don't absorb heat like cutlery or china and don't dry as well.	Use more intensive wash cycles (with hotter rinse water) or activate Extra Dry heat option.*
	Silverware not arranged properly in the silverware basket or top rack.	Arrange silverware properly and separate them so they don't contact each other.

<b>Odor</b>  <b>Note: Water testing is done in the factory. Occasionally water may still appear in dishwasher at purchase which may create an odor.</b>	Food debris in the dishwasher sump and door seal.	Clean sump filters, sump and door seal as needed. -> "Care and Maintenance" on page 39
	Food debris left on dishes too long.	Run dishwasher more frequently
	Not using rinse aid or using improper detergent.	Use rinse aid and the proper detergent.
	Residual standing water in the sump.	Make sure previous wash cycle has finished.
	Drain line is clogged or drain hose is kinked, clogged or blocked. Or drain hose was not installed with a high loop.	Unclog drain line or replace drain hose. Be sure drain hose is installed with high-loop.  <b>Note:</b> If odor still persists, run the Normal/ Regular cycle until it flushes and interrupt the cycle and place an 8 oz. cup of distilled white vinegar solution on the upper rack and then finish the cycle.
<b>Dishwasher isn't filling with water (or "Check water supply" display occurs)</b>	Water supply hose is kinked.	Install new supply hose (without kinks).
	Previous wash cycle was not completed or current wash cycle was interrupted.	Complete wash cycle or reset dishwasher.
	Delay start or Child lock may be activated.	Reset Delay start or Child lock functions (refer to the appropriate sections in this manual).
	Water supply line is clogged.	Unclog water line.
	Water supply was turned off.	Turn on water supply
<b>Fascia panel is discolored or scratched.</b>	Panel was cleaned with bleach-based wipes or abrasive cleaners/cleaning pads.	Use mild detergents with soft damp cloth.
<b>Noise from dishes rattling</b>		Load dishes properly into racks. -> "Loading the Dishwasher" on page 15

<b>or water striking tub walls.</b>	Dishes weren't loaded properly, allowing dishes to hit each other or spray arms.	
	Light dishes or lightly loaded racks allow dishes to move or water sprays to strike tubs.	Load more dishes or distribute dishes more evenly/securely in the dishwasher.
<b>Water leaks from tub or from around door.</b>	Suds from using the wrong detergent (i.e. dish) or overfilling/spilling rinse aid.	Use an appropriate dishwasher detergent, don't overfill rinse aid and clean any spilled rinse aid. If suds still persist, add one tablespoon of veg
	Door seal was misaligned or pulled from its track.	Make sure the door seal is securely inserted into its track.
	Condensation vent is blocked.	Clean out vent and move tall items like trays away from the vent.
	Improper installation.	Have an authorized service professional remount the dishwasher.
<b>White limescale on dishes, tub, racks or door</b>	White residue coats dishwasher interior and racks wheels squeak from lime scale deposits in hard water.	Use a dishwasher cleaner every few months. If dishwasher has a water softener, increase the setting.
	Hard water kept 3 in 1 detergent or Eco detergent from being effective.	Use separate dishwasher detergent, rinse aid and dishwasher softener salt (if dishwasher has a softener).
	Under dosing of detergent.	Use more detergent or change to a more effective detergent.
	Rinse temperature is too low.	Select more intensive wash cycles with higher washing temperatures.
<b>Detergent dispenser cover will not shut</b>	Cover guides are blocked by sticky detergent residue.	Remove detergent residue. → "Detergent" on page 27
<b>Unable to select desired cycle</b>	Previous cycle not finished.	→ "Operating the Dishwasher" on page 34

<p><b>Touch sensitive keys not activating easily or activating without being touched</b></p> <p><b>* optional feature which may or may not be included with your dishwasher.</b></p>	<p>Water or other liquid on the surface.</p>	<p>Wiping the fascia with a wet cloth may cause unwanted activation. wipe the fascia with a soft, dry cloth when possible. If you must use a damp cloth to clean, dry immediately. Never pour water on the controls.</p>
	<p>Touch keys not being activated properly.</p>	<p>Press the center of the touch key with the flat area of your fingertip. A beep will sound to indicate that the selection has been made. Touching the keys lightly should work.</p> <p>Note: There is a built-in delay to prevent someone from launching several actions at once by accidentally wiping their hand (or a cleaning cloth) across the control panel.</p>

**Warning**

This content is compiled from multiple sources and is provided for reference purposes only. It may not be complete or fully applicable to all situations. If you are unable to resolve your issue, please contact the product manufacturer or an authorized service provider for official support.

