

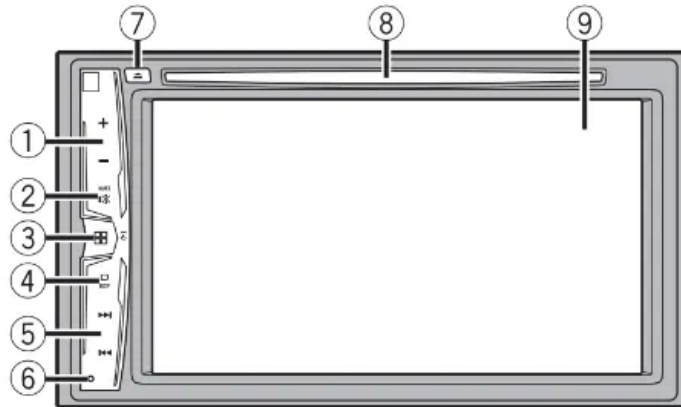





Parts and controls

Main unit



①	VOL (+/-)	
②	MUTE	
③		Press to display the top menu screen. Press and hold to power off. To power back on, press any button. NOTE The  icon appears when the power is on.
④	DISP	Press to turn the display on or off.

⑤	 or 	Performs manual seek tuning, fast forwards, reverse and track search controls. Press to answer or end a call.
⑥	RESET	Press to reset the microprocessor (page 11).
⑦		Refer to Inserting and ejecting a disc (page 25).
⑧	Disc-loading slot	
⑨	LCD screen	

Remote Control

201EX

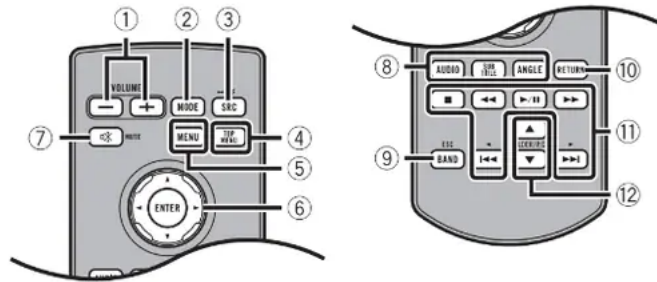

①	Volume (+/-)	
②	MODE	Press to turn the display on or off.
③	SRC	Press to cycle through all the available sources. Press and hold to turn the source off.
④	TOP MENU	Press to return to the top menu during DVD playback.
⑤	MENU	Displays the DVD menu during DVD playback.
⑥	Thumb pad	Use to select a menu on the DVD menu.
⑦	MUTE	
⑧	AUDIO SUBTITLE ANGLE	Press to change the audio language, subtitle language or viewing angle during DVD playback.
⑨	BAND/ESC	Press to select the tuner band when tuner is selected as a source. Press to switch between media file types when playing the following types of data: Disc, USB
⑩	RETURN	Press to return to the specified point and start playback from there.
⑪	▶/⏸	Press to pause or resume playback.
	◀◀ or ▶▶	For audio: Press and hold to perform fast reverse or fast forward. For video: Press to perform fast reverse or fast forward.
	◀◀ or ▶▶	Press to return to the previous track (chapter) or go to the next track (chapter). Press to answer or end a call.
	■	Press to stop playback. If you resume playback, playback will start from the point where you stopped. Press the button again to stop playback completely.
⑫	FOLDER/P.CH	Press to select the next or previous title or folder. Press to recall radio station frequencies assigned to preset channel keys. Press to answer or end a call.

Basic operation

Resetting the microprocessor

CAUTION

- Pressing the RESET button resets settings and recorded contents to the factory settings.
 - Do not perform this operation when a device is connected to this product.
 - Some of the settings and recorded contents will not be reset.

- The microprocessor must be reset under the following conditions:
 - Prior to using this product for the first time after installation.
 - If this product fails to operate properly.
 - If there appears to be problems with the operation of the system.

1. Turn the ignition switch OFF.
2. Press RESET with a pen tip or other pointed tools.

Settings and recorded contents are reset to the factory settings.

Preparing the remote control

Remove the insulation sheet before use.



How to replace the battery

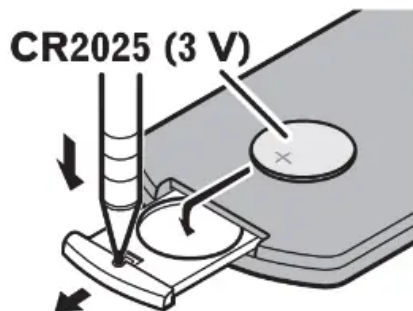

Insert the CR2025 (3 V) battery with the plus (+) and minus (-) poles orientated properly.

CAUTION

- Remove the battery if the remote control is not used for a month or longer.
- There is a danger of explosion if the battery is incorrectly replaced. Replace only with the same or equivalent type.
- Donot handle the battery with metallic tools.
- Do not store the battery with metallic objects.
- If the battery leaks, wipe the remote control completely clean and install a new battery.
- When disposing of used batteries, please comply with governmental regulations or environmental public institution's rules that apply in your country/area.
- Perchlorate Material - special handling may apply.

Using the remote control

Point the remote control in the direction of the front panel to operate.

NOTE

The remote control may not function properly in direct sunlight.

Important

- Do not store the remote control in high temperatures or direct sunlight.
- Do not let the remote control fall onto the floor, where it may become jammed under the brake or gas pedal.











Using the touch panel

You can operate this product by touching the keys on the screen directly with your fingers.

NOTE





To protect the LCD screen from damage, be sure to touch the screen only with your finger gently.

Common touch panel keys

	Switches between playback and pause.
 	
 	 Skips files (or tracks) forward or backward.
 	Performs fast reverse or fast forward. Touch again to change the playback speed.
	Stops playback.
Text information	When all characters are not displayed, the rests are automatically scrolled on the display. The characters are displayed by touching the text information. NOTE This function is available only when you stop your vehicle in a safe place and apply the parking brake.
	Returns to the previous screen.
	Close the screen.

Operating list screens

 abcdefghi	Touching an item on the list allows you to narrow down the options and proceed to the next operation.
---	--



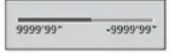

	<p>Appears when all characters are not displayed on the display area. If you touch the key, the rests are scrolled for display.</p> <p>NOTE This function is available only when you stop your vehicle in a safe place and apply the parking brake.</p>
	<p>Appears when items cannot be displayed on a single page. Touch  or  to view any hidden items.</p>



Operating the time bar

	<p>You can change the playback point by dragging the key.</p> <p>NOTE The time bar function may vary depending on the activating source.</p>
---	--

Top menu screen



	<p>Source icons</p>
	<p>Setting the time and date (page 45)</p>
	<p>Settings (page 34) and Favorite menu (page 44)</p>
	<p>Hands-free phoning (page 17)</p>
	<p>AV source off</p>

	<p>If you select , you can turn off almost all functions. The unit turns on by operating following functions:</p> <ul style="list-style-type: none"> • An incoming call is received (only for hands-free phoning via Bluetooth). • A rear view camera image is input when the vehicle is in reverse. • A button on this unit is pressed. • The ignition switch is turned off (ACC OFF), then turned on (ACC ON).
---	--

Bluetooth

Bluetooth connection

1 Turn on the Bluetooth function on the device.

2 Press

3 Touch then

The Bluetooth screen appears.

4 Touch [Connection].

5 Touch

The unit starts to search for available devices, then displays them in the device list.

6 Touch the Bluetooth device name.

After the device is successfully registered, a Bluetooth connection is established by the system.

Once the connection is established, the device name is displayed on the list.

NOTE

- If five devices are already paired, [Memory Full] is displayed. Delete a paired device first
- If your device supports SSP (Secure Simple Pairing), a six-digit number appears on the display of this product. Touch [Yes] to pair the device.
- is invalid when the device is already connected, during connection or disconnected.

TIPS

The Bluetooth connection can also be made by detecting this product from the Bluetooth device. Before registration, make sure that [Visibility] in the [Bluetooth] menu is set to [On] (page 20). For details on Bluetooth device operations, refer to the operating instructions supplied with the Bluetooth device.

Bluetooth settings

1. Press

2. Touch then

Switching the connected Bluetooth device

You can switch among the connected Bluetooth devices using the switch devices key in the Bluetooth menu.

- You can register up to three Bluetooth devices on this product (page 15).
- The Bluetooth audio player can be switched to other Bluetooth devices on the Bluetooth audio playback screen.

- Only one device can be connected as a hands-free phoning.

Hands-free phoning

To use this function you need to connect your cellular phone to this product via Bluetooth in advance (page 19).

CAUTION

For your safety, avoid talking on the phone as much as possible while driving.











Making a phone call

1 Press 

2 Touch 

The phone menu screen appears.

3 Touch one of the call icons on the phone menu screen.

	<p>The following items are displayed.</p> <ul style="list-style-type: none"> • Name of the current cellular phone • List number of the current cellular phone • Reception status of the current cellular phone • Battery status of the current cellular phone
	<p>Initial searches the phone book. Each time you press the button, English and system language may switch depending on the system language setting. Touch the list area to stop initial search.</p>
	<p>Using preset dial list (page 18)</p>
	<p>Using phone book Select a contact from the phone book. Touch the desired name on the list then select the phone number.</p> <p>TIPS</p> <ul style="list-style-type: none"> • The contacts on your phone will be automatically transferred to this product. • Update the phone book manually.
	<p>Using call history Make a phone call from the received call , dialed call , or missed call .</p>
	<p>Direct phone number input Enter the number keys to enter the phone number then touch  to make a call.</p>

Using the preset dial lists

Registering a phone number

You can easily store up to six phone numbers per device as presets.

1. Press 

2. Touch

3. Touch or

On the [Phone Book] screen, touch the desired name to display the contact's phone number.

4. Touch 

Dialing from the preset dial list

1. Touch 

2 Touch the desired entry on the list to make a call.

The dial screen appears and dialing starts.

Deleting a phone number

1 Press 

2 Touch

3 Touch 

4 Touch 

5 Touch [Yes].

Receiving a phone call

1 Touch answer the call.

Touch  end the call.

Setting the private mode

During a conversation, you can switch to private mode (talk directly on your cellular phone).

1. Touch  **or**  return private mode on or off.

Adjusting the other party's listening volume

This product can be adjusted to the other party's listening volume.

1. Touch  to switch between the three volume levels.

Notes for hands-free phoning

General notes

- Connection to all cellular phones featuring Bluetooth wireless technology is not guaranteed.
- The line-of-sight distance between this product and your cellular phone must be 10 meters or less when sending and receiving voice and data via Bluetooth technology.
- With some cellular phones, the ring sound may not be output from the speakers.
- If private mode is selected on the cellular phone, hands-free phoning may be disabled.

Registration and connection

- Cellular phone operations vary depending on the type of cellular phone. Refer to the instruction manual that came with your cellular phone for detailed instructions.
- When phone book transfer does not work, disconnect your phone and then perform pairing again from your phone to this product.

Making and receiving calls

- You may hear a noise in the following situations:
 - When you answer the phone using the button on the phone.
 - When the person on the other end of the line hangs up the phone.
- If the person on the other end of the line cannot hear the conversation due to an echo, decrease the volume level for hands-free phoning.
- With some cellular phones, even after you press the accept button on the cellular phone when a call comes in, hands-free phoning may not be performed.
- The registered name will appear if the phone number is already registered in the phone book. When the same phone number is registered under different names, only the phone number will be displayed.

The received call and dialed number histories

- You cannot make a call to the entry of an unknown user (no phone number) in the received call history.
- If calls are made by operating your cellular phone, no history data will be recorded in this product.

Phone book transfers

- If there are more than 1000 phone book entries on your cellular phone, not all entries may download completely.
- Depending on the phone, this product may not display the phone book correctly.

- If the phone book in the phone contains image data, the phone book may not be transferred correctly.
- Depending on the cellular phone, phone book transfer may not be available.

Bluetooth audio

Before using the Bluetooth audio player, register and connect the device to this product

NOTE

- Depending on the Bluetooth audio player connected to this product, the available operations with this product may be limited to the following two levels:
 - A2DP (Advanced Audio Distribution Profile): Only playing back songs on your audio player is possible.
 - A2DP and AVRCP (Audio/Video Remote Control Profile): Playing back, pausing, selecting songs, etc, are possible.
- Depending on the Bluetooth device connected to this product, the available operations with this product may be limited or differ from the descriptions in this manual.
- While you are listening to songs on your Bluetooth device, refrain from operating the phone function as much as possible. If you try operating, the signal may cause noise for song playback.
- When you are talking on the Bluetooth device connected to this product via Bluetooth, it may pause playback.

1.  Press 

2. Touch then The system setting screen appears.

3. Touch [AV Source Settings].





4. Confirm that [Bluetooth Audio] is turned on.

5.  Press 

6. Touch [Bluetooth Audio]. The Bluetooth audio playback screen appears.

Basic operation

Description of Bluetooth audio playback screen

	Track number indicator
	Sets a repeat play range.
	Plays files in random order.
	Selects a file or folder from the list to playback. NOTE This function is available only when the AVRCP version of the Bluetooth device is 1.4 or higher.
	Switches among the Bluetooth devices when the devices are connected to this product via Bluetooth (page 17).

AV source

Selecting a source

Source on the AV source selection screen

1. Press
2. Touch the source icon.

When you select , the AV source is turned off.

Source on the source list

1. Touch on the AV Source key
2. Touch the source key.

When you select [Source OFF], the AV source is turned off.

Radio









Starting procedure

1. 
Press
2. Touch [Radio].

The Radio screen appears.

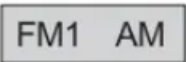
Basic operation

Description of Radio screen

	 Recalls the preset channel stored to a key from memory.
	 Stores the current broadcast frequency to a key.
	Displays the preset channel list. Select an item on the list ([1] to [6]) to switch to the preset channel.
	Selects the FM1, FM2, FM3, or AM band.
	Performs BSM (best stations memory) function (page 24).
	 Manual tuning
	 Seek tuning or non stop seek tuning Releasing the key in a few seconds skips to the nearest station from the current frequency. Keep holding the key for long seconds to perform, performs non stop seek tuning.

Storing the strongest broadcast frequencies (BSM)

The BSM (best stations memory) function automatically stores the six strongest broadcast frequencies under the preset channel keys [1] to [6].

NOTES

- Storing broadcast frequencies with BSM may replace those you have already saved.
- Previously stored broadcast frequencies may remain stored if the number of frequencies stored has not reached the limit.

1.  Touch  to begin search.

While the message is displayed, the six strongest broadcast frequencies will be stored under the preset channel keys in the order of their signal strength. **Storing the strongest broadcast frequencies (BSM)**

To cancel the storage process

1. Touch [Cancel].

Radio settings

1. Press 

2. Touch then The system setting screen appears.
3. Touch [AV Source Settings].
4. Touch [Radio settings]

The menu items vary according to the source.

Menu Item	Description
[Local] [Off] FM: [Level1] [Level2] [Level3] [Level4] AM: [Level1] [Level2]	Local seek tuning allows you to only tune into radio stations with sufficiently strong signals. NOTE The FM [Level4] (AM [Level2]) setting allows reception of only stations with the strongest signals.

Disc

Inserting and ejecting a disc

You can play a normal music CD, Video-CD, or DVD-Video using the built-in drive of this product.

CAUTION

Do not insert anything other than a disc into the disc-loading slot.

Inserting a disc

1. Insert a disc into the disc-loading slot.

The source changes and then playback will start.

NOTE

If the disc is already set, select [Disc] as the playing source.





Ejecting a disc

1. Press .

Basic Operation

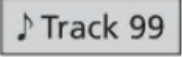
Audio source

Description of Audio source screen









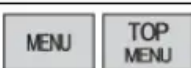
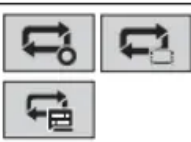

	Track number indicator
	Sets a repeat play for the current disc/the current track.
	Plays or does not play tracks in random order.
	Selects a track from the list. Touch a track on the list to play back.

Video source

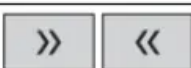
Description of Video source screen

TIP

Touch anywhere on the screen, the touch panel keys appear.

	<p>Performs frame-by-frame playback.</p> 
	<p>Performs slow-motion playback. Each time you touch , it changes the speed in four steps in the following order: 1/16 -> 1/8 -> 1/4 -> 1/2</p> <p>TIP Reverse slow-motion playback is only for Video CD.</p>
	<p>Displays the DVD menu.</p> <p>NOTE This function may not work properly with some DVD disc content. In that case, use touch panel keys to operate the DVD.</p>
	<p>Sets a repeat play for all files/the current chapter/the current title.</p>
	<p>Switches the audio/subtitle language.</p>
	<p>Displays the hidden function bar.</p>
	<p>Searches for the part you want to play. Touch [Title], [Chapter], [10Key], or [Track] then input the desired number from [0] to [9]. To start playback from the number you registered, touch .</p> <p>TIPS</p> <ul style="list-style-type: none"> • To cancel an input number, touch [C]. • For DVD-Videos, you can select [Title], [Chapter] or [10Key]. • For Video-CDs, you can select [Track] or [10Key].*
	<p>Selects the audio output from [L+R], [Left], [Right], [Mix]. This function is available for Video-CDs and DVDs recorded with LPCM audio.</p>
	<p>Changes the viewing angle (Multi-angle). This function is available for DVDs featuring multi-angle recordings.</p>
	<p>Resumes playback (Bookmark). This function is available for DVD-Video. You can memorize one point as a Bookmark for a disc (up to five discs). To clear the bookmark on the disc, touch and hold this key.</p>
	<p>Returns and begins playback from the specified point. This function is available for DVD-Video and Video-CDs featuring PBC (playback control).</p>

* PBC (playback control) only

Compressed files

Inserting and ejecting media

You can play compressed audio, compressed video, or still image files stored in a disc or an external storage device.

CAUTION

Do not insert anything other than a disc into the disc-loading slot.

Inserting a disc

1. Insert a disc into the disc-loading slot.

The source changes and then playback will start.

NOTE

If the disc is already set, select [Disc] as the playing source.

Ejecting a disc

1. Press 

Plugging a USB storage device

1. Pull out the plug from the USB port of the USB cable.
2. Plug a USB storage device into the USB cable.

NOTE

- This product may not achieve optimum performance with some USB storage devices.
- Connection via a USB hub is not possible.
- A USB cable is required for connection.

Unplugging a USB storage device

1. Pull out the USB storage device from the USB cable.

NOTES

- Check that no data is being accessed before pulling out the USB storage device.
- Turn off (ACC OFF) the ignition switch before unplugging the USB storage device.

Starting procedure

For Disc

1. Insert the disc

TIP

If the disc is already set, select [Disc] as the playing source.

For USB

1. Plug the USB storage device into the USB cable









TIP

If the USB is already set, select [USB] as the playing source.

Basic operation

Audio source

Description of Audio source screen (Example: USB)

	Sets a repeat play range for all files/the current folder/the current file. NOTE The types of repeat play range depend on the source.
	Plays files or does not play in random order.
	Displays the hidden function bar.
	Switches the following media file types. [Music]: Compressed audio files [Video]: Compressed video files [CD-DA]: Audio data (CD-DA) [Photo]: Image files
	Selects a file from the list. Touch a file on the list to playback. TIP Touching a folder on the list shows its contents. You can play a file on the list by touching it.
	When you touch the memory select icon while connecting an Android device, it switches between internal memory and external memory.
	Selects the previous folder or the next folder.
	Switches the current music information display.

Video source

Description of Video source screen (Example: Disc)

TIP

Touch anywhere on the screen, the touch panel keys appear.

		Performs frame-by-frame playback.
		Performs slow-motion playback.
	Sets a repeat play range for all files/the current folder/the current file.	
	NOTE The types of repeat play range depend on the source.	
		Switches the audio/subtitle language.
	Switches the following media file types. [Music]: Compressed audio files [Video]: Compressed video files [CD-DA]: Audio data (CD-DA) [Photo]: Image files	
	Selects a file from the list. Touch a file on the list to playback. TIP Touching a folder on the list shows its contents. You can play a file on the list by touching it.	

Still image source

Description of Still image screen

TIP

Touch anywhere on the screen, the touch panel keys appear.

	Selects the previous folder or the next folder.
	Rotates the displayed picture 90° clockwise.
	Sets a repeat play range for all files/the current folder.
	Plays all files in the current repeat play range or does not play them in random order.
	Switches the following media file types. [Music]: Compressed audio files [Video]: Compressed video files [Photo]: Image files
	Selects a file from the list. Touch a file on the list to playback. TIP Touching a folder on the list shows its contents. You can play a file on the list by touching it.

AUX

You can display the video image output by the device connected to video input.



CAUTION

For safety reasons, video images cannot be viewed while your vehicle is in motion. To view video images, stop in a safe place and apply the parking brake.

NOTE

A Mini-jack AV cable (sold separately) is required for connection. For details, refer to the Installation Manual.

Starting procedure

1. Press .
2. Touch then
3. Confirm that [AUX Input] is turned on.
4. Press .
5. Touch [AUX].

The AUX screen appears.

Basic operation

AUX screen

Description of AUX screen

TIPS

- Touch anywhere on the screen, the touch panel keys appear.
- You can set the screen size for the video image (page 45).



Switches between the video input and audio input.

Troubleshooting

If you have problems operating this product, refer to this section. The most common problems are listed below, along with likely causes and solutions. If a solution to your problem cannot be found here, contact your dealer or the nearest authorized Pioneer service facility.

Common problems

A black screen is displayed, and operation is not possible using the touch panel keys.

- [Power OFF] mode is on.
 - Press any button on this product to release the mode.

Problems with the AV screen

CD or DVD playback is not possible.

- The disc is inserted upside down.
 - Insert the disc with the label upward.
- The disc is dirty.
 - Clean the disc.
- The disc is cracked or otherwise damaged.
 - Insert a normal, round disc.
- The files on the disc are in an irregular file format.
 - Check the file format.
- The disc format cannot be played back.
 - Replace the disc.
- The loaded disc is a type this product cannot play.
 - Check what type of disc it is.

The screen is covered by a caution message and the video cannot be shown.

- The parking brake lead is not connected or the parking brake is not applied.
 - Connect the parking brake lead correctly, and apply the parking brake.
- The parking brake interlock is activated.
 - Park your vehicle in a safe place and apply the parking brake.

No video output from the connected equipment.

- The [AV Input] or [AUX Input] setting is incorrect.
 - Correct the settings.

The audio or video skips.

- This product is not firmly secured.
 - Secure this product firmly.

No sounds are produced. The volume level will not rise.

- Cables are not connected correctly.
 - Connect the cables correctly.
- The system is performing still, slow motion, or frame-by-frame playback with DVD-Video.
 - There is no sound during still, slow motion, or frame-by-frame playback with DVD-Video.
- The system is paused or performing fast reverse or forward during the disc playback.
- For the media other than music CD (CD-DA), there is no sound on fast reverse or forward.

The icon  is displayed, and operation is impossible.

- The operation is not compatible with the video configuration.
 - The operation is not possible. (For example, the DVD playing does not feature that angle, audio system, subtitle language, etc.)

Random playback in Music Browse mode is released in the USB storage device.

- Random playback in Music Browse mode is canceled after the ignition switch is turned off {ACC OFF).
 - Switch to Music Browse mode again and turn on random playback.

The picture stops (pauses) and this product cannot be operated.

- The reading of data is impossible during disc playback.
 - Stop playback once, then restart.

The picture is stretched, with an incorrect aspect ratio.

- The aspect setting is incorrect for the display.
 - Select the appropriate setting for that image.

A parental lock message is displayed and DVD playback is not possible.

- The parental lock is on.
 - Turn the parental lock off or change the level.

The parental lock for DVD playback cannot be canceled.

- The code number is incorrect.
 - Input the correct code number.

Playback is not with the audio language and subtitle language settings selected in [DVD Setup].

- The DVD playing does not feature dialog or subtitles in the language selected in [DVD Setup].
 - Switching to a selected language is not possible if the language selected in [DVD Setup] is not recorded on the disc.

The picture is extremely unclear/ distorted and dark during playback.

- The disc features a signal to prohibit copying. (Some discs may have this.)
 - Since this product is compatible with the copy guard analog copy protect system, the picture may suffer from horizontal stripes or other imperfections when a disc with that kind of protection signal is viewed on some displays. This is not a malfunction.

iPod cannot be operated.

- The iPod is frozen.
 - Reconnect the iPod with the USB interface cable for iPod/iPhone.
 - Update the iPod software version.
- An error has occurred.
 - Reconnect the iPod with the USB interface cable for iPod/iPhone.
 - Park your vehicle in a safe place, and then turn off the ignition switch (ACC OFF). Subsequently, turn the ignition switch to on (ACC ON) again.
 - Update the iPod software version.
- Cables are not connected correctly.
 - Connect the cables correctly.

Sound from the iPod cannot be heard.

- The audio output direction may switch automatically when the Bluetooth and USB connections are used at the same time.
 - Use the iPod to change the audio output direction.

No back camera image when the vehicle is in reverse.

- The back camera input setting on the receiver is set to Off.
 - Change the back camera setting to On in the settings menu. (Refer to the System Settings section of this manual to adjust.)

- The camera input may be loose or not connected.
 - Check the connection and make sure the male end of the camera is connected to the brown input on the back of the receiver. (Refer to the installation manual.)
- The reverse lead on the receiver may not be connected to the proper wire at the reverse lamp.
 - Check the connection and make sure that the violet/white lead of the receiver is connected to the lead whose voltage changes when the shift lever is put in reverse. (Refer to the installation manual.)

Black screen displayed when the vehicle is in reverse, with no camera installed.

- Back camera input is set to On.
 - Turn the setting to Off in the settings menu. (Refer to the System Settings section of this manual to adjust.)

Back image displayed when vehicle is not in reverse.

- The camera polarity is not set properly in the Camera settings menu.
 - Review System Settings section of this manual for steps to switch the camera polarity. Park in a safe place, then while keeping your foot firmly on the brake, put the vehicle in reverse, access the System Settings menu, and change the camera polarity setting. Put vehicle back in park. (Refer to the System Settings section of this manual to adjust.)

Problems with the phone screen

Dialing is impossible because the touch panel keys for dialing are inactive.

- Your phone is out of range for service.
 - Retry after re-entering the range for service.
- The connection between the cellular phone and this product cannot be established.
 - Perform the connection process.
- Of the two cellular phones connected to this product at the same time, if the first phone is dialing, ringing or a call is in progress, dialing cannot be performed on the second phone.
 - When the operation on the first of the two cellular phones is completed, use the switch devices key to switch to the second phone and then dial.

Error messages

When problems occur with this product, an error message appears on the display.



Refer to the table below to identify the problem, then take the suggested corrective action. If the error persists, record the error message and contact your dealer or your nearest Pioneer service center.

Common

AMP Error

- This product fails to operate or the speaker connection is incorrect; the protective circuit is activated.
 - Check the speaker connection. If the message fails to disappear even after the engine is switched off/on, contact your dealer or an authorized Pioneer Service Station for assistance.se log in to the Pandora application.

Disc

Error-02-XX/FF-FF

- The disc is dirty.
 - Clean the disc.
- The disc is scratched.
 - Replace the disc.
- The disc is loaded upside down.
 - Check that the disc is loaded correctly.
- There is an electrical or mechanical error.
 - Press the RESET button.

Skipped

- The inserted disc contains DRM protected files.
 - The protected files are skipped.

Protect

- All the files on the inserted disc are embedded with DRM.
 - Replace the disc.

TEMP

- The temperature of this product is outside the normal operating range.
 - Wait until this product returns to a temperature within the normal operating limits.

USB storage device

Error-02-9X/-DX

- Communication failed.
 - Turn the ignition switch OFF and back ON.
 - Disconnect the USB storage device.
 - Change to a different source. Then, return to the USB storage device.

Skipped

- The connected USB storage device contains DRM protected files.
 - The protected files are skipped.

Protect

- All the files on the connected USB storage device are embedded with DRM.
 - Replace the USB storage device.

iPod

Error-02-6X

- iPod failure.
 - Disconnect the cable from the iPod. Once the iPod's main menu is displayed, reconnect the iPod and reset it.

Error-02-60

- The iPod firmware version is old.
 - Update the iPod version.

Bluetooth

Error-10 .

- The power failed for the Bluetooth . module of this product.
 - Turn the ignition switch to OFF and then to ON.

If the error message is still displayed after performing the above action, please contact your dealer or an authorized Pioneer Service Station.

Handling and care of discs

Some basic precautions are necessary when handling your discs.

Built-in drive and care

- Use only conventional, fully circular discs. Do not use shaped discs.
- Do not use cracked, chipped, warped, or otherwise damaged discs as they may damage the built-in drive.

- Use 12-cm discs. Do not use 8-cm discs or an adapter for 8-cm discs.
- When using discs that can be printed on label surfaces, check the instructions and the warnings of the discs. Depending on the discs, inserting and ejecting may not be possible. Using such discs may result in damage to this equipment.
- Do not attach labels, write on or apply chemicals to the surface of the discs.
- Do not attach commercially available labels or other materials to the discs.
- To clean a disc, wipe it with a soft cloth, moving outward from the center.
- Condensation may temporarily impair the built-in drive's performance.
- Playback of discs may not be possible because of disc characteristics, disc format, recorded application, playback environment, storage conditions and so on.
- Road shocks may interrupt disc playback.
- Read the precautions for discs before using them.

Ambient conditions for playing a disc

- At extremely high temperatures, a temperature cutout protects this product by switching it off automatically.
- Despite our careful design of the product, small scratches that do not affect actual operation may appear on the disc surface as a result of mechanical wear, ambient conditions for use or handling of the disc. This is not a sign of the malfunction of this product. Consider it to be normal wear and tear.

Warning

This content is compiled from multiple sources and is provided for reference purposes only. It may not be complete or fully applicable to all situations. If you are unable to resolve your issue, please contact the product manufacturer or an authorized service provider for official support.