

Safety Precautions

When using your this Air Purifier (appliance), basic safety precautions should always be followed to reduce the risk of fire, electric shock, and/ or injury to person. Incorrect operation due to ignoring instructions may cause harm or damage.

- Read all instructions before using the appliance.
- This appliance has a polarized plug (one blade is wider than the other). To reduce the risk of electric shock, connect the plug to properly polarized outlet only. No other appliance should be plugged into the same outlet. Be sure that the plug is fully inserted into the receptacle.
- **WARNING:** To reduce the risk or electric shock, **DO NOT** use this fan with any solid-state speed control device.
- Unplug the appliance from power source before moving the appliance.
- **DO NOT** touch the power plug with wet hands.
- **DO NOT** operate this appliance with a damaged cord.
- If the cord is damaged, contact hOme™ customer service at 1.800.898.3002 to avoid a hazard.
- The appliance must be positioned so that the plug is accessible.
- **DO NOT** run the power cord over carpeting or other heat insulators. **DO NOT** cover the cord. Keep the cord away from traffic areas, and **DO NOT** submerge in water or any other liquid.
- We **DO NOT** recommend the use of an extension cord, as it may overheat and become a risk of fire.
- Never use the power cord to pick up, carry, drag, pull, or lift the appliance. **DO NOT** pull the cord against or around sharp corners and edges. This could result in injury to the user or damage to the cord.
- Unplug the appliance before cleaning or making any repairs or servicing.
- **DO NOT** allow children to operate the appliance without adult supervision.
- This appliance is not suitable for the disabled person, person with perceptual disturbance, or person with intellectual disabilities.
- **DO NOT** clean your appliance with flammable fluids.

The fumes can create a fire hazard or explosion.

- **DO NOT** tip over the appliance. **DO NOT** sit on or lean on the appliance.
- **DO NOT** use the appliance in bathrooms or other humid environments.
- **DO NOT** use the appliance under direct sunlight, or heating source.

- It is forbidden to use chlorine or acid detergent.
- It is forbidden to put foreign objects into the air inlet, outlet and other openings.
- DO NOT use the appliance near fireplaces or in areas where flammable or combustible vapors or appliances may exist.
- This appliance operates at 120V~/60Hz only. DO NOT use the power socket for connecting equipment exceeding equipment rated value.
- DO NOT disassemble or refit the air purifier arbitrarily.
- Regularly clean the power plug.
- The appliance must be placed on a flat firm surface.
- DO NOT operate the appliance in any greasy environment, such as in the kitchen. This appliance is not intended to filter oil or grease from the air.
- Keep the appliance away from plants and animals.
- DO NOT use the appliance in a room with incense insecticide.
- When using together with non-electric heater, keep the air ventilating. (If the air is not well ventilated, it can generate CO and result in poisoning.)
- DO NOT place anything on top of appliance.

Operating Instructions

PARTS DESCRIPTION

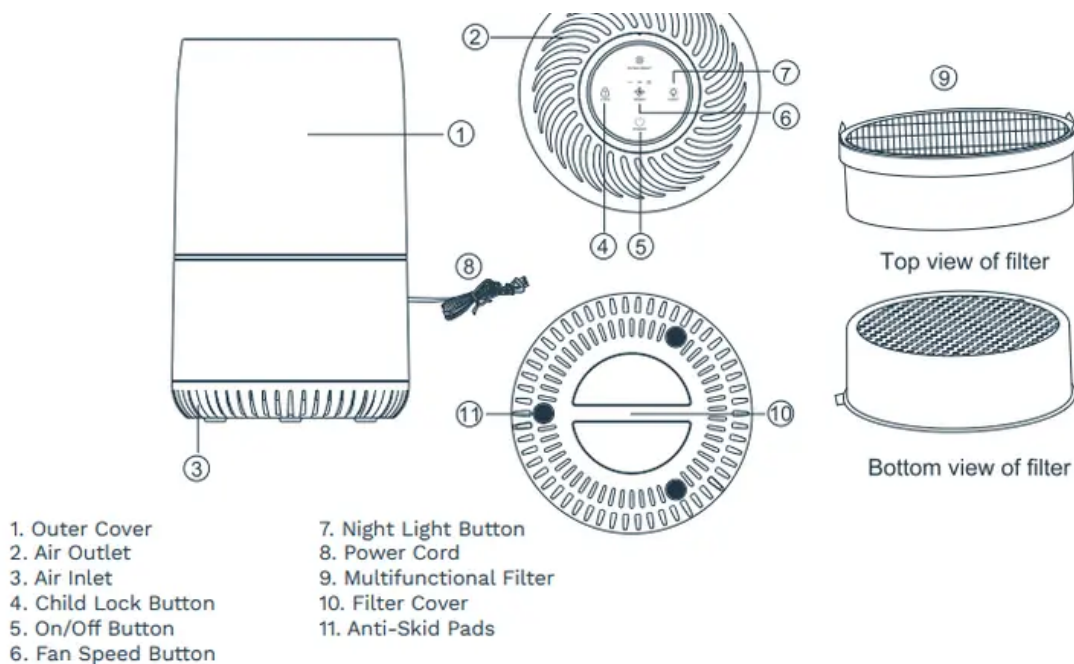

SETTING UP YOUR AIR PURIFIER

Remove the Multifunctional Filter

1. Flip the unit upside down, turn the Filter Cover handle clockwise to the “OPEN” position and remove the cover.

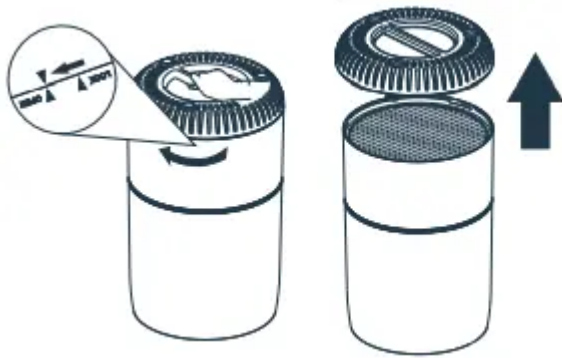

2. Remove the Multifunctional Filter from the purifier.

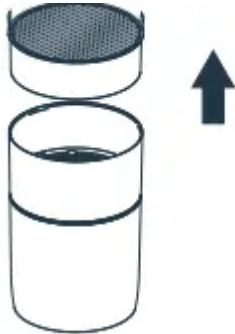

3. Remove the Multifunctional Filter from the plastic bag.

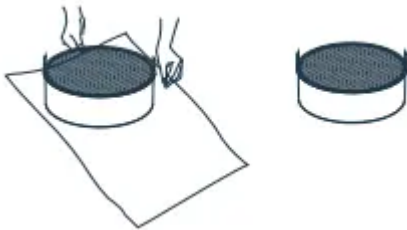

NOTE: The Multifunctional Filter is a consumable. It is not included in the warranty period. Please confirm that the Multifunctional Filter is in good condition before removing from the protective bag.

Multifunctional Filter Installation

1. Install the Multifunctional Filter with the tabs face up and outward.

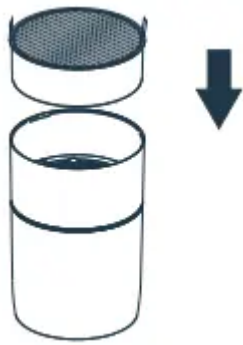

2. Place the Filter Cover on the bottom of the air purifier, aligning the arrows to twist the handle clockwise to the “LOCK” position to secure the filters.

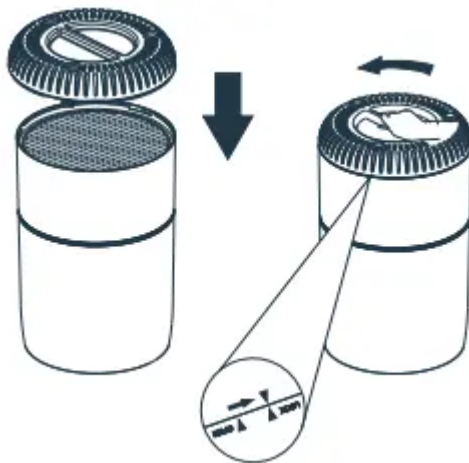

NOTE: DO NOT use the air purifier when the Multifunctional Filter has not be installed.

TIPS:

- For best results, make sure to keep the windows closed while the air purifier is operating.
- Open the windows regularly to maintain proper air circulation throughout your home.
- Always allow 15 inches of clearance on all sides of the purifier.
- Ensure the Multifunctional Filter is properly positioned in the purifier before use.

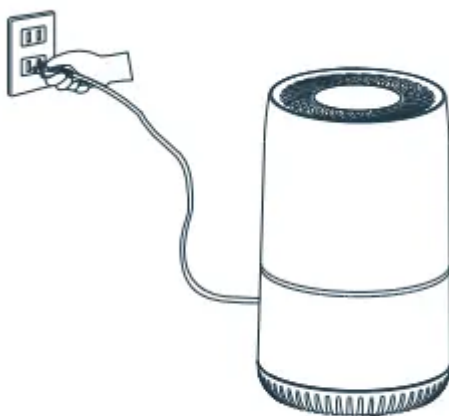

POWER ON

- Before plugging in, make sure that your hands and the plug are dry. Wipe the plug or your hands before plugging into the power socket.
- Place the air purifier on a horizontal surface before plugging it into a power socket.
- Only use the product on a 120V~/60Hz socket.
- After powering on, the light on the operation panel will flash once.

CONTROL PANEL

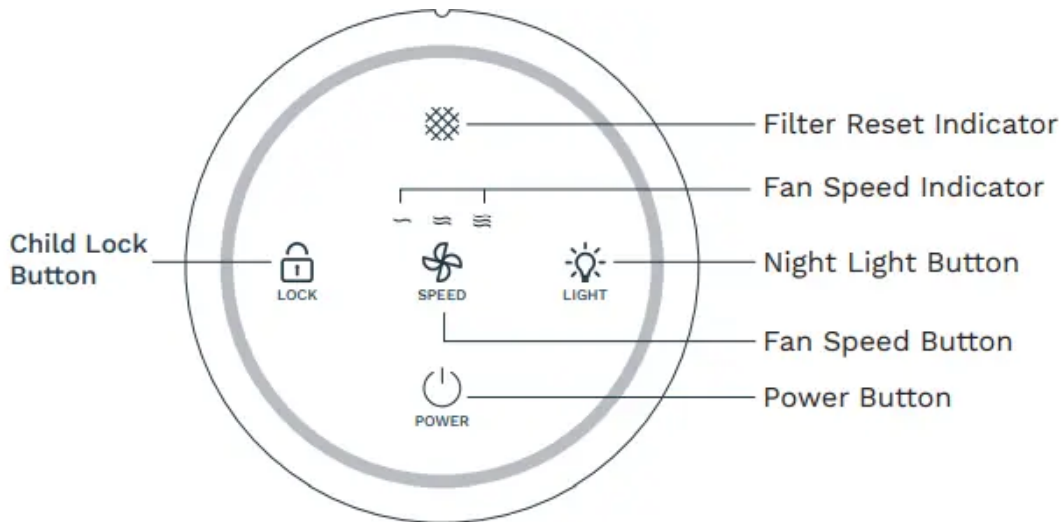

Power Button

- Plug the power plug into the socket and then press the On/Off Button to enter ready mode.
- Under ready mode, the air purifier starts at low speed, the low speed indicator will light up.
- On any working mode except ready mode, press the button and air purifier will stop the present status and enter into ready mode.



Child Lock Button

Press and hold the Lock button for 3 seconds to turn on or off the Lock function. When the unit is locked, the Lock light will be on.



Fan Speed Button

- Press Speed Button, to set wind speed by the order of:
— (low)-- ≈ (medium)-- ≡ (high)-- — (low).
- When the air volume is operating quietly at low speed, corresponding indicator light will be on.
- When the air volume is operating at medium speed, corresponding indicator light will be on.
- When the air volume is operating at high speed, corresponding indicator light will be on.



Night Light Button

Press Light button to turn on or off the light function, or choose brightness.



Resetting the Air Purifier

- The internal timer will calculate the accumulative operating time .
- When the Filter Reset Indicator flashes, replace the filter timely. (The timer is calculated on simulation test in the lab, which may not be accurate in real situation. When the purification effect is getting poor, replace the filter before use.)
- After replacing the filter, turn the appliance on. Press and hold the Light button for 3 seconds. The indicator light will turn out. The filter is now successfully reset



Cleaning and Maintenance

WARNING:

- Always ensure the air purifier is unplugged and cool before cleaning.
 - Multifunctional Filter cannot be washed by water.
1. Turn off the appliance and unplug from the power socket.
 2. To clean the main unit, wipe the air purifier body with dry soft cloth, or soft cloth with a little soap water. Make sure water does not flow into the air purifier, otherwise it may damage your air purifier and lead to electric shock and injury.
 3. Use vacuum cleaner to clean the surface of filter every 4 weeks use to extend the life time of filter. More frequent cleaning will be necessary if the unit is located in an area with a high level of airborne contaminants (excessive amounts of smoke, pet dander, etc.).
 4. We suggest to replace the filter at least 6 months of use or once the Filter Reset Indicator on the top panel flashes.

NOTE:

- Place the air purifier somewhere well ventilated. Never expose to the sun directly. Only turn on the air purifier when it is thoroughly dry.
- Exposing the air purifier to candle/oil/fireplace soot and smoke is not recommended and will require more frequent cleaning.
- Use neutral detergent to clean the air purifier body if needed. DO NOT use cleaning powder, alkaline detergent thinner, bleaching agent, alcohol and gasoline.
- DO NOT operate while changing/removing the Multifunctional filter. It will not be able to remove dust without the filter and the inhaled dust may cause the sensor fault.
- Treat the used Multifunctional Filter as non-combustible rubbish.
- If the operating environment is heavily polluted, shorten the replacement time according to practical situation

Troubleshooting

The Filter Reset Indicator flashes and does not turn off.

- The air purifier has been reset incorrectly. You must replace the filter and press the Night Light Button for 3 seconds. After resetting, the indicator light will turn off.

The air purifier does not respond to button controls.

- The appliance is not connected to the power. Plug into the power socket completely before turning it on.

The air quality has not improved after operating for a long time.

- Make sure to install the filter correctly in proper order. Start from Multifunctional filter to pedestal. DO NOT place in rooms with high humidity level, such as bathroom or toilet. DO NOT place in large rooms. The recommended room size is 194 square foot.

The sound is too loud.

- Before operating, make sure that the packing plastic bag of filter has been removed. (To guarantee the effect of filter, users should unpack plastic bag by themselves.)

The smell is not removed.

- If the appliance is used in the place with strong smell such as smoking area, it will generate odor in several weeks or months. Replace the Multifunctional filter and keep ventilating more frequently

Warranty

hOme™ offers a limited two-year warranty (“warranty period”) on all of our products purchased new and unused from hOme Technologies, LLC or an authorized reseller, with an original proof of purchase and where a defect has arisen, wholly or substantially, as a result of faulty manufacture, parts or workmanship during the warranty period. The warranty does not apply where damage is caused by other factors, including without limitation: (a) normal wear and tear; (b) abuse, mishandling, accident, or failure to follow operating instructions; (c) exposure to liquid or infiltration of foreign particles; (d) servicing or modifications of the product other than by hOme™ ; (e) commercial or non-household use.

The hOme™ warranty covers all costs related to restoring the proven defective product through repair or replacement of any defective part and necessary labor so that it conforms to its original specifications. A replacement product may be provided instead of repairing a defective product. hOme™ 's exclusive obligation under this warranty is limited to such repair or replacement.

A receipt indicating the purchase date is required for any claim, so please keep all receipts in a safe place. We recommend that you register your product on our website, homelabs.com/reg. Although greatly appreciated, the product registration is not required to activate any warranty and product registration does not eliminate the need for the original proof of purchase.

The warranty becomes void if attempts at repair are made by non-authorized third parties and/or if spare parts, other than those provided by hOme™ , are used.

You may also arrange for service after the warranty expires at an additional cost.

These are our general terms for warranty service, but we always urge our customers to reach out to us with any issue, regardless of warranty terms. If you have an issue with a hOme™ product, please contact us at 1-800-898-3002, and we will do our best to resolve it for you.

This warranty gives you specific legal rights, and you may have other legal rights which vary from state to state, country to country or province to province. The customer may assert any such rights at their sole discretion.

Manufacturing Info

This manual is to be used with all items with the model number HME020248N

SKU#: HME020248N

Rated voltage/Frequency: 120V~/60Hz

Rated power: 29W

Contact Us:

- homelabs.com/chat
- 1-(800)-898-3002
- help@homelabs.com

Warning

This content is compiled from multiple sources and is provided for reference purposes only. It may not be complete or fully applicable to all situations. If you are unable to resolve your issue, please contact the product manufacturer or an authorized service provider for official support.

Document generated by [ManualsFile](#)