

INSTALLATION

Parts and Specifications

NOTE: Appearance and specifications may change without notice to improve the quality of the appliance.

Front View

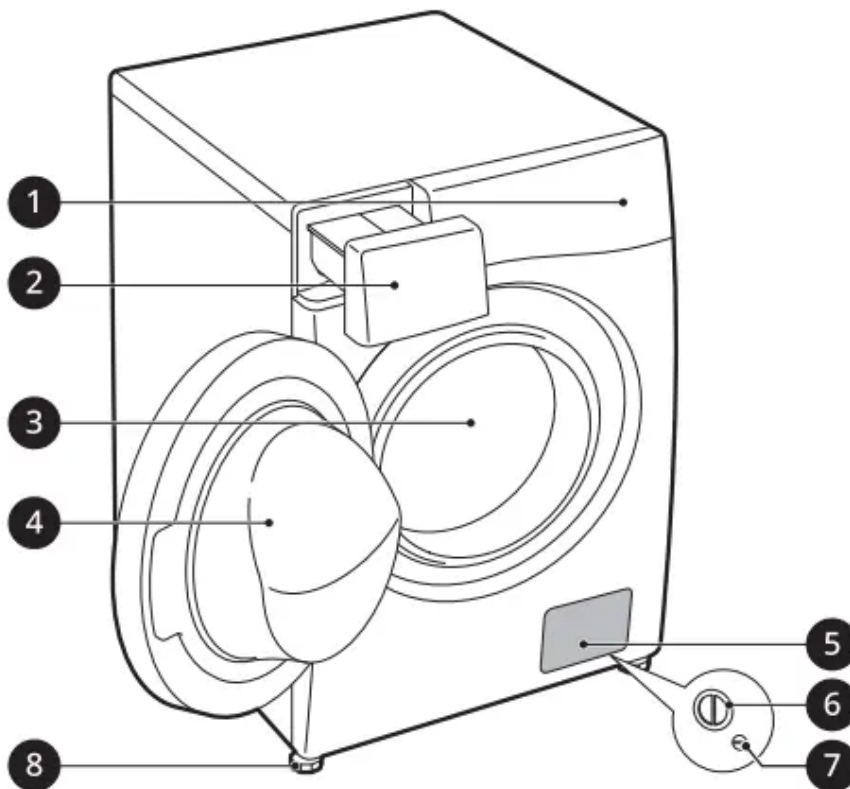

1. Control Panel
2. Detergent Dispenser Drawer
3. Drum
4. Door
5. Cover Cap
6. Drain Pump Filter
7. Drain Plug
8. Levelling Feet

Rear View

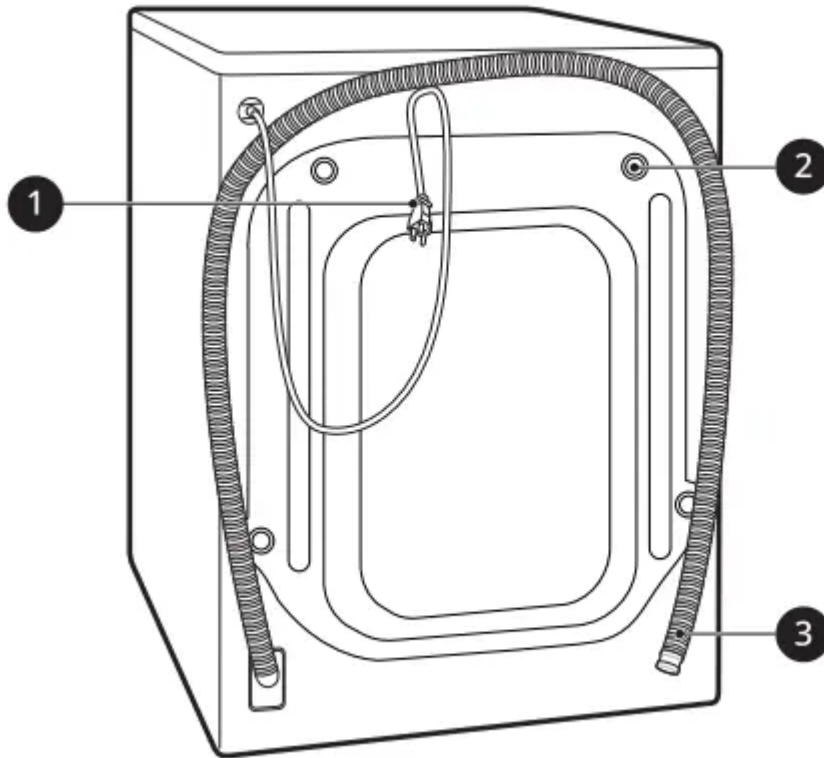

1. Power Plug
2. Transit Bolts
3. Drain Hose

OPERATION

Operation Overview

Using the Appliance Before the first wash, select the Cotton wash programme and add a half amount of the detergent. Start the appliance without clothes. This will remove possible residues and water from the drum that may have been left during manufacturing.

1. Sort clothes and load items.

- Sort clothes by fabric type, soil level, colour and load size as needed. Open the door and load items into the appliance.

CAUTION:

- Before closing the door, ensure that all clothes and items are inside the tub and not overhanging on the rubber door seal where they will become caught when the door is closed. Failing to do so will cause damage to the door seal and the clothes

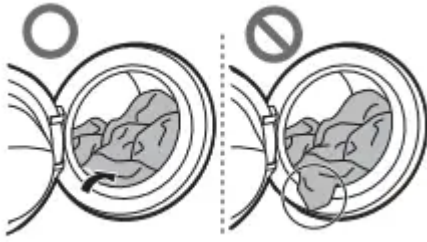

- Remove items from the flexible door seal gasket to prevent clothing and door seal damage.

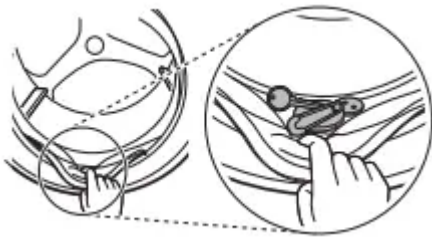

2. Add cleaning products or detergent and softener.

- Add the proper amount of detergent to the detergent dispenser. If desired, add bleach or fabric softener to the appropriate areas of the dispenser.

3. Turn on the appliance.

- Press the Power button to turn on the appliance.

4. Choose the desired cycle.

- Press the cycle button repeatedly or turn the cycle selector knob until the desired cycle is selected.
- Now select a wash temperature and spin speed. Pay attention to the fabric care label of your clothes.

5. Begin cycle.

- Press the Start/Pause button to begin the cycle. The appliance will agitate briefly without water to measure the weight of the load. If the Start/Pause button is not pressed within a certain time, the appliance will shut off and all settings will be lost.

6. End of cycle.

- When the cycle is finished, a melody will sound. Immediately remove your clothing from the appliance to reduce wrinkling. Check around the door seal when removing the load for small items that may be caught in the seal

Preparing the Wash Load

Sort the wash load for best washing results, and then prepare the clothes according to the symbols on their care labels.

Sorting the Clothes

- For best washing results, sort your clothes according to the care label stating fabric type and washing temperature. Adjust the spin speed or spin intensity in accordance to the fabric type.
- Soil level (Heavy, Normal, Light): Separate clothes according to soil level. If possible, do not wash heavily soiled items with lightly soiled ones.
- Colour (White, Lights, Dark): Wash dark or dyed clothes separately from whites or light colours. Mixing dyed clothes with light clothes can result in dye transfer or discolouration of lighter clothes.
- Lint (Lint producers, Collectors): Wash separately lint producing fabrics from lint collecting fabrics. Lint producers can result in pilling and linting on the lint collectors.

Checking the Clothes Care Label

The symbols tell you about the fabric content of your garment and how it should be washed.

Symbols on the Care Labels

Symbol	Wash / Fabric type
	<ul style="list-style-type: none">• Normal Wash• Cotton, Mixed Fabrics
	<ul style="list-style-type: none">• Easy Care• Synthetic, Mixed Fabrics
	<ul style="list-style-type: none">• Special Delicate Wash• Delicates
	<ul style="list-style-type: none">• Hand Wash Only• Wool, Silk
	<ul style="list-style-type: none">• Do not wash

Checking the Clothes before Loading

- Combine large and small items in a load. Load large items first.
- Large items should not be more than half of the total wash load. Do not wash single items. This may cause an unbalanced load. Add one or two similar items.

- Check all pockets to make sure that they are empty. Items such as nails, hair clips, matches, pens, coins and keys can damage both your appliance and clothes.



- Wash delicates (stockings, underwired bras) in a wash net.
- Close zippers, hooks and strings to make sure that these items do not snag on other clothes.
- Pre-treat dirt and stains by brushing a small amount of detergent dissolved water onto stains to help lift dirt.

Adding Detergents and Softeners

Detergent Dosage

- Detergent should be used according to the instruction of the detergent manufacturer and selected according to type, colour, soiling of the fabric and the washing temperature. Use only detergents that are suitable for Drum (front load) type washers.
- If too many suds occur, reduce the detergent amount.
- If too much detergent is used, too many suds can occur and this will result in poor washing results or cause heavy load to the motor.
- If you wish to use liquid detergent, follow the guidelines provided by the detergent manufacturer.
- You can pour liquid detergent directly into the main detergent drawer if you are starting the wash cycle immediately
- Do not use liquid detergent if you are using the Delay End function, or if you have selected Pre Wash option, as the liquid will dispense immediately and may harden in the drawer or the tub.
- Detergent usage may need to be adjusted for water temperature, water hardness, size and soil level of the load. For best results, avoid overdosing the detergent. Failing to do so will cause oversudsing.
- Refer to the label of the clothes, before adding the detergent and choosing the water temperature.
- Use only suitable detergents for the respective type of clothing:
 - Liquid detergent is often designed for special applications, e.g. for coloured fabric, wool, delicate or dark clothes.

- Powdered detergent is suitable for all types of fabric.
- For better washing results of white and pale garments, use powdered detergent with bleach.
- Detergent is flushed from the dispenser at the beginning of the wash cycle.

Using the Dispenser

To add detergent dosage to the dispenser:

1. Open the dispenser drawer.
2. Add the detergent and softener into the appropriate compartments.

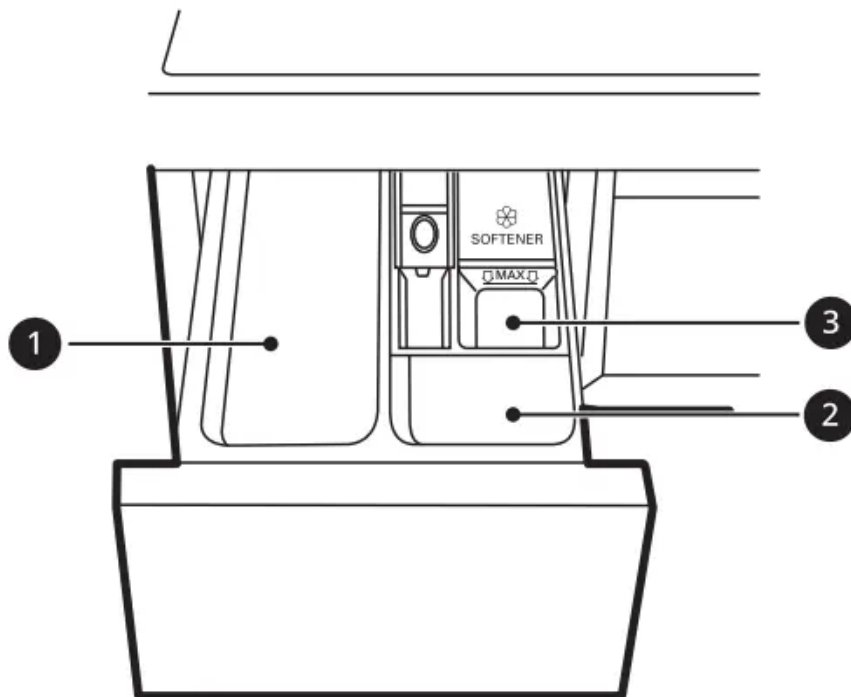

- 1 Main wash detergent compartment**
- 2 Pre-wash detergent compartment**
- 3 Liquid fabric softener compartment**

3. Gently close the detergent dispenser drawer before starting the cycle.
 - Slamming the drawer closed may result in the detergent overflowing into another compartment or dispensing into the drum earlier than programmed.
 - Be careful not to get a hand caught in the drawer while closing.

- It is normal for a small amount of water to remain in the dispenser compartments at the end of the cycle. Fabric Softener Compartment This compartment holds liquid fabric softener, which is automatically dispensed during the final rinse cycle.

Fabric Softener Compartment

This compartment holds liquid fabric softener, which is automatically dispensed during the final rinse cycle. Either powdered or liquid fabric softener may be used.

- Pour fabric softer to the maximum fill line. Pouring excessive fabric softener over the maximum fill line can cause it to dispense too early, which may stain the clothes.

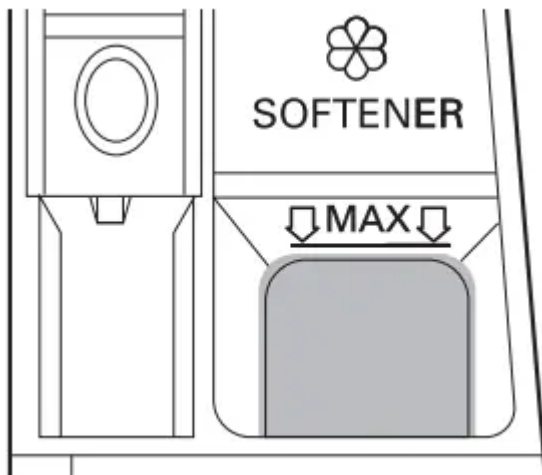

Adding Detergent Tablets

Detergent tablets can also be used when washing.

1. Open the door and put detergent tablets into the drum before loading the clothes.
2. Load the clothes into the drum and close the door.

Adding Water Softener

A water softener, such as anti-limescale can be used to cut down on the use of detergent in areas with high water hardness level.

- First add detergent, and then the water softener. Dispense according to the amount specified on the packaging

Control Panel

The actual control panel may differ from model to model.



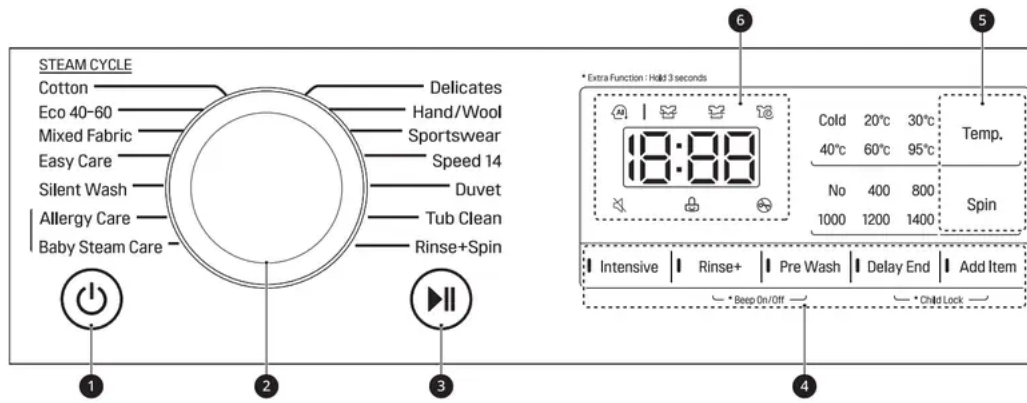

Control Panel Features

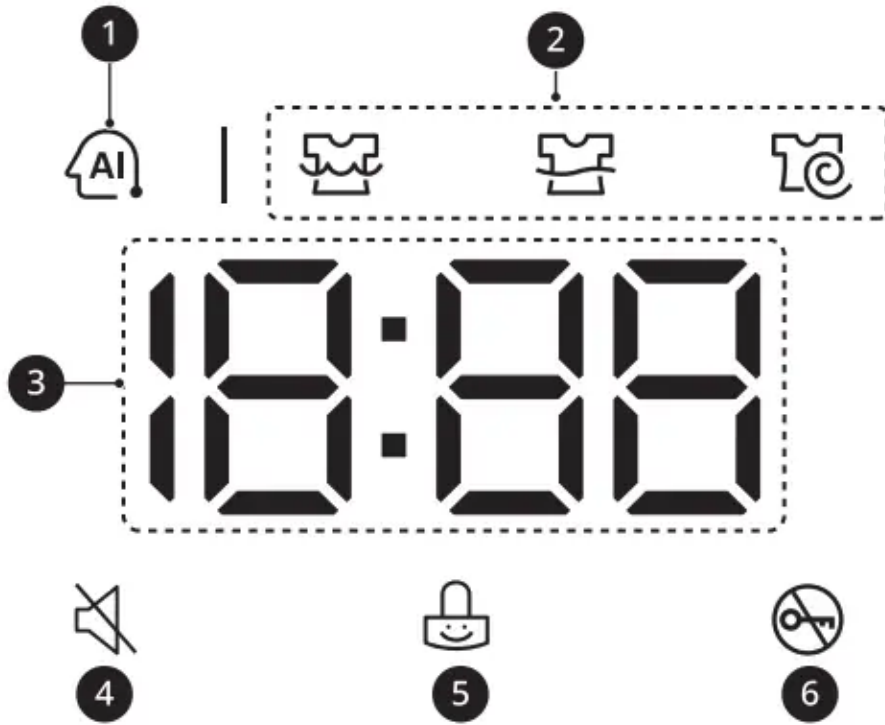

	Description
1	<p>Power On/Off Button</p> <ul style="list-style-type: none"> • Press this button to turn the washing machine on.
2	<p>Programme Knob</p> <ul style="list-style-type: none"> • Programmes are available according to the clothes type. • The lamp will light up to indicate the selected programme.
3	<p>Start/Pause Button</p> <ul style="list-style-type: none"> • This button is used to start the wash cycle or pause the wash cycle. • If a temporary stop of the wash cycle is needed, press this button.
4	<p>Extra Options and Functions</p> <ul style="list-style-type: none"> • To use the extra functions, press and hold the corresponding button for 3 seconds. The corresponding symbol lights up in the display. • This allows you to select an additional programmes and will light when selected.
5	<p>Customizing Washing Programme Buttons</p> <p>Use these buttons to adjust the water temperature or spin speed settings for the selected programme.</p> <ul style="list-style-type: none"> • The current settings are shown in the display. • Press the button for that option to select other settings.
6	<p>Display</p> <ul style="list-style-type: none"> • The display shows the settings, estimated remaining time, options, and status messages. When the appliance is turned on, the default settings in the display will illuminate. • While the load weight is sensed automatically, the display on the control panel blinks.

Time and Status Display



	Description
1	<p>AI DD</p> <ul style="list-style-type: none"> • AI DD  provides the appropriate drum rotation actions after load sensing is completed. •  is activated when the Cotton, Mixed Fabric, and Easy Care programmes are selected and operated.
2	<p>Programme Status Indicators</p> <ul style="list-style-type: none"> • When a washing programme is running, LED for the active stage will blink, and the LEDs for the remaining stages will remain steady. Once a stage is complete, the LED will turn off. If a cycle is paused, the active stage LED will stop blinking.
3	<p>Estimated Time Remaining</p> <ul style="list-style-type: none"> • When a washing programme is selected, the default time for that programme is displayed. This time will change as options are selected. • If the display shows --- , then the time will be displayed after the load sensing has detected the load size. This is normal. • The time shown is only an estimate. This time is based on normal operating conditions. Several external factors (load weight, room temperature, incoming water temperature, etc.) can affect the actual time.
4	<p> lights up when the beep sound is turned off.</p>
5	<p> lights up when the control panel is locked except for the Power button.</p>
6	<p> lights up when the programme starts and the door is locked.</p>

Extra Options and Functions

You can use the extra options and functions to customize the programmes.

Customising a Washing Programme

Each programme has default settings that are selected automatically. You may also customise these settings using these buttons.

Temp.

This button selects the wash temperature for the selected programme.

- Press the Temp. button until the desired setting is lit.
- Select the water temperature suitable for the type of load you are washing. Follow the garment fabric care labels for best results.

Spin

The spin intensity level can be selected by pressing this button repeatedly.

- Press the Spin button to select spin speed.

Rinse+

This function is recommended for people with detergent allergies.

- Press the Rinse+ button for adding rinse once.

Intensive

This function is used to wash normal and heavily soiled clothes.

- Press the Intensive button.

Follow the next steps to customise a washing programme:

1. Prepare the clothes and load the drum.
2. Press the Power button.
3. Add detergent.
4. Select a washing programme.
5. Customise the washing programme (Temp., Spin, Rinse+ and Intensive) as necessary.
6. Press the Start/Pause button.

Only Using a Spin Function

1. Prepare the clothes and load the drum.
2. Press the Power button.
 - Do not select a washing programme and do not add a detergent.
3. Press the Spin button.
4. Press the Start/Pause button

Using Basic Options

You can customize the programmes by using the following basic options:

Pre Wash

This option is recommended when washing a heavily soiled load.

1. Press the Power button.

2. Select a washing programme.
3. Press the Pre Wash button as necessary.
4. Press the Start/Pause button.

Add Item

You can use this option in order to add or remove clothes after the washing programme has started.

1. Press the Power button.
2. Select a washing programme.
3. Press the Start/Pause button.
4. Press the Add Item button as necessary.
5. Open the door after it unlocks itself and add or remove necessary clothing items.
6. Close the door and press the Start/ Pause button.

Delay End

You can set this function so that the appliance starts automatically and finishes after a specified time interval.

1. Press the Power button.
2. Select a washing programme.
3. Press the Delay End button as necessary.
4. Press the Start/Pause button.

Settings

Child Lock

Use this option to disable the controls. This function can prevent children from changing cycles or operating the appliance.

Locking the Control Panel

1. Turn on the power.
2. Press and hold the Delay End and Add Item buttons at the same time for 3 seconds to activate this function.
 - A beeper will sound, and CL will appear on the display.

Unlocking the Control Panel

1. Turn on the power.
2. Press and hold the Delay End and Add Item buttons at the same time for 3 seconds to deactivate this function.

Beep On/Off

This appliance plays a melody when it starts and stops.

- Press and hold the Rinse+ and Pre Wash buttons simultaneously for 3 seconds to deactivate/activate this function.

SMART FUNCTIONS

LG ThinQ Application

The LG ThinQ application allows you to communicate with the appliance using a smartphone.

LG ThinQ Application Feature



Communicate with the appliance from a smartphone using the convenient smart features.

- Smart Diagnosis: This function provides useful information for diagnosing and solving issues with the appliance based on the pattern of use.

Installing the LG ThinQ Application



- Search for the LG ThinQ application from the Google Play Store or Apple App Store on a smartphone. Follow instructions to download and install the application.

Smart Diagnosis

This feature is only available on models with the  or  logo. Use this feature to help you diagnose and solve problems with your appliance

Using Audible Diagnosis to Diagnose Issues

Follow the instructions below to use the audible diagnosis method.

- Launch the LG ThinQ application and select the Smart Diagnosis feature in the menu. Follow the instructions for audible diagnosis provided in the LG ThinQ application.
1. Press the Power button to turn on the appliance.
 - Do not press any other buttons.
 2. Place the mouthpiece of your smartphone close to the  or  logo.

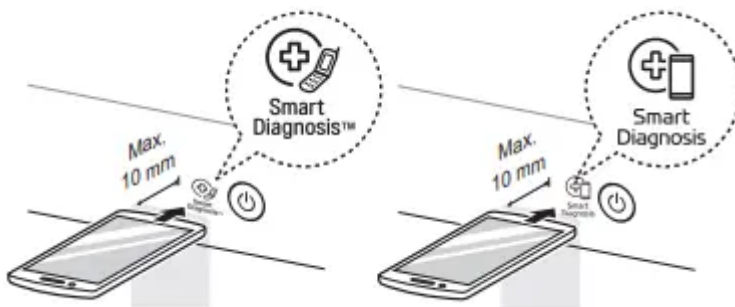

3. Press and hold the Temp. button for 3 seconds or longer while holding the smartphone mouthpiece to the logo until the data transfer is complete.

- Keep the smartphone in place until the data transfer has finished. Time remaining for data transfer is displayed.

4. After the data transfer is complete, the diagnosis will be displayed in the application.

MAINTENANCE

WARNING

- Unplug the appliance before cleaning to avoid the risk of electric shock. Failure to follow this warning may result in serious injury, fire, electric shock, or death.
- Never use harsh chemicals, abrasive cleaners, or solvents to clean the appliance. They may damage the finish.

Cleaning After Every Wash

What to Clean

Always remove items from the washing machine as soon as the cycle is complete. Leaving damp items in the washing machine can cause wrinkling, colour transfer, and odour.

- After the wash cycle is finished, wipe the door and door seal to remove any moisture.
- Leave the door slightly open to dry the drum.
- Wipe the appliance with a dry cloth to remove any moisture.

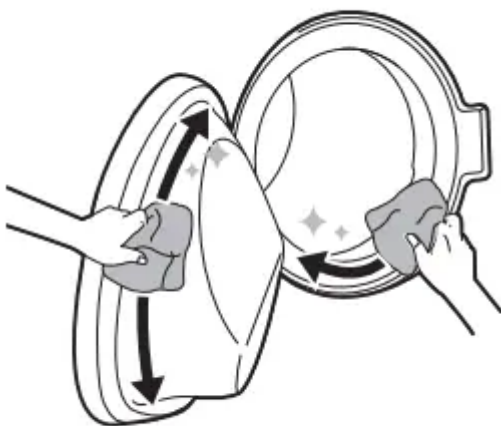

WARNING: Leave the door open to dry inside of the appliance only if the children are supervised at home.

Cleaning the Exterior

Proper care of your appliance can extend the service life.

Exterior

- Immediately wipe off any spills.
- Wipe with a damp cloth and then again with a dry cloth ensuring there is no moisture in cabinet joints or crevices.
- Do not press on the surface or the display with sharp objects.

Door

- Wash with a damp cloth on the outside and inside and then dry with a soft cloth.

WARNING: Do not attempt to separate any panels or disassemble the appliance. Do not apply any sharp objects to the control panel in order to operate the appliance.

Cleaning the Appliance Periodically & Performing an Emergency Water Evacuation

Tub Clean

This is a special function to help clean the inside of the appliance by soaking, washing, rinsing and spinning.

Run this function once a month (or more often if needed) to reduce build-up of detergent and softener and other residue.

- If there is a bad smell or mildew inside the appliance, run this function once a week for 3 weeks in addition to the regularly prompted intervals.

NOTE: The **tCL** message will be displayed to alert to the recommendation of operating this function.

1. Remove any clothing or items from the appliance and close the door.
2. Open the dispenser drawer and add anti limescale powder to the main wash compartment.
 - Tablets can be placed directly into the drum as an alternative to powder.
3. Close the dispenser drawer slowly.
4. Turn on the power, and then select the Tub Clean.
5. Press the Start/Pause button to start.
6. Leave the door open to dry the inside of the appliance completely.
 - When the inside of the appliance is not dried completely, it may cause a bad smell or mildew.

WARNING: Leave the door open to dry inside of the appliance only if the children are supervised at home.

Cleaning the Water Inlet Filter

The water inlet filter collects lime or any sediment that may be in water that is supplied to the appliance. If the water is very hard or contains traces of limescale, the filter on the water inlet may clog regularly.

- Turn off the water supply taps to the appliance if the appliance is to be left for a certain period of time (e.g. holiday), especially if there is no floor drain (gully) in the immediate vicinity.
- **E** error message will be displayed on the control panel when the water is not entering the detergent drawer.

1. Turn off the power and the water tap and then unscrew the water inlet hose.



2. Remove the water inlet filter with small pliers and then clean the filter using a medium bristle tooth brush.

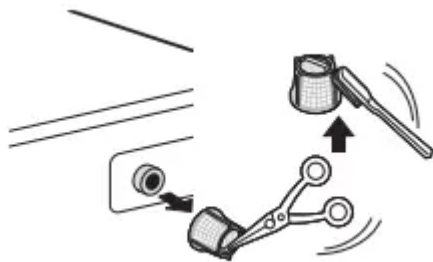

Cleaning the Drain Pump Filter and Performing an Emergency Water Evacuation

The drain filter collects threads and small objects that may have been accidentally left in the clothes. Check regularly that the filter is clean to ensure smooth running of your appliance.

Allow the water to cool before cleaning the drain pump filter. Open the door in an emergency or perform an emergency water evacuation.

1. Unplug the appliance.
2. Open the cover cap and pull out the drain tube.

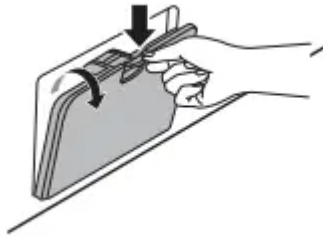

3. Remove the drain plug from the drain tube first 1, and then drain the water. Then slowly unscrew the drain pump filter 2 to drain the remaining water and then proceed to remove any debris or objects from the filter.

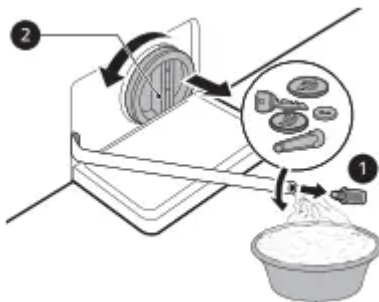

4. After cleaning the drain pump filter, carefully reinsert the filter and screw the drain cap back in clockwise carefully to avoid cross threading and leakage. Reinsert the plug back into the drain tube and place the tube into its holder.

5. Close the cover cap.

CAUTION

- Be careful when draining, as the water may be hot.
- Run the drum cleaning programme once a month (or more often, as needed) to remove excess detergent and other debris.

Cleaning the Dispenser Drawer

Detergent and fabric softener can build up in the dispenser drawer. Liquid detergents can remain under the dispenser drawer and not dispense completely. Remove the drawer and inserts and check for build-up of cleaning products once or twice a month.

1. Remove the detergent dispenser drawer by pulling the drawer straight out until the drawer stops.

- Then gently pull the drawer outward while pressing hard the disengage button.

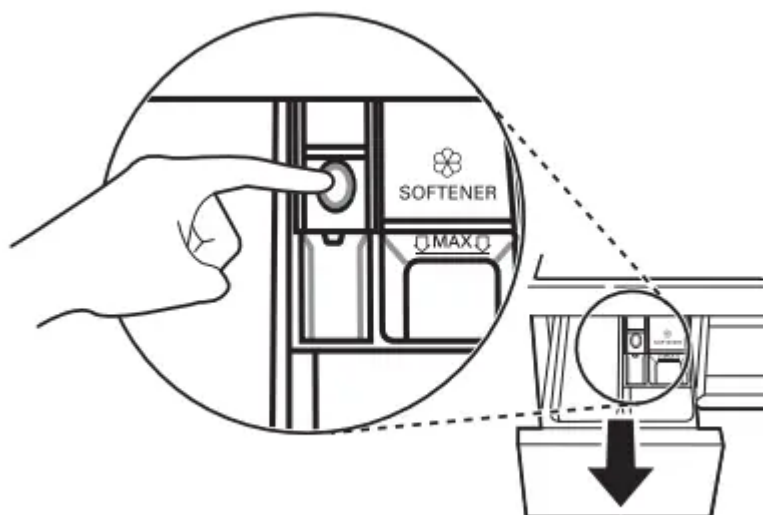

2. Remove the build-up of detergent and softener.

- Rinse the drawer and the components of the drawer with warm water to remove the build-up from detergent and softener. Use only water to clean the dispenser drawer. Dry the drawer and the components of the drawer with a soft cloth or towel.

3. To clean the drawer opening, use a cloth or small, non-metal brush to clean the recess.

- Remove all residue from the upper and lower parts of the recess.

4. Wipe any moisture off the recess with a soft cloth or towel.

5. Reassemble the components of the drawer to the proper compartments and insert the drawer.

TROUBLESHOOTING

Operation of your appliance can lead to errors and malfunctions. The following tables contain possible causes and notes for resolving an error message or malfunction. It is recommended to read the tables carefully below in order to save your time and money that may cost for calling to LG Electronics service centre.

Before Calling for Service

Your appliance is equipped with an automatic error-monitoring system to detect and diagnose problems at an early stage. If the appliance does not function properly or does not function at all, check the following tables before calling to LG Electronics service centre

Error Messages

Symptoms	Possible Cause & Solution
IE INLET ERROR	<p>Water supply is not adequate in that location. Water does not enter appliance or it enters slowly.</p> <ul style="list-style-type: none"> • Check another tap in the house.
	<p>Water supply tap is not completely open. Water does not enter the appliance or it enters slowly.</p> <ul style="list-style-type: none"> • Open fully tap.
	<p>Water supply hose(s) are kinked.</p> <ul style="list-style-type: none"> • Straighten hose or reinstall the water inlet hose
	<p>The filter of the supply hose(s) are clogged.</p> <ul style="list-style-type: none"> • Check and clean the inlet valve filter after turning off the taps and removing the hose connections to the washing machine.
UE UNBALANCE ERROR	<p>The appliance has a system which detects and corrects the unbalance of the appliance.</p> <ul style="list-style-type: none"> • The clothes may be too wet at the end of the cycle, rearrange the load to allow proper spinning. Close the door and press Start/Pause button. It may take a few moments before the appliance begins to spin. The door must be locked before spin can be achieved.
	<p>Load is too small. This system may stop spinning or even interrupt the spin cycle altogether if individual heavy articles (e.g. bath mat, bath robe, etc.) are loaded.</p> <ul style="list-style-type: none"> • Add 1 or 2 similar items or smaller articles of clothes to help balance the load. Close the door and press Start/Pause button. It may take a few moments before the appliance begins to spin. The door must be locked before spin can be achieved.
OE WATER OUTLET ERROR	<p>Drain hose is kinked or clogged. Water in the appliance does not drain or drains slowly.</p> <ul style="list-style-type: none"> • Clean and straighten the drain hose.

	<p>The drain filter is clogged.</p> <ul style="list-style-type: none"> • Check and clean the drain filter.
<p>dE dE1 dE2 dE4 DOOR ERROR</p>	<p>Door sensor malfunctions.</p> <ul style="list-style-type: none"> • Please call LG service centre. You can find your local LG service centre phone number in the warranty card.
<p>tE CONTROL ERROR</p>	<p>This is a control error.</p> <ul style="list-style-type: none"> • Unplug the power plug and call for service.
<p>LE MOTOR LOCKED ERROR</p>	<p>Over load in motor.</p> <ul style="list-style-type: none"> • Let the appliance wait for 30 minutes until the motor is cooled down and then, restart the cycle.
<p>FE OVERFLOW ERROR</p>	<p>Water overfills due to a possible faulty water valve.</p> <ul style="list-style-type: none"> • Close the water tap. Unplug the power plug. Call for service.
<p>PE PRESSURE SENSOR ERROR</p>	<p>Water level sensor malfunctions.</p> <ul style="list-style-type: none"> • Close the water tap. Unplug the power plug. Call for service.
<p>uS VIBRATION SENSOR ERROR</p>	<p>Vibration sensor malfunctions.</p> <ul style="list-style-type: none"> • Call for service.
<p>FF FROZEN FAILURE</p>	<p>Is supply/drain hose or drain pump frozen?</p> <ul style="list-style-type: none"> • Supply warm water into the drum in order to unfreeze the drain hose and the drain pump. Cover the supply hose with wet and warm towel.
<p>AE WATER LEAKAGE</p>	<p>Water leaks.</p> <ul style="list-style-type: none"> • Call for service.
<p>PF POWER FAILURE</p>	<p>The appliance experienced a mains power failure.</p> <ul style="list-style-type: none"> • Restart the cycle.

Noises You Might Hear

Symptoms	Possible Cause & Solution
Rattling and clanking noise	<p>Foreign objects, such as keys, coins, or safety pins may be in the drum.</p> <ul style="list-style-type: none"> • Stop the appliance, check the drum for foreign objects. If the noise continues after the appliance is restarted, call for service.
Thumping sound	<p>Heavy clothes may produce a thumping sound. This is usually normal.</p> <ul style="list-style-type: none"> • If the sound continues, the appliance is probably out of balance. Stop and redistribute the clothes.
	<p>The clothes may be out of balance.</p> <ul style="list-style-type: none"> • Pause the programme and redistribute the clothes after the door unlocks.
Vibrating noise	<p>Package materials are not removed.</p> <ul style="list-style-type: none"> • Remove package materials.
	<p>The clothes may be unevenly distributed in the drum.</p> <ul style="list-style-type: none"> • Pause the programme and redistribute the clothes after the door unlocks.
	<p>Not all levelling feet are resting firmly and evenly on the floor.</p> <ul style="list-style-type: none"> • See the Levelling the Appliance instruction to adjust the levelling of the appliance.
	<p>Floor not rigid enough.</p> <ul style="list-style-type: none"> • Check if the floor is solid and does not flex. See the Installation Place Requirements to select the proper location.

Operation

Symptoms	Possible Cause & Solution
Water is leaking.	House drain pipes are clogged. <ul style="list-style-type: none"> • Unclog waste pipes. Contact plumber if necessary.
	Leakage is caused by improper installation of drain hose or clogged drain hose. <ul style="list-style-type: none"> • Clean and straighten the drain hose. Check and clean the drain filter regularly.
	Drain pump filter cap is not fitted correctly. <ul style="list-style-type: none"> • Refit the drain pump filter.
Symptoms	Possible Cause & Solution
Appliance does not operate.	Control panel has powered off due to inactivity. <ul style="list-style-type: none"> • This is normal. Press the Power button to turn the appliance on.
	Appliance is unplugged. <ul style="list-style-type: none"> • Make sure that the cord is plugged securely into a working outlet.
	Water supply is turned off. <ul style="list-style-type: none"> • Turn the water supply tap completely.
	Controls are not set properly. <ul style="list-style-type: none"> • Make sure that the programme is correctly set. Close the door and press the Start/Pause button.
	Door is open. <ul style="list-style-type: none"> • Close the door and make sure that nothing is caught under the door preventing it from closing completely.
	Circuit breaker/fuse is tripped/blown. <ul style="list-style-type: none"> • Check house circuit breakers/fuses. Replace fuses or reset breaker. The appliance should be on a dedicated branch circuit. The appliance will resume the programme where it stopped once power is restored.

	<p>Control needs to be reset.</p> <ul style="list-style-type: none"> • Press the Power button, then reselect the desired programme and press the Start/Pause button.
	<p>Start/Pause was not pressed after a programme was set.</p> <ul style="list-style-type: none"> • Press the Power button, then reselect the desired programme and press the Start/Pause button. The appliance is turned off if the Start/Pause button is not pressed within a certain time.
	<p>Extremely low water pressure.</p> <ul style="list-style-type: none"> • Check another tap in the house to make sure that household water pressure is adequate.
	<p>Appliance is heating the water or making steam.</p> <ul style="list-style-type: none"> • The drum may stop operating temporarily during certain cycles, while water is safely heated to a set temperature.
<p>Buttons may not function properly.</p>	<p>The Child Lock option is activated.</p> <ul style="list-style-type: none"> • Deactivate the Child Lock option if necessary.
<p>Door does not open.</p>	<p>The door cannot be opened for safety reasons once the appliance starts.</p> <ul style="list-style-type: none"> • This is normal. You can safely open the door after H turns off.
<p>Appliance is not filling properly.</p>	<p>Inlet filter clogged.</p> <ul style="list-style-type: none"> • Make sure the inlet filters on the fill valves are not clogged.
	<p>Inlet hoses may be kinked.</p> <ul style="list-style-type: none"> • Check that inlet hoses are not kinked or clogged.
	<p>Insufficient water supply.</p> <ul style="list-style-type: none"> • Make sure that both hot and cold water taps are turned on all the way.
	<p>Hot and cold supply hoses are reversed.</p> <ul style="list-style-type: none"> • Check supply hose connections.

Appliance does not drain water.	Kinked drain hose. <ul style="list-style-type: none"> • Ensure that the drain hose is not kinked.
	Drain located higher than 1.2 m above the floor. <ul style="list-style-type: none"> • Make sure that the drain hose is no higher than 1.2 m above the bottom of the appliance.
Detergent is not dispensed incompletely or not dispensed at all.	Too much detergent is used. <ul style="list-style-type: none"> • Follow the guidelines provided by the detergent manufacturer.
	Drain Pump Filter may be blocked. <ul style="list-style-type: none"> • Clean the Drain filter.
Cycle time is longer than usual.	The load is too small. <ul style="list-style-type: none"> • Add more items to allow the appliance to balance the loads.
	Heavy articles are mixed with lighter items. <ul style="list-style-type: none"> • Always try to wash articles with similar weight in order to allow the appliance to evenly distribute the weight of the load for spinning.
	The load is out of balance. <ul style="list-style-type: none"> • Manually redistribute the load if articles have become tangled.
Symptoms	Possible Cause & Solution
Cycle end is delayed	Unbalance is detected or suds removing programme is on. <ul style="list-style-type: none"> • This is normal. The time remaining shown on the display is only an estimated duration. Actual time may vary.

Performance

Symptoms	Possible Cause & Solution
<p>Poor stain removal</p>	<p>Previously set stains.</p> <ul style="list-style-type: none"> Articles that have been previously washed may have stains which have been set. These stains may be difficult to remove and may require hand washing or pre-treating to aid in stain removal.
<p>Staining</p>	<p>Bleach or softener is dispensed too soon.</p> <ul style="list-style-type: none"> Dispenser compartment is overfilled. It makes bleach or softer dispensed rapidly. Always measure bleach or softener to prevent overfilling. Close the detergent dispenser slowly. <p>Bleach or softener was added directly to the clothes in the drum.</p> <ul style="list-style-type: none"> Always use the detergent dispenser to ensure that bleach or softener is properly dispensed at the right time in the programme. <p>Clothes were not properly sorted.</p> <ul style="list-style-type: none"> Always wash dark colours separately from light colours and whites to prevent discoloration. Never wash heavily soiled items with lightly soiled items.
<p>Wrinkling</p>	<p>Appliance is not unloaded promptly.</p> <ul style="list-style-type: none"> Always remove items from the appliance as soon as the programme is complete. <p>Appliance is overloaded.</p> <ul style="list-style-type: none"> The appliance can be fully loaded, but the drum should not be tightly packed with items. The door of the appliance should be closed easily. <p>Hot and cold water supply hoses are reversed.</p> <ul style="list-style-type: none"> Hot water rinse can set wrinkles in garments. Check the supply hose connections.

	<p>Spin speed may be too high.</p> <ul style="list-style-type: none"> • Set the spin speed to suit the garment type.
--	--

Odour

Symptoms	Possible Cause & Solution
Musty or mildewy odour in appliance	<p>Inside of drum is not cleaned properly.</p> <ul style="list-style-type: none"> • Run the Tub Clean function regularly.
	<p>The drain hose is not properly installed, causing siphoning (water flowing back inside of the appliance).</p> <ul style="list-style-type: none"> • When installing the drain hose, make sure that it does not get kinked or blocked.
	<p>The detergent dispenser is not cleaned regularly.</p> <ul style="list-style-type: none"> • Remove and clean the detergent dispenser, especially the top and the bottom of the dispenser's opening.
	<p>Odours can occur if the drain hose is not properly installed, causing siphoning (water flowing back inside of the appliance).</p> <ul style="list-style-type: none"> • When installing the drain hose, make sure that it does not get kinked or blocked.
	<p>If the detergent dispenser is not cleaned regularly, odours can occur from mold or foreign substances.</p> <ul style="list-style-type: none"> • Remove and clean the detergent dispenser, especially the top and bottom of the dispenser's opening.

Warning

This content is compiled from multiple sources and is provided for reference purposes only. It may not be complete or fully applicable to all situations. If you are unable to resolve your issue, please contact the product manufacturer or an authorized service provider for official support.

