

HOW A DEHUMIDIFIER WORKS

When the dehumidifier is switched ON, a fan pulls moisture-laden air into the dehumidifier where it passes through dehumidifying coils inside the unit. These coils condense moisture from the air and collect it in the water tank. The dry air is then exhausted from the dehumidifier. The air flows through the air vents of the dehumidifier into the room as dry, warm air.

IMPORTANT: The dehumidifier is designed to operate between 41°F (5°C) and 89°F (32°C). The dehumidifier's performance may be greatly reduced if room temperature is beyond this temperature range.

SELECTING A LOCATION - IMPORTANT

- Before using the dehumidifier, place the unit UPRIGHT for at least 1 hour before use to allow the refrigerant to stabilize. If the unit was tilted on its side or upside-down during transportation, set the unit upright for 4 hours before use.
- For optimal efficiency, the dehumidifier must be operated in an enclosed area. Keep all doors, windows and other outside entrances to the room closed.



- Place the dehumidifier in an area where the temperature will not drop below 41°F (5°C)
- Place the dehumidifier at least 17.7 inches (45 cm) away from other objects (e.g. curtains or furniture) that may restrict airflow from the back or through the air vents of the unit.
- The dehumidifier must be positioned on a level floor.

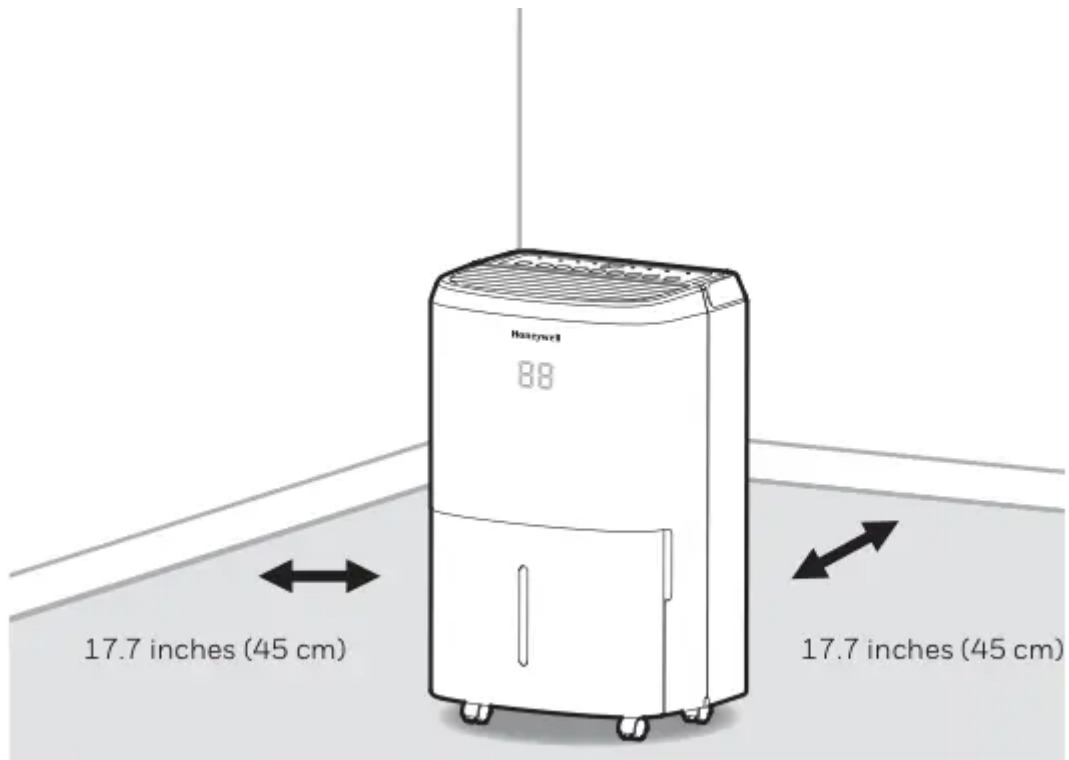

IMPORTANT: The effectiveness of the dehumidifier can be influenced by different factors. One factor is the rate at which new, moisture-laden air enters the room and the amount of air circulating in and out of the area to be dehumidified. For example, if a door to a basement is constantly opened, letting new, moisture-laden air into the room, dehumidification will take longer than if the door was kept closed. If the dehumidifier is in a room with a storage closet or cabinets, it will have little or no effect in drying the inside of the storage closet or cabinets unless there is adequate circulation of air in and out of these spaces. To dehumidify these spaces, open the storage door or cabinet doors to allow air circulation. You may find that installing a second dehumidifier may be required for larger enclosed areas.

UNPACKAGING THE DEHUMIDIFIER

- This Dehumidifier is packaged with a colored or transparent tape to secure some parts during transportation. Remove the colored or transparent packaging tape from the unit.
1. Gently pull the water tank from out of the dehumidifier
 2. Remove the splash guard from the top part of the water tank
 3. Take out the power plug, drain hose and other accessories, which is placed inside the tank of the dehumidifier.
 4. Once all accessories have been removed, replace the splash guard onto the top part of the water tank. Make sure that the tank is properly positioned.

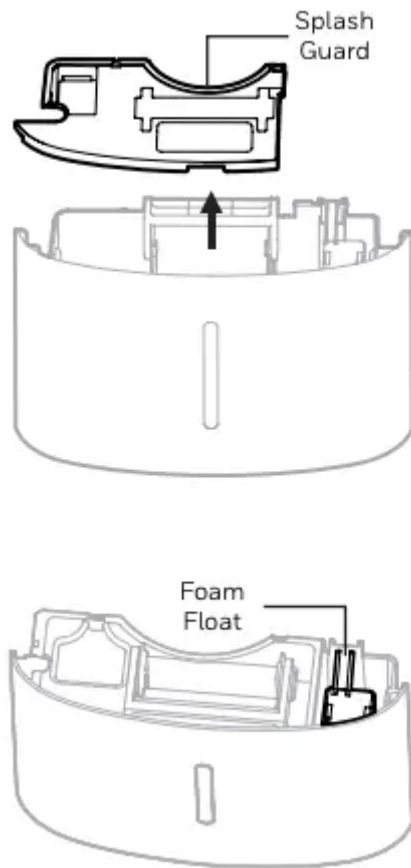

- There is a Foam Float inside the water tank that senses the water level to automatically stop dehumidification when the water tank is full. Make sure the Foam Float is positioned correctly inside the water tank by ensuring it lies level with the top edge of the water tank.

DO NOT REMOVE THIS FOAM FLOAT.

PARTS DESCRIPTION

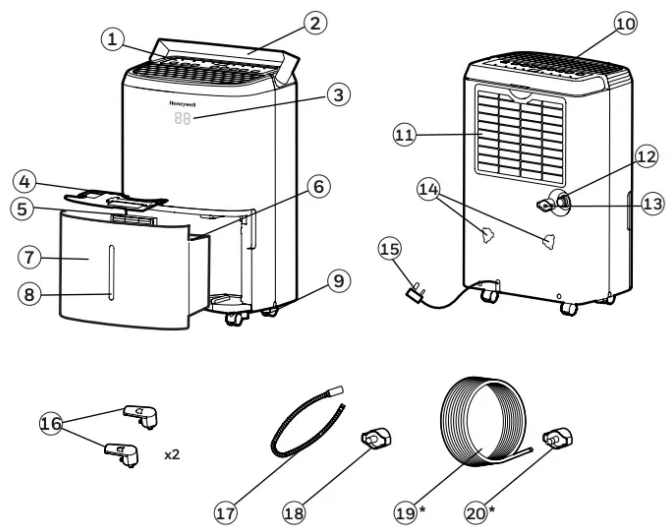

Control Panel

1)

- 2) *Handle*
- 3) *LED Display*
- 4) *Splash Guard*
- 5) *Water Tank Handle*
- 6) *Foam Float*
- 7) *Water Tank*
- 8) *Water Level Indicator*
- 9) *Casters*
- 10) *Dehumidified Air Exhaust Vent*
- 11) *Washable Dust Filter*
- 12) *Direct Drain Outlet*
- 13) *Direct Drain Cap*
- 14) *Mounting Holes for Cord Winders*
- 15) *Power Cord & Plug*
- 16) *Cord Winders*
- 17) *Continuous Water Drain Tube*
- 18) *Continuous Water Drain Cap*

*** THIS IS ONLY FOR MODEL TP70P WITH BUILT-IN DRAIN PUMP**

- 19) *Auto Drain Pump Tube*
- 20) *Auto Drain Pump Cap*

INSTALL THE CORD WINDER

Once you have removed the cord winder accessories from the water tank - follow the steps below.

Step 1: Line up the cord winder pieces to the mounting holes.

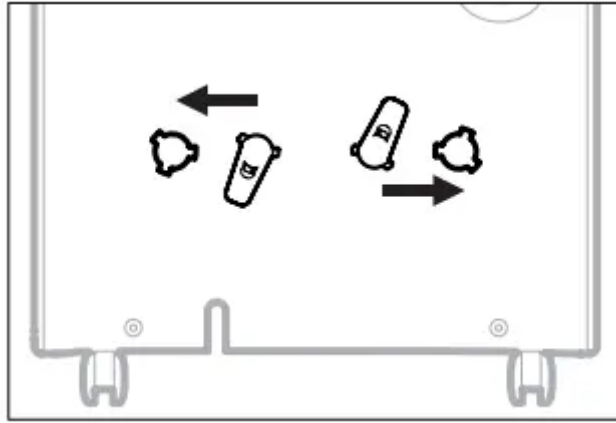

Step 2: Rotate 45-degrees clock-wise.

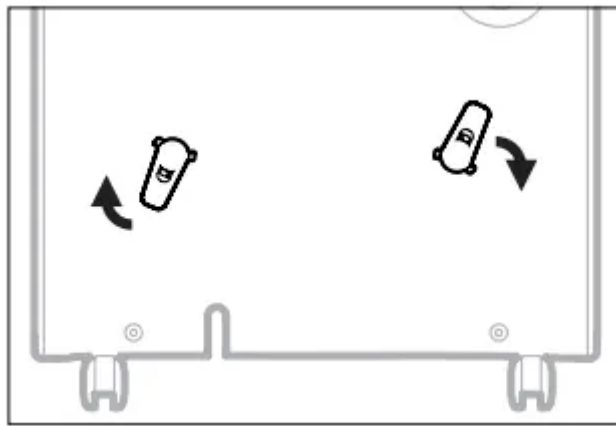

Step 3: Once you hear “click”, then you know the cord winder is ready for use

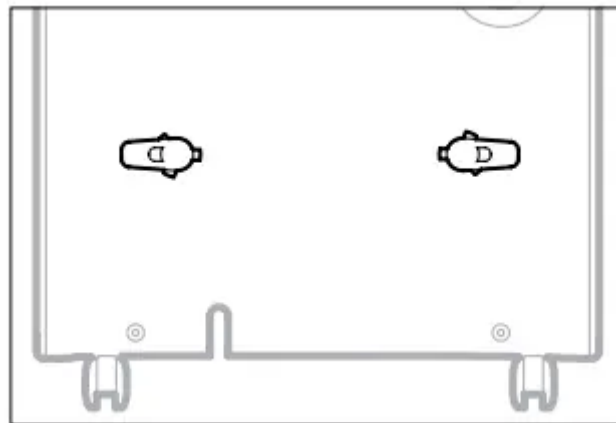

NOTE: Once the installation of the cord winder has been completed. The cord winder cannot be removed. The installation is permanent.

USE & OPERATION

CONTROL PANEL

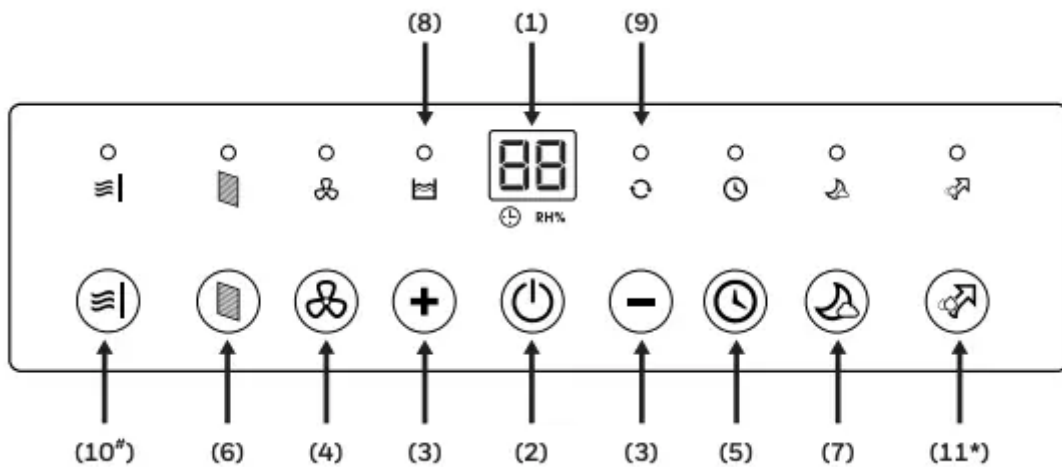

1) Display Screen

2) Power Control

3) Humidity / Timer Set Controls

4) Fan Speed Control

5) Timer Control

6) Filter Alert

7) Sleep Mode

8) Water Full Indicator Light

9) Continuous Operation Light

THIS IS ONLY FOR MODEL TP50H WITH PTC TECHNOLOGY

10) PTC Mode

*THIS IS ONLY FOR MODEL TP70P WITH BUILT-IN DRAIN PUMP

11) Auto Drain Pump Mode

FUNCTION BUTTONS

POWER CONTROL 

Press  to switch the dehumidifier ON or OFF.

HUMIDITY CONTROL SETTING





When the unit is switched ON, the Display Screen shows the current humidity percentage. Press **+** or **-** to select your preferred humidity level. The humidity is adjusted in increments of 5% by pressing **+** or **-**. The adjustable Relative Humidity (RH) range is between 30% RH to 90% RH. Ten seconds after setting the preferred humidity setting, the display will revert back to displaying the current humidity.

Recommended Settings: It is recommended to leave the unit running at 30% humidity at High Fan Speed during the first 2 to 3 days until damp odors are removed. After a few days when the Relative Humidity has been reduced to a more comfortable level, press **+** or **-** to choose a higher RH% that maintains a comfortable humidity level thereafter. A recommended healthy humidity level is between 40% and 50%.

NOTE: The humidity sensor senses current humidity in the surrounding area. It is normal for a few degrees of variance to the humidity sensitivity from the sensor.

CONTINUOUS MODE

To activate the Continuous Mode, press the **-** button on the Display Screen until  appears. The  indicator light will be illuminated. The unit will run continuously.

WATER TANK FULL ALERT

When the Water Tank is full, the  indicator will be illuminated. The unit will beep for 3 seconds.

The compressor will shut off, and the fan will stop for a few minutes. To switch off the  indicator light, empty the water tank and when replacing it ensure the tank is secured properly in place.





IMPORTANT: Do not place the Water Tank on the floor when full. In case of an uneven base which may cause the tank to spillover.

TIMER CONTROL



The dehumidifier can be set to automatically switch ON or OFF for a selected period of time (between 0.5-24 hour intervals). The Timer hours selection is displayed on the Display Screen.

NOTE: Before setting the Timer control, make sure there is power to the unit.

Auto-Off Timer:

While the unit is running, press , the timer  indicator light will flash, press  or  to select the number of hours (0.5-24 hours) you want the unit to run before it switches off. In 5 seconds without the operation, the Timer start function, the timer  indicator light is illuminated. Timer must be set again after each use.



Auto-On Timer:

When unit is in Standby Mode, press , the timer  indicator light will flash, press **+** or **-** to select the number of hours (0.5-24 hours) until you want the unit to automatically start running. In 5 seconds without the operation, the Timer start function, the timer  indicator light is illuminated. The previous fan speed and humidity setting will be maintained. The unit will turn on and continue running until the water tank is full (unless the unit is set up for continuous draining) or until you switch it off manually. Timer must be set again after each use.

NOTE: To cancel any Timer settings, simply press  again, and the timer  indicator light will disappear.

NOTE: The solid red Power light indicates the unit is on Standby Mode.

FAN SPEED CONTROL



There are two fan speeds - High and Low. When, the  indicator light is illuminated, the unit is operating on High speed. When the  indicator light is off, and the unit is on - the unit is operating on Low speed.

FILTER ALERT

When the Filter Alert Light is ON, it is time to clean the filter. Switch the unit OFF and carefully remove the filter from the unit and clean. Replace the filter and switch ON the unit.



The Filter Alert Light should not be illuminated until the filter requires cleaning again. The frequency of filter cleaning depends on room environment conditions. Some rooms may require changing more frequently than others.

SLEEP MODE

The LED display brightness will be reduced when the unit is in Sleep Mode. Press the  to activate the Sleep Mode. When Sleep Mode is activated the  indicator light will be illuminated. There is a one-minute window period in which you can adjust the settings such as humidity and fan



speed. After one minute has lapsed, the top display will shut off, except the  indicator light. Press any button to deactivate Sleep Mode.

PTC HEATER MODE#

Press the  to activate PTC Heater Mode, the  indicator light is illuminated. The PTC Heater function is suitable for environments with a temperature of 0°F to 41°F (0°C to 5°C). This technology helps to add heat to the dehumidifying process which helps to improve the efficiency, and increases the dehumidifying capacity of the unit.

THIS IS ONLY FOR MODEL TP50H WITH PTC TECHNOLOGY

AUTO DRAIN PUMP MODE*

The Auto Drain Pump function helps to remove condensation vertically and horizontally. Press the  to activate the Pump function, the  indicator light will be illuminated.

THIS IS ONLY FOR MODEL TP70P WITH BUILT-IN DRAIN PUMP

AUTO RESTART FUNCTION

This unit is equipped with an Auto Restart feature. When there is a power outage, the dehumidifier will automatically resume all its previous settings upon regaining power.

AUTOMATIC DEFROST

Frost may build up on the internal coils of the unit. When there is frost build up, the internal compressor will turn off and the fan will continue to run until the frost has melted. Once the internal coils have defrosted and dried, the compressor or fan will automatically restart and dehumidifying will resume.

DRAINING THE WATER

WARNING: Always drain and discard water collected from dehumidification. The water is not clean and cannot be used for drinking.

1. Draining water collected in the Water Tank

The condensed water can be collected directly into the water tank. When the water tank is full, the dehumidifier will automatically shut OFF and the  indicator will illuminate on the control panel followed by a beeping sound.

IMPORTANT: Do not move the dehumidifier when the Water Tank is full as it will be heavy and can cause water spillage.

1. Locate the water tank at the front of the dehumidifier. Gently pull the water tank out.
2. Grip the handle inside the water tank and carry the water tank to a sink to empty.
3. Replace the empty water tank back into the front of the dehumidifier. Please make sure that the tank is properly positioned. The safety feature ensures that any misalignment of the tank and the unit will prevent the unit from turning back on.

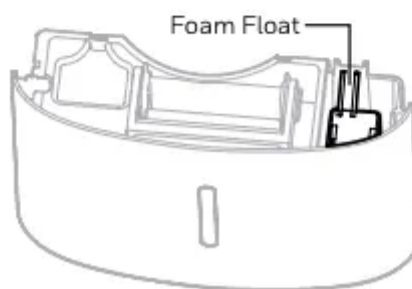
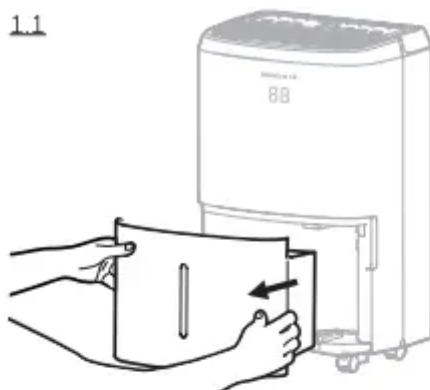

IMPORTANT: Improper alignment or positioning of the water tank will cause the unit to pause operation, the warning light on top of the dehumidifier will illuminate followed by a beeping sound, until the water tank is fitted properly.

NOTE: There is a Foam Float inside the water tank that senses the water level to automatically stop dehumidification when the water tank is full. Make sure the Foam Float is positioned correctly inside the water tank by ensuring it lies level with the top edge of the water tank.

DO NOT REMOVE THIS FOAM FLOAT.

2. Continuous Water Drainage – Using a Continuous Water Drain Tube

A continuous water drainage tube is included with this unit. To activate the continuous water draining function, you will require a suitable water drain (e.g. sink or drain hole at floor level) near the dehumidifier.

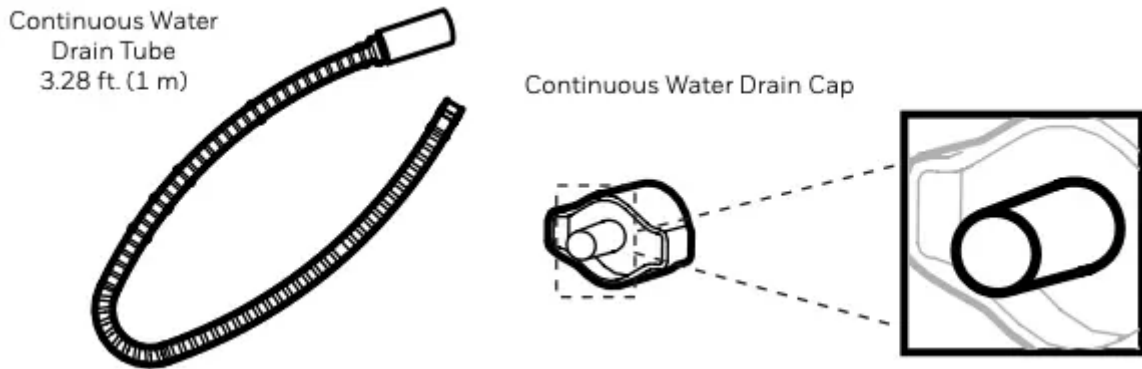

NOTE: The Continuous Drain Tube and Continuous Drain Cap come pre-installed.

1. Locate the drain outlet at the back of the unit. Unscrew and remove the Direct Drain Cap. Insert and screw the Continuous Water Drain Tube into the Direct Drain Outlet.

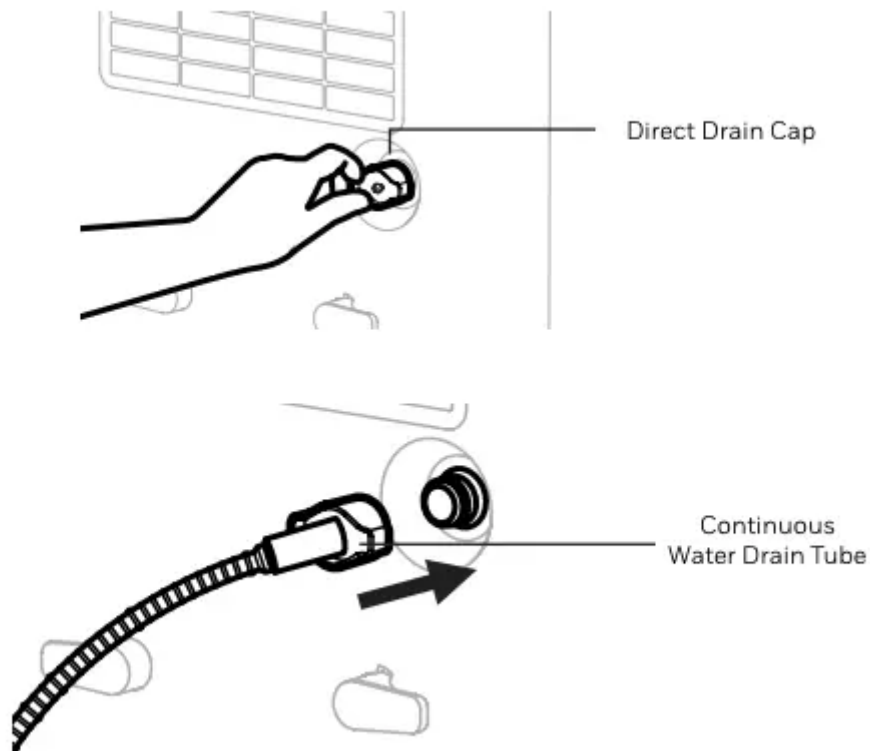

2. If there are leaks, the Continuous Water Drain Tube and Cap may have loosened and may not be connected properly. Disconnect, replace and tighten again.

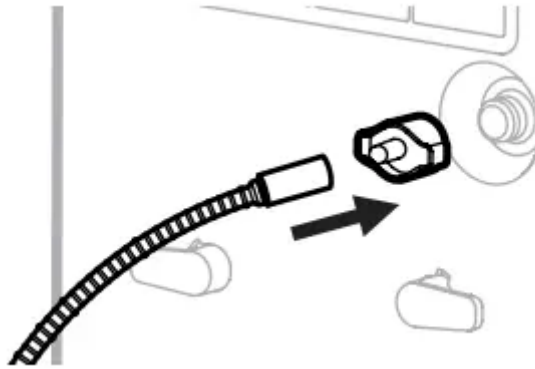

3. Position the other end of the Continuous Water Drain Tube in the sink or drain. Make sure the tube is not bent or kinked which might stop the water flow. Make sure the tube is secured over the drain and will not fall out of place causing unwanted water spillage.

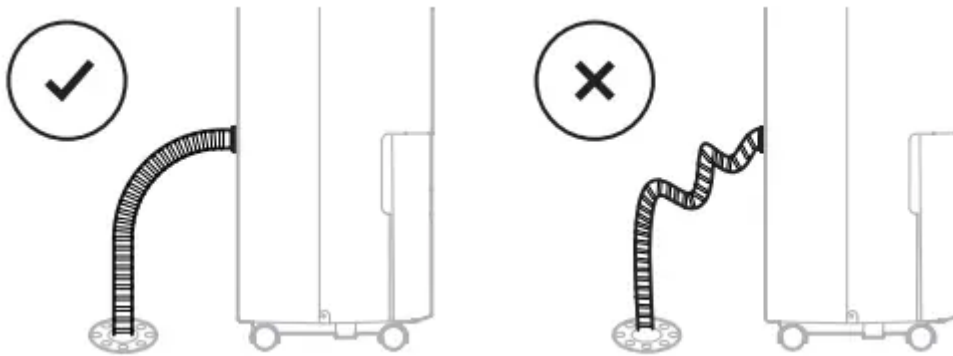

IMPORTANT: Make sure water can flow down the Continuous Water Drain Tube by keeping the tube angled down and free of bends or kinks.

IMPORTANT: If the unit is placed on uneven ground, or the Drain Tube is installed incorrectly, the water may fill the water tank and stop running. Please check whether the ground is uneven and reinstall the Drain Tube.

*THIS IS ONLY FOR MODEL TP70P WITH BUILT-IN DRAIN PUMP

3. Continuous Water Drainage – Using the Auto Drain Pump option

The Auto Drain Pump is available if you want to use the continuous drain function, but the drain is further away, or located above the dehumidifier. The Auto Drain Pump Tube can be attached to the Direct Drain Outlet located on the back side of the dehumidifier. When the water level in the water tank reaches a certain level, the drain pump will automatically pump the water out of the tank to the drain. This allows you to drain water condensation vertically or horizontally, even if the drain is located above the dehumidifier

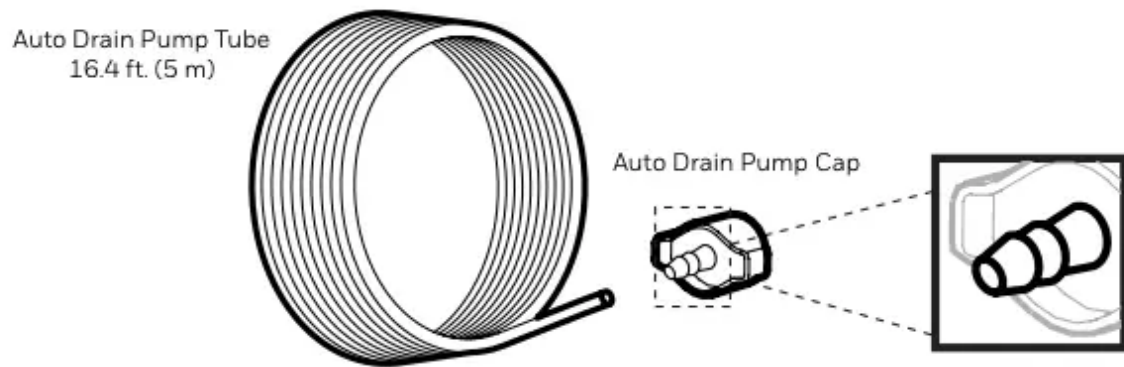

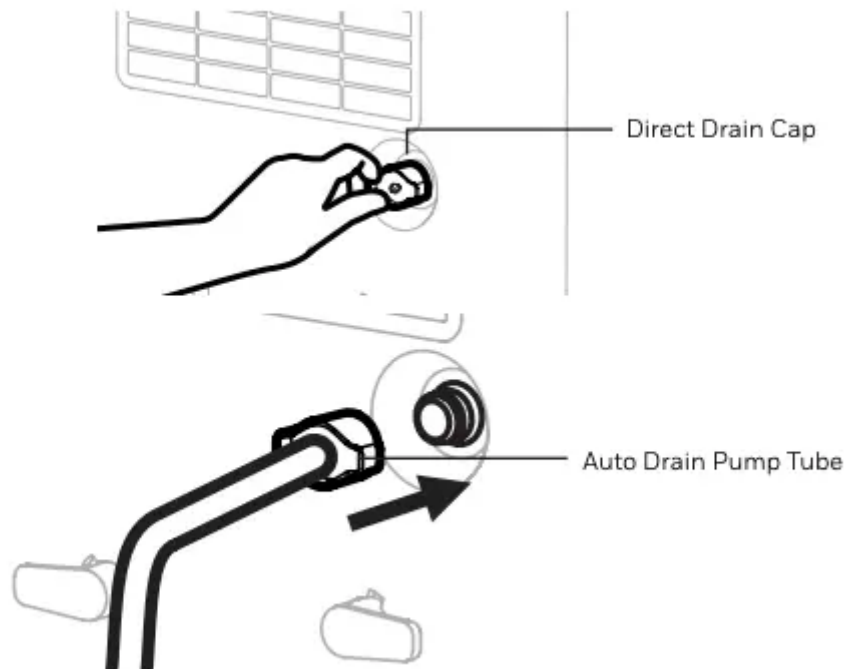

NOTE: The Auto Drain Pump Tube and Auto Drain Pump Cap come pre-installed

1. Locate the drain outlet at the back of the unit. Unscrew and remove the Direct Drain Cap. Insert and screw the Auto Drain Pump Tube into the Direct Drain Outlet.

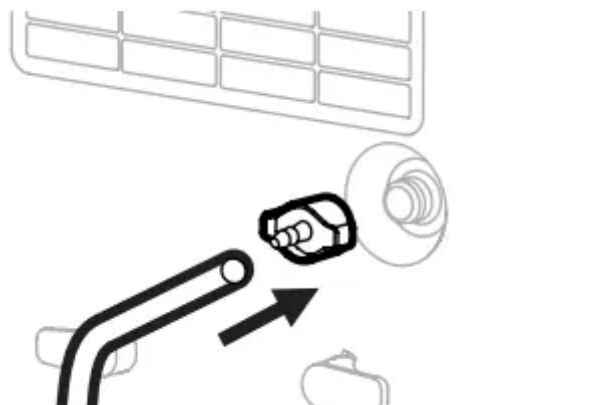

2. If there are leaks, the Auto Drain Pump Tube and Auto Drain Pump Cap may have loosened and may not be connected properly. Disconnect, replace and tighten again.



3. To activate the Pump function, press the  indicator. Once on, the  indicator light will be illuminated.

4. Place the other end of the tube into the sink or drain. The water can be pumped up to 16.4 ft (5 m) vertically or horizontally.

NOTE: DO NOT use an alternative drain tube that is longer than the one provided with the unit.

CLEANING & MAINTENANCE

WARNING: Always switch OFF the dehumidifier and unplug it from the electrical outlet before attempting any cleaning or maintenance of this product.

Appliance Maintenance:

- Switch OFF the appliance before disconnecting the power supply.
- Only use a soft cloth to clean the appliance.

Dust Filter Maintenance:

The Dust Filter located at the back of the unit helps to remove dust particles from the air. A dirty filter clogged by dust particles can reduce the efficiency of the dehumidifier. For optimum dehumidification, it is recommended to clean the dust filter every 2 weeks:

1. Switch off and unplug the dehumidifier from the electrical outlet.
2. Carefully pull out the dust filter from the dehumidifier.
3. Rinse the dust filter under running water, or vacuum away the dust with a vacuum cleaner.
4. After cleaning the dust filter, dry in a cool, shaded place, then carefully reinstall into the unit.



End of Season Storage & Maintenance:

If the appliance will not be used for an extended period of time:

- Switch OFF the unit and unplug from the electrical power outlet.
- Empty the water tank and let it dry. If your dehumidifier is connected to the continuous drain hose, you must disconnect the hose, dry and then replace the drain cap back into the drain outlet.
- Remove the air filter and clean with water. Let the air filter dry and reinstall back into the unit.
- Make sure all parts of the dehumidifier and accessories are dry before storage.
- Cover the dehumidifier with a cloth/ plastic bag before storage, to protect the surface from dust and scratches.
- It is recommended to coil the power cord and store it off the floor to ensure it is protected from bends and kinks.
- Store the unit upright in a dry location, away from direct sunlight.

TROUBLESHOOTING GUIDE

The following troubleshooting guide addresses the most common problems. If problems persist, call customer service.

PROBLEM	POSSIBLE CAUSE	SOLUTION
Dehumidifier does not start	No electricity.	Check for power.
	The power cord is not properly plugged in.	Remove and reconnect the power cord.
	The safety switch activated on the electrical plug.	Reset the safety switch and wait for 3 minutes to pass. Contact customer service if problem persists.
	The water tank is not in the correct position.	Position the water tank correctly into the unit. Unit will not operate until the water tank is secure in place.
Unit runs but the humidity level does not decrease	The humidity level setting is too high.	Decrease the humidity level setting.
	A door or window is open, letting in new moisture.	Make sure all windows or doors to the outside are closed and tightly sealed.
	There are other sources of humidity in the room (e.g. boiling water in pot).	Switch on the dehumidifier when these sources are not present.
	The temperature in the room is too low.	The dehumidifier is designed to operate between 41°F (5°C) and 89°F (32°C). Moisture removal is greatly reduced if room temperatures exceed this temperature range.
	The dust filter is dirty/ blocked.	Clean the dust filter.
	Air outlet or intake is blocked.	Remove blockage.
	Insufficient time for the dehumidifier to remove moisture.	After initial installation, allow 24 hours to maintain desired dryness.
Dehumidifier runs constantly/ does not stop	Area to be dehumidified is too large.	The capacity of your dehumidifier may not be adequate for the room it is used in. It is recommended to add an extra dehumidifier for large areas.

	A door or window is open, letting in new moisture.	Make sure all windows or doors to the outside are closed and tightly sealed.
Water Tank Full  is illuminated and the unit is beeping	The water tank is full.	Empty the water tank.
	The water tank is not in the correct position.	Position the water tank correctly into the unit. Unit will not operate until the water tank is secure in place.
The unit is blowing cold air out of the top vent	The purpose of the top air vent is to distribute air into the room.	The temperature of the air from the vent depends on the room environment and other factors. It can fluctuate and this is normal. No action required.
Frost appears on the coils	Dehumidifier has been recently turned on in low room temperatures (usually below 41°F (5°C)).	This is normal. Frost will disappear in an hour or so after the dehumidifier is switched OFF.
Connected the continuous drain but the water condensation is not draining out the tube	Some floors may have an uneven surface which may affect the continuous drainage function	Raise the front of the Dehumidifier ½ to 1 inch (1.27 cm to 2.54 cm) from the floor. The water condensation will drain out the back hose and not into the bucket.
Water on the floor	The garden hose/ drain hose may be loose.	Check the connections between the hose and the drain outlet on the unit. See Continuous Water Drainage section.
	You intended to use the water tank to collect water but the continuous drain hose is still connected.	Disconnect the hose and replace the rubber stopper and drain cap if using the water tank to collect water. See Continuous Water Drainage section.
Noise	Fan is working.	Wind from the fan can create sounds during operation. This is a normal sound.

ERROR CODE GUIDE

CODE	POSSIBLE CAUSE	NOTE
P1	Water tank pull out	This only appears for model TP70P with Built-in Drain Pump. Position the water tank correctly into the unit. Unit will not operate until the water tank is secure in place.
EH	Humidity sensor failure	Please contact the service center
E1 / E2	Temperature sensor failure	Please contact the service center.
E3	Gas leakage	<p>If E3 appears, Please the check the ambient temperature range whether below 89.6°F (32°C).</p> <p>If the ambient temperature over 89.6°F (32°C) place the unit below 86°F (30°C) for 2 hours before running the Dehumidifier again.</p> <p>If the E3 appears again in 2 hours, please contact the service center.</p>

Warning

This content is compiled from multiple sources and is provided for reference purposes only. It may not be complete or fully applicable to all situations. If you are unable to resolve your issue, please contact the product manufacturer or an authorized service provider for official support.