

## Product, parts and accessories

### Instant Pod Multi-pod Single Brew Coffee and Espresso Maker

Make sure everything is installed properly before use.

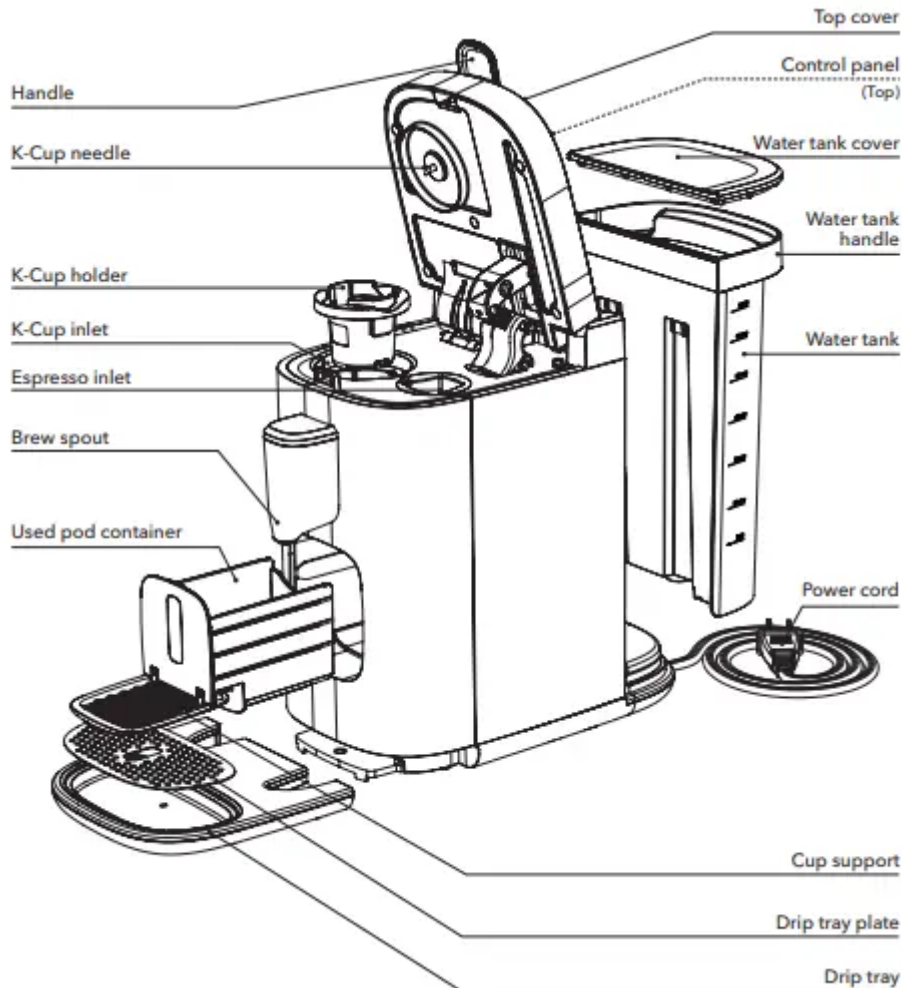

Illustrations in this document are for reference only and may differ from the actual product. Always refer to the actual product.

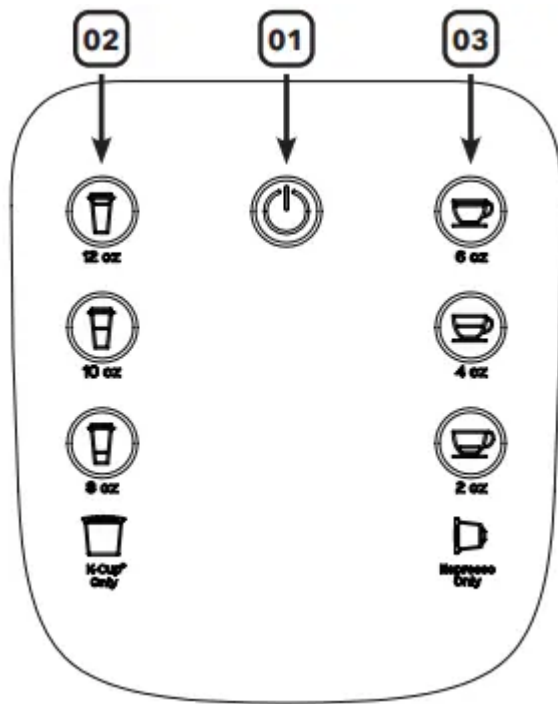

## Control panel

The control panel of your Instant coffee maker is straightforward and super easy to use. If you haven't had your coffee yet, fear not! Your brew is seconds away.



**01**  **Power on/off**

**02 K-Cup pod options**

-  12 oz cup (355 mL)
-  10 oz cup (296 mL)
-  8 oz cup (237 mL)

**03 Espresso pod options**

-  6 oz cup (177 mL)
-  4 oz cup (118 mL)
-  2 oz cup (60 mL)

Illustrations in this document are for reference only and may differ from the actual product. Always refer to the actual product.

## Initial setup

01 Pull your new coffee maker out of the box.

02 Remove all the material, adhesive strips and loose parts from in and around the appliance.

03 Place the coffee maker on a stable, level surface.

04 Lift off the water tank, then remove and discard the red plug. Place the water tank back on the base and press down to secure it.



The sticker on the water tank may be removed.

05 Slide the drip tray into place beneath the front of the coffee maker

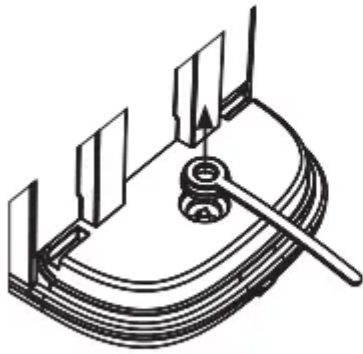

06 Follow the instructions in Initial cleaning before using the coffee maker for the first time.



DO NOT remove safety warning stickers from the appliance.

#### CAUTION

Read the Important Safeguards before using the appliance. Failure to read and follow those instructions for safe use may result in damage to the appliance, property damage or personal injury.

DO NOT place the appliance on a stovetop. Heat from an external source will damage the appliance.

DO NOT block the vents on the bottom of the appliance.

## Initial cleaning

Before making your first piping hot cup, you must clean the coffee maker. To do so, run the following programs without a pod in place.

01 Lift the water tank upwards to remove it from the back of the coffee maker.

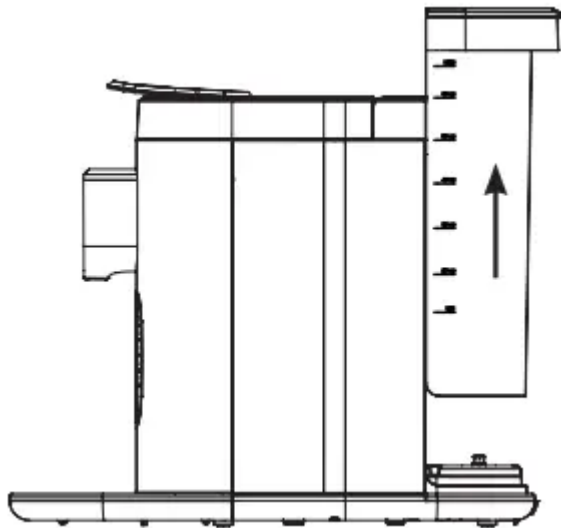

02 Clean the water tank with warm water and dish soap, then rinse it well with clean water.

03 Fill the water tank with cool, clean water to the MAX fill line as indicated on the water tank.

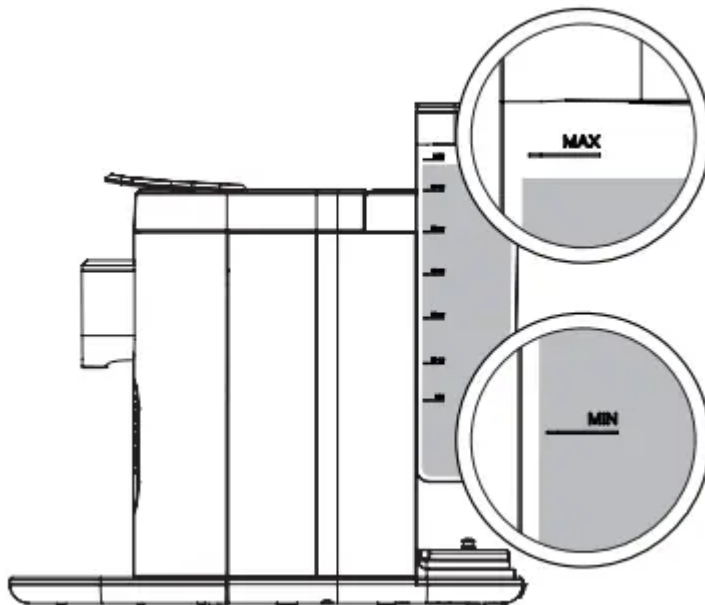

04 Align the water tank with the back of the coffee maker, then press down to secure it.



**Instant Tip** You can leave the water tank on the coffee maker and fill it with a cup or pitcher, or remove it to fill from your faucet or fridge — your choice!

05 Plug the power cord into a 120 V power source.

06 Use the handle to close the top cover.

07 Place a mug beneath the brew spout on the drip tray plate — make sure the mug is large enough to hold 8 oz / 237 mL of water.

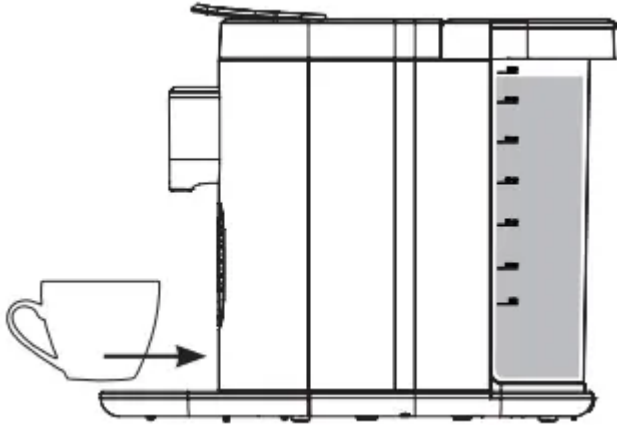

08 Touch the power key. All of the keys illuminate.



09 Touch 6 oz. The key flashes as the water heats.



10 The key illuminates when the coffee maker starts brewing, and soon hot water pours from the brew spout.

To stop brewing at any time, touch 6 oz again.

When the water stops dripping, carefully discard the water in the mug.

11 Place the mug back onto the drip tray plate.

12 Touch 8 oz.

The key flashes as the water heats.



13 The key illuminates when the coffee maker starts brewing, and soon hot water pours from the brew spout.

To stop brewing at any time, touch 8 oz again.

When the water stops dripping, discard the water in the mug. That's it! Brew away, friend.

**CAUTION** Brewed liquid is hot. DO NOT place hands or unprotected skin beneath the brew spout while the coffee maker is brewing.

**WARNING** DO NOT open the top cover while the coffee maker is brewing. Opening the top cover during operation may cause risk of personal injury and/or property damage.

## Brewing K-Cups

Pick your favorite K-Cup, pop it in and in seconds you'll have a hot, steaming cup of delicious brew.

01 Fill the water tank with cool, clean water to between the MIN and MAX fill lines as indicated on the water tank.

02 Use the handle to open the top cover.



It must be fully open to properly receive pods.

03 If it is not already installed, insert the K-Cup holder into the K-Cup inlet.

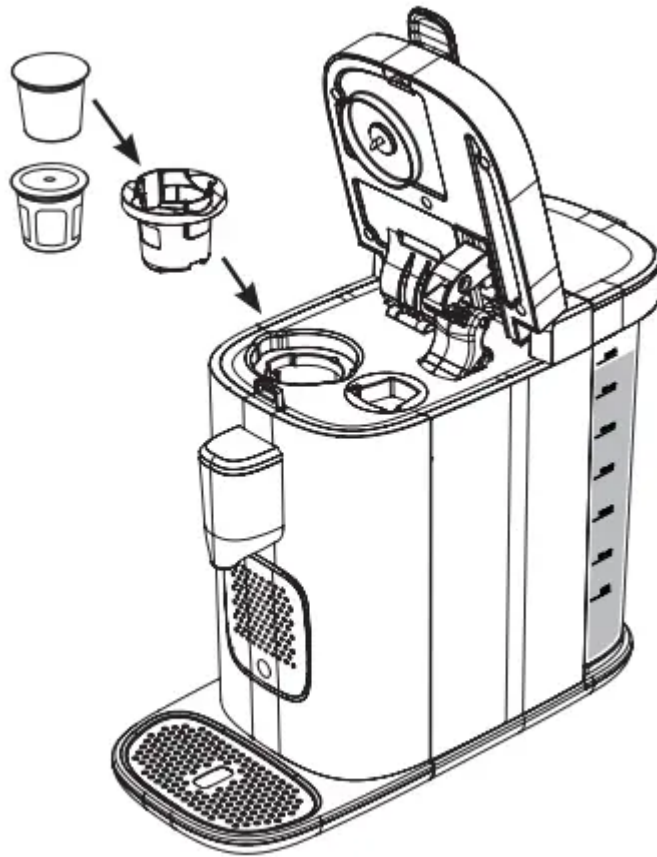

The coffee maker is only compatible with generic, universal reusable K-cups (for use with versions 1.0 AND 2.0).

04 Insert a K-Cup into the K-Cup holder.

05 Press the handle down to close the top cover.

06 Place your mug beneath the brew spout on the drip tray plate, or if necessary, the entire drip tray can be removed to accommodate larger cups.

07 Touch the power key. All of the keys illuminate.

08 Touch 8 oz, 10 oz, or 12 oz from the K-Cup section, depending on how much you want to brew.



12 oz



10 oz



8 oz

The key flashes as the water heats.



Although all cup sizes illuminate, if you select 2 oz, 4 oz, or 6 oz while a K-Cup is in place, the coffee maker will only dispense water.

09 The key illuminates when the coffee maker starts brewing, and soon hot water pours from the brew spout.

To stop brewing at any time, touch the selected cup size key again.

10 When the water stops dripping, lift the handle to open the top cover.

11 Carefully remove the used K-Cup and discard it.

Easy, right? Enjoy!

**NOTICE** DO NOT attempt to brew if the water level is below the MIN fill line as indicated on the water tank.

<b>WARNING</b>		
DO NOT open the top cover while the coffee maker is in operation.	DO NOT touch the blade in the K-Cup holder when the top cover is up.	DO NOT touch the water outlet needle when the top cover is up.



## Brewing espresso pods

There's a world of flavor packed into those itty-bitty espresso pods just waiting to be brewed out. The coffee maker is compatible with the original Nespresso-style capsules.

**NOTICE** Before brewing your first cup from an espresso pod, follow the steps in the Initial cleaning to heat a cup of water without a pod in place.

01 Fill the water tank with cool, clean water to between the MIN and MAX fill lines as indicated on the water tank.

02 Use the handle to open the top cover.

 It must be fully open to properly receive pods.

03 Insert the espresso pod on its side into the Espresso inlet.

 Do not push down hard on the pod as it will go through to the used pod container.

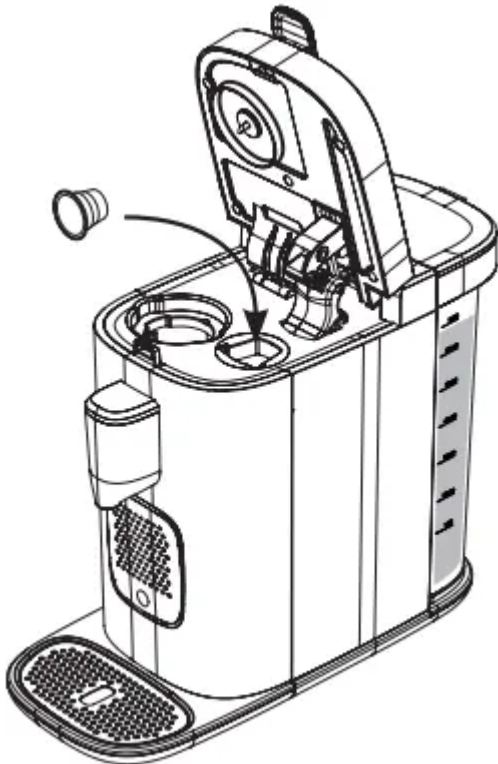

04 Press the handle down to close the top cover.

05 To brew 2 oz or 4 oz, fold down the cup support and place your mug on it.

To make 6 oz, place your cup onto the drip tray plate.

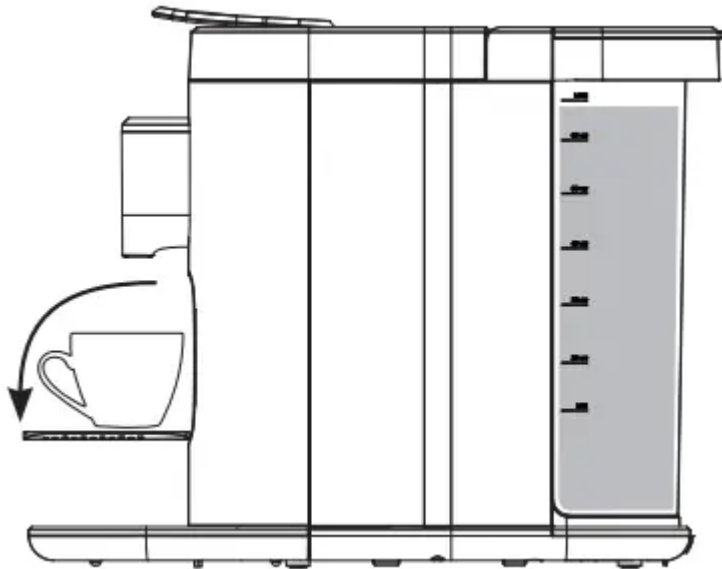

06 Touch the power key. All of the keys illuminate.



07 Touch 2 oz, 4 oz, or 6 oz from the Espresso section, depending on how much coffee you want to brew.

The key flashes as the water heats.



Although all cup sizes illuminate, if you select 8 oz, 10 oz, or 12 oz while an espresso pod is in place, the coffee maker will only dispense water.



6 oz



4 oz



2 oz

08 The key illuminates when the coffee maker starts brewing, and soon hot water pours from the brew spout.

To stop brewing at any time, touch the selected cup size key again.

09 When the water stops dripping, lift the handle to open the top cover.

The pod automatically drops into the used pod container.

Smells heavenly... enjoy!

**NOTICE** DO NOT attempt to brew if the water level is below the MIN fill line as indicated on the water tank.

<b>WARNING</b>		
DO NOT open the top cover while the coffee maker is in operation.	DO NOT touch the blade in the K-Cup holder when the top cover is up.	DO NOT touch the water outlet needle when the top cover is up.

## Brewing tips

Follow these tips and tricks to make sure you're treating yourself to the best cup possible.

<b>Tip</b>	<b>How to do it and why</b>
Make stronger, or espresso-style coffee with your coffee maker.	Choose a smaller cup size to brew a stronger cup.
Make coffee with an espresso pod.	Choose a larger cup size to brew a weaker cup, or, brew a regular espresso, then add water to make it an Americano.
Always use fresh filtered water.	<p>The better the quality of your water, the better tasting your coffee will be!</p> <p>Using filtered water can also help to reduce mineral deposits from accumulating in the coffee maker.</p>
Pre-heat the coffee maker.	<p>If your coffee maker cools between brewing sessions, you may not be getting the best possible flavor.</p> <p>Heat up the coffee maker's internal components to improve the taste of your next cup.</p> <p>To do so, run your desired brewing program without a pod inserted, discard the water, then brew as normal!</p>
Recycle or compost single serve pods.	<p>If you purchase biodegradable pods, the entire pod can be added to a composter.</p> <p>Plastic pods can be recycled if you remove the coffee grounds first.</p> <p>Used coffee grounds can be added to soil to enrich garden beds!</p>
Rinse your K-Cup holder, and/or clean the inlets after brewing.	Residue can alter the taste of your brew. Follow Care, cleaning and storage instructions to clean your inlets and K-Cup holder after using the coffee maker, or, simply run a brew program without a pod installed to rinse the appliance.
Descale and clean your coffee maker frequently.	See Removing mineral deposits for descaling instructions.

## Care, cleaning and storage

Clean your Instant Pod regularly to ensure the best possible flavor, and to prevent scale build-up.

Always unplug the coffee maker and let it cool to room temperature before cleaning. Clean with a damp cloth and wipe dry — never use metal scouring pads, abrasive powders or harsh chemical detergents on any of the coffee maker's parts.

Let all parts dry thoroughly before use, and before storage.

Parts	Cleaning methods and instruction
K-Cup holder	Remove from the coffee maker before cleaning.
Water tank	The water tank is removable for cleaning.
Cup support	The cup support and attached used pod container are removable for cleaning.
Drip tray and drip tray plate	The drip tray and drip tray plate are removable from the coffee maker and come apart for cleaning.
Used pod container	Holds up to 10 used espresso pods at a time. Empty weekly, or more as needed. DO NOT allow pods to sit for longer than 7 days.
Coffee maker exterior	Clean as needed.
Power cord	Clean as needed. DO NOT fold the power cord when storing.



### WARNING

The coffee maker contains electrical components. To avoid fire, electric shock or personal injury:

- HAND WASH ONLY.
- DO NOT rinse or immerse the coffee maker, power cord or plug in water or other liquids.
- DO NOT clean any of the parts or components in a dishwasher.

### Emptying the used pod container

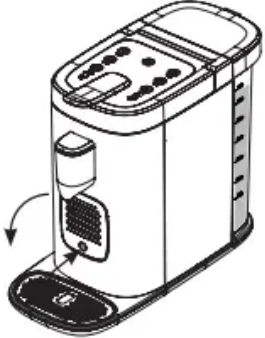
The used pod container can be easily removed to empty and clean.

To remove it	To install it
<p>01 Press on the indent and fold down the cup support.</p>  <p>02 The cup support doubles as a handle. Use it to access the used pod container.</p> <p>03 Remove the container from the coffee maker and empty it.</p> 	<p>01 Insert the container into the opening on the coffee maker.</p> <p>02 Push the container into place.</p> <p>03 If desired, fold up the cup support, or brew a little espresso to congratulate yourself for a job well done!</p>

## Removing mineral deposits

With regular use minerals may accumulate in the coffee maker, which can affect the temperature and strength of your brew.

To make sure your coffee maker stays in tip top shape, descale it regularly to keep mineral deposits from building up.

If you forget, don't worry! After 300 cycles, the 10 oz and 12 oz keys flash to remind you to descale your coffee maker.

Cleaner	Cleaner : Water Ratio
Household descaler	1 : 4
Citric acid	3 : 100

01 Combine cleaner and water as directed above.

02 Make sure the K-Cup holder is in place in the K-Cup inlet.

03 Fill the water tank to the MAX line with the cleaning mixture.

04 Place a large container beneath the drip nozzle. If necessary, remove the entire drip tray from the coffee maker.

05 Touch and hold the 10 oz and 12 oz keys for 3 seconds. The cleaning mixture runs through the appliance until the water tank is empty.

06 Discard the cleaning mixture and replace the container beneath the drip nozzle.

07 Fill the water tank to the MAX line with cool, clean water.

08 Touch and hold the 10 oz and 12 oz keys for 3 seconds. The water runs through the appliance until the water tank is empty.

09 Discard the water.

All done! Is it time for coffee yet?

**CAUTION** Hot water is used for descaling. To avoid risk of scalding personal injury and/or property damage, the container must be large enough to hold the entire contents of the water tank (68 oz / 2000 mL).

## Troubleshooting

Register your Instant Pod today at [instantappliances.com/support/register](https://instantappliances.com/support/register).

Get in touch with a Customer Care Advisor through our chat widget at [instantappliances.com/#chat](https://instantappliances.com/#chat), by email at [support@instantappliances.com](mailto:support@instantappliances.com) or by phone at 1-800-828-7280.

For more troubleshooting tips go to [instantappliances.com/instantpod](https://instantappliances.com/instantpod).

### Resolution table

<b>Problem</b>	<b>Possible reason</b>	<b>Try this</b>
The key indicator light is not on, and/or the coffee maker will not work.	The appliance has been inactive for 30 minutes and has gone to sleep.	Touch the power key to wake the coffee maker.
	The power cord is not inserted into the outlet properly	Inspect the power cord for damage. If damage is noticed, contact Customer Care.  Check the outlet to ensure it is powered.
	The coffee maker's electrical fuse has blown.	Contact Customer Care.
The coffee maker makes a strange noise.	No water in the water tank.	Fill the water tank to between the MIN and MAX lines as indicated on the water tank.
All keys flash simultaneously.	Water tank is empty.	Touch any key to stop the alert.  Fill the water tank to between the MIN and MAX lines as indicated on the water tank.
4 oz and 6 oz keys flash simultaneously.	Internal error.	Contact Customer Care.
10 oz and 12 oz keys flash simultaneously.	Time to descale your coffee maker.	Touch any key to stop the alert. Follow the instructions in Removing mineral deposits.

Any other servicing should be performed by an authorized service representative.



**Warning**

This content is compiled from multiple sources and is provided for reference purposes only. It may not be complete or fully applicable to all situations. If you are unable to resolve your issue, please contact the product manufacturer or an authorized service provider for official support.

---

Document generated by [ManualsFile](#)