

Before you begin

- Carefully read and observe all safety instructions in the safety leaflet
- This soundbar is intended for indoor use only. In case it accidentally gets in contact with small amounts of water, unplug immediately and use a dry cloth to remove the water.
- Unplug the soundbar if it is not used for long periods of time or during lightning storms. e Make sure the soundbar is installed on a solid surface or solidly wall-mounted below your TV for the best experience.
- Only use AAA 1.5V non-rechargeable batteries for the remote control.
- In case any of the cables are visibly damaged or pinched, unplug the soundbar and replace the cable.
- Be careful not to sharply bend the HDMI and optical cable as they may affect the performance.
- Protect your hearing by adjusting to a proper volume.

Overview of the Sound Bar main unit

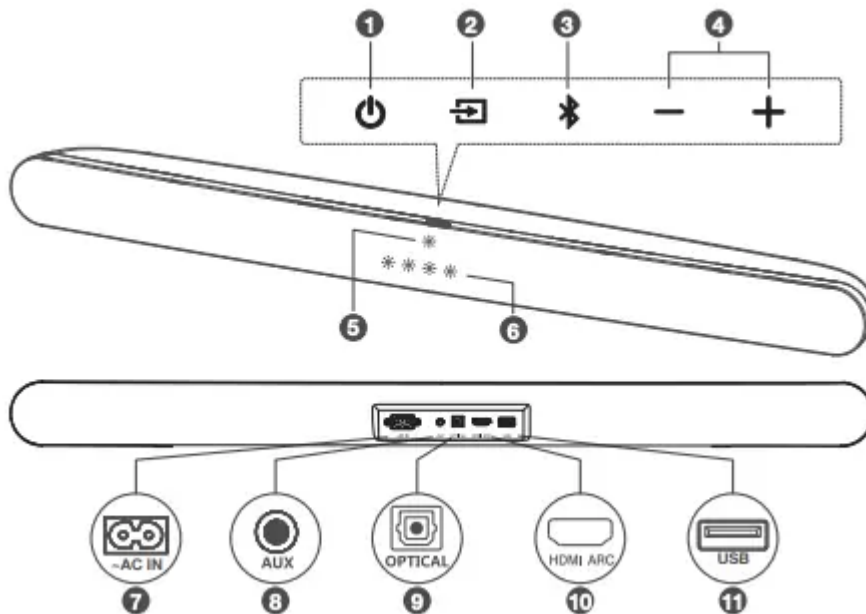

1 

Press to turn the Sound Bar main unit on or to standby mode.

2 

Press to switch the audio source among HDMI/Optical/AUX/USB/Bluetooth modes.

3 

Press to select the Bluetooth function. Press and hold to enter the pairing mode.

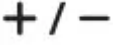
4 

Press to increase or decrease the volume level.

5 LED indicator

- Red: in standby mode.
- Purple: in HDMI ARC mode.
- Green: in AUX mode.
- Blue: in Bluetooth mode.
- Yellow: in Optical mode.
- Cyan: in USB mode.

6 Sound Mode LED indicator

Flashing mode of LED indicators for MUSIC / MOVIE / TV

7 AC input power connector

8 AUX input connector

9 Optical input connector

10 HDMI ARC connector

11 USB Type A connector (only for music playback)

Overview of the wireless subwoofer

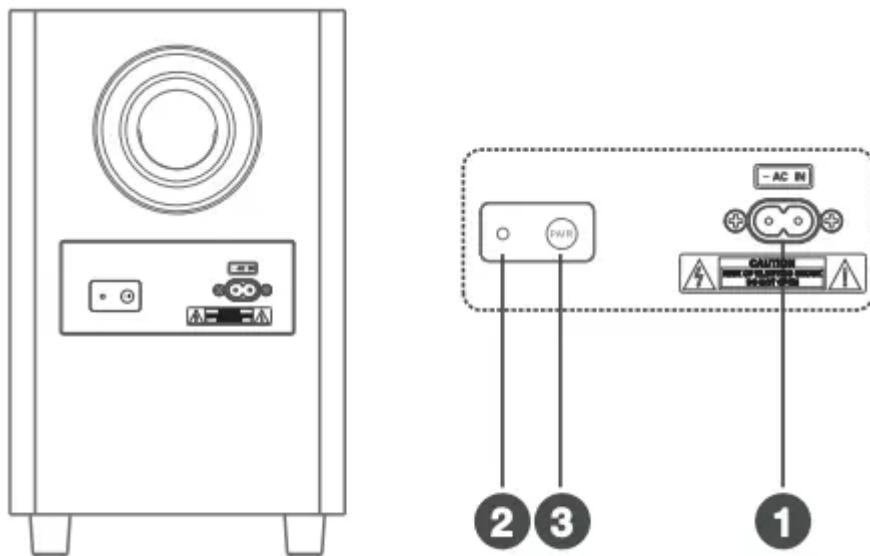

1 AC input power connector

2 Amber LED indicator

- flashes slowly when the subwoofer is in standby mode.
- flashes quickly when pairing is in progress.
- remains on solidly when pairing is successful.

3 PAIR

Press and hold  button on the Sound Bar main unit or the remote control, 4 LEDs flash. Press and hold PAIR button on the subwoofer till the pairing finished. And then the amber LED keep lighting up on the subwoofer.

Overview of the remote control

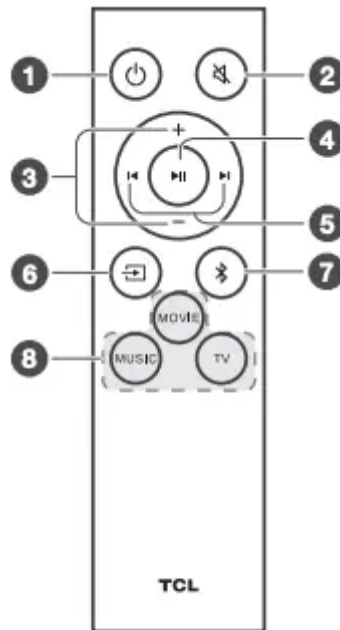

1 

Press to turn the Sound Bar on or to standby mode.

2 

Press to mute or unmute the sound.

3 

Press to increase or decrease the volume level.

4 

Play/pause/resume playback in Bluetooth/USB mode. In Bluetooth mode, press and hold for 3 seconds to disconnect the Bluetooth device and enter pairing status.

5 

Press to skip to previous or next track in Bluetooth/USB mode.

6 

Press to switch the audio source among HDMI/Optical/AUX/USB/Bluetooth modes.

7 

Press to switch the audio source to Bluetooth mode

8 MOVIE / MUSIC / TV

Press to select the equalizer (EQ) effect when you are watching TV or movie or listening to music.

Set up your Sound Bar system

Notes

- Make sure you read all the safety information before you mount the Sound Bar main unit on the wall.
- Make sure you use screws provided or specified by the authorized manufacturer.
- TCL Overseas Marketing Limited bears no responsibility for accidents or damage caused by improper wall mounting and screws installation or insufficient wall strength, etc.
- Additional tools (not supplied) are required for installation.

Mount your Sound Bar main unit on the wall

You can choose to place your Sound Bar main unit below the center of your TV or mount it on the wall.

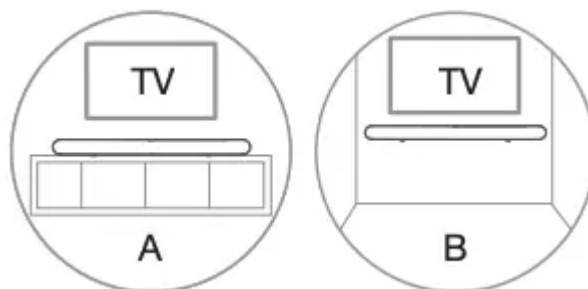

- 1 Place the supplied wall mount template on the wall. Make sure the wall mount template is at least 2 inches (5cm) below the center of the TV.
- 2 Use a level to make sure the wall mount template is positioned accurately.
- 3 Use the tape to stick the wall mount template firmly on the wall.
- 4 Mark on the wall using each marking on the template through the mounting holes.
- 5 Take away the wall mount template.
- 6 Drill a screw hole at each marking on the wall.

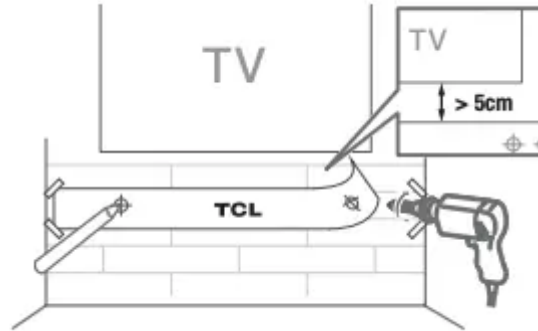

- 7 Screw off the rubber cushions from the soundbar. (Reserve the rubber cushions for future use)
- 8 Screw on the wall brackets to the soundbar.
- 9 Insert the supplied screws into the wall anchors.
- 10 Fix and tighten the screws on the wall, and please leave 0.16 inches (4mm) between the screw heads and the wall.

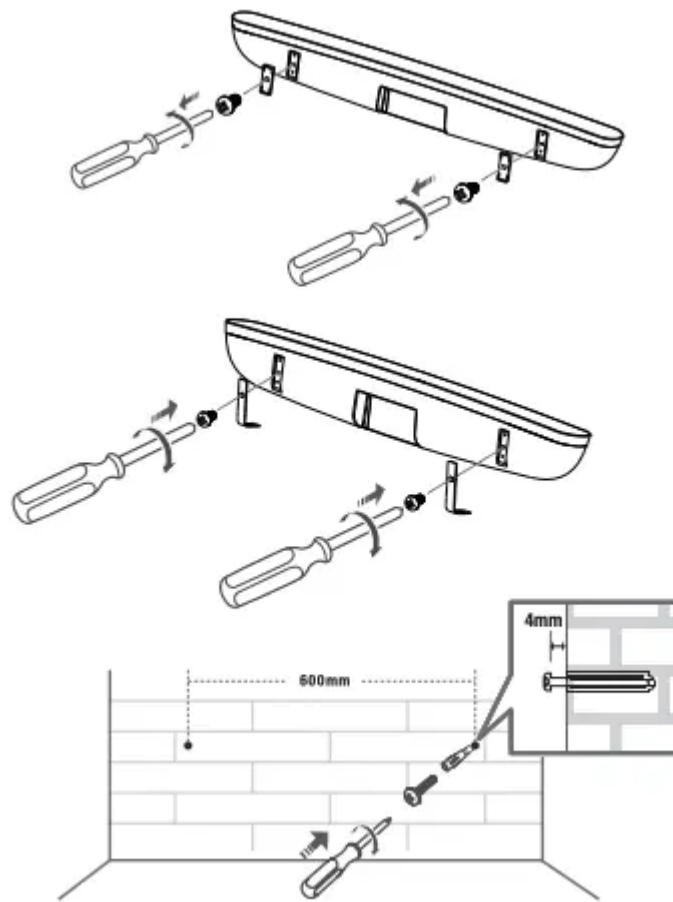

11 Hang the Sound Bar main unit on the screws.

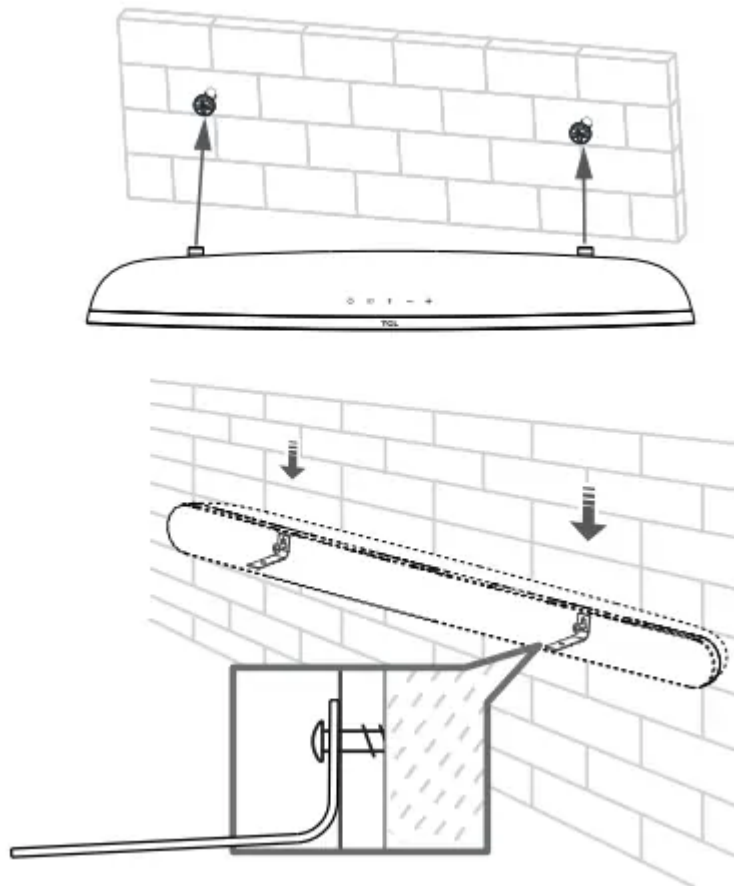

Notes

- Check the installation location before you mount the Sound Bar on the wall (see 'Mount your Sound Bar main unit on the wall' on page 11).
- You may consider to connect the cables first before mounting the Sound Bar on the wall.

Position your subwoofer

The distance between the subwoofer and the Sound Bar main unit should be within 9.8 feet (3 meters).

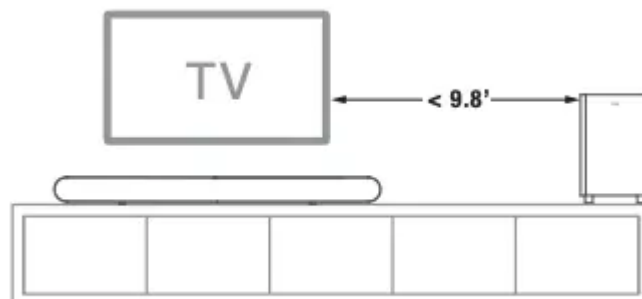

Install/replace the remote control batteries

Warnings

Danger of explosion if battery is incorrectly replaced. Replace only with the same or equivalent type.

Caution

The battery contains perchlorate material, handle it with care. For information, refer to www.dtsc.ca.gov/hazardouswaste/perchlorate

- 1 Open the battery compartment, remove the old batteries if necessary.
- 2 Place two new AAA batteries into the battery compartment with the correct polarity (+/-).
- 3 Close the battery compartment.



Connect your Sound Bar system

After you have fixed the position of the Sound Bar main unit, you can start connecting it to your TV or other devices and listen to the audio through your Sound Bar. Make sure you have muted the audio of your TV or device. For information, check the user manual of your TV or device.

Connect with the HDMI cable

Note

- Make sure your TV or device supports the HDMI ARC. feature. For information, check the user manual of your TV or device.

Connect one end of the HDMI cable to the HDMI ARC input connector on your Sound Bar main unit and another end to the HDMI ARC output connector of your TV or device.

To get the best possible audio experience using the HDMI cable, follow below given steps:

- 1 Connect your Sound Bar to HDMI input marked (ARC) on your TCL TV.
- 2 Press the Settings button on your TCL TV remote.
- 3 Navigate to System options.
- 4 Set T-Link to On. (This feature may be called, Anynet+, SimpLink, BRAVIA Link, EasyLink or VIERA Link*.)

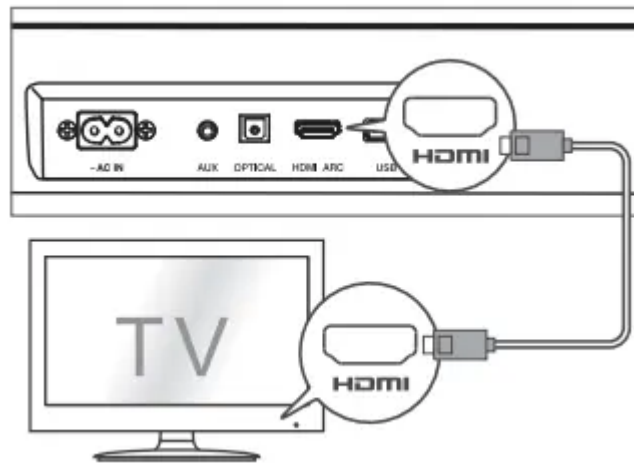

Connect with the optical cable

- 1 Remove the protective caps from the optical cable when necessary.
- 2 Connect one end of the optical cable to the optical input connector on your Sound Bar main unit and another end to the optical output connector of your TV or device.

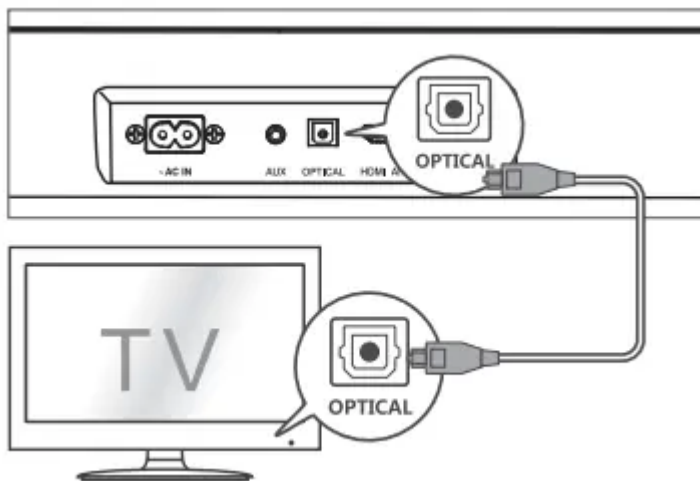

Note

If there is no sound output from the Sound Bar main unit and the yellow LED flashes rapidly, try to activate the PCM signal output on your TV or device. PCM is used to convert analog audio signals into digital audio signals in most devices. For more information of how to activate the PCM signal output, check the user manual of your TV or device.

Direction for setting up your Sound Bar using an optical cable



Do not bend or kink the optical cable (SPDIF) as it is fragile and can easily get damaged and broken.

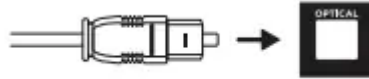

To get the best possible audio experience using the optical cable:

- 1 Press the Settings button on your TCL TV remote.
- 2 Navigate to Audio options.
- 3 Set TV speakers to Off.

Connect with the 3.5mm-to-3.5mm audio cable

You can either:

- connect one end of the 3.5mm-to-3.5mm audio cable (sold separately) to the AUX input connector on your Sound Bar main unit and another end to the headphone or audio output connector on your TV or device. This will disable the sound of your TV built-in speakers; or
- connect one end of an RCA-to-3.5mm audio cable (sold separately) to the AUX input connector on your Sound Bar main unit and other ends to the TV's audio output connectors.

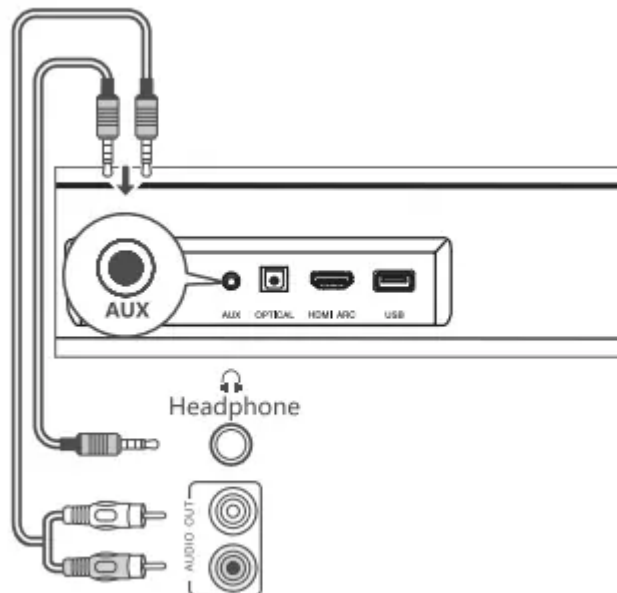

Connect your Sound Bar to power supply

- 1 Make sure that you have completed all other connections before connecting the Sound Bar to power supply.

2 Make sure the power supply voltage complies with your country's safety standards (see 'Specifications' on page 33)

3 Connect one end of another supplied AC power cord to the AC input connector on your subwoofer and another end to the power socket on the wall.

4 Connect one end of a supplied AC power cord to the AC input connector on your Sound Bar main unit and another end to the power socket on the wall.

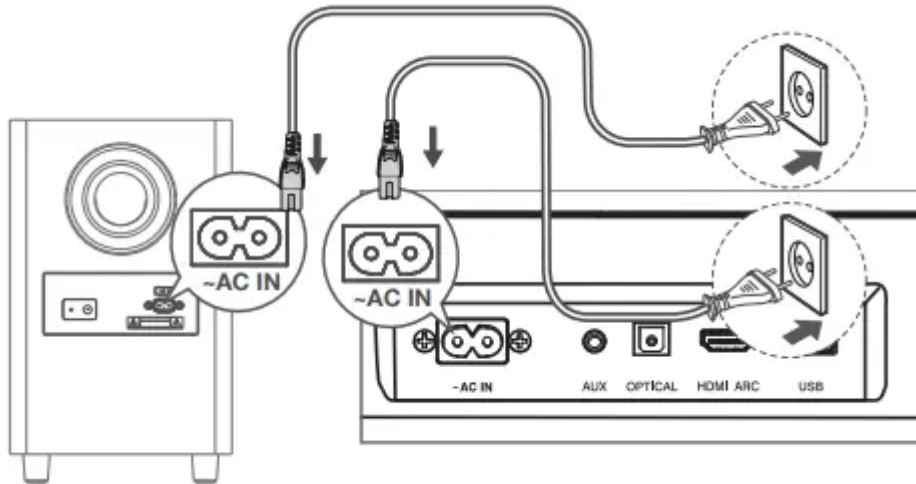

Connect the Sound Bar with your Bluetooth device

Notes

- Make sure your wireless device supports the Bluetooth function.
- The operational range between the Sound Bar main unit and your Bluetooth device is approximately 10 meters (without any obstacle between the Bluetooth device and Sound Bar main unit).

1 Press  on the top panel of your Sound Bar main unit or remote control to power on the Sound Bar.

2 Press and hold  on the top panel of your Sound Bar main unit or remote control.

3 Power on your Bluetooth device and activate its

→ The blue LED flashes quickly. The Sound Bar is ready to pair. Bluetooth function.

4 Select TCL Alto 6+ on the pairing list of your Bluetooth device.

→ You hear distinct double beep sound.

→ The blue LED remains on solidly when pairing is successful.

Tip

- If you cannot find the model name TCL Alto 6+ on your Bluetooth device. press and hold **▶||** on the remote control. You will see the blue LED flashes rapidly. Now the Sound Bar main unit is entering the pairing mode.

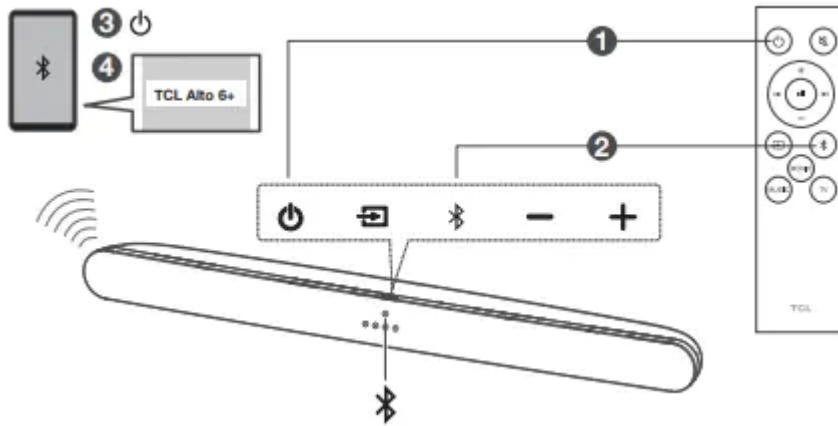

Your Sound Bar system is now set up and ready to use.

5 To disconnect the Bluetooth function, you can:

- press **↔** on the Sound Bar main unit or remote control to switch to another source; or
- disable the Bluetooth function on your device; or
- press and hold **▶||** on the remote control for 3 seconds.

Connect your wireless subwoofer to the Sound Bar

When the wireless subwoofer is connected, you can enjoy powerful deep bass sounds and a truly immersive audio experience.

Auto pairing

Make sure both the Sound Bar and wireless subwoofer are connected to the power supply and are turned on.

- The Sound Bar will pair with the subwoofer automatically.
- The amber LED will flash when pairing is in progress.
- The amber LED will remain on solidly when pairing is successful.

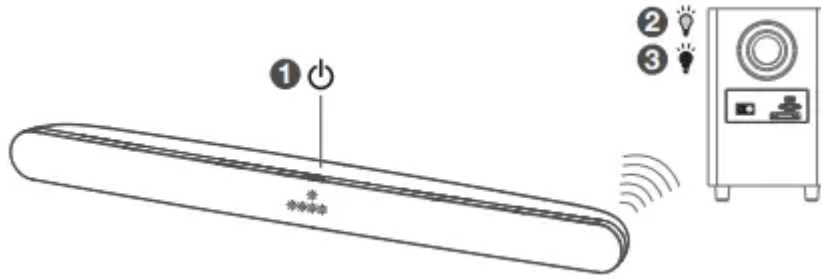

Note

- Do not press PAIR at the back of the wireless subwoofer during auto pairing.

Manual pairing

1 Make sure the Sound Bar and wireless subwoofer are properly connected to the power supply.

2 Press and hold  button on the Sound Bar main unit or the remote control,

→ 4 LEDs flash.

3 Press PAIR at the back of the wireless subwoofer until the amber LED on the subwoofer flashes quickly.

→ The wireless subwoofer is ready to pair.

→ Pairing is successful. The amber LED remains on solidly

Note

- If the amber LED at the back of the subwoofer still flashes after pairing, it means pairing is not successful. Disconnect the AC power cord from the wireless subwoofer and then connect again after 3 minutes. Then repeat steps 1 to 3.

Use your Sound Bar system

Use your Sound Bar with the top panel or remote control

1 Make sure the Sound Bar is properly connected to the power supply and sources.

2 Press  at the top panel of your Sound Bar main unit or remote control to switch to the correct source.

LED behaviors under different source modes

LED indicators -- Source mode

Red -- In standby mode

Purple -- in HDMI ARC mode

Green -- in AUX mode

Blue -- in Bluetooth mode

Blue LED flashes slowly -- search the paired devices

Blue LED flashes quickly -- pairing in progress

Yellow -- in Optical mode

Cyan -- in USB mode

Note



- After powering on your Sound Bar, if there is no operation performed on either the Sound Bar main unit or remote control within 10 seconds, all LED indicators on the Sound Bar main unit will turn off and light up again when the operation is resumed.





Tip

- You can use more advanced functions on the remote control (see Overview of the remote control on page 9).

Sound settings

You can enjoy your movies or music with your ideal sound.

- Press +/- to adjust the volume.
- Press  on the remote control to mute the sound. Press  again to unmute the sound.
- Press the EQ buttons (MOVIE/MUSIC/TV) on the remote control to select the equalizer (EQ) effect when you are watching TV or movies or listening to music.



Symbol	Operation	LED indicators
+	Volume up	The four white LEDs light up gradually from left to right
-	Volume down	The four white LEDs fade gradually from right to left
	Volume up to Maximum	The four white LEDs flash twice
	Volume down to Minimum	The left white LED flashes twice
	Mute the Sound	The white LED keeps flashing
	Unmute the Sound	The four white LEDs flash once and disappear
	Select the equalizer (EQ)	MUSIC  MOVIE  TV 

Listen to music from your Bluetooth device

1 Make sure that your device supports A2DP and/or AVRCP. For information, check the specification of your device.

2 Pair your Bluetooth device with the Sound Bar main unit (see 'Connect the Sound Bar with your Bluetooth device' on page 29).

3 Start listening to music stored in your Bluetooth device through the Sound Bar.

- If your Bluetooth device supports A2DP, you can listen to music, but you cannot control the playback.
- If your Bluetooth device supports AVRCP, you can listen to music and control music playback with the remote control. Press  to pause or resume music playback. Press  to skip to the previous/next track.

Note





The operational range between the Sound Bar main unit and your Bluetooth device is approximately 10 meters (without any obstacle between the Bluetooth device and Sound Bar main unit).

Use the USB cable or device for music playback

1 Connect the USB device to the USB Type A connector on your Sound Bar main unit.

2 Press  on the Sound Bar main unit or remote control. until the cyan LED is on.

You can now listen to music through the Sound Bar.

- To pause or resume music. press  or  on the remote control.
- To skip to the previous or next track. press  or  on the remote control.

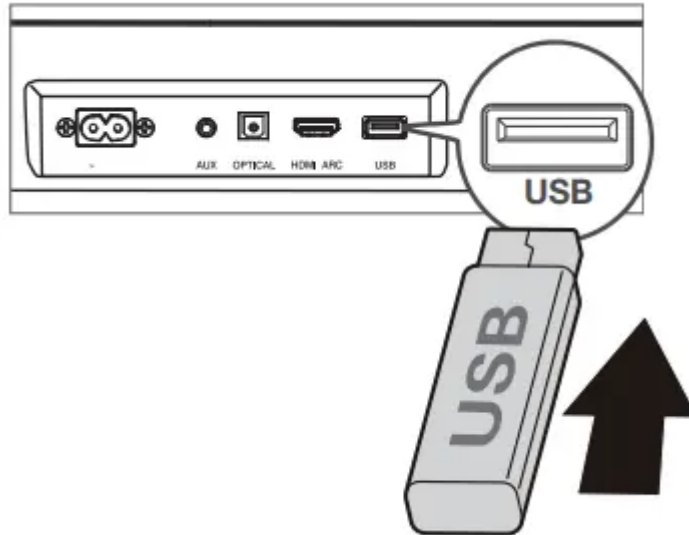

Operation -- LED indicators

Listen to music. -- The cyan LED is on.

Press to pause the music. -- The cyan LED keeps flashing

Tip

- This Sound Bar can support USB devices of up to 32GB memory and the supported file format is MP3.

FAQ

No power

- Make sure the AC power cord and AC input connector are connected properly.
- Make sure there is power supply.
- Make sure the Sound Bar has turned on.

No sound

- Make sure the audio cable is connected to the Sound Bar and your device.
- Make sure you have selected the correct source.
- Press + to increase the volume level.
- Make sure the Sound Bar is not muted.

The remote control does not work.

- Make sure you have selected the correct source.
- Make sure the distance of remote control and the Sound Bar main unit is within operational range.
- Make sure the battery is correctly inserted and is working.
- Make sure the remote control is close to the remote control sensor of the Sound Bar main unit.

I hear distorted sound.

- Make sure all cables are properly connected.
- Make sure you have selected the correct source.
- Make sure the TV is muted if you play audio from the TV.

I cannot find the Bluetooth name of this Sound Bar on my Bluetooth device.

- Make sure the Bluetooth function is activated on your Bluetooth device.
- Make sure the Sound Bar has paired with your Bluetooth device.

The LED indicator of the subwoofer is off

- Reset the subwoofer by disconnecting the power supply and reconnecting after 2 minutes.

Warning

This content is compiled from multiple sources and is provided for reference purposes only. It may not be complete or fully applicable to all situations. If you are unable to resolve your issue, please contact the product manufacturer or an authorized service provider for official support.