

Getting to Know Your 19 Bar Espresso & 10 Cup Programmable Coffee Maker

Product may vary slightly from illustration

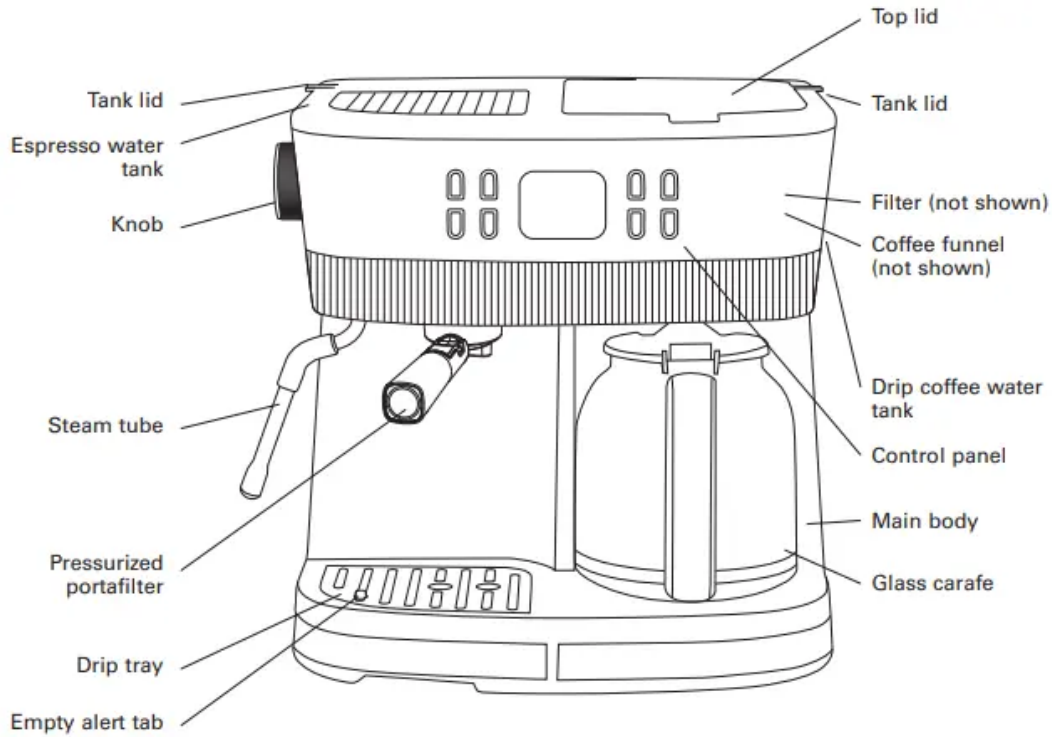





CONTROL PANEL



Buttons and Indicators

"POWER" button
"STEAM PREHEAT" button
 button
 button
"MINUTE" button
"HOUR" button
"PROGRAM" button
"BREW-OFF" button

LCD display

12:88: Clock
: Coffee strength setting: Light
: Coffee strength setting: Medium
: Coffee strength setting: Strong
: Coffee strength setting: Extra-strong
"CLEAN": The appliance needs to be cleaned
: Sound off

BEFORE FIRST USE

Check that all accessories are complete and the unit is not damaged. Clean all detachable parts well and understand all the parts and their functions. Add water into water tank to the max level and brew water for several times without coffee powder, then discard the water.

OPERATION

The appliance has two brewing systems including "Drip coffee-brewing system" and "Espresso-brewing system."

MAKE DRIP COFFEE

1. Open the drip coffee water tank lid and add some drinking water into the drip coffee water tank.

NOTE: Do not fill the water tank with water exceeding the max level as indicated on the water level gauge. The appliance can brew max 10 cups of coffee every brewing cycle.

2. Put the filter into the coffee funnel and then place the coffee funnel into the funnel holder, make sure the coffee funnel should be installed well in place.

3. Add proper coffee powder into the filter. Usually a cup of coffee needs a level spoon of coffee powder, but you may adjust according to personal taste. It is recommended to add 10 cups of water and 60g of coffee powder. And then replace the top lid.

4. Insert the glass carafe with lid in place onto warming plate horizontally, ensure the center line of carafe aligns with the anti-drip valve.

5. Connect the appliance with power source, all icons will show on LCD display & all LED indicators turn on for 2 seconds with one beep sound, then the "STRENGTH" with one bean, AM & TIME would light solidly, and you can use "HOUR" and "MINUTE" buttons to adjust the time. After setting time, the appliance will return to standby mode, at that time, the LCD just show time with PM (or AM) & the "Strength with one bean".

6. Press “BREW-OFF” button, the appliance starts to work and brew coffee.

WARNING: Do not open the top lid to avoid being burnt during operation.

NOTE: Only the “BREW-OFF” button can work during the brewing process.

7. After a while, the coffee dispenses from the coffee outlet and flows into the glass carafe.

After finish brewing, the appliance will stop working and enter into the keep-warm mode, the “Time since brew” will show on LCD and the white background will turn off.

NOTE: You can take out the glass carafe and pour coffee for serving at any time, and the appliance will stop dripping automatically. But the time cannot exceed 30 seconds.

8. After finish brewing, the appliance will have 3 beeps sound for keep warm (if the beep sound does not turn off).

9. To set the time under the standby mode, hold and press “HOUR” or “MINUTE” button for 3 seconds, the “Time”, will flash while the “Strength with one bean” still lights solidly. Then you can use “HOUR” and “MINUTE” buttons to set the time, After setting the time, the time will continuous flash for 5 seconds and press “PROGRAM” button to confirm the time, and then the appliance returns to standby mode.

10. To set the coffee strength, hold and press “PROGRAM” button for 3 seconds, the LCD will show time, “PM” or “AM”, and the “Strength with one bean” flashes, press “PROGRAM” button to adjust the coffee strength (one bean, two beans, three beans and 1-4cup in sequence). After setting the coffee strength, the selected coffee strength will continuous flash for 5 seconds for confirmation and then the appliance will return to standby mode.

11. To set the auto-off time, hold and press “BREW-OFF” button for 3 seconds, the coffee strength will show on LCD display and the auto-off time flashes. Then you can use “HOUR” and “MINUTE” button to adjust the keep warm time (0’00”~4’00”, 15min increment). After setting the time, the time will continuous flash for 5 seconds for confirmation and then the appliance will return to standby mode.

12. To set the auto-on time, press the “PROGRAM” button, and its corresponding indicator turns on, the “Program”, “PM” or “AM” icons will show on LCD display and the auto on time flashes, and the “Strength with one bean” still lights solidly. And you can use “HOUR” and “MINUTE” buttons to adjust the auto-on time, After setting the time, press “PROGRAM” to confirm setting before flash end, otherwise setting is not recorded. To cancel the setting, press the “PROGRAM” button again, and its corresponding indicator will turn off and the “Program” icon will disappear from LCD.

NOTES:

(1) During the working of Drip coffee-brewing system, the Espresso-brewing system cannot work.

(2) During the keep-warm stage, the Espresso-brewing system can work, but both heaters cannot turn on at same time.

(3) The appliance has 1~3mins memory time.

13. When the appliance has finished 300 cycles of brewing drip coffee, the “Clean” icon will flash on LCD to indicate the appliance needs to be cleaned. To enter the cleaning mode, hold and press both of “HOUR” and “MINUTE” buttons for 3 seconds, the “Clean” icon will show on LCD and press the “BREW-OFF” button to start the clean cycle.

14. Always turn the appliance off and disconnect the power supply when not use.

NOTE: Pay attention to pour the coffee out, otherwise you may be hurt as the temperature of coffee brewed is high.

MAKE ESPRESSO

1. Open the Espresso water tank lid and add some drinking water into the Espresso water tank.

NOTE: Do not fill the water tank with water exceeding the max level as indicated on the water level gauge.

2. Select the one-cup filter or two-cup filter according to your demand and then install it into the pressurized portafilter, then add proper coffee powder into the filter. It is recommended to add 7g of coffee powder when brewing one-cup Espresso and add 14g of coffee powder when brewing two-cup Espresso. Tamp the coffee powder with the tamper, and then attach the pressurized portafilter onto the appliance.

3. Put a container onto the drip tray to collect the coffee. Ensure the center line of carafe aligns with the pressurized portafilter.

4. Connect the appliance with power source, all icons will show on LCD display & all LED indicators turn on for 2 seconds with one beep sound, then the “STRENGTH” with one bean, AM & TIME would light solidly.

5. Press “Power” button to turn on the Espresso-brewing system, the water pump will keep working for 3 seconds with the LED indicators of “POWER” & “STEAM/PREHEAT” buttons turn on, the LED indicators of “One cup” & “Two cup” buttons flash. All the LED indicators will turn on once the preheating is finished.

6. Press “One cup” or “Two cup” button, the LED indicator of “POWER” button turns on and the LED indicator “One cup” or “Two cup” button flashes. And the appliance starts working. After finish brewing, the appliance will return to the standby mode. Only the selected button and “POWER” button can work during the brewing process.

7. To adjust the coffee volume, hold and press “One cup” or “Two cup” button for 3 seconds, the LED indicator of the selected button flashes and the LED indicator of “POWER” button

lights up. Release the selected button once desired volume is reached. And the appliance will return to the standby mode after the coffee volume is adjusted.

8. To reset the coffee volume to factory setting, hold and press both of the “One cup” and “Two cup” button for 3 seconds, then the “Power”, “One cup”, “Two cup” buttons flash for 5 times, which means the coffee volume has been reset and then the appliance will return to the standby mode.

9. When the “POWER” button is on and “One cup”, “Two cup” and “STEAM/PREHEAT” buttons are blinking indicate that there is no water in the water tank during brewing.

10. The red buoy will float when the drip tray is full of water. Please empty the drip tray in time.

11. During brewing cycle, if there is no water in the water tank, the LED indicators of “POWER” button is on and “One cup”, “Two cup” and “STEAM/PREHEAT” buttons will blink.

12. If the user wants to empty the water inside Espresso water tank after long time of no use, hold and press both of “STEAM/PREHEAT” & “Two cup” button for 3 seconds, the water pump will work only to drain out the water into Drip Tray until there is no water inside the water tank, then the appliance will return to the standby mode.

13. Always turn the appliance off and disconnect the power supply when not use.

NOTE: If the user uses Espresso side first, after use or under the standby mode, if the user press “BREW-OFF” button, its corresponding LED indicator and the white background will turn on, and the LED indicator of “POWER” button will keep illuminating, while the LED indicators of “One cup”, “Two cup” and “STEAM/PREHEAT” buttons will turn off.

MAKE STEAM/HOT WATER

1. Open the Espresso water tank lid and add some drinking water into the Espresso water tank.

NOTE: Do not fill the water tank with water exceeding the max level as indicated on the water level gauge.

2. Connect the appliance with power source, the , press “POWER” button, the indicators of “POWER” button and “STEAM/PREHEAT” buttons illuminate, and the indicators of “One cup” and “Two cup” buttons flash, then the appliance enters into the preheating mode.

NOTE: If the knob stays at “Steam” or Hot Water” position before press the “POWER” button, the LED indicator of “POWER” button and “STEAM/PREHEAT” button will flash until the knob is rotated to “OFF” position.

3. Press “STEAM/PREHEAT” button, the LED indicator of “POWER” button illuminates, and the LED indicator of “STEAM/PREHEAT” button flashes, the heater will work to preheat the appliance. Once the preheating is finished, the LED indicator of “STEAM/PREHEAT” button lights solidly.

4. Rotate the knob to “Steam” position, the water pump starts working. If the heater works again, the LED indicator of “STEAM/PREHEAT” button will flash, if not, the LED indicator of “STEAM/PREHEAT” button will illuminate.

5. Rotate the knob back to “OFF” position, the appliance will stop producing steam, and the water pump will work with the LED indicators of “One cup”, “Two cup” and “STEAM/PREHEAT” buttons flash for cooling down the heater for the next working cycle. And then the appliance will return to the standby mode.

6. During the standby mode for steam function, the LED indicators of “POWER” and “STEAM/PREHEAT” buttons illuminate. The appliance will exit from the steam function if press “STEAM/PREHEAT” button again. And the water pump will work with the LED indicators of “One cup”, “Two cup” buttons flash for cooling down the heater for the next working cycle. And then the appliance will return to the standby mode. And the appliance will turn off if press “POWER” button.

NOTE: For steam function, the maximum working time is 2 minutes.

7. Under the standby mode, rotate the knob to “Hot water” position, the LED indicators of “POWER”, “One cup” and “Two cup” buttons illuminate, and the water pump starts working for the hot water function. Rotate the knob back to “OFF” position, the appliance will stop producing hot water and return to the standby mode.

NOTE: For hot water function, the maximum working time is 1 minute.

8. During brewing cycle, if there is no water in the water tank, the LED indicators of “One cup”, “Two cup” and “STEAM/PREHEAT” buttons will flash and you can press Power, One Cup or Two Cup to remove warning.

9. If the user wants to empty the water inside Espresso water tank after long time of no use, hold and press both of “STEAM/PREHEAT” & “Two cup” button for 3 seconds, the water pump will work only to drain out the water until there is no water inside the water tank, then the appliance will return to the standby mode.

10. Always turn the appliance off and disconnect the power supply when not use.

STANDBY MODE

The appliance will enter into sleep mode automatically if there is not any operation within 30 seconds under the standby mode.

TO TURN OFF OR TURN ON THE BEEP

To turn off the beep, simultaneously hold and press “PROGRAM” and “MINUTE” buttons for 3 seconds, the icon “” shown in the LCD illuminates. To turn on the beep, simultaneously

hold and press “PROGRAM” and “MIN” buttons for 3 seconds again, the icon “” will disappear from LCD.

CLEANING AND MAINTENANCE

CAUTION: Be sure to unplug this appliance before cleaning and let the appliance cool down completely. To protect against electrical shock, do not immerse cord, plug or unit in water or liquid.

1. Clean all detachable parts such as filter and funnel with warm water.
2. Push the anti-drip valve upwards for 3-4 times to empty the residual water.
3. Wipe external surface of product with a soft, damp cloth to remove stains.
4. Water droplets may buildup in the area above the coffee funnel and drip onto the product base during brewing. To control the dripping, wipe off the area with a clean, dry cloth after each use of the product.
5. Wipe the warming plate with a piece of wet cloth, do not use abrasive cleaning agent for cleaning.
6. The LCD display will show “CLEAN” when the appliance has performed 300 cycles of brewing drip coffee. At that time, “CLEAN” blinks. Simultaneously hold and press “HOUR” and “MIN” buttons for 3 seconds to enter into the cleaning mode, the “CLEAN” icon will show on LCD and press “BREW/OFF” button to start the clean cycle. After the clean cycle is finished, the “CLEAN” icon will disappear from the LCD.
7. Replace all parts and keep for next use.

REMOVING MINERAL DEPOSITS

To keep your coffee maker operating efficiently, periodically you should clean away the mineral deposits left by the water according to the water quality in your area and the use frequency, we recommend removing mineral deposits as follows:

1. Combine 6 cups of white vinegar and 4 cups of cold water in carafe.
2. Pour into water reservoir.
3. Insert filter basket into the filter basket holder and close lid.
4. Make sure the lid on the carafe is in place, and place the empty carafe on the keep warm plate.
5. Press and hold the HOUR and MINUTE buttons for 3 seconds until “CLEAN” appears on the LCD display.
6. Press the “BREW-OFF” button to start the cleaning cycle. The light around the “BREW-OFF” button will turn on and the unit will beep.

7. Once the cleaning cycle is complete, the light around the “BREW-OFF” button will turn off and the unit will beep.
8. Discard all water/vinegar solution from carafe & water tank.
9. Repeat the brew cycle 2-3 times with cold water before brewing coffee again

HINTS FOR GREAT-TASTING COFFEE

1. A clean coffee maker is essential for making great-tasting coffee. Regularly clean the coffee maker as specified in the “CLEANING AND MAINTENANCE” section. Always use fresh, cold water in the coffee maker.
2. Store unused coffee powder in a cool, dry place. After opening a package of coffee powder, reseal it tightly and store it in a refrigerator to maintain its freshness.
3. For an optimum coffee taste, buy whole coffee beans and finely grind them just before brewing.
4. Do not reuse coffee powder since this will greatly reduce the coffee' flavor. Reheating coffee is not recommended as coffee is at its peak flavor immediately after brewing.
5. Clean the coffee maker when over-extraction causes oiliness. Small oil droplets on the surface of brewed, black coffee are due to the extraction of oil from the coffee powder.
6. Oiliness may occur more frequently if heavily roasted coffees are used.

IMPORTANT SAFEGUARDS

When using electrical appliances, basic precautions should always be followed, including the following:

1. READ ALL INSTRUCTIONS.
2. Before using check that the voltage power corresponds to the one shown on the appliance nameplate.
3. Do not operate any appliance with a damaged cord or plug or after the appliance malfunctions, or has been damaged in any manner. Return appliance to the nearest authorized service facility for examination, repair or adjustment.
4. To protect against fire, electric shock and injury to persons do not immerse cord, plug, or in water or other liquid.
5. Close supervision is necessary when any appliance is used by or near children.
6. Unplug from outlet when not in use and before cleaning. Allow to cooling before putting on or taking off parts, and before cleaning the appliance.
7. The use of accessory not recommended by the appliance manufacturer may result in fire, electric shock or injury to persons.

8. Do not use outdoors.
9. Do not let cord hang over edge of table or counter, or touch hot surface.
10. Do not place on or near a hot gas or electric burner, or in a heated oven.
11. Do not use appliance for other than intended use.
12. Do not set a hot container on a hot or cold surface.
13. Do not let the coffee machine operate without water.
14. The container is designed for use with this appliance. It must never be used on a range top.
15. Do not clean container with cleansers, steel wool pads, or other abrasive material.
16. To disconnect, turn any control to "OFF", remove plug from wall outlet. Always hold the plug. But never pull the cord.
17. Scalding may occur if the top lid is opened during the brewing cycles. Be careful not to get burned by the steam.
18. Some parts of appliance are hot when operated, so do not touch with hand. Use handles or knobs only.
19. Never leave the empty carafe on the warming plate otherwise the carafe is liable to crack.
20. Never use the appliance if the carafe shows any signs of cracks or carafe having a loose or weakened handle. Only use the carafe with this appliance. Use carefully as the carafe is very fragile.
21. Never place the carafe on a hot surface.
22. The appliance must not be immersed.
23. This appliance is not intended for used by persons (including children) with reduced physical, sensory or mental capabilities, or lack of experience and knowledge, unless they have been given supervision or instruction concerning use of the appliances by a person responsible for their safety.
24. Children should be supervised to ensure that they do not play with the appliance.
25. Do not use outdoors.

SAVE THESE INSTRUCTIONS HOUSEHOLD USE ONLY

Notes on the plug:

This appliance has a polarized plug. To reduce the risk of electric shock, this plug is intended to fit into a polarized outlet only one way. If the plug does not fit fully into the outlet, reverse the plug. If it still does not fit, contact a qualified electrician. Do not attempt to modify the plug in any way.

Notes on the cord:

(a) A short power-supply cord (or detachable power-supply cord) is provided to reduce risks resulting from becoming entangled in or tripping over a longer cord.

(b) Longer detachable power-supply cords or extension cords are available and may be used if care is exercised in their use.

(c) If a long detachable power-supply cord or extension cord is used:

(1) The marked electrical rating of the detachable power-supply cord or extension cord should be at least as great as the electrical rating of the appliance;

(2) If the appliance is of the grounded type, the extension cord should be a grounding-type 3-wire cord; and

(3) The longer cord should be arranged so that it will not drape over the counter top or table top where it can be pulled on by children or tripped over.

Plasticizer Warning

CAUTION: To prevent Plasticizers from migrating to the finish of the counter top or table top or other furniture, place NON- PLASTIC coasters or place mats between the appliance and the finish of the counter top or table top. Failure to do so may cause the finish to darken; permanent blemishes may occur or stains can appear.

Electric Power

If the electrical circuit is overloaded with other appliances, your appliance may not operate properly. It should be operated on a separate electrical circuit from other appliances.

Coffee Yield

10 Cup Coffee Maker: 10 (5 oz.) cups

NOTE: A 5-oz.cup is the American industry standard and is used by most Coffee Maker manufacturers. To fill your favorite over-sized mug, fill Coffee Maker reservoir with enough water for 3 to 4 cups (15 to 20 ounces).

WARNING: TO AVOID THE RISK OF FIRE OR ELECTRIC SHOCK, DO NOT UNSCREW THE UNDER SIDE COVER. THERE ARE NO USER-SERVICEABLE PARTS INSIDE. REPAIR SHOULD BE DONE BY AUTHORIZED SERVICE PERSONNEL ONLY.

Warning

This content is compiled from multiple sources and is provided for reference purposes only. It may not be complete or fully applicable to all situations. If you are unable to resolve your issue, please contact the product manufacturer or an authorized service provider for official support.

