

Parts and controls

Main unit

DMH - 342EX / 341EX / 340EX

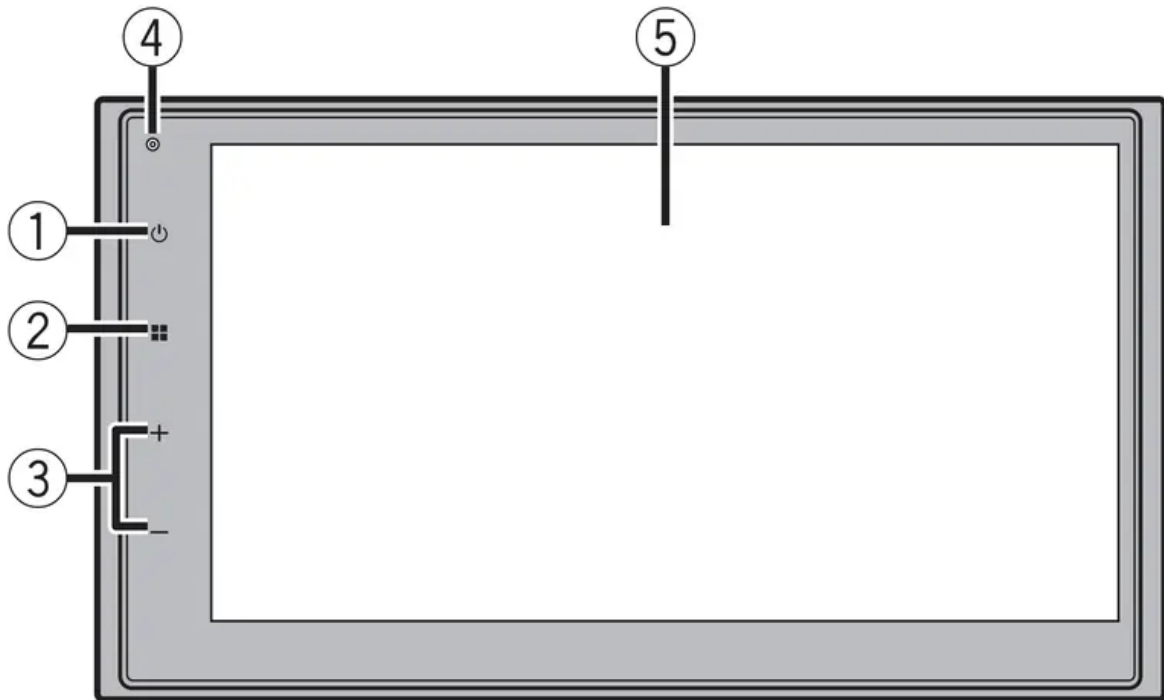

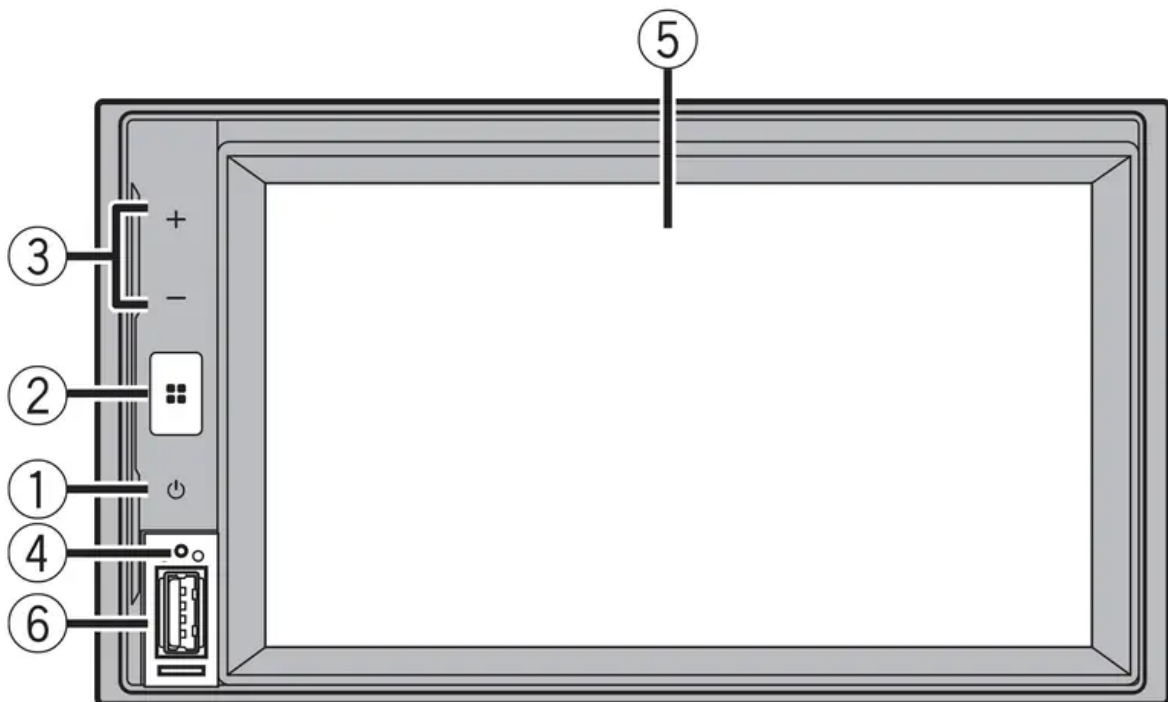

DMH - 241EX / 240EX

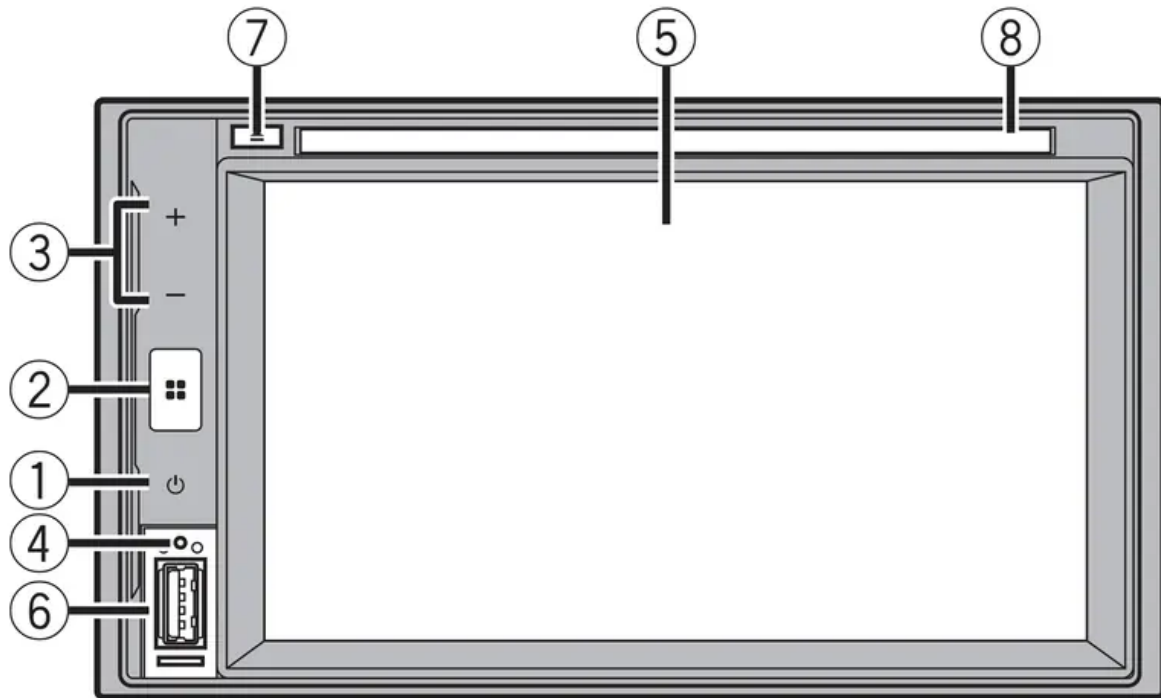

AVH - 241EX / 240EX



①		<p>Press to turn off the display information. To turn on the display information, press again. Press and hold to power off. To power back on, press again.</p> <p>TIP If you power the unit off, you can turn off almost all functions. The unit turns on by operating the following functions:</p> <ul style="list-style-type: none"> • A rear view camera image is input when the vehicle is in reverse. • The ignition switch is turned off (ACC OFF), then turned on (ACC ON). <p>NOTE If you display the image from the back camera while the power is off, the image may be displayed on the rear monitor instead.</p>
②		<p>Press to display the top menu screen. Press and hold to mute or unmute.</p>
③	VOL (+/-)	
④	RESET	Press to reset the microprocessor (page 11).
⑤	LCD screen	
⑥	USB port	
⑦		Press to eject a disc.*
⑧	Disc loading slot*	

* AVH-241EX, AVH-240EX

Remote control

342EX / 341EX / 241EX



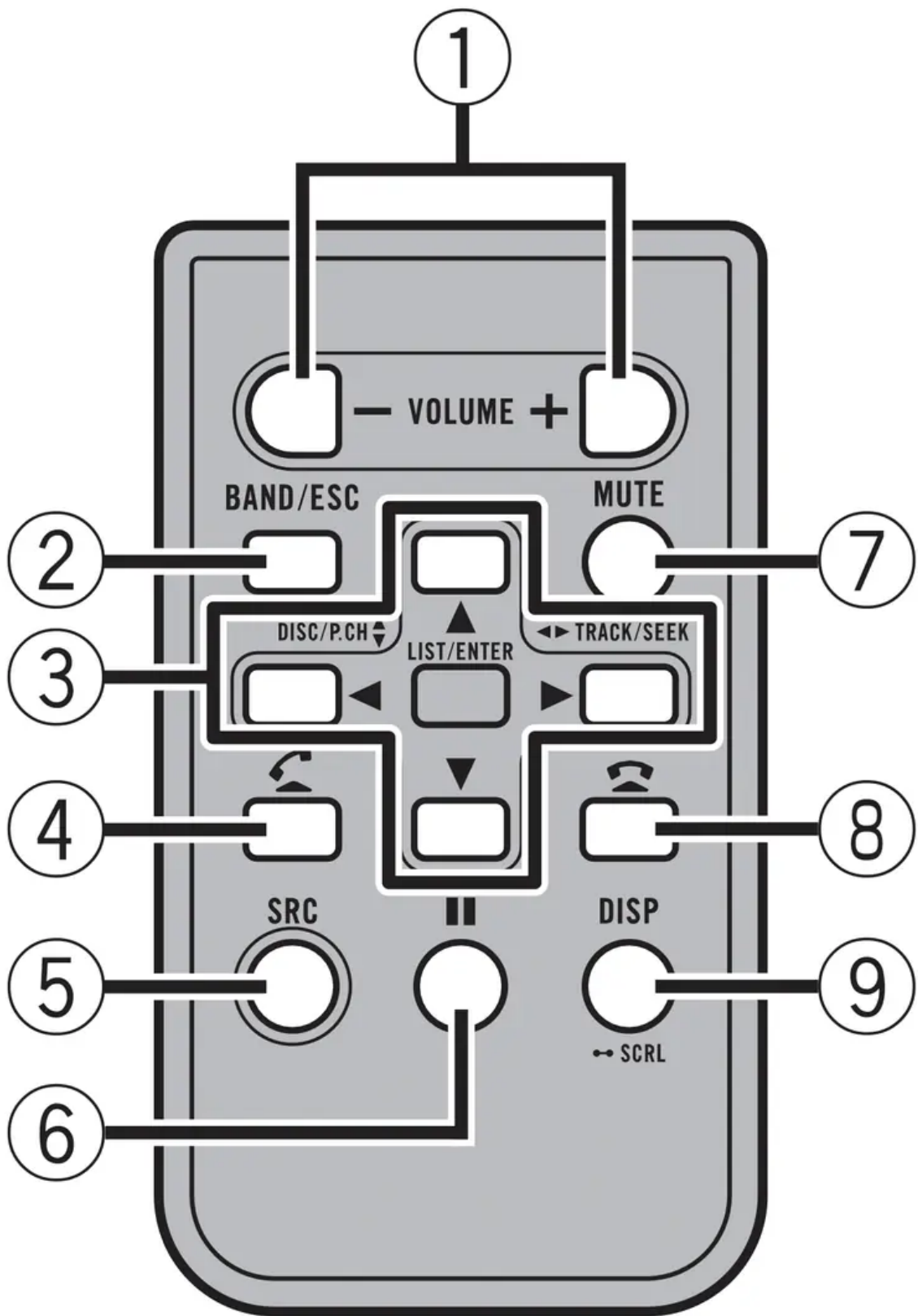

①	Volume (+/-)	
②	BAND/ESC	Press to select the tuner band when tuner is selected as a source.
③	◀▶	Press to select the previous or next track/file. Press and hold to perform fast reverse or fast forward. Press to perform seek tuning (Radio).
	▲▼	Press to select the next or previous folder. Press to select a preset channel (Radio).
④	☎	Press to answer a call.
⑤	SRC	Press to switch the sources.
⑥	⏸	Press to pause or resume playback.
⑦	MUTE	
⑧	📞	Press to end a call.
⑨	DISP	Press to switch the display on/off.

340EX / 240EX

The remote control is sold separately.

Basic operation

Resetting the microprocessor

CAUTION

- Pressing the RESET button resets settings and recorded contents to the factory settings.
 - Do not perform this operation when a device is connected to this product.
 - Some of the settings and recorded contents will not be reset.
- The microprocessor must be reset under the following conditions:
 - Prior to using this product for the first time after installation.
 - If this product fails to operate properly.
 - If there appears to be problems with the operation of the system.

1. Turn the ignition switch OFF.
2. Press RESET with a pen tip or other pointed tools.
Settings and recorded contents are reset to the factory settings.

Preparing the remote control

342EX / 341EX / 241EX

Remove the insulation sheet before use.

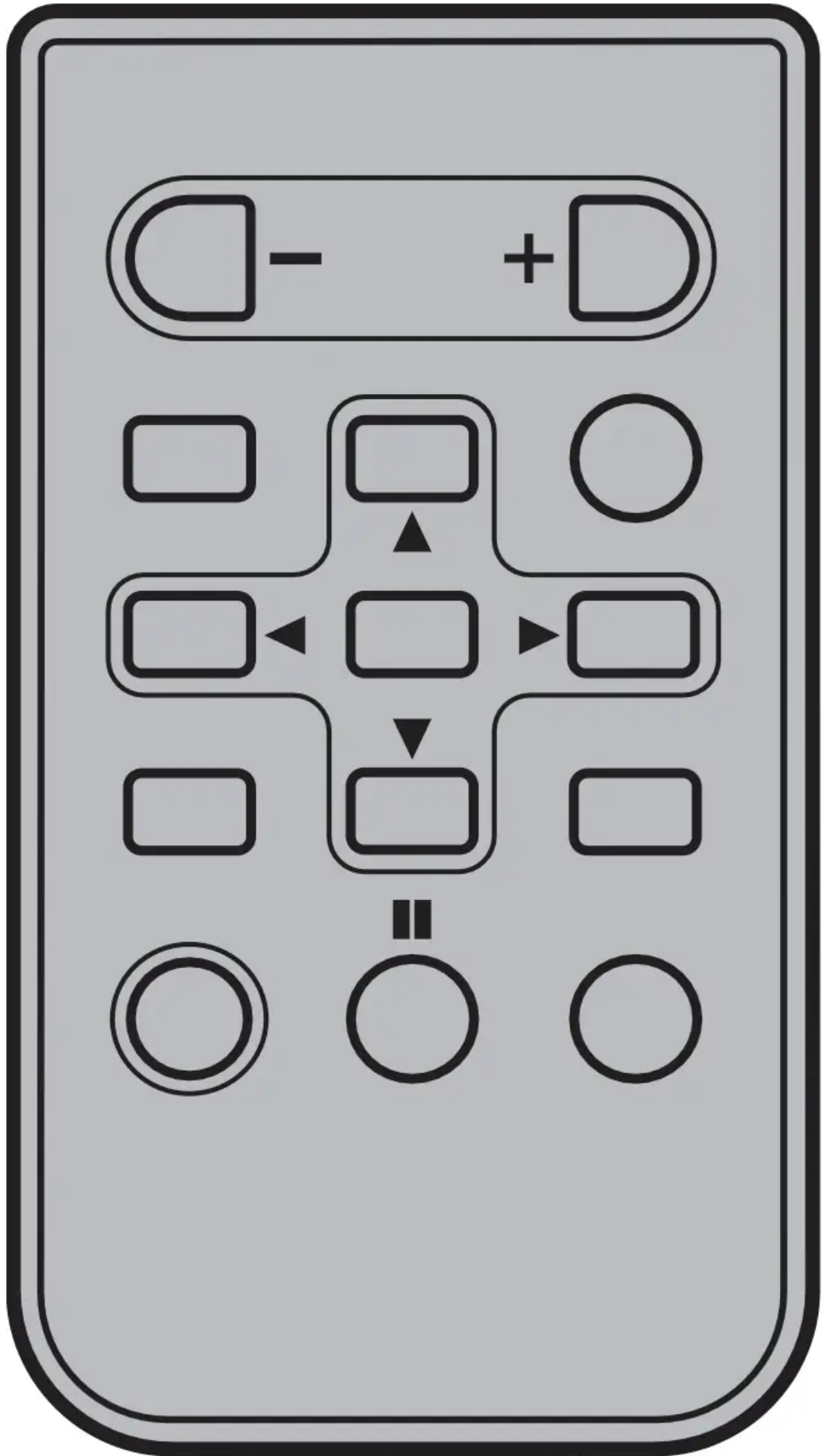

How to replace the battery

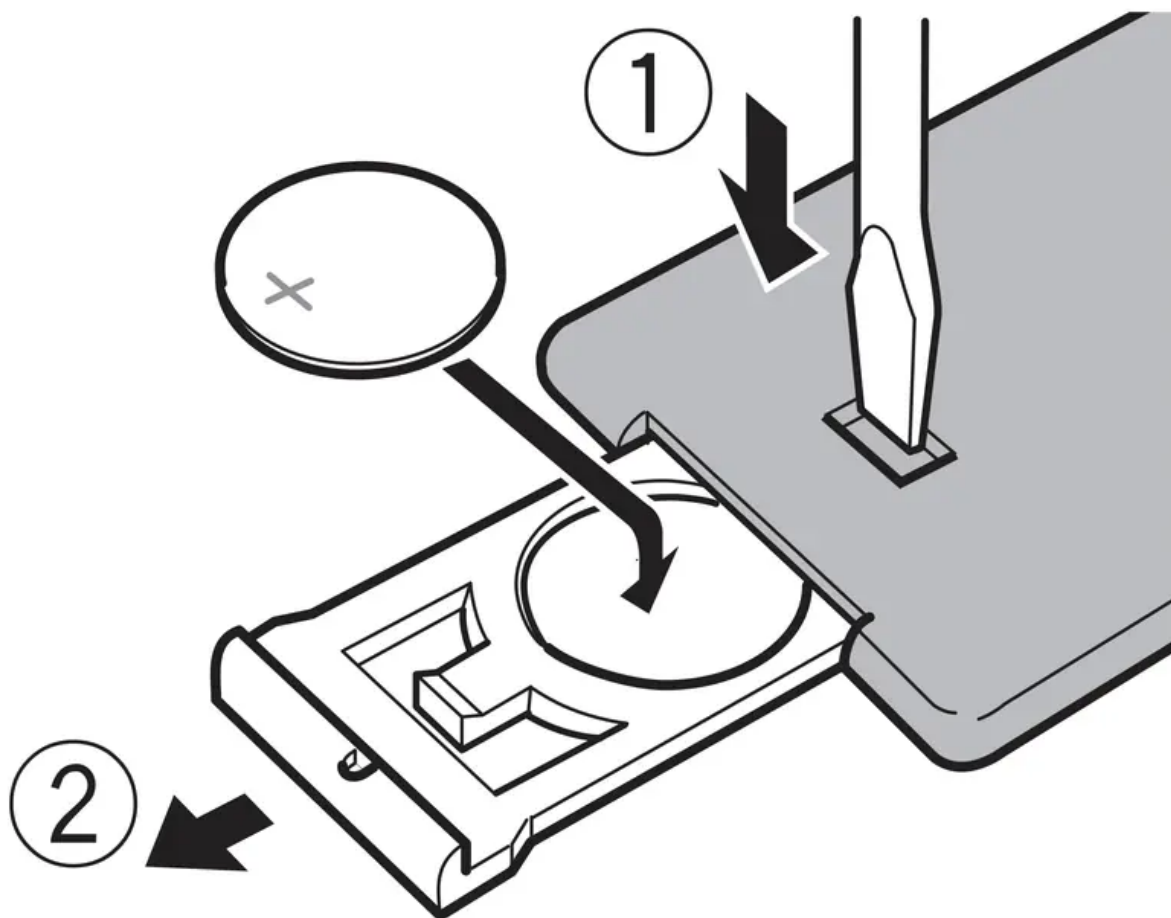

Insert the CR2025 (3 V) battery with the plus (+) and minus (-) poles orientated properly.

WARNING: Batteries (battery pack or batteries installed) must not be exposed to excessive heat such as sunshine, fire or the like.

CAUTION

- Remove the battery if the remote control is not used for a month or longer.
- There is a danger of explosion if the battery is incorrectly replaced. Replace only with the same or equivalent type.
- Do not expose a battery to high or low extreme temperatures during use, storage or transportation.
- Do not dispose of a battery into fire or a hot oven, or crush mechanically or cut a battery, that can result in an explosion.
- Do not handle the battery with metallic tools.
- Do not store the battery with metallic objects.
- If the battery leaks, wipe the remote control completely clean and install a new battery.

- When disposing of used batteries, please comply with governmental regulations or environmental public institution's rules that apply in your country/area.
- "Perchlorate Material – special handling may apply."

Using the remote control

Point the remote control in the direction of the front panel to operate.

NOTE: The remote control may not function properly in direct sunlight.

Important

- Do not store the remote control in high temperatures or direct sunlight.
- Do not let the remote control fall onto the floor, where it may become jammed under the brake or gas pedal.

Using the touch panel

You can operate this product by touching the keys on the screen directly with your fingers.

NOTE: To protect the LCD screen from damage, be sure to touch the screen only with your finger gently.

Common touch panel keys



: Returns to the previous screen.



: Close the screen.

Operating list screens

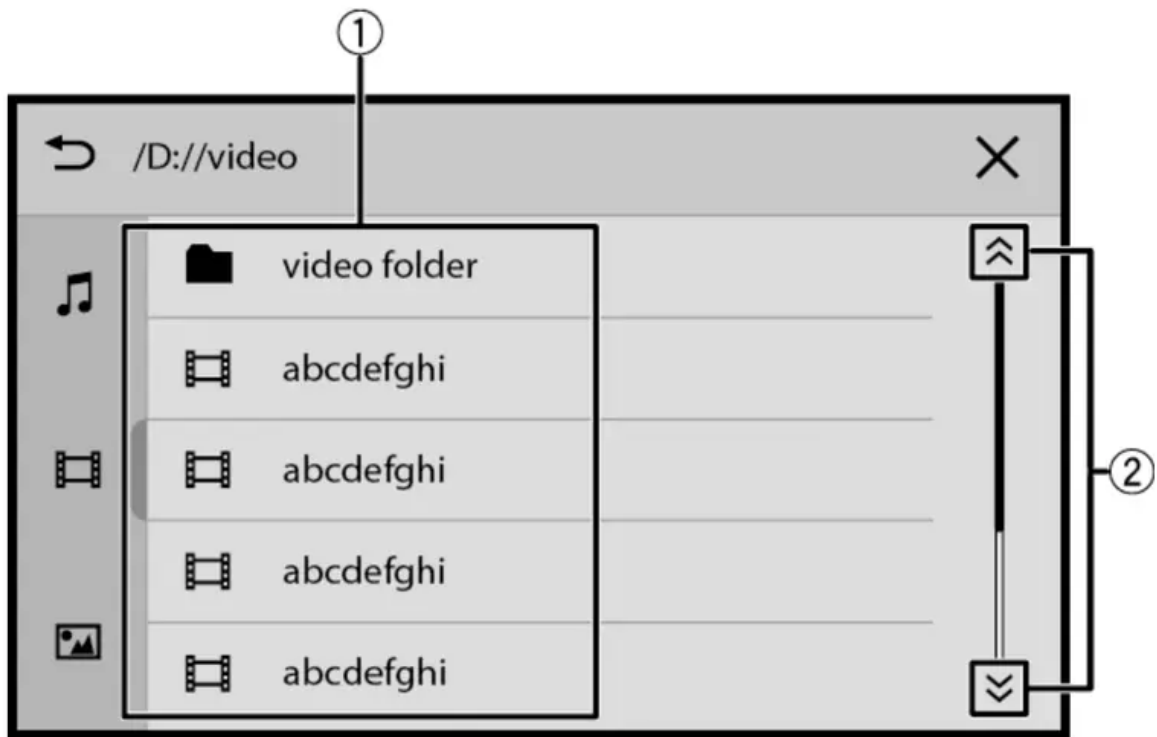

1. Touching an item on the list allows you to narrow down the options and proceed to the next operation.
2. Touch to view any hidden items.

Operating the time bar

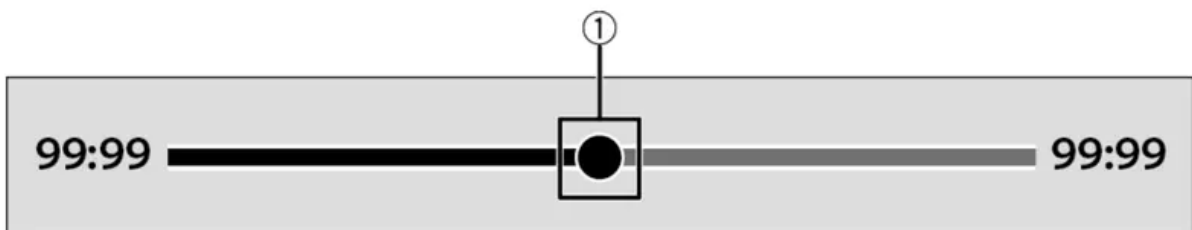

1. You can change the playback point by touching in the bar.



Top menu screen



①	Source icons TIP You can display the hidden source icon(s) by swiping left or right on the screen. (some models)
	Settings (page 35)

Bluetooth®

Bluetooth connection

1. Turn on the Bluetooth function on the device.
2. Press .
Press .
3. Touch [Phone] or [Bluetooth Audio].
The unit name is shown in the display.
4. Select the unit name shown in the mobile device display.
5. Perform the pairing operation by the mobile device and this unit.
After the device is successfully registered, a Bluetooth connection is established by the system.

TIP: To disconnect the connection, touch the connected device name on the top of the phone number input screen (page 16).

NOTE: You need to disconnect the Bluetooth connection with connected mobile device to connect another mobile device.









Hands-free phoning

To use this function you need to connect your cellular phone to this product via Bluetooth in advance (page 15).

CAUTION: For your safety, avoid talking on the phone as much as possible while driving.

Making a phone call



1. Press .
2. Touch [Phone].
The phone menu screen appears.
3. Touch one of the call icons on the phone menu screen.

	Synchronizes the contacts and call history on your phone manually.
	Using phone book Select a contact from the phone book. Touch the contact on the list. TIP You can use initial search by touching the character at the right side of the phone book screen.
	Using call history Make a phone call by touching the one of the icon from the received call  , dialed call  , or missed call  .
	Direct phone number input Touch the number keys to enter the phone number then touch  to make a call. TIP You can redial to the last dialed number by touching  without entering the number.

To end the call

1. Touch .

Receiving a phone call

1. Touch  to answer the call.
Touch  to end the call.

Voice recognition function (for iPhone)

By connecting your iPhone to this product, you can use the voice recognition function on this product.

Switching the audio output

You can switch the audio output between this unit and the connected mobile device.

1.



Touch  when calling.

The audio output switches each time by touching the icon.



TIP: Touch  to mute or unmute the connected microphone.

Notes for hands-free phoning

• General notes

- Connection to all cellular phones featuring Bluetooth wireless technology is not guaranteed.
- The line-of-sight distance between this product and your cellular phone must be 10 meters or less when sending and receiving voice and data via Bluetooth technology.
- With some cellular phones, the ring sound may not be output from the speakers.
- If private mode is selected on the cellular phone, hands-free phoning may be disabled.

• Registration and connection

- Cellular phone operations vary depending on the type of cellular phone. Refer to the instruction manual that came with your cellular phone for detailed instructions.
- When phone book transfer does not work, disconnect your phone and then perform pairing again from your phone to this product.

• Making and receiving calls

- You may hear a noise in the following situations:
 - When you answer the phone using the button on the phone.
 - When the person on the other end of the line hangs up the phone.
- If the person on the other end of the line cannot hear the conversation due to an echo, decrease the volume level for hands-free phoning.
- With some cellular phones, even after you press the accept button on the cellular phone when a call comes in, hands-free phoning may not be performed.

- The registered name in the phone book is displayed if the phonebook is transferred to this unit.
- **The received call and dialed number histories**
 - You cannot make a call to the entry of an unknown user (no phone number) in the received call history.
- **Phone book transfers**
 - If there are more than 1 000 phone book entries on your cellular phone, not all entries may download completely.
 - Depending on the phone, this product may not display the phone book correctly.
 - If the phone book in the phone contains image data, the phone book may not be transferred correctly.
 - Depending on the cellular phone, phone book transfer may not be available.

Bluetooth audio

Before using the Bluetooth audio player, register and connect the device to this product (page 15).







NOTES

- Depending on the Bluetooth audio player connected to this product, the available operations with this product may be limited to the following two levels:
 - A2DP (Advanced Audio Distribution Profile): Only playing back songs on your audio player is possible.
 - A2DP and AVRCP (Audio/Video Remote Control Profile): Playing back, pausing, selecting songs, etc., are possible.
- Depending on the Bluetooth device connected to this product, the available operations with this product may be limited or differ from the descriptions in this manual.
- While you are listening to songs on your Bluetooth device, refrain from operating the phone function as much as possible. If you try operating, the signal may cause noise for song playback.
- When you are talking on the Bluetooth device connected to this product via Bluetooth, it may pause playback.

1.  .

2. Touch [Bluetooth Audio].
The Bluetooth audio playback screen appears.

Basic operation

	Switches between playback and pause.
	 Skips files forward or backward.
	 Performs fast forward or fast reverse.
	Sets a repeat play range.
	Plays files in random order.

AV source

Supported AV source

You can play or use the following sources with this product.

- Radio
- CD*
- ROM (compressed audio or video files on discs)*
- DVD-Video*
- USB

The following sources can be played back or used by connecting an auxiliary device.

- iPhone
- Bluetooth audio
- AUX

* AVH-241EX, AVH-240EX

Selecting a source

1.  .
Press

2. Touch the source icon.











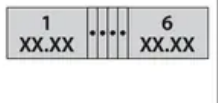

TIP: You can display the hidden source icon(s) by swiping left or right on the screen. (some models)

Radio

Starting procedure

1. Press .
2. Touch [Radio].
The Radio screen appears.

Basic operation

	 <p>Recalls the preset channel stored to a key from memory.</p>
	<p>Stores the current broadcast frequency to a key.</p>
	<p>Selects the FM1, FM2, FM3, AM1 or AM2 band.</p>
	 <p>Automatically stores the six strongest broadcast frequencies.</p> <p>NOTES</p> <ul style="list-style-type: none"> • Storing broadcast frequencies with BSM may replace those you have already saved. • Previously stored broadcast frequencies may remain stored if the number of frequencies stored has not reached the limit.
	 <p>Manual tuning</p>
	 <p>Seek tuning Skips to the nearest station from the current frequency.</p>
	<p>Tunes into only radio stations with sufficiently strong signals.</p> <p>NOTE Only available with the stations with the strongest signals when [Local] is set to on.</p>
	<p>Switches to display or hide the radio station name.</p>

NOTE: Some functions are available only when you receive the FM band.

Disc

AVH - 241EX / 240EX

Inserting and ejecting a disc

You can play a normal music CD, Video-CD, or DVD-Video using the built-in drive of this product.



CAUTION: Do not insert anything other than a disc into the disc-loading slot.

Inserting a disc

1. Insert a disc into the disc-loading slot.
The source changes and then playback will start.







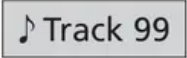

NOTE: If the disc is already set, select [Disc] as the playing source.

Ejecting a disc

1. Press .











Basic operation















Audio source

	Track number indicator
	Switches between playback and pause.
	 Skips files forward or backward.
	 Performs fast forward or fast reverse.
	Sets a repeat play for the current disc/the current track.
	Plays or does not play tracks in random order.
	Selects a track from the list. Touch a track on the list to play back.

Video source

CAUTION: For safety reasons, video images cannot be viewed while your vehicle is in motion. To view video images, stop in a safe place and apply the parking brake.

 	<p>Switches between playback and pause.</p>
 	<p>Skips files/chapters forward or backward.</p>
 	<p>Performs fast forward or fast reverse.</p>
	<p>Stops playback.</p>
 	<p>Displays the DVD menu.</p> <p>NOTE This function may not work properly with some DVD disc content. In that case, use touch panel keys to operate the DVD menu.</p>
	<p>Sets a repeat play for all files/the current chapter/the current title.</p>
	<p>Switches screen display mode.</p>

	<p>Switches the audio/subtitle language.</p> <p>NOTE This function is available for DVD-Video.</p>
	<p>Displays the hidden function bar.</p>
	<p>Searches for the part you want to play. Select search target, input the desired number then touch .</p> <p>TIP To cancel an input number, touch [C].</p>
	<p>Selects the audio output.</p> <p>NOTE This function is available for Video-CDs and DVDs recorded with LPCM audio.</p>
	<p>Changes the viewing angle (Multi-angle). This function is available for DVDs featuring multi-angle recordings.</p>
	<p>Resumes playback (Bookmark). This function is available for DVD-Video. You can memorize one point as a Bookmark for a disc. To clear the bookmark on the disc, touch and hold this key.</p>
	<p>Returns and begins playback from the specified point. This function is available for DVD-Video.</p>
	<p>Displays the DVD menu keypad. If items on the DVD menu appear, the touch panel keys may overlay them. If so, select an item using these touch panel keys. Touch , , , or  to select the menu item then touch .</p> <p>NOTE The way to display the menu differs depending on the disc.</p> <p>TIP If you touch , you can operate the DVD menu directly.</p>

Compressed files

Inserting and ejecting media

You can play compressed audio, compressed video, or still image files stored in a disc or an external storage device.

CAUTION: Do not insert anything other than a disc into the disc-loading slot.

Inserting a disc

AVH-241EX / AVH-240EX

1. Insert a disc into the disc-loading slot.
The source changes and then playback will start.

NOTE: If the disc is already set, select [Disc] as the playing source.

Ejecting a disc

AVH-241EX / AVH-240EX

1. Press .

Plugging a USB storage device

DMH-342EX / DMH-341EX / DMH-340EX

1. Pull out the plug from the USB port of the USB cable.
2. Plug a USB storage device into the USB cable.

DMH-241EX / DMH-240EX / AVH-241EX / AVH-240EX

1. Open the USB port cover.
2. Plug in the USB storage device using an appropriate cable.

CAUTION: Use a USB cable (sold separately) to connect the USB device as any device connected directly to the unit will protrude out from the unit, which could be dangerous.

NOTES

- This product may not achieve optimum performance with some USB storage devices.
- Connection via a USB hub is not possible.
- A USB cable is required for connection.*
* DMH-342EX, DMH-341EX, DMH-340EX

Unplugging a USB storage device

1. Pull out the USB storage device from the USB cable.

NOTES

- Check that no data is being accessed before pulling out the USB storage device.
- Turn off (ACC OFF) the ignition switch before unplugging the USB storage device.

Starting procedure

For Disc

AVH-241EX / AVH-240EX

1. Insert the disc.

TIP: If the disc is already set, select [Disc] as the playing source.













For USB

1. Plug the USB storage device into the USB cable.

TIP: You can also start this source by pressing  then touching [USB].

Basic operation















Audio source

	Switches between playback and pause.
	<p> Skips files forward or backward.</p>
	Performs fast forward or fast reverse.
	Sets a repeat play range for all files/the current folder/the current file.
	Plays files or does not play in random order.
	<p>Selects a file from the list. Touch a file on the list to playback.</p> <p>TIPS</p> <ul style="list-style-type: none"> • Touching a folder on the list shows its contents. You can play a file on the list by touching it. • You can switch the following media file types. <ul style="list-style-type: none"> - : Compressed audio files - : Compressed video files - : Image files <p>NOTE</p> <p>The files and folders displayed depend on the media. Some files and folders may not be displayed if there are 1 300 files or more in the media, if the files contain additional information, or if many folders are registered.</p>
	Displays the hidden function bar. (only for disc)
	Selects the previous folder or the next folder. (only for disc)
	Switches the current music information display. (only for disc)

Video source











CAUTION: For safety reasons, video images cannot be viewed while your vehicle is in motion. To view video images, stop in a safe place and apply the parking brake.

	Switches between playback and pause.
---	---

	Stops playback then displays playlist.
	 Skips files forward or backward.
	 Performs fast forward or fast reverse. (only for USB)
	Performs fast forward or fast reverse. (only for disc)
	Sets a repeat play range for all files/the current folder/the current file.
	<p>Selects a file from the list. Touch a file on the list to playback.</p> <p>TIPS</p> <ul style="list-style-type: none"> • Touching a folder on the list shows its contents. You can play a file on the list by touching it. • You can switch the following media file types. <ul style="list-style-type: none"> - : Compressed audio files - : Compressed video files - : Image files <p>NOTE</p> <p>The files and folders displayed depend on the media. Some files and folders may not be displayed if there are 1 300 files or more in the media, if the files contain additional information, or if many folders are registered.</p>
	Displays the hidden function bar. (only for USB)
	Selects the previous folder or the next folder. (only for disc)
	Switches screen display mode.
	Switches the audio/subtitle language. (only some files)

Still image source

	Switches between playback and pause.
---	---

	Stops playback then displays playlist.
	Skips files forward or backward.
	Rotates the displayed picture 90° counterclockwise.
	Sets a repeat play range for all files/the current folder.
	<p>Selects a file from the list. Touch a file on the list to playback.</p> <p>TIPS</p> <ul style="list-style-type: none"> • Touching a folder on the list shows its contents. You can play a file on the list by touching it. • You can switch the following media file types. <ul style="list-style-type: none"> – : Compressed audio files – : Compressed video files – : Image files <p>NOTE</p> <p>The files and folders displayed depend on the media. Some files and folders may not be displayed if there are 1 300 files or more in the media, if the files contain additional information, or if many folders are registered.</p>
	Displays the hidden function bar.
	Switches screen display mode.

iPhone

NOTE: iPhone may be referred to as iPod in this manual.

Starting procedure

When connecting an iPhone to this product, the settings are automatically configured according to the device to be connected. For details of the compatibility, refer to Compatible iPhone models (page 49).







NOTE: [iPhone USB Settings] is set to [iPod] (page 35).

1. Connect your iPhone via USB.
Playback is automatically performed.

TIP: You can also start this source by pressing  then touching [iPod].

NOTE: For USB connection, refer to the Installation Manual.

Basic operation

	Switches between playback and pause.
	 Skips files forward or backward.
	 Performs fast forward or fast reverse.
	Sets a repeat play range for the selected list or album/the current file.
	Plays songs within the selected list/album randomly.
	Selects a song from the list. Touch the category then the title of the list to playback of the selected list. TIP You can switch the song list by selecting the character in the initial bar while the initial bar is displayed. NOTE Only 1 300 songs in the iPhone are available in the list if the iPhone has more than 1 300 songs. The number of songs available may be less than 1 300, due to the additional information included in the songs. Available songs depend on the iPhone.

NOTE: Depending on the generation or version of the iPhone, some functions may not be available.

WebLink™

You can operate WebLink compatible applications with finger gestures such as tapping, dragging, scrolling, or flicking on the screen of this product.

NOTES

- The supported finger gestures may vary depending on the WebLink compatible application.
- To use WebLink, you must first install the WebLink Host app on the iPhone or smartphone.
- Be sure to read Using app-based connected content (page 49) before you perform this operation.

- Copyright protected files such as DRM cannot be played.

WARNING: Certain uses of the iPhone or smartphone may not be legal while driving in your jurisdiction, so you must be aware of and obey any such restrictions. If in doubt as to a particular function, only perform it while the car is parked. No feature should be used unless it is safe to do so under the driving conditions you are experiencing.

Using WebLink

Important

- Pioneer is not responsible for content or functions accessed via WebLink, which are the responsibility of the application and content providers.
- Availability of non-Pioneer content and services, including apps and connectivity, may change or discontinue without notice.
- When using WebLink with the Pioneer product, available content and functions will be limited while driving.
- WebLink allows access to applications other than those listed, subject to limitations while driving.

Starting procedure

For iPhone users

System requirement

iOS 13.4 or higher

NOTE: [iPhone USB Settings] is set to [WebLink] (page 35).

1. Unlock your iPhone and connect it to this product via USB.
WebLink is automatically launched.

TIP: You can also start this source by pressing  then touching [WebLink].

NOTE: For USB connection, refer to the Installation Manual.

For smartphone (Android™) users

System requirement

Android 7.0 or higher

NOTE: The video playback capability depends on the connected Android device.

1. Unlock your smartphone and connect it to this product via USB.
WebLink is automatically launched.

TIP: You can also start this source by pressing  then touching [WebLink].

NOTES

- For USB connection, refer to the Installation Manual.
- Make sure that file transfer mode for USB connection is enabled on your smartphone if WebLink does not start automatically.

Basic operation

Touch the desired application icon after the WebLink app is launched. The desired application is launched, and the application operation screen appears.



: Displays the main menu of the WebLink source screen.

TIPS

- If you connect your device to this product while a WebLink compatible application is already running, the application operation screen will appear on this product.
- Check the Bluetooth connection between the mobile device and this unit if there is no sound output from this unit (page 15).

AUX

You can display the video image output by the device connected to AUX input.

CAUTION: For safety reasons, video images cannot be viewed while your vehicle is in motion. To view video images, stop in a safe place and apply the parking brake.

NOTE: A Mini-jack AV cable (sold separately) is required for connection. For details, refer to the Installation Manual.

Starting procedure

1. Press .
2. Touch [AUX].
The AUX screen appears.

Camera View

You can display the video image output by the device connected to camera input. For details, refer to the Installation Manual.

CAUTION: Rear camera function is only as an assistant tool for driving. It cannot replace the drivers' attentions and judgement.

Rear view camera

This product features a function that automatically switches to the full-screen image of the rear view camera installed on your vehicle when the shift lever is in the REVERSE (R) position.



Camera for Camera View mode

Camera View can be displayed at all times. Note that with this setting, the camera image is not resized to fit, and that a portion of what is seen by the camera is not viewable.

CAUTION: Pioneer recommends the use of a camera which outputs mirror reversed images, otherwise the screen image may appear reversed.

- Immediately verify whether the display changes to the rear view camera image when the shift lever is moved to REVERSE (R) from another position.





Starting procedure

1. Press .
AVH-241EX, AVH-240EX
Press  then swipe left on the screen.
2. Touch [Camera View] for connected camera view.
The video image is displayed on the screen.

Settings

You can adjust various settings in the main menu.

Displaying the setting screen

1. Press .
2. Touch .
3. Touch one of the following categories, then select the options.
 -  : System Settings (page 35)
 -  : Theme Settings (page 38)
 -  : Audio Settings (page 38)

NOTE: Some settings are available only when you stop your vehicle in a safe place and apply the parking brake.

System Settings

Menu Item	Description
[System Language]	Select the system language. NOTES <ul style="list-style-type: none"> • If the embedded language and the selected language setting are not the same, the text information may not display properly. • Some characters may not be displayed properly.
[iPhone USB Settings] [iPod], [WebLink]	Select the desired function to use when the iPhone is connected via USB.
[Date & Time]	Set the date and time by touching ▲ or ▼. TIPS <ul style="list-style-type: none"> • You can change the time display format to [AM], [PM] or [24H]. • You can change the order of the month/date display format.
[Back Camera Input]	Select to enable or disable camera view or rear view camera function.
[Dimmer Trigger] [Auto] [Day] [Night]	Select the screen brightness automatically according to the vehicle's lighting switch or select the brightness manually by [Day] or [Night].
[Dimmer Value]	Adjust the display brightness in the day time or night time.

Menu Item	Description
[Picture Adjustment] [Brightness] [Contrast] [Color] [Hue] [Sharpness]	Adjust the image quality while playing Video-CD *1, DVD-Video *1, disc *1 / USB video. TIP Adjust the image quality of the camera image by touching anywhere on the screens while in Camera View mode.
[Restore Settings]	Touch [OK] to restore the settings to the default settings.  CAUTION Do not turn off the engine while restoring the settings. NOTES <ul style="list-style-type: none"> • The source is turned off and the Bluetooth connection is disconnected before the process starts. • Before starting the restore process, disconnect any device that is connected to the USB port. Otherwise, some settings may not be restored correctly.
[System Information]	Displaying the firmware version.
[License]	Displaying the open source license.
[Touch panel calibration]*2	Adjust the response positions of the touch panel screen if the touch panel keys on the screen deviate from the actual positions. <ol style="list-style-type: none"> 1 Touch four corners of the [+] mark displayed on the screen. 2 Touch the center of the [+] mark displayed on the screen. 3 Touch [OK]. The adjustment results are saved. NOTES <ul style="list-style-type: none"> • Do not use sharp pointed tools such as ballpoint or mechanical pens. They may damage the screen. • Do not turn off the engine while saving the adjusted position data.

Menu Item	Description
[TV Aspect]*1	<p>Set the aspect ratio suitable for your rear display 16:9 (wide screen display) or 4:3 (regular display). (We recommend use of this function only when you want to fit the aspect ratio to the rear display.)</p> <p>NOTES</p> <ul style="list-style-type: none"> • When using a regular display, select either [Letter Box] or [Pan Scan]. Selecting [16:9] may result in an unnatural image. • If you select the TV aspect ratio, this product's display will change to the same setting. • When playing discs that do not have a panscan system, the disc is played back with [Letter Box] even if you select the [Pan Scan] setting. Confirm whether the disc package bears the  mark. • The TV aspect ratio cannot be changed for some discs. For details, refer to the disc's instructions.
[16:9]	Displays the wide screen image (16:9) as it is.
[Letter Box]	Makes the image in the shape of a letterbox with black bands on the top and bottom of the screen.
[Pan Scan]	Cuts the image short on the right and left sides of the screen.
[Parental]*1	<p>Set restrictions so that children cannot watch violent or adult-oriented scenes.</p> <p>The first time you select [Parental], set a password. Next, enter the password you set and set the parental lock level. The lower the level is set, the tighter the restriction is applied.</p> <p>NOTES</p> <ul style="list-style-type: none"> • We recommend keeping a record of the password in case you forget it. • The parental lock level is recorded on the disc. You can confirm it by looking at the disc package, the included booklet, or the disc itself. You cannot use parental lock with discs that do not feature a recorded parental lock level. • With some discs, parental lock operates to skip certain scenes only, after which normal playback resumes. For details, refer to the disc's instructions.

*1 AVH-241EX, AVH-240EX

*2 DMH-241EX, DMH-240EX, AVH-241EX, AVH-240EX

Theme Settings

NOTE: This setting is not available when the video/image file is in playback.

Menu Item	Description
[Background]	Select the wall paper from the preset items in this product.
[Illumination]*	Select an illumination color from the preset list.

* DMH-342EX, DMH-341EX, DMH-340EX

Audio Settings

Menu Item	Description
[EQ] [Flat] [Super Bass] [Powerful] [Natural] [Vocal] [Custom]	Select or customize the equalizer curve.
[Fader/Balance]	Touch ▲ or ▼ to adjust the front/rear speaker balance. Set front/rear speaker balance to 0 when using a dual speaker system. Touch ◀ or ▶ to adjust the left/right speaker balance. TIP You can also set the value by touching the desired place on the displayed table.
[Volume]	Adjust the volume level by touching [+]/[-].
[Main Volume]	Other than Bluetooth audio
[Talking Volume]	Hands-free phone
[TA Volume]	Traffic announce
[Bluetooth Audio Volume]	Bluetooth audio
[Loudness] [Off] [Low] [Mid] [High]	Compensates for deficiencies in the low-frequency and high-frequency ranges at low volume.
[Bass Boost]	Adjust the bass boost level.
[Cutoff] [Front HPF] [Rear HPF] [Subwoofer LPF]	Adjust each speaker cutoff frequency value.
[Beep Tone]	Select off to disable the beep sound when the button is pressed or the screen is touched.

Other functions

Setting the time and date

You can adjust the date and time from [Date & Time] in the [System Settings] menu (page 35).

Restoring this product to the default settings

You can restore settings or recorded content to the default settings from [Restore Settings] in the [System Settings] menu (page 36).

Firmware update

When the latest software is released on our website, you can update the software of this unit (page 6).

CAUTION

- The USB storage device for updating must contain only the correct update file.
 - Never turn this product off, disconnect the USB storage device while the firmware is being updated.
 - You can only update the firmware when the vehicle is stopped and the parking brake is engaged.
1. Download the firmware update files into your computer.
 2. Connect a blank (formatted) USB storage device to your computer then locate the correct update file and copy it onto the USB storage device.
 3. Connect the USB storage device to this product (page 24).
 4. Follow the on-screen instructions to finish updating the firmware.

NOTES

- This product will reset automatically after the firmware update is completed if the update is successful.
- If an error message appears on the screen, perform the above steps again.

Troubleshooting

If you have problems operating this product, refer to this section. The most common problems are listed below, along with likely causes and solutions. If a solution to your problem cannot be found here, contact your dealer or the nearest authorized Pioneer service facility.

Common problems

A black screen is displayed, and operation is not possible using the touch panel keys.

→ Power off mode is on.

- Press  to release the mode.

Problems with the AV screen

The screen is covered by a caution message and the video cannot be shown.

→ The parking brake lead is not connected or the parking brake is not applied.

- Connect the parking brake lead correctly, and apply the parking brake.

→ The parking brake interlock is activated.

- Park your vehicle in a safe place and apply the parking brake.

The audio or video skips.

→ This product is not firmly secured.

- Secure this product firmly.

No sounds are produced. The volume level will not rise.

→ Cables are not connected correctly.

- Connect the cables correctly.

iPhone cannot be operated.

→ The iPhone is frozen.

- Reconnect the iPhone with the USB interface cable for iPhone.
- Update the iPhone software version.

→ An error has occurred.

- Reconnect the iPhone with the USB interface cable for iPhone.
- Park your vehicle in a safe place, and then turn off the ignition switch (ACC OFF). Subsequently, turn the ignition switch to on (ACC ON) again.
- Update the iPhone software version.

→ Cables are not connected correctly.

- Connect the cables correctly.

Sound from the iPhone cannot be heard.

→ The audio output direction may switch automatically when the Bluetooth and USB connections are used at the same time.

- Use the iPhone to change the audio output direction.

No back camera image when the vehicle is in reverse.

→ The back camera input setting on the receiver is set to Off.

- Change the back camera setting to On in the settings menu. (Refer to the System Settings section of this manual to adjust.)

→ The camera input may be loose or not connected.

- Check the connection and make sure the male end of the camera is connected to the brown input on the back of the receiver. (Refer to the installation manual.)

→ The reverse lead on the receiver may not be connected to the proper wire at the reverse lamp.

- Check the connection and make sure that the violet/white lead of the receiver is connected to the lead whose voltage changes when the shift lever is put in reverse. (Refer to the installation manual).

Black screen displayed when the vehicle is in reverse, with no camera installed.

→ Back camera input is set to On.

- Turn the setting to Off in the settings menu. (Refer to the System Settings section of this manual to adjust.)

Problems with the phone screen

Dialing is impossible because the touch panel keys for dialing are inactive.

→ Your phone is out of range for service.

- Retry after re-entering the range for service.

Problems with Application screen

The screen is displayed, but operation does not work at all.

→ An error has occurred.

- Park your vehicle in a safe place, and then turn off the ignition switch (ACC OFF). Subsequently, turn the ignition switch to on (ACC ON) again.

The smartphone was not charged.

→ Charging stopped because the temperature of the smartphone rose due to prolonged use of the smartphone during charging.

- Disconnect the smartphone from the cable, and wait until the smartphone cools down.

→ More battery power was consumed than was gained from charging.

- This problem may be resolved by stopping any unnecessary services on the smartphone.

Error messages

When problems occur with this product, an error message appears on the display. Refer to the table below to identify the problem, then take the suggested corrective action. If the error persists, record the error message and contact your dealer or your nearest Pioneer service center.

Common

AMP Error

→ This product fails to operate or the speaker connection is incorrect; the protective circuit is activated.

- Check the speaker connection. If the message fails to disappear even after the engine is switched off/on, contact your dealer or an authorized Pioneer Service Station for assistance.

Disc

Load Failed

→ The disc is dirty.

- Clean the disc.

→ The disc is scratched.

- Replace the disc.

→ The disc is loaded upside down.

- Check that the disc is loaded correctly.

→ The disc format cannot be played back.

- Replace the disc.

→ The loaded disc is a type this product cannot play.

- Check what type of disc it is.

File Error

→ This type of file is not supported on this product.

- Select a file that can be played.

No Media Files

→ There is no playable file on the disc.

- Check that the files in the disc is compatible with this product.

Unplayable File

→ This type of file is not supported on this product.

- Select a file that can be played.

Audio Code Not Supported

→ This type of file is not supported on this product.

- Select a file that can be played.

USB storage device

HUB Error

- The connected USB hub is not supported by this product.
 - Directly connect the USB storage device to this product.

No Response

- This product cannot recognize the connected USB storage device.
 - Disconnect the device and replace it with another USB storage device.

Load Failed

- Failed to load the USB storage device.
 - Reconnect the USB storage device.
- Security for the connected USB storage device is enabled.
 - Follow the USB storage device instructions to disable security.
- This product cannot recognize the connected USB storage device.
 - Disconnect the device and replace it with another USB storage device.

Device Not Supported

- The connected USB storage device is not supported by this product.
 - Disconnect your device and replace it with a compatible USB storage device.

File Error

- This type of file is not supported on this product.
 - Select a file that can be played.

No Media Files

- There is no playable file in the USB storage device.
 - Check that the files in the USB storage device are compatible with this product.

Unplayable File

- This type of file is not supported on this product.
 - Select a file that can be played.

Audio Code Not Supported

- This type of file is not supported on this product.
 - Select a file that can be played.

iPhone

Load Failed

→ Failed to load the iPhone.

- Disconnect the connected iPhone and check the iPhone is working properly.

Device Not Supported

→ The connected iPhone is not supported by this product.

- Disconnect your device and replace it with a compatible iPhone.

No Media Files

→ There is no playable file in the iPhone.

- Check that the files in the iPhone are compatible with this product.

No Music Files

→ There is no playable file in the selected folder.

- Select a compatible file with this product in another folder.

Camera View & AUX

No Video Signal

→ There is no video signal input.

- Confirm whether the connection with the unit is established and there is an output from the external device.

Handling and care of discs

Some basic precautions are necessary when handling your discs.

Built-in drive and care

- Use only conventional, fully circular discs. Do not use shaped discs.
- Do not use cracked, chipped, warped, or otherwise damaged discs as they may damage the built-in drive.
- Use 12-cm discs. Do not use 8-cm discs or an adapter for 8-cm discs.
- When using discs that can be printed on label surfaces, check the instructions and the warnings of the discs. Depending on the discs, inserting and ejecting may not be possible. Using such discs may result in damage to this equipment.
- Do not attach labels, write on or apply chemicals to the surface of the discs.
- Do not attach commercially available labels or other materials to the discs.

- To clean a disc, wipe it with a soft cloth, moving outward from the center.
- Condensation may temporarily impair the built-in drive's performance.
- Playback of discs may not be possible because of disc characteristics, disc format, recorded application, playback environment, storage conditions and so on.
- Road shocks may interrupt disc playback.
- Read the precautions for discs before using them.

Ambient conditions for playing a disc

- At extremely high temperatures, a temperature cutout protects this product by switching it off automatically.
- Despite our careful design of the product, small scratches that do not affect actual operation may appear on the disc surface as a result of mechanical wear, ambient conditions for use or handling of the disc. This is not a sign of the malfunction of this product. Consider it to be normal wear and tear.

Warning

This content is compiled from multiple sources and is provided for reference purposes only. It may not be complete or fully applicable to all situations. If you are unable to resolve your issue, please contact the product manufacturer or an authorized service provider for official support.