

## Preparing

### Lifting and moving the TV

When moving or lifting the TV, read the following to prevent the TV from being scratched or damaged and for safe transportation regardless of its type and size.

- Before moving or lifting the TV, disconnect the power cord and all cables.
- When holding the TV, the screen should face away from you to avoid damage.



- Hold the side and bottom of the TV frame firmly. Make sure not to hold the transparent part, speaker, or speaker grill area.

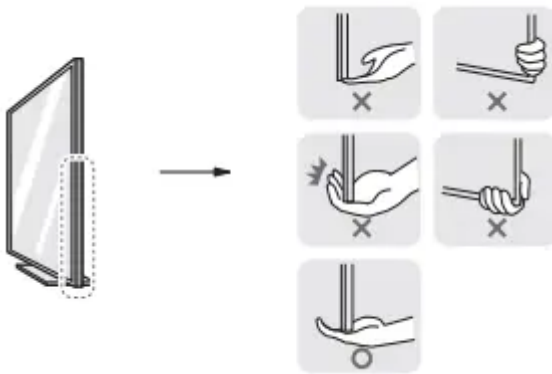

- Use at least two people to move a large TV.
- When transporting the TV by hand, hold the TV as shown in the following illustration.

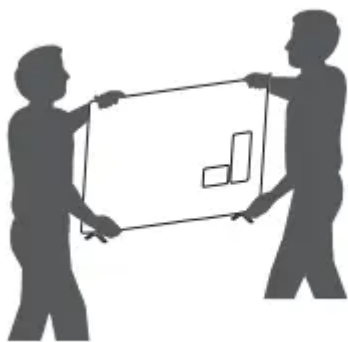

- When transporting the TV, do not expose the TV to jolts or excessive vibration.
- When transporting the TV, keep the TV upright, never turn the TV on its side or tilt towards the left or right.
- When handling the TV, be careful not to damage the protruding buttons.

**CAUTION:**

- Avoid touching the screen at all times, as this may result in damage to the screen.
- Do not place the product on the floor with its front facing down without padding. Failure to do so may result in damage to the screen.
- When attaching the stand to the TV set, place the screen facing down on a cushioned table or flat surface to protect the screen from scratches.

**Mounting on the Table**

1 Lift and tilt the TV into its upright position on a table.

- Leave a 10cm (minimum) space from the wall for proper ventilation.

2 Connect the power cord to a wall outlet.

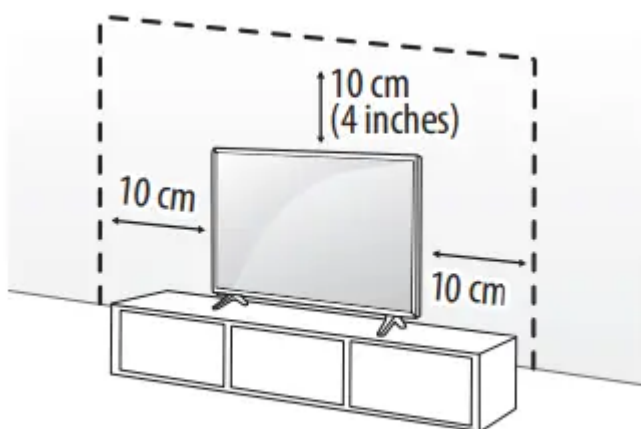

(Depending upon model)

## CAUTION:

- Do not apply foreign substances (oils, lubricants, etc.) to the screw parts when assembling the product. (Doing so may damage the product.)
- If you install the TV on a stand, you need to take actions to prevent the product from overturning. Otherwise, the product may fall over, which may cause injury.
- Do not use any unapproved items to ensure the safety and product life span.
- Any damage or injuries caused by using unapproved items are not covered by the warranty.
- Make sure that the screws are inserted correctly and fastened securely. (If they are not fastened securely enough, the TV may tilt forward after being installed.)
- Do not fasten the screws with excessive force otherwise they may strip and become loose.

## Securing TV to the Wall

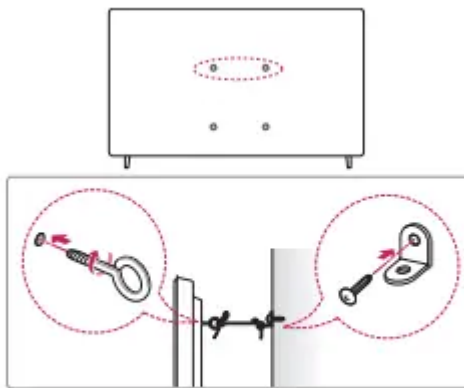

(Depending upon model)

1 Insert and tighten the eye-bolts, or TV brackets and bolts on the back of the TV.

- If there are bolts inserted at the eye-bolts position, remove the bolts first.

2 Mount the wall brackets with the bolts to the wall. Match the location of the wall bracket and the eye-bolts on the rear of the TV.

3 Connect the eye-bolts and wall brackets tightly with a sturdy rope. Make sure to keep the rope horizontal with the flat surface.

- Use a platform or cabinet that is strong and large enough to support the TV securely.
- Brackets, bolts and ropes are not provided. You can obtain additional accessories from your local dealer.

## Mounting to the Wall

Attach an optional wall mount bracket at the rear of the TV carefully and install the wall mount bracket on a solid wall perpendicular to the floor. When you attach the TV to other building materials, please contact qualified personnel. LG recommends that wall mounting be performed by a qualified professional installer. We recommend the use of LG's wall mount bracket. LG's wall mount bracket is easy to move with cables connected. When you do not use LG's wall mount bracket, please use a wall mount bracket where the device is adequately secured to the wall with enough space to allow connectivity to external devices. It is advised to connect all the cables before installing fixed wall mounts.

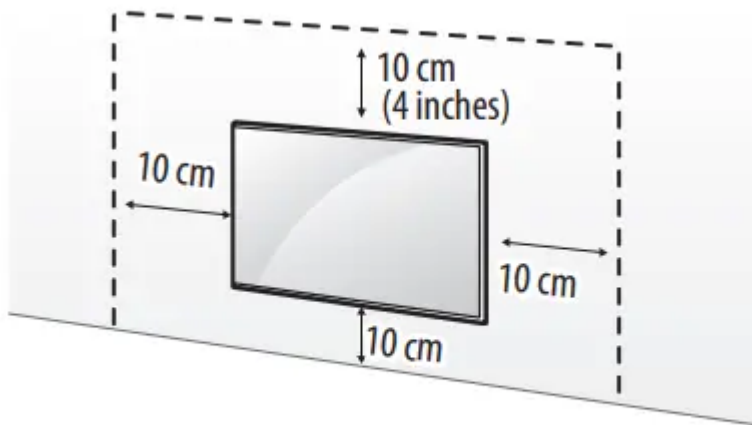

(Depending upon model)

### CAUTION:

- Remove the stand before installing the TV on a wall mount by performing the stand attachment in reverse.
- For more information of screws and wall mount bracket, refer to the Separate purchase.
- If you intend to mount the product to a wall, attach VESA standard mounting interface (optional parts) to the back of the product. When you install the set to use the wall mounting bracket (optional parts), fix it carefully so as not to drop.
- When mounting a TV on the wall, make sure not to install the TV by hanging the power and signal cables on the back of the TV.
- Do not install this product on a wall if it could be exposed to oil or oil mist. This may damage the product and cause it to fall.
- When installing the Full Contact Wall Mount, the TV may not be contacted firmly against the wall due to some wall conditions.

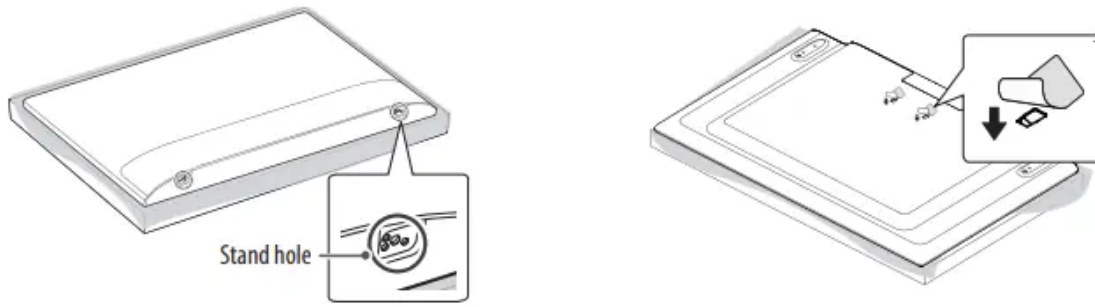

(Depending on model)

## Wall Mounting Bracket

(Depending upon model!)

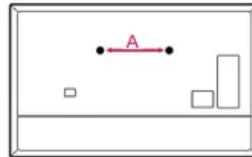

Model	43/50UP77* 43/50UP80*	55/60/65UP77* 55/60/65UP80*
Screws distance (A) (mm)	200	300
Standard screw	M6	M6
Number of screws	2	2
Wall mount bracket (Optional)	WB21LMB	WB21LMB

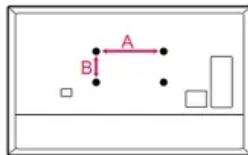

Model	43/50UP71* 43/50UP75* 43/50UP77* 43/50UP80*	55UP71* 55UP75* 55UP77* 55UP80*	65UP71* 65UP75* 60/65UP77* 60/65UP80*	70/75UP77* 70/75UP80*	70/75UP70* 70/75UP71* 70/75UP75* 82/86UP87*
VESA (A x B) (mm)	200 x 200	300 x 300	300 x 300	400 x 400	600 x 400
Standard screw	M6	M6	M6	M6	M8
Number of screws	4	4	4	4	4
Wall mount bracket	LSW240B MSW240	OLW480B MSW240	OLW480B	LSW440B	LSW640B

## Antenna/Cable

Connect an antenna, cable, or cable box to watch TV while referring to the following. The illustrations may differ from the actual items and an RF cable is optional.

- Make sure not to bend the copper wire of the RF cable.

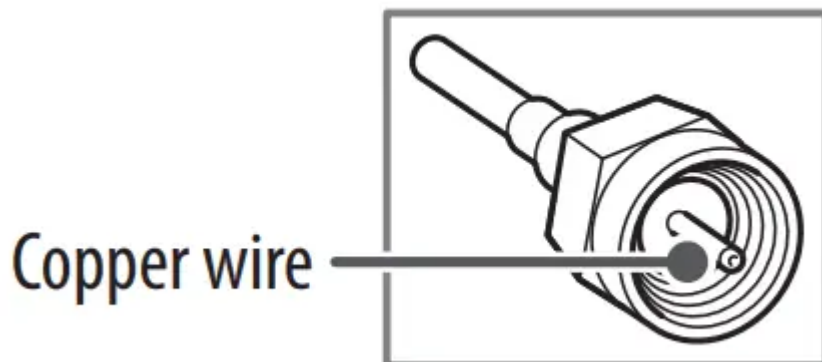

- Complete all connections between devices, and then connect the power cord to the power outlet to prevent damage to your TV.
- Use a signal splitter to use 2 TVs or more.
- DTV Audio Supported Codec: MPEG, Dolby Digital
- This TV cannot receive ULTRA HD (3840 x 2160 pixels) broadcasts directly because the related standards have not been confirmed.

## Starting TV

### Turning on the TV

You can simply operate the TV functions, using the button

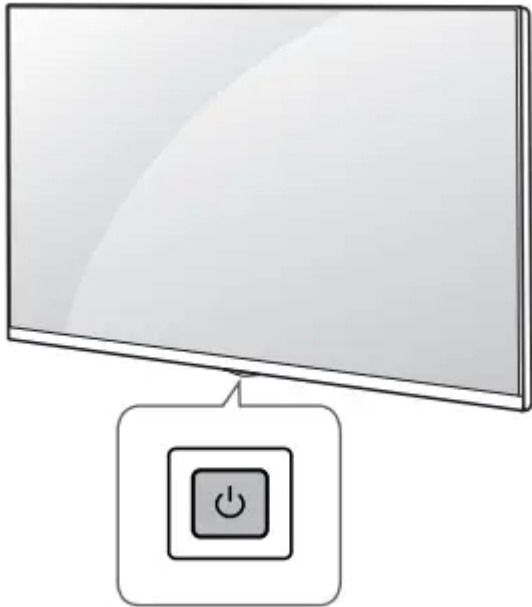

## Using button



Power On (Press)

Power Off<sup>1)</sup> (Press and Hold)

Menu Control (Press<sup>2)</sup>)

Menu Selection (Press and Hold<sup>3)</sup>)

1) All running apps will close.

2) You can access and adjust the menu by pressing the button when TV is on.

3) You can use the function when you access menu control.

## Note

When the TV is turned on for the first time after being shipped from the factory, initialization of the TV may take approximately one minute.

## Adjusting the menu

When the TV is turned on, press the button one time. You can adjust the Menu items using the button.



Turns the power off.



Changes the input source.



Adjusts the volume level.



Scrolls through the saved channels.

## Note

- Your TV's OSD (On Screen Display) may differ slightly from that shown in this manual
- The available menus and options may differ from the input source or product model that you are using
- New features may be added to this TV in the future

- The device must be easily accessed to a location outlet near the access. Some devices are not made by turning on / off button, turning off the device and unplugging the power cord.

### Inserting the battery

(Depending on model)

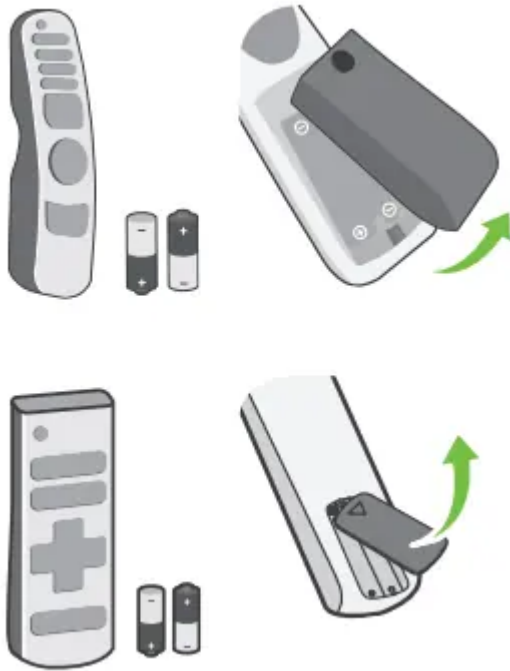

- When the message [Magic Remote battery is low. Please change the battery.] is displayed, replace the batteries. To install batteries, open the battery cover, replace batteries (1.5 V AA) matching the  $\oplus$  and  $\ominus$  ends to the label inside the compartment, and close the battery cover. Be sure to point the magic remote toward the remote control sensor on the TV. To remove the batteries, perform the installation actions in reverse. This remote uses infrared light. When in use, it should be pointed in the direction of the TV's remote sensor.
- To install batteries, open the battery cover, replace batteries (1.5 V AAA) matching the  $\oplus$  and  $\ominus$  ends to the label inside the compartment, and close the battery cover. To remove the batteries, perform the installation actions in reverse. This remote uses infrared light. When in use, it should be pointed in the direction of the TV's remote sensor.

### CAUTION:

- Do not mix new batteries with old batteries. This may cause the batteries to overheat and leak.

- Failure to match the correct polarities of the battery may cause the battery to burst or leak, resulting in fire, personal injury, or ambient pollution.
- This apparatus uses batteries. In your community there might be regulations that require you to dispose of these batteries properly due to environmental considerations. Please contact your local authorities for disposal or recycling information
- Batteries inside or inside the product shall not be exposed to excessive heat such as sunshine, fire or the like.

## Registering Magic Remote Control

### How to register the Magic Remote Control



To use the Magic Remote, first pair it with your TV.



1 Put batteries into the Magic Remote and turn the TV on.

2 Point the Magic Remote at your TV and press the  Wheel (OK) on the remote control.

\* If the TV fails to register the Magic Remote, try again after turning the TV off and back on

### How to deregister the Magic Remote Control

Press the  (Back) and  (Home) buttons at the same time, for five seconds, to unpair the Magic Remote with your TV.

\* Press and hold the  (Home) and  (Q.Settings) buttons for more than 5 seconds to disconnect and re-register the Magic Remote at the same time.

**CAUTION:** It is recommended that an Access Point (AP) be located more than 0.2 m (0.65 ft) away from the TV. If the AP is installed closer than 0.2 m (0.65 ft), the Magic remote control may not perform as expected due to frequency interference.

## Using Remote Control

### Using Magic Remote Control

(Depending on model)

The descriptions in this manual are based on the buttons on the remote control. Please read this manual carefully and use the TV correctly

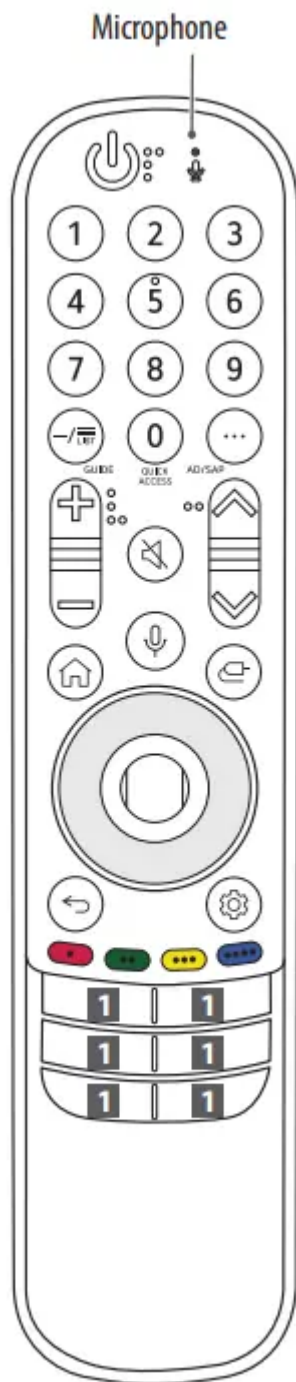

 Power Turns the TV on or off

 — (Dash) Inserts a — between numbers such as 2-1 and 2-2.

 LIST Accesses the saved channel list.

**GUIDE\*\*** Accesses the [Guide].

**QUICK \*\*  
ACCESS** Accesses the [Edit Quick Access].

[Edit Quick Access] is a feature that allows you to enter a specified app or Live TV directly by pressing and holding the number button



Volume buttons Adjusts the volume level.



Channel buttons Scrolls through the saved channels.



Home Accesses the Home menu



Home Launches the last used apps



Input Changes the input source.



Input Accesses the [Home Dashboard].



Wheel (OK) Press the center of  button to select a menu. You can change channels by

using  button.



Wheel (OK) Accesses the [Magic Explorer]. You can run the [Magic Explorer] feature when the pointer color is changed to purple. If watching a program, press and hold down the pointer onto the video. When using [TV Guide], [Settings], [Sports Alert], or [Art Gallery], press and hold down on the text.

**Number buttons** Enters numbers



Accesses the [Quick Help].



More actions Displays more remote control functions

**AD/SAP**<sup>\*\*</sup>

SAP (Secondary Audio Program) feature can also be enabled by pressing the **...** button.



Mute Mutes all sounds.



Mute Accesses the [Accessibility] menu. Voice recognition Network connection is required to use the voice recognition function.

Check for recommended content. (Some recommended services may not be available in some countries.)



Voice recognition Network connection is required to use the voice recognition function.

Check for recommended content. (Some recommended services may not be available in some countries.)



Voice recognition Speak while pressing and holding the button to use the voice recognition feature



Up/Down/Left/Right Press the up, down, left or right button to scroll the menu. If you press



buttons while the pointer is in use, the pointer will disappear from the screen and Magic Remote will operate like a general remote control. To display the pointer on the screen again, shake Magic Remote to the left and right



Q. Settings Accesses the Quick Settings.



Q. Settings Displays the [All Settings] menu.



Back Returns to the previous level.



Back Clears on-screen displays and returns to last input viewing.



These access special functions in some menus.



Red button Runs the record function.



Streaming Service buttons Connects to the Video Streaming Service

## Using Remote Control

(Depending upon model)

The descriptions in this manual are based on the buttons on the remote control. Please read this manual carefully and use the TV correctly

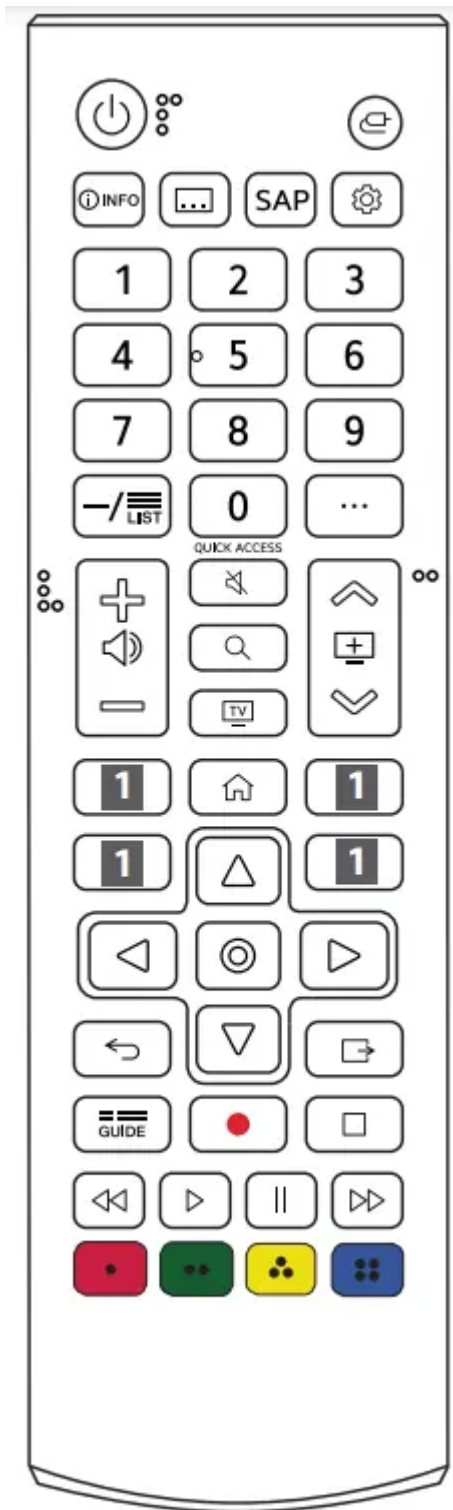

Power Turns the TV on or off



— (Dash) Inserts a — between numbers such as 2-1 and 2-2.



Accesses the saved channel list.



Displays the program event according to time scheduler.



Shows information on the current program.



Recalls your preferred subtitle in digital mode



Enables SAP (Secondary Audio Program) Feature



Accesses the [Edit Quick Access].

[Edit Quick Access] is a feature that allows you to enter a specified app or Live TV directly by pressing and holding the number button



Volume buttons Adjusts the volume level.



Channel buttons Scrolls through the saved channels.



Home Accesses the Home menu



Home Launches the last used apps



Input Changes the input source.



OK Selects menus or options and confirms your input



Wheel (OK) Accesses the [Magic Explorer]. You can run the [Magic Explorer] feature when the pointer color is changed to purple. If watching a program, press and hold down the pointer onto the video. When using [TV Guide], [Settings], [Sports Alert], or [Art Gallery], press and hold down on the text

**Number buttons** Enters numbers

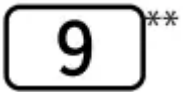

Accesses the [Quick Help].

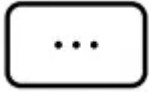

More actions Displays more remote control functions



Mute Mutes all sounds.



Mute Accesses the [Accessibility] menu



Navigation button (up / down / left / right) Scrolls through menus or options.



Q. Settings Accesses the Quick Settings

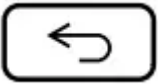

Back Returns to the previous level.

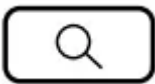

Search Check for recommended content. (Some recommended services may not be available in some countries.) Shows the search mode



You can watch TV or LG Channels.



Clears on-screen displays and returns to last input viewing.

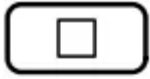

Control buttons Control buttons for media contents.



These access special functions in some menus.



Starts to record. (Only Time Machine Ready supported model)

**1**

Streaming Service buttons Connects to the Video Streaming Service

## Connections

You can connect various external devices to the TV. For more information on external device's connection, refer to the manual provided with each device. Connect your TV to external devices. For the best picture and audio quality, connect the external device and the TV with the HDMI cable.

### HDMI

- When connecting the HDMI cable, the product and external devices should be turned off and unplugged.

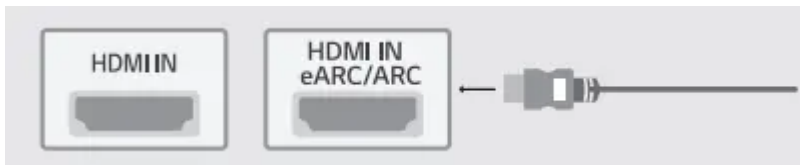

- HDMI Audio Supported Format: (Depending upon model) True HD (48 kHz), Dolby Digital / Dolby Digital Plus (32 kHz / 44.1 kHz / 48 kHz), PCM (32 kHz / 44.1 kHz / 48 kHz / 96 kHz / 192 kHz)

## NOTE

If the device connected to Input Port also supports HDMI Deep Color, your picture may be clearer. However, if the device doesn't support it, it may not work properly. In that case, change the TV's [HDMI Deep Color] setting to off.

- →  → [General] → [Devices] → [HDMI Settings] → [HDMI Deep Color] (Except for 82/86UP87\*)
  - On: Support 4K @ 50 / 60 Hz (4:4:4, 4:2:2, 4:2:0)
  - Off: Support 4K @ 50 / 60 Hz (4:2:0)
- (For 82/86UP87\*)
  - On: Support 4K @ 50 / 60 Hz (4:4:4, 4:2:2, 4:2:0), 4K @ 100 / 120 Hz (4:4:4, 4:2:2, 4:2:0)
  - Off: Support 4K @ 50 / 60 Hz (4:2:0)
  - This feature is available only on certain models which support HDMI Ultra HD Deep Color.
- Use a certified cable with the HDMI logo attached. If you do not use a certified HDMI cable, the screen may not display or a connection error may occur.
- Recommended HDMI cable types (3 m (9.84 feet) or less)
  - Ultra High Speed HDMI®/™ cable

## NOTE

- For an optimal connection, HDMI cables and USB devices should have bezels less than 8 mm (0.31 inches) thick, 18 mm (0.7 inches) width and 8 mm (0.31 inches) a wire diameter. (Depending upon model)
- Use an extension cable that supports USB 2.0 if the USB cable or USB flash drive does not fit into your TV's USB port.

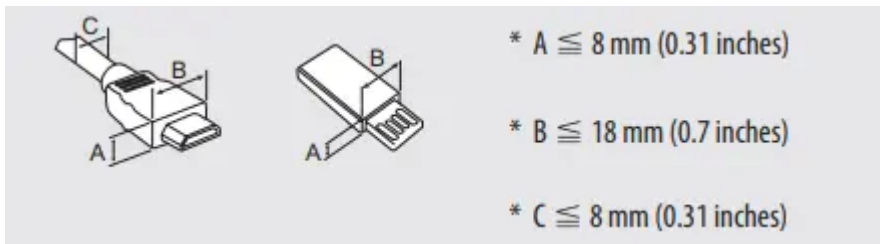

## External Devices

Supported external devices are: Blu-ray player, HD receivers, DVD players, VCRs, audio systems, USB storage devices, PC, gaming devices, and other external devices. For more information on external device's connection, refer to the manual provided with each device

### NOTE

- If you record a TV program on a Blu-ray/DVD recorder or VCR, make sure to connect the TV signal input cable to the TV through a DVD recorder or VCR. For more information about recording, refer to the manual provided with the connected device.
- The external device connections shown may differ slightly from illustrations in a manual.
- Connect external devices to the TV regardless about the order of the TV port.
- If you connect a gaming device to the TV, use the cable supplied with the gaming device.
- Refer to the external equipment's manual for operating instructions.
- In PC mode, there may be noise associated with the resolution, vertical pattern, contrast or brightness. If noise is present, change the PC output to another resolution, change the refresh rate to another rate or adjust the brightness and contrast on the [Picture] menu until the picture is clear. Depending upon the graphics card, some resolution settings may not allow the image to be positioned on the screen properly.
- Some USB Hubs may not work. If a USB device connected through a USB Hub is not detected, connect it directly to the USB port on the TV.
- When connecting via a wired LAN, it is recommended to use a CAT 7 cable.
- The TV may be capable of operating without a set-top-box from a multichannel video programming distributor (MVPD)

### Remote RS-232C setup

To obtain the RS-232C external control setup information, please visit [www.lg.com](http://www.lg.com). Download and read the manual, (Depending upon model).

# Troubleshooting



<p>Cannot control the TV with the remote control.</p>	<ul style="list-style-type: none"> <li>• Check if anything such as tape has been placed over the receiver.</li> <li>• Check if there is any obstacle between the product and the remote control.</li> <li>• Replace the batteries with new fresh ones</li> </ul>
<p>No image display and no sound is produced.</p>	<ul style="list-style-type: none"> <li>• Check if the product is turned on.</li> <li>• Check if the power cord is connected to a wall outlet.</li> <li>• Check if there is a problem in the wall outlet by connecting other products</li> </ul>
<p>The TV turns off suddenly.</p>	<ul style="list-style-type: none"> <li>• Check the power control settings. The power supply may be interrupted.</li> <li>• Check if the auto-off function is activated in the settings menu.</li> <li>• If there is no signal while the TV is on, the TV will turn off automatically after 15 minutes of inactivity.</li> </ul>
<p>Abnormal Display</p>	<ul style="list-style-type: none"> <li>• If the TV feels cold to the touch, there may be a small flicker when it is turned on. This is normal; there is nothing wrong with TV. Some minute dot defects may be visible on the screen, appearing as tiny red, green, or blue spots. However, they have no adverse effect on the TV's performance. Avoid touching the LCD screen or holding your finger(s) against it for long periods of time. Doing so may produce some temporary distortion effects on the screen.</li> <li>• This panel is an advanced product that contains millions of pixels. In a very few cases, you could see fine dots on the screen while you're viewing the TV. Those dots are deactivated pixels and do not affect the performance and reliability of the TV.</li> <li>• Displaying a still image for a prolonged period of time may cause an image sticking. Avoid displaying a fixed image on the TV screen for an extended length of time.</li> </ul>

Generated Sound	<p>Cracking noise A cracking noise that occurs when watching or turning off the TV is generated by plastic thermal contraction due to temperature and humidity. This noise is common for products where thermal deformation is required.</p> <p>Electrical circuit humming/panel buzzing A low level noise is generated from a high-speed switching circuit, which supplies a large amount of current to operate a product. It varies depending upon the product. This generated sound does not affect the performance and reliability of the product.</p>
-----------------	--

## CAUTION

- When cleaning the product, be careful not to allow any liquid or foreign objects to enter the gap between the upper, left or right side of the panel and the guide panel (Depending upon model).

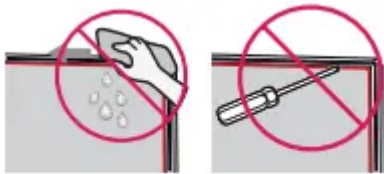

- Make sure to wring any excess water or cleaner from the cloth.
- Do not spray water or cleaner directly onto the TV screen.
- Make sure to spray just enough of water or cleaner onto a dry cloth to wipe the screen.

## Specifications

Product specifications may be changed without prior notice due to upgrade of product functions.

Estimated yearly energy consumption indicated on the FTC label is measured in accordance with the Test Procedures for Television Sets (USA only)

The actual energy consumption depends on the usage environment (The content watched, TV settings, etc).

- For information of the power supply and power consumption, refer to the label attached to the product.
- The typical power consumption is measured in accordance with IEC 62087 or each country's energy regulations.
- \* On some models, the label is inside the external device connection terminal cover.
- \* Depending upon the model or country, the typical power consumption may not be on label

Broadcasting Specifications	
Television system	ATSC / NTSC-M, 64 & 256 QAM
Program coverage	VHF 2-13, UHF 14-69, DTV 2-69, CATV 1-135, CADTV 1-135
External antenna impedance	75 Ω

(For 82/86UP87\*)

Wireless module(LGSBWAC95)Specifications	
Wireless LAN (IEEE 802.11a/b/g/n/ac)	
Frequency range	Output Power (Max.)
2,400 to 2,483.5 MHz	18.5 dBm
5,150 to 5,725 MHz	18 dBm
5,725 to 5,850 MHz	18 dBm
Bluetooth	
Frequency range	Output power(Max.)
2,400 to 2,483.5 MHz	9 dBm

### Warning

This content is compiled from multiple sources and is provided for reference purposes only. It may not be complete or fully applicable to all situations. If you are unable to resolve your issue, please contact the product manufacturer or an authorized service provider for official support.