

Connect With Your Smartphone

You will need:



- Wi-Fi® enabled smartphone, tablet or laptop
- Broadband Internet Connection
- Wi-Fi® signal in the garage (2.4 GHz, 802.11b/g/n required)
- Password for your home network (router's main account, not guest network)

Test the Wi-Fi® Signal Strength

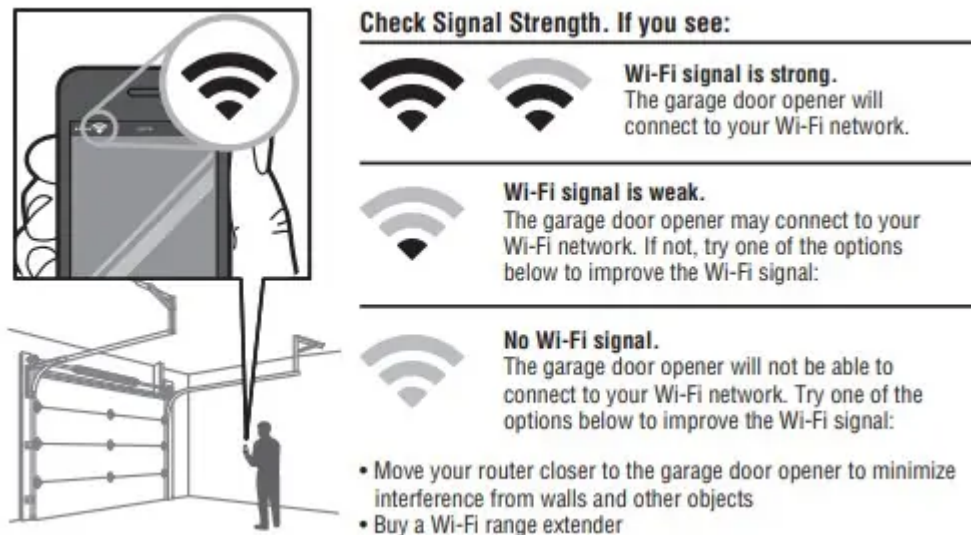
Make sure your mobile device is connected to your Wi-Fi® network. Hold your mobile device in the place where your garage door opener is installed and check the Wi-Fi signal strength.



Check Signal Strength. If you see:

  **Wi-Fi signal is strong.**
The garage door opener will connect to your Wi-Fi network.

 **Wi-Fi signal is weak.**
The garage door opener may connect to your Wi-Fi network. If not, try one of the options below to improve the Wi-Fi signal:

 **No Wi-Fi signal.**
The garage door opener will not be able to connect to your Wi-Fi network. Try one of the options below to improve the Wi-Fi signal:

- Move your router closer to the garage door opener to minimize interference from walls and other objects
- Buy a Wi-Fi range extender

Download the myQ® App to Set Up an Account and Connect

Open and close your door, get alerts and set schedules from anywhere. Connected smart garage door openers also receive software updates to ensure the opener has the latest operational features. The garage door opener must run through a complete cycle before it will activate Wi-Fi® programming.

1. Download the myQ® App.
2. Set up an account and connect.

If you already have the myQ® App installed:

1. Check that your mobile device has the latest software.
2. Download the latest version of the myQ® App.



For more information on connecting your garage door opener, visit [chamberlaingroup support website](http://chamberlaingroup.com/support)

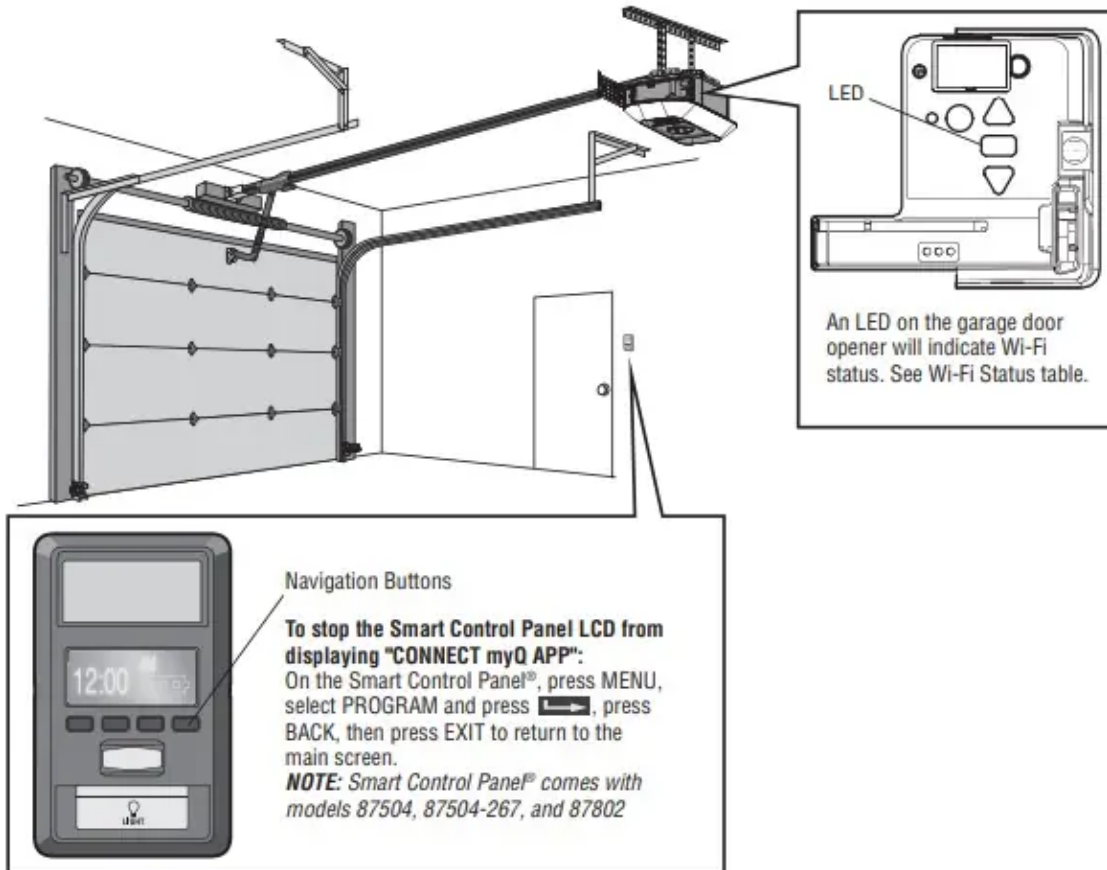

Programming

Remote Control

Pre-programmed remote control included, no need to program the remote.

To add or reprogram a remote control, follow the instructions below.

Program Using the Garage Door Opener LEARN Button

1. Press and release the LEARN button on the garage door opener.
2. Press and hold the button on the remote control that you wish to use. Release the button when the garage door opener lights blink or two clicks are heard.

Program Using the Smart Control Panel®

- Select Menu > Program > Remote and follow the on screen prompts.

Program Using the Multi-Function or Motion-Detecting Control Panel

1. Press the LEARN button on the door control to enter programming mode.
2. Press the LEARN button again, the command LED will flash once.
3. Press the button on the remote control that you wish to operate your garage door.

Wireless Keyless Entry

Refer to the instructions provided with your keyless entry OR go to LiftMaster.com to download instructions.

HomeLink®

If your vehicle is equipped with a HomeLink®, you may require an external adapter depending on the make, model, and year of your vehicle. Visit homelink website for additional information.

To Erase the Memory

Erase ALL Remote Controls and Keyless Entries

- Press and hold the LEARN button until the LED goes out (approximately 6 seconds).
- All remote controls and keyless entries are now erased.

Erase ALL Devices (Including myQ® enabled accessories)

1. Press and hold the LEARN button until the LED goes out (approximately 6 seconds).
2. Immediately press and hold the LEARN button until the LED goes out. All codes are now erased.

Erase the Wi-Fi Network from the Garage Door Opener

- Press and hold the adjustment button until 3 beeps are heard (approximately 6 seconds).

Erase the Camera Settings - Models 87504 and 87504-267

- Press and hold the reset button on the side of the camera for 10 seconds. The LED light will turn off, then flash red. You will need to set up your camera again after resetting it.

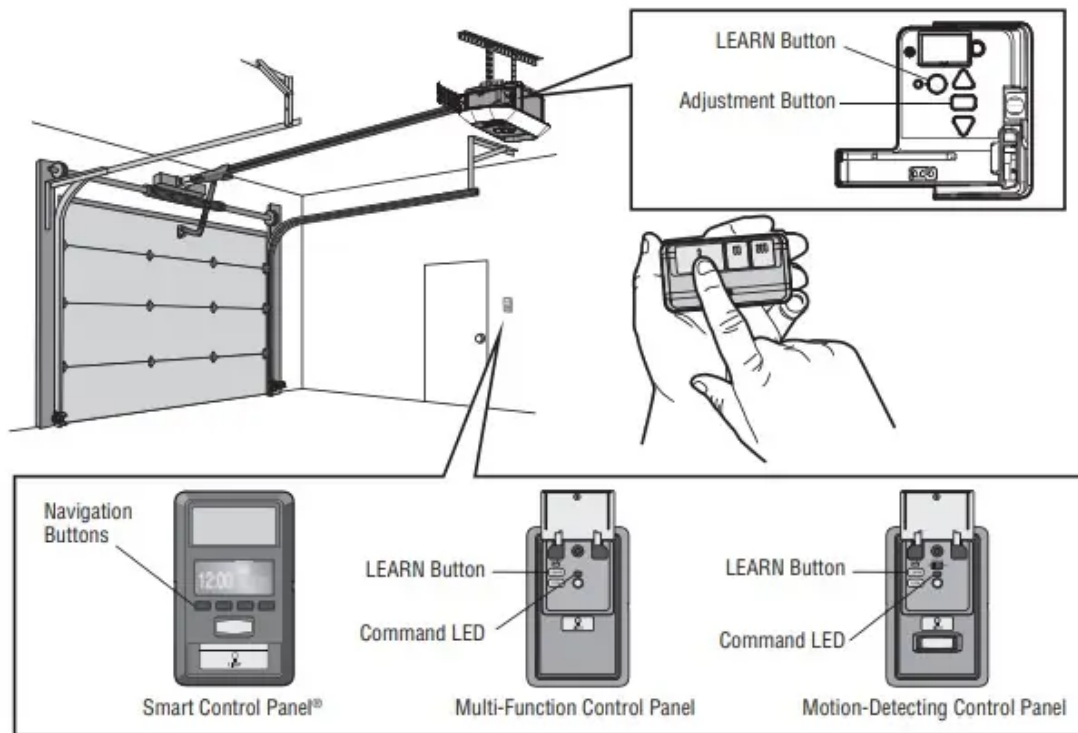

Operation

To Open the Door Manually

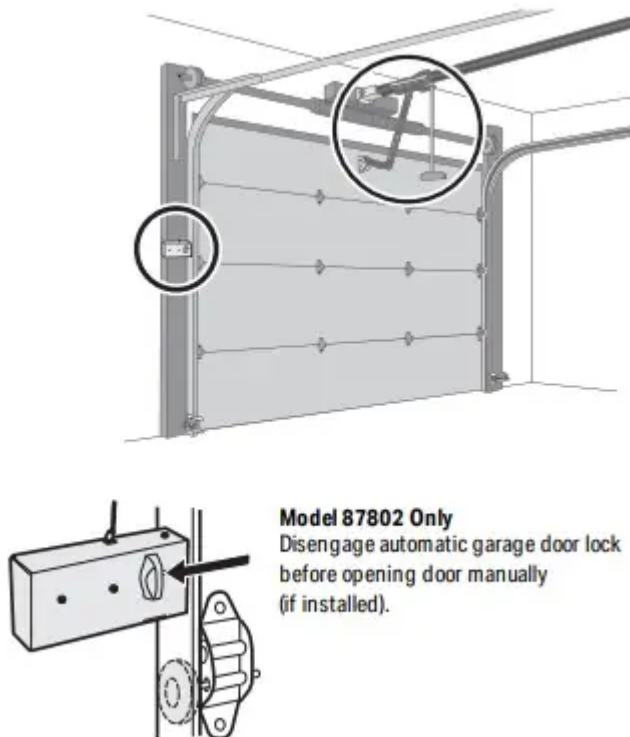

NOTE: Disengage any door locks before proceeding.

1. The door should be fully closed if possible.

2. Pull down on the emergency release handle.

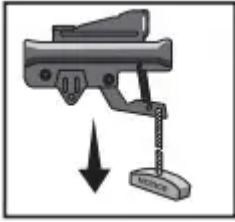

Lockout Feature

1. Pull the emergency release handle down and back. The door can then be raised and lowered manually as often as necessary
2. To disengage the lockout feature, pull the handle straight down.

The trolley will reconnect on the next time the opener is activated.



Door Controls

Multi-Function Control Panel 882LMW - Model 84501

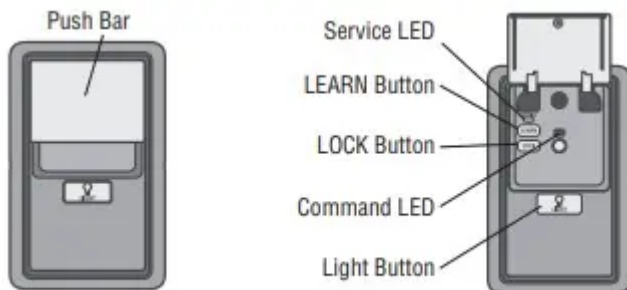

The Protector System® (Safety Reversing Sensors)

The door will not close if the sensors have not been installed and aligned correctly.

When the light beam is obstructed or misaligned while the door is closing, the door will reverse and the garage door opener lights will flash ten times. If the door is already open, it will not close. The sensors can be aligned by loosening the wing nuts, aligning the sensors, and tightening the wing nuts. Check to make sure the LEDs in both sensors are glowing steadily. The LEDs in both sensors will glow steadily if they are aligned and wired correctly.

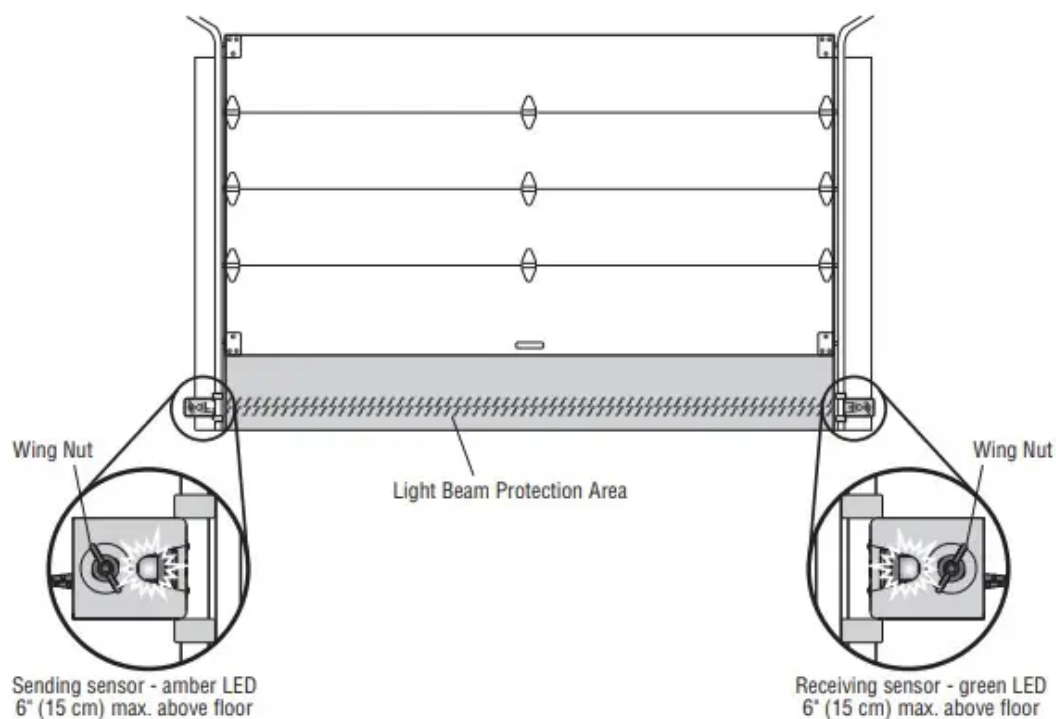

If either of the sensor LEDs are off, there is no power to the sensor:

1. Check that you have power to the garage door opener.
2. Check the sensor wire is not shorted or broken.
3. Check that the sensors are wired correctly; white wires to white terminal and white/black wires to grey terminal.

If the green receiving sensor LED is blinking, the sensors are obstructed or misaligned:

1. Check for obstructions in the sensor light beam.
2. Align the sensors
3. If the receiving sensor (green LED) faces direct sunlight, switch the sensors to opposite sides of the door to assure proper operation.

Adjustment

Introduction

Your garage door opener is designed with electronic controls to make setup and adjustments easy. The adjustments allow you to program where the door will stop in the open (UP) and close (DOWN) position. The electronic controls sense the amount of force required to open and close the door.

NOTE: If anything interferes with the door's upward travel it will stop. If anything interferes with the door's downward travel, it will reverse.

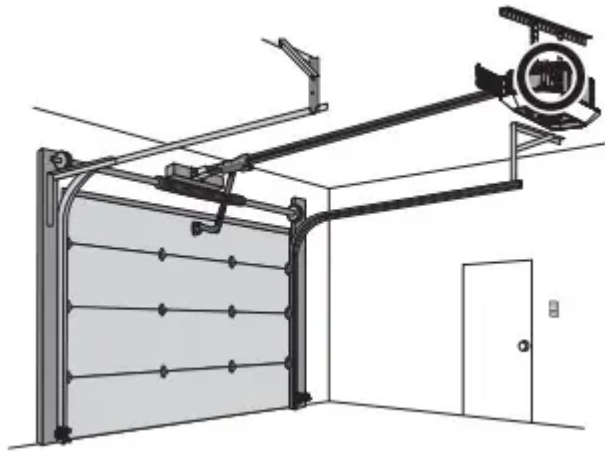

Programming Buttons

The programming buttons are located on the back panel of the garage door opener and are used to program the travel.

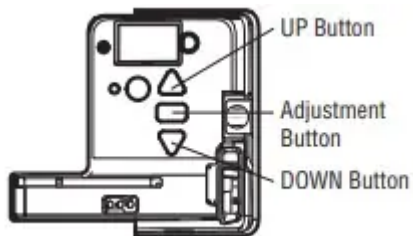

Program the Travel

While programming, the UP and DOWN buttons can be used to move the door as needed.

1. Press and hold the Adjustment Button until the UP Button begins to flash and/or a beep



is heard.

2. Press and hold the UP Button until the door is in the desired UP position.



3. Once the door is in the desired UP position press and release the Adjustment Button.
The garage door opener lights will flash twice and the DOWN Button will begin to flash.



4. Press and hold the DOWN button until the door is in the desired DOWN position.



5. Once the door is in the desired DOWN position press and release the Adjustment Button.
The garage door opener lights will flash twice and the UP Button will begin to flash.



6. Press and release the UP Button. When the door travels to the programmed UP position,



the DOWN Button will begin to flash.

7. Press and release the DOWN Button. The door will travel to the programmed DOWN



position. Programming is complete.

- If the garage door opener lights are flashing 5 times during the steps for Program the Travel, the programming has timed out. If the garage door opener lights are flashing 10 times during the steps for Program the Travel, the safety reversing sensors are misaligned or obstructed. When the sensors are aligned and unobstructed, cycle the door through a complete up and down cycle using the remote control or the UP and DOWN buttons. When the UP and DOWN buttons stop flashing, programming is complete. If you are unable to operate the door up and down, repeat the steps for Program the Travel.

Maintenance

Every Month

- Manually operate door. If it is unbalanced or binding, call a trained door systems technician.
- Check to be sure door opens and closes fully. Adjust if necessary, page 13.
- Test the safety reversal system. Adjust if necessary, page 14.

Every Year

- Oil door rollers, bearings and hinges. The garage door opener does not require additional lubrication. Do not grease the door tracks.
- (If applicable) Test the battery backup and consider replacing the battery to ensure the garage door opener will operate during an electrical power outage.
 1. Unplug the garage door opener from AC power. The battery status LED will glow solid orange (opener is operating on battery power) or will flash (low battery power).
 2. Open and close the door using the remote control or door control.
 3. In battery backup mode, the Automatic Garage Door Lock will unlock when the garage door is opened, and will remain disabled until power is restored.
 4. Plug in the garage door opener. Verify the battery status LED is flashing green (battery is charging).

Troubleshooting

Below are basic troubleshooting tips, for additional help and support videos visit support.liftmaster.com or contact your installing dealer.

My garage door opener will not close and the lights flash 10 times (no beeps occur):

- Check to make sure the LEDs in both sensors are glowing steadily. The LEDs in both sensors will glow steadily if they are aligned and wired correctly.

My vehicle's Homelink® is not programming to my garage door opener:

- Depending on the make, model, and year of your vehicle an external adapter may be required. Visit [homelink website](http://homelink.com) for additional information

My garage door opener beeps:

The garage door opener can beep for several reasons

- The opener senses an obstruction while traveling.
- Garage door opener has been activated through a device or feature such as Timer-to-Close, garage door monitor or LiftMaster Internet Gateway.

My neighbor's remote control opens my garage door:

- Erase the memory from your garage door opener and reprogram the remote control(s).

The garage door moves 6-8", stops or reverses:

- Manually open and close the garage door. Garage door may be binding or there may be an obstruction. If the door is binding, call a trained door systems technician.
- Possible travel module failure.

My remote control will not activate the garage door:

- Verify the lock feature is not activated on the door control or reprogram the remote control.

The wall-mounted door control will not function:

- The wires for the door control are shorted or the door control is faulty.

My garage door opener light(s) will not turn off when the door is open:

- The garage door opener is equipped with a feature that turns the light on when the safety reversing sensors have been obstructed or when the motion sensor on the door control detects movement in the garage. This feature can be disabled using the door control.

Garage door opener hums for 1-2 seconds with no movement and 5 flashes and 5 beeps occur:

- Manually open and close the garage door. Garage door may be binding or there may be an obstruction. If the door is binding, call a trained door systems technician.

Cannot connect garage door opener to home Wi-Fi network:

- Ensure the myQ® Serial number was entered correctly and try again. The myQ® characters are between A-F and 0-9 only.

My camera won't connect to the router:

- Move your router closer to the garage door opener to minimize interference from walls and other objects.
- Buy a Wi-Fi range extender.

For issues with the camera, press and hold the reset button on the camera for 10 seconds. Then, follow the myQ® app instructions to set up the camera.

To troubleshoot the optional automatic garage door lock model 841LM, see the instructions provided with it.

Automatic Garage Door Opener Safety & Maintenance Guide

Garage Door Opener Safety – An Automatic Decision

A garage door is the largest moving object in the home. An improperly adjusted garage door and opener can exert deadly force when the door closes – which could lead to entrapment of children or adults and subsequent injury or death.

- Proper installation, operation, maintenance, and testing of the garage door and automatic opener are necessary to provide a safe, trouble-free system. Careless operation or allowing children to play with or use garage door opener controls are also dangerous situations that can lead to tragic results. A few simple precautions can protect your family and friends from potential harm. Please review the safety and maintenance tips in this guide carefully and keep it for reference. Check the operation of your garage door and opener to ensure they function in a safe and trouble-free manner. Be sure to read all Important Safety Information found in your garage door opener’s manual as it provides more details and safety considerations than can be supplied with this guide.

Garage Door Openers are Not Toys

Discuss garage door and opener safety with your children. Explain the danger of being trapped under the door.

- Stay away from a moving door.



- Keep transmitters and remote controls out of reach of children. Do not let children play with or use transmitters or other remote control devices.



- The wall-mounted push button should be out of reach of children, at least 5 feet from the nearest standing surface and away from all moving parts. Mount and use the button where you can clearly see the closing garage door.



- Keep the door in sight until it completely closes when using the wall-mounted push button or transmitter.



Routine Maintenance Can Prevent Tragedies

Make monthly inspection and testing of your garage door and opener system a part of your regular routine. Review your owner's manual for both the door and door opener. If you don't have the owner's manuals, contact the manufacturer(s) and request a copy for your specific model(s). Look for the opener model number on the back of the power unit.



Visually check the door and installation:

- Starting with the door in the closed position, use the manual disconnect on the opener to disconnect the door.
- Look for signs of wear or damage on hinges, rollers, springs, and door panels.
- These parts may require periodic lubrication. Check the owner's manual for suggested maintenance.
- If any signs of damage are evident, contact a trained door systems technician for assistance.
- Verify the photoeye height is no higher than 6" from the garage floor.

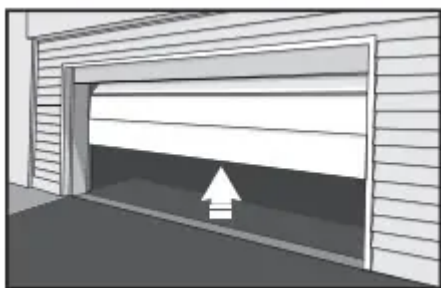

Test the door for proper operation:

- Open and close the door manually using handles or suitable gripping points.
- The door should move freely and without difficulty.
- The door should balance and stay partially open 3–4 feet above the floor.
- If you detect any signs of improper operation, contact a trained door systems technician for assistance.

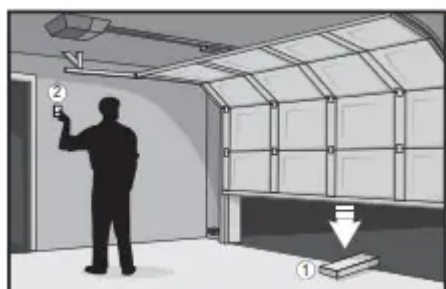

Test the opener safety features:

- Reconnect the opener to the door using the manual disconnect and open the door.
- Place a 2x4 board flat in the path of the door (1) and try to close it (2). The door should stop when it comes in contact with the 2x4 and then reverse direction.
- Block the photoelectric sensor by waving an object in front of the sensor and attempt to close the door. The door should not close unless the wall-mounted push button is manually held during operation.
- If the opener does not perform as described, contact a trained door systems technician for assistance.

Warning

This content is compiled from multiple sources and is provided for reference purposes only. It may not be complete or fully applicable to all situations. If you are unable to resolve your issue, please contact the product manufacturer or an authorized service provider for official support.