

Installation

Refrigerator at a glance

The actual refrigerator and provided parts of your refrigerator may differ from the illustrations in this manual, depending on the model and the country.

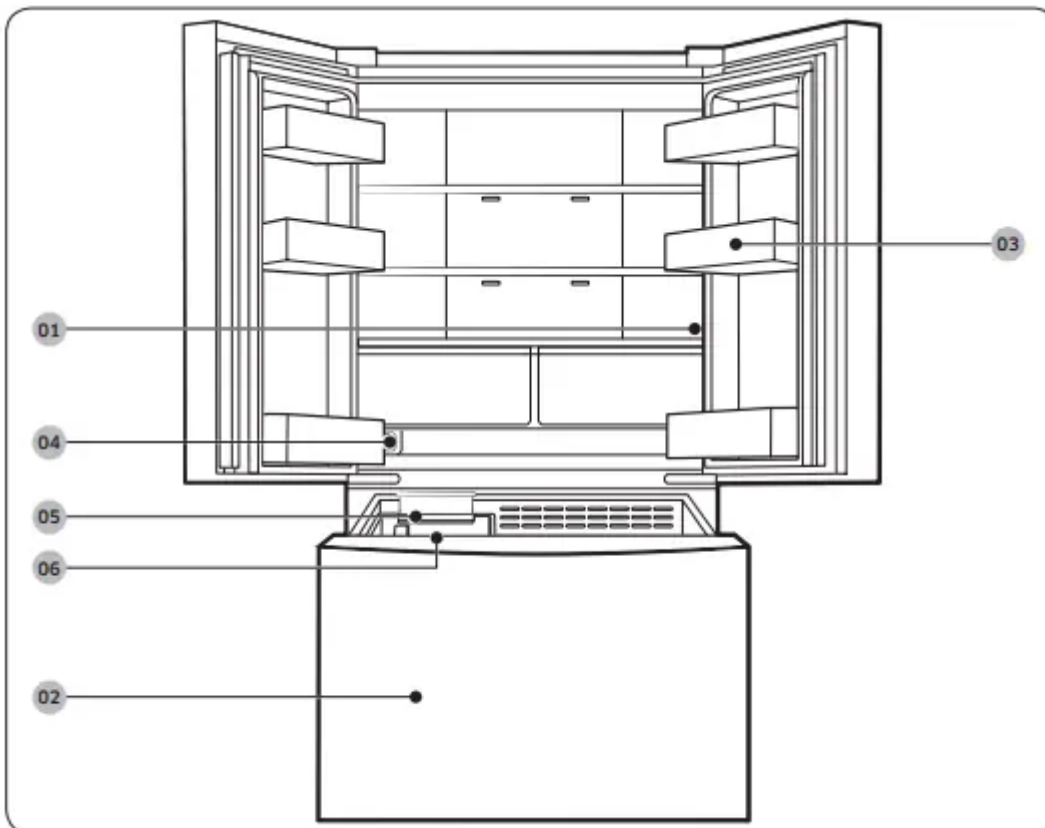

01 Main panel

02 Freezer

03 Door bins

04 Water filter

05 Ice Maker *

06 Ice bucket *

* applicable models only

NOTE

- For energy efficiency, keep all shelves, drawers, and baskets in their original positions.
- When closing the door, make sure the vertical hinged section is in the correct position to avoid scratching the other door.

- If the vertical hinged section is reversed, put it back into the correct position, and then close the door.
- Moisture may form at times on the vertical hinged section.
- If you close a door forcefully, the other door may open.
- If the internal or external LED lamp is out of order, contact a local Samsung service center.
- If the door is left open for too long, the top internal LED will blink. This is normal.

Step-by-step installation

STEP 1 Select a site

Select a site that:

- Has a solid, level surface without carpeting or flooring that may obstruct ventilation
- Is away from direct sunlight
- Has adequate room for opening and closing the door
- Is away from any heat sources
- Provides room for maintenance and servicing • Has a temperature range between 50 °F (10 °C) and 109 °F (43 °C)

CAUTION

- If your refrigerator is equipped with an ice maker, provide extra space at the rear of the refrigerator for the water line connection.
- When you install the refrigerator next to a fixed wall, you must provide a minimum clearance of 3 3/4" (95 mm) from the wall to allow the door to swing open.
- Use of an electrical outlet with a ground fault interrupter (GFI) is not recommended.

NOTE

To facilitate moving your refrigerator to its final location, be sure to measure the width and height of doorways, thresholds, ceilings, stairways, and anything else that needs to be taken into consideration to ensure you can move your refrigerator safely. The following diagram illustrates the exact height and depth (factory specifications) of your refrigerator.

Clearance

See the following figures and tables for space requirements for installation.

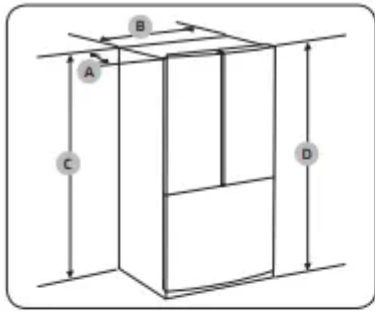

Model	RF22A42*	RF22A41* RF22A40*
Depth "A"	34 ⁷ / ₈ " (886 mm)	34 ¹ / ₂ " (876 mm)
Width "B"	29 ³ / ₈ " (760 mm)	
Height "C"	65 ¹ / ₂ " (1663 mm)	
Overall Height "D"	66 ⁵ / ₈ " (1697 mm)	

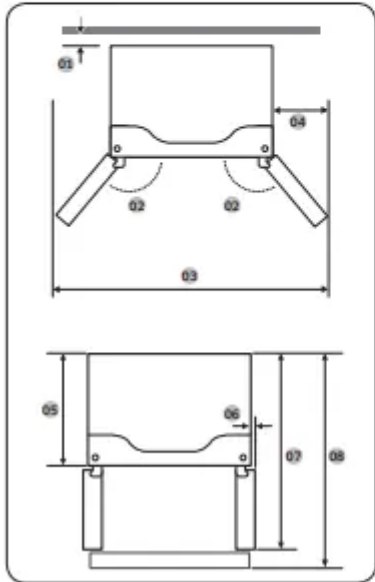

Model	RF22*
01	2" (50 mm)
02	140°
03	51 ³ / ₈ " (1310 mm)
04	10 ³ / ₄ " (275 mm)
05	30 ³ / ₈ " (776 mm)
06	1 ³ / ₈ " (40 mm)
07	46 ³ / ₈ " (1178 mm)
08	50" (1271 mm)

NOTE

The measurements in the table above may differ slightly from the actual measurements, depending on the measuring and rounding method.

STEP 2 Flooring

If the refrigerator cannot pass through the entrance due to its size, see STEP 3 Door removal for entrance.

NOTE

To prevent floor damage, make sure the front leveling legs are in the upright position.

- The surface you install the refrigerator on must support a fully loaded refrigerator.
- To protect the floor, put a large piece of cardboard along the path to the refrigerator's final installation location.
- Once the refrigerator is in its final position, do not move it unless necessary to protect the floor. If you have to move the refrigerator, place thick paper or cloth such as old carpets along the path of movement.

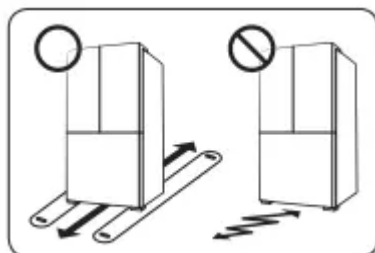

STEP 3 Door removal for entrance

If the refrigerator cannot pass through the entrance to your home or kitchen due to its size, follow these instructions to remove and then re-install the refrigerator's doors

WARNING

Unplug the power cord of the refrigerator before removing the doors.

Tools required (not provided)

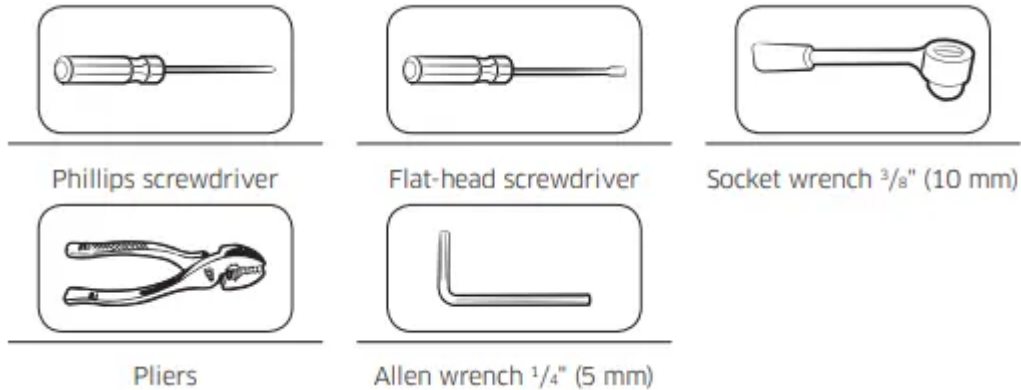

Detach the fridge doors

Left door

1. With the doors closed, use a Phillips head screwdriver to remove the screws (x3) in the top cover.
2. Disconnect the wires and the water tube from the left-side door. Do the following sequentially:
 - Decouple the connector.
 - While holding down one end of the water line coupler, disconnect the water tube.

CAUTION

Keep the water tube clips out of children's reach.

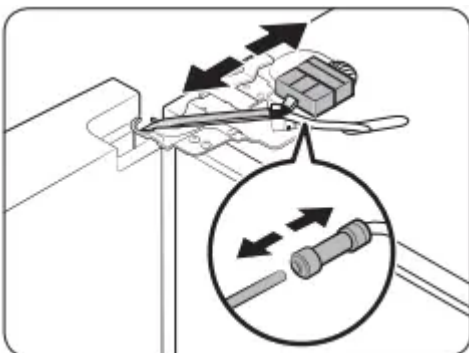

3. Gently draw up the clamp. To prevent finger injuries, do not apply a sudden force to the clamp.

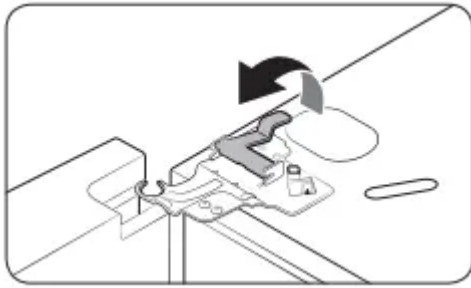

4. Pull the clamp to remove it.

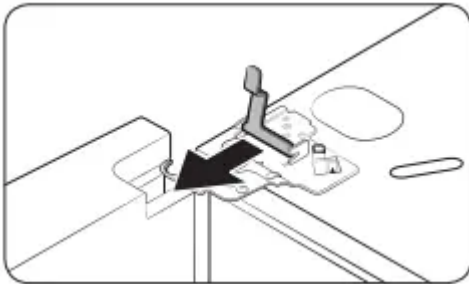

5. Open the door 90 degrees. While holding the door, pull up and remove the top hinge. Be careful not to damage the connector wires when you remove the hinge.

NOTE

Be careful not to drop the hinge on the floor.

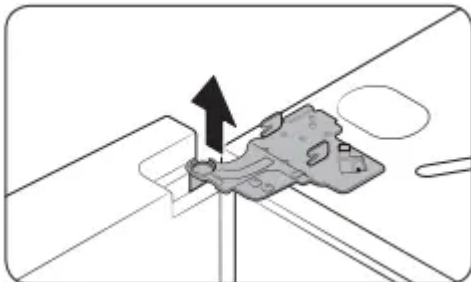

6. Gently pull up the door vertically to remove. Do not apply excessive force to the door. The door may fall, causing physical injury.

7. Lay the door down on a flat surface.

CAUTION

Please put the door down slowly to prevent scratches.

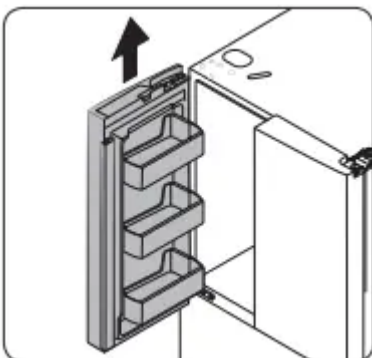

Right door

1. Gently draw up the clamp. To prevent finger injuries, do not apply a sudden force to the clamp.

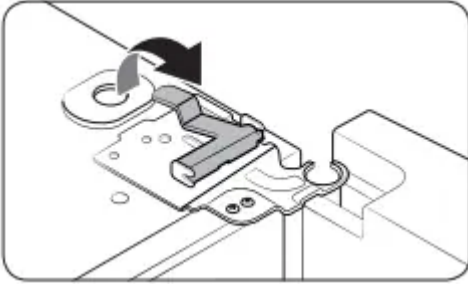

2. Pull the clamp to remove it.

NOTE

Be careful not to drop the clamp on the floor.

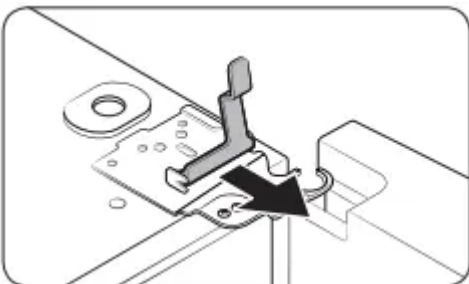

3. Open the door 90 degrees. While holding the door, pull up and remove the top hinge. Be careful not to damage the connector wires when you remove the hinge.

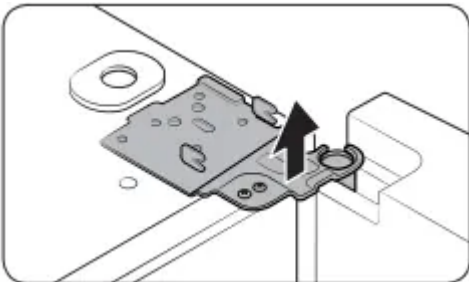

NOTE

Be careful not to drop the hinge on the floor.

4. Gently pull up the door vertically to remove. Do not apply excessive force to the door. The door may fall, causing physical injury.
5. Lay the door down on a flat surface.

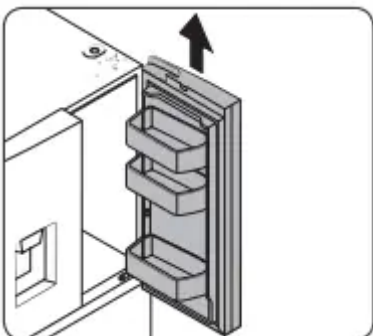

To reattach the fridge door

After you have moved the refrigerator to its final location, reattach the doors by following the removal instructions in reverse order.

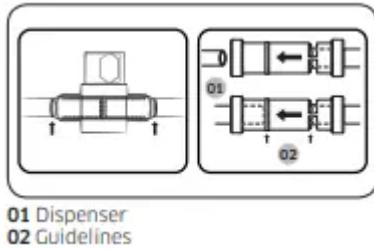

CAUTION To prevent water leaks from the dispenser, the water line must be fully connected. Make sure both tubes of the water line are inserted fully to the center of transparent coupler (A) or the guidelines (B).

To detach the freezer drawer

1. Push the upper basket to the end, and then pull up to remove.
2. Lift up to remove the door bin.

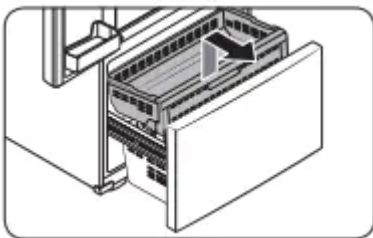

3. Then, pull up to remove the lower basket from the rail assembly.
4. Press down the hooks to unlock the rail assembly.
5. While holding the upper area of the freezer drawer front, slide the drawer out all the way to remove the freezer drawer from the rail assembly.

CAUTION

- Be careful not to scratch or dent the rail assembly.
- Make sure you mount the freezer baskets in the correct position. Otherwise, the door will not open or close properly, which causes frost to build up.
- Do not store too much food in the freezer drawer. This prevents the freezer drawer from closing properly, resulting in frost buildup.

STEP 4 Leveling the refrigerator

CAUTION

- When installed, the refrigerator must be leveled on a flat, solid floor. Not leveling the refrigerator can cause damage to the refrigerator or physical injury.

- Leveling must be performed with the refrigerator empty. Make sure no food items are inside the refrigerator.
- For safety reasons, adjust the front a little higher than the rear.

Level the refrigerator using the special screws (levelers) on the front legs. Use a flat-head screwdriver to turn the levelers.

- To adjust the height of the left side: Insert a flat-head screwdriver into the leveler of the left side front leg. Turn the leveler clockwise to raise the left side or turn it counterclockwise to lower.
- To adjust the height of the right side: Insert a flat-head screwdriver into the leveler of the right side front leg. Turn the leveler clockwise to raise the right side or turn it counterclockwise to lower.

STEP 5 Align the fridge doors

- Before aligning the fridge doors, make sure the refrigerator is level. Refer to the “Leveling the refrigerator” section for detailed instruction.
- You can use the adjustment parts (*) at the bottom of both fridge doors to raise or lower the door.

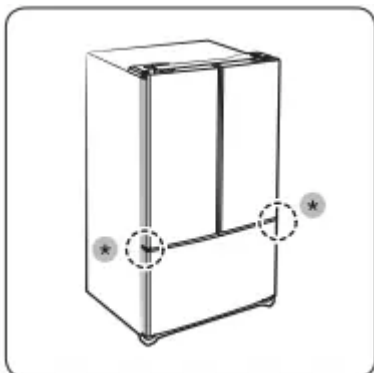

Open the freezer drawer to gain access to the adjustable hinge pin. Next, adjust the refrigerator door using a phillips screwdriver (+).

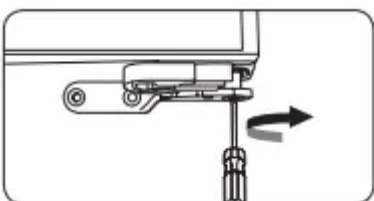

STEP 6 Connect the water dispenser line

A water dispenser with a filter is one of the helpful features on your new refrigerator. To help promote better health, the water filter removes unwanted particles from your water. However, it does not sterilize or destroy microorganisms. You may need to purchase a water purifying system to do that.

The water line also connects to the ice maker. For the ice maker to operate properly, water pressure of 30 to 120 psi (206 to 827 kPa) psi is required. If the refrigerator is installed in an area with low water pressure (below 30 psi / 206 kPa), you can install a booster pump to compensate for the low pressure.

After you have connected the water line, make sure the water storage tank inside the refrigerator is properly filled. To do this, press the water dispenser lever until water runs from the water outlet

1. Shut off the main water source.
2. Insert the pipe clamp (B) and the shutoff valve (C) into the cold water line (A). A B

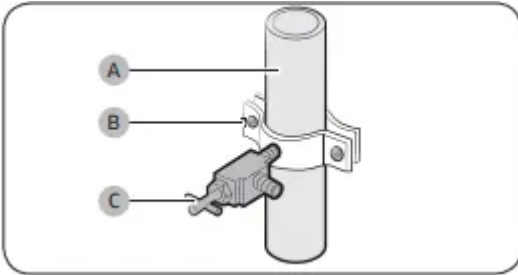

3. Connect the water line installation kit (A) to the shutoff valve (B).

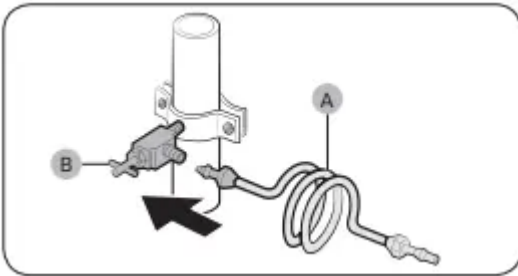

Connect the water supply line to the refrigerator

There are several items you must purchase to complete this connection. You may find these items sold as a kit at your local hardware store.

CAUTION

Do not mount the water filter on any part of the refrigerator. This may damage the refrigerator.

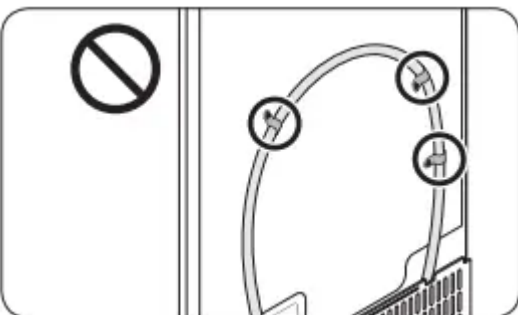

1. Connect the household water line to the assembled compression fitting.
 - If you are using copper tubing, slip the compression nut (B) (not supplied) and ferrule (not supplied) on the copper tubing (not supplied) as shown.

- If you are using plastic tubing (A), insert the molded end (Bulb) of the plastic tubing (A) into the compression fitting.

2. Tighten the compression nut (B) onto the compression fitting. Do not over-tighten the compression nut (B).

3. Turn the water on and check for any leakage. If you find water drops or leakage in the connection areas, turn off the main water supply. Check the connections and, if necessary, tighten.

4. Flush 1 gallon of water through the filter before drinking or using the water from the refrigerator. (Flush approximately 6 minutes.) To flush, press a large glass or cup against the water dispenser lever. Fill the glass, empty it, and then repeat.

5. After you turn on the refrigerator, let the ice maker make ice for 1 to 2 days. Over that period of time, throw out the first 1 or 2 buckets of ice the ice maker makes to ensure all impurities have been removed from the water line.

NOTE

Only connect the water line to a potable water source.

- If you have to repair or disassemble the water line, cut off 1/4" of the plastic tubing to make sure you get a snug, leak-free connection.
- You can test the water line quickly using a paper cup. Under normal conditions, the water dispenser can fill a 5 3/4 oz. (170 cc) cup in about 10 seconds.

STEP 7 Initial settings

By completing the following steps, the refrigerator should be fully functioning.

1. Plug the power cord into the wall socket to turn the refrigerator on.
2. Open the door, and check if the interior light lights up.
3. Set the temperature to the coldest setting, and wait for about an hour. Then, the freezer will be slightly chilled, and the motor should be running smoothly.
4. Wait until the refrigerator reaches the set temperature. Now the refrigerator is ready for use.

STEP 8 Final check

When installation is complete, confirm that:

- The refrigerator is plugged into an electrical outlet and grounded properly.
- The refrigerator is installed on a flat, level surface with a reasonable clearance from walls and cabinets.
- The refrigerator is level and is sitting firmly on the floor.
- The door opens and closes freely, and the interior light turns on automatically when you open the door

Operations

Main panel

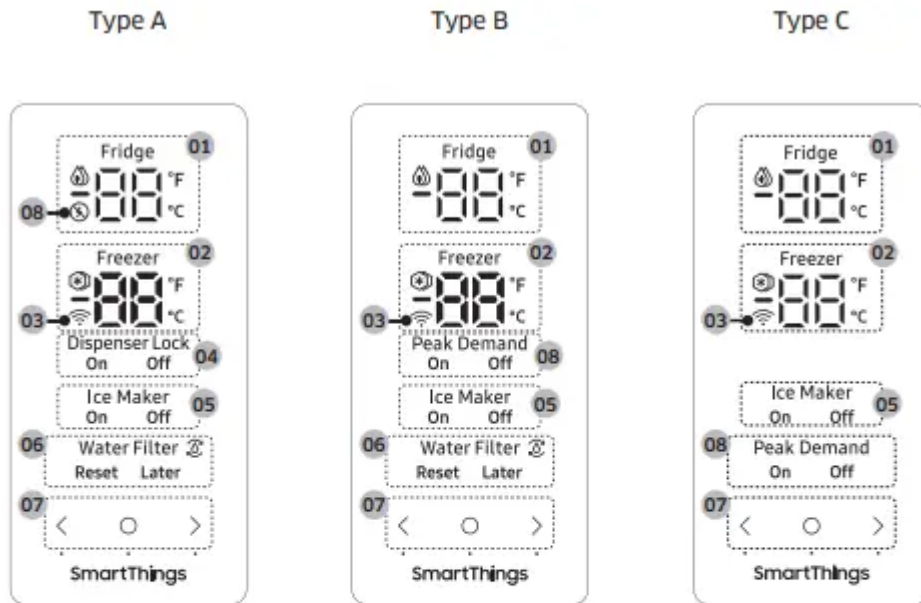

-
- | | |
|--|-----------------------------|
| 01 Fridge indicator | 02 Freezer indicator |
| 03 Network connection indicator | 04 Dispenser Lock * |
| 05 Ice Maker | 06 Water Filter * |
| 07 Buttons | 08 Peak Demand * |

* Applicable models only

01 Fridge indicator

- Displays the current or desired temperature of the fridge.
-  indicates that the Power Cool function is on.

02 Freezer indicator

- Displays the current or desired temperature of the freezer.
-  indicates that the Power Freeze function is on.

03 Network connection indicator

- This icon indicates that the refrigerator is connected to a network.
- You can control and monitor your refrigerator on the SmartThings app. For more information, see the SmartThings section.

04 Dispenser Lock Indicator



- Displays the status of the Dispenser Lock function

- To prevent use of the dispenser lever you can use Dispenser Lock.

05 Ice Maker indicator

- Displays the status of the ice maker.
- To enable ice making, you must turn on the ice maker.

06 Water Filter indicator *

-  indicates that the water filter needs to be replaced.
- When see the  icon, you can replace the water filter and reset the water filter replace alarm, or dismiss the alarm and change the filter later. (For more information, see the "Resetting or dismissing the water filter replacement alarm"

07 Buttons

- When the display is off, tap any button to wake up the display.
- Tap  to select the desired item on the main panel and to confirm any setting changes.
- Tap < or > to change the settings of the selected item on the main panel.

08 Peak Demand indicator *

- Displays the status of the Peak Demand function.
- For more information on the Peak Demand function, see the SMART GRID Function (Demand Response) (applicable models only) section.

Setting the desired temperature or function

Select the fridge or freezer and set the desired temperature or function of your choice.

1. Tap any button (< ,  , or >) to wake up the display.

- This step may not apply to some models.



2. Tap  until the fridge or freezer indicator blinks.

- The selected compartment's indicator blinks.

3. Tap < or > to select the desired temperature or function.



- Refer to the table for available selection for each compartment

Fridge

- Available selection (Fahrenheit):  (Power Cool) <-> 34 °F <-> 35 °F <-> 36 °F <-> 37 °F <-> 38 °F <-> 39 °F <-> 40 °F <-> 41 °F <-> 42 °F <-> 43 °F <-> 44 °F
- Available selection (Celsius):  (Power Cool) <-> 1 °C <-> 2 °C <-> 3 °C <-> 4 °C <-> 5 °C <-> 6 °C <-> 7 °C

- Power Cool speeds up the cooling process at maximum fan speed. The fridge keeps running at full speed for two and a half hours and then returns to the previous temperature.

Freezer



- Available selection (Fahrenheit):  (Power Freeze) <-> -8 °F <-> -7 °F <-> -6 °F <-> -5 °F <-> -4 °F <-> -3 °F <-> -2 °F <-> -1 °F <-> 0 °F <-> 1 °F <-> 2 °F <-> 3 °F <-> 4 °F <-> 5 °F
- Available selection (Celsius):  (Power Freeze) <-> -23 °C <-> -22 °C <-> -21 °C <-> -20 °C <-> -19 °C <-> -18 °C <-> -17 °C <-> -16 °C <-> -15 °C
- Power Freeze speeds up the freezing process at maximum fan speed.
- The freezer keeps running at full speed for 50 hours and then returns to the previous temperature. To freeze large amounts of food, activate Power Freeze for at least 20 hours before putting food in the freezer.

NOTE When you use this function, the energy consumption of the refrigerator will increase. Remember to turn it off when you do not need it and return the freezer to your original temperature setting.

4. Wait for 5 seconds or tap  to confirm your selection.
 - The selected compartment's indicator stops blinking.

Changing the temperature scale



You can switch the temperature scale between Fahrenheit and Celsius.

1. Tap any button (< ,  , or >) to wake up the display.
 - This step may not apply to some models.
2. Tap  until the °F and °C symbols on the fridge or freezer blink.
3. Tap < or > to select the desired temperature scale.
 - Tap < to select Fahrenheit.
 - Tap > to select Celsius.
4. Wait for 5 seconds or tap  to confirm your selection.
 - The °F and °C symbols stop blinking.

Turning on or off the ice maker

You can turn on or off the ice maker in the freezer.



1. Tap any button (< ,  , or >) to wake up the display.
 - This step may not apply to some models.

2. Tap  until the Ice Maker indicator blinks.
3. Tap < or > to turn on or off the ice maker.
 - Tap < to turn it on.
 - Tap > to turn it off.
4. Wait for 5 seconds or tap  to confirm your selection.

The Ice Maker indicator stops blinking.



Turning on or off the Dispenser Lock function

You can turn on or off the Dispenser Lock Function.

1. Tap any button (< ,  , or >) to wake up the display.
 - This step may not apply to some models.
2. Tap  until the Dispenser Lock indicator blinks.
3. Tap or to turn on or off the Dispenser Lock.
 - Tap < to turn it on.
 - Tap > to turn it off.
4. Wait for 5 seconds or tap to confirm your selection.
 - The Dispenser Lock indicator stops blinking.

Resetting or dismissing the water filter replacement alarm



The water filter replacement icon () blinks to alert the user that it is time to replace the water filter. You can replace the water filter immediately and reset the water filter replacement alarm, or dismiss the alarm if you want to change the water filter later.

1. Tap any buttons (< ,  , or >) to wake up the display. - This step may not apply to some models.
2. Tap  until the Water Filter indicator blinks.
3. Tap < or > to select Reset or Later.
 - If you have changed the water filter, tap to reset the water filter replacement alarm.
 - If you want to change the water filter later and dismiss the alarm, tap .
4. Wait for 5 seconds or tap  to confirm your selection.
 - The Water Filter indicator stops blinking.

Turning on or off the Peak Demand function



Display Type A

You can turn on or off the Peak Demand Off (Override Mode) Function. For more information on the Peak Demand function, see the SMART GRID Function (Demand Response) (applicable models only) section.

1. Tap any button (< ,  , or >) to wake up the display.
 - This step may not apply to some models.
2. Press the < button for 3 seconds, while not changing other display settings.
3. When the Peak Demand Off function is deactivated, if you press < button for 3 seconds the Peak Demand Off function will be activated ().
4. When the Peak Demand Off function is activated (), if you press < button for seconds the Peak Demand Off function will be deactivated.

Display Type B, Type C

You can turn on or off the Peak Demand function. For more information on the Peak Demand function, see the SMART GRID Function (Demand Response) (applicable models only) section.

1. Tap any button (< ,  , or >) to wake up the display.
 - This step may not apply to some models.
2. Tap  until the Peak Demand indicator blinks.
3. Tap < or > to turn on or off the function.
 - Tap < to turn it on.
 - Tap > to turn it off.
4. Wait for 5 seconds or tap  to confirm your selection.
 - The Peak Demand indicator stops blinking.

Activating or deactivating the Sabbath mode (applicable models only)

The Sabbath mode stays active for 85 hours once it is activated. After that, it will be deactivated automatically.

- To activate or deactivate the Sabbath Mode, tap and hold  and > simultaneously for 6 seconds. Then, when the display blinks, tap > .
 - When the refrigerator is in the Sabbath mode, the buttons, display, and internal lights do not function. The refrigerator and freezer, however, continue to cool.

NOTE

- If the refrigerator powers off and restarts (for example, if there is a power failure), the Sabbath mode remains active. To end Sabbath Mode, you must deactivate it as instructed above.

Activating or deactivating the Cooling Off mode

The Cooling Off mode (also called the Shop mode) is designed for retailers to display refrigerators on a retail floor. In the Cooling Off mode, the refrigerator's fan motor and lights operate normally, but the compressors do not run, so neither the refrigerator nor the freezer becomes cold.

- To activate or deactivate the Cooling Off mode, tap and hold < and > simultaneously for 6 seconds. Then, when the display blinks, press 
 - When the Cooling Off mode is on, the refrigerator chime sounds, and the refrigerator shows "0" on the fridge indicator and "FF" on the freezer indicator

SmartThings

Installation

Visit the Google Play Store, Galaxy Apps, or Apple App Store and search for "SmartThings".

Download and install the SmartThings app provided by Samsung Electronics to your smart device.

NOTE

- The SmartThings app is not available for some tablet and iPad and some smartphone.
 - Support that [Android] OS 6.0 or higher. (mimimum 2 GB RAM Size)
 - Support that [iOS] 10.0 or higher/iPhone 6 or higher.
- For improved performance, the SmartThings app is subject to change without notice or discontinued support according to the manufacturer's policy.
- Recommended encryption systems include WPA/TKIP and WPA2/AES. Any newer or non-standard Wi-Fi authentication protocols are not supported.
- Wireless networks may be affected by the surrounding wireless communication environment.
- If your Internet service provider has registered the MAC address of your PC or modem for identification, your Samsung Smart Refrigerator may fail to connect to the Internet. If this happens, contact your Internet service provider for technical assistance.
- The firewall settings of your network system may prevent your Samsung Smart Refrigerator from accessing the Internet. Contact your Internet service provider for technical assistance. If this symptom continues, contact a local Samsung service center or retailer.
- To configure the wireless access point (AP) settings, see the user manual of the AP router).
- Samsung Smart Refrigerators support both IEEE 802.11 b/g/n (2.4 GHz) and 802.11 a/n/ac (5 GHz) protocols. (IEEE 802.11 n and 802.11 ac are recommended.)

- Unauthorized Wi-Fi wireless routers may fail to connect to applicable Samsung Smart Refrigerators.

Samsung account

You are required to register your Samsung account to use the app. If you don't have a Samsung account, follow the app's onscreen instructions to create a free Samsung account.

Getting started

Turn on the device you want to connect, open the SmartThings app on your phone, and then follow the instructions below.

If a pop-up appears saying that a new device has been found, tap ADD NOW.

If a pop-up doesn't appear, tap the + button, and then select the device you want to connect from the list of available devices.

If your device isn't in the list of available devices, tap Supported Devices, select the device type (Refrigerator), and then select the specific device model.

Follow the instructions in the app to set up your device. Once setup is complete, your refrigerator will appear as a "card" on your Devices screen.

Refrigerator app

Integrated control

You can monitor and control your refrigerator at home and on the go.

- Tap the refrigerator icon on the SmartThings Dashboard or tap the Devices icon at the bottom of the Dashboard, and then tap the refrigerator "card" to open the Refrigerator page.
- Check the operation status or notifications related to your refrigerator, and then change options or settings if necessary.

NOTE

Some options or settings of the refrigerator may not be available for remote control.

Monitoring

Fridge temperature

- Displays the desired temperature setting of the fridge.

Freezer temperature

- Displays the desired temperature setting of the freezer.

Diagnosis

- Detects abnormal operations of the refrigerator.

Energy monitoring

- Checks the accumulated power consumption of the refrigerator for the last 180 days.

Functions

Ice making

- You can turn the ice making function on or off, and check the current settings of the function.
- You can also check the status and progress of ice making.

Power Cool

- You can turn Power Cool on or off, and check the current settings.

Power Freeze

- You can turn Power Freeze on or off, and check the current settings.

Fridge temperature

- You can change the desired setting temperature of Fridge.

Freezer temperature

- You can change the desired setting temperature of Freezer.

Sabbath Mode

- You can activate and deactivate the Sabbath mode.

Alarms

Abnormally high temperature

- This alarm is triggered when the fridge or freezer has abnormally high temperatures.

Door opening

- This alarm is triggered if the fridge door, the freezer drawer, or the FlexZone™ drawer is open for a specific length of time.

Water filter replacement

- This alarm reminds you that the water filter must be replaced.

SMART GRID Function (Demand Response)

When the refrigerator operates in SMART GRID (Demand Response) mode, the Energy Management Refrigerator function can control energy usage or delay the operation of some functions to save money when energy prices or demand are the highest.

NOTE

- You can deactivate the SMART GRID (Demand Response) function at any time using the Peak Demand Off function.
- To use the SMART GRID (Demand Response) function, you need a separate contract with your electric utility company.

In addition, to use the Smart Grid (Demand Response) function, you must register for the service with your electric company. The company must have an EMS (Energy Management System) that supports SEP (Smart Energy profile).

Using the SMART GRID (Demand Response) Function

This feature monitors energy prices and demand information from your utility company and sends notifications to the refrigerator to run high energy consuming tasks during off peak times when electricity costs and demand are lower.

If the refrigerator receives a control signal from the utility company, the refrigerator will display the DAL (L3) ~ TALR (L4) levels on the refrigerator display and control the power consumption according to the level.

[Exception condition] The DAL and TALR control signals from a utility company work as long as product performance is maintained.

If the refrigerator receives the SMART GRID (Demand Response) signal (DAL or TALR), the refrigerator will operate in Delay Appliance Load (Display:L3) or Temporary Appliance Load Reduction (Display:L4) mode.

- Delay Appliance Load (L3): The refrigerator responds to a DAL signal by providing a moderate load reduction for the duration of the delay period. This function controls functions that consume a lot of energy such as adjusting the Cooling system, running the defrost cycle, and making ice.
 - When the refrigerator operates in DAL (L3) mode, "L3" is displayed on the refrigerator display.
 - DAL mode is automatically deactivated after it lasts for the amount of time stipulated by the DAL signal (max. 4.5 hours) or when the Peak Demand Off key is pressed.
- Temporary Appliance Load Reduction (L4): The refrigerator responds to a TALR signal by aggressively reducing the load for a short time period. This function reduces energy consumption by stopping the compressor and controlling the functions that consume a lot of energy such as the defrost cycle and making ice.
 - When the refrigerator operates in TALR (L4) mode, "L4" is displayed on the refrigerator display.

- TALR (L4) mode is automatically deactivated after it lasts for the received duration max. 15 minutes), or when the Peak Demand Off key is pressed. The mode is immediately deactivated and the refrigerator returns to the normal state when the door is opened or closed, or the dispenser is used.

Peak Demand Off (Override mode)

When you want the refrigerator to ignore the SMART GRID (Demand Response) signal from the utility company, you can activate Peak Demand Off (Override mode).

When you activate Peak Demand Off (Override mode), the refrigerator ignores the SMART GRID (Demand Response) signal and is not controlled by the utility company.

Activating and deactivating Peak Demand Off (Override mode)



Display Type A

1. To activate/deactivate Peak Demand Off (Override mode), Press the <button for 3 seconds, while not changing other display settings.
2. When the Peak Demand Off function is deactivated, if you press< button for 3 seconds the Peak Demand Off function will be activated.
 - The corresponding indicator () turns on.

If the refrigerator receives a SMART GRID (Demand Response) signal from the utility company, 'Or' is displayed in the fridge indicator.

3. When the Peak Demand Off function is activated, if you press < button for 3 seconds the Peak Demand Off function will be deactivated.
 - The corresponding indicator () turns off.

Display Type B, Type C

1. To activate Peak Demand Off (Override mode), tap  until the Peak Demand indicator blinks.
2. Tap > to select the Peak Demand Off.
 - The corresponding indicator (Peak Demand Off) turns on.
 - If the refrigerator receives a SMART GRID (Demand Response) signal from the utility company, 'Or' is displayed in the fridge indicator.
3. To deactivate Peak Demand Off (Override mode), tap  until the Peak Demand indicator blinks.
4. Tap < to select the Peak Demand On.
 - The corresponding indicator (Peak Demand On) turns on.

Using the Energy Management Function

The Energy Management function enables you to control and monitor your Energy

Management refrigerator using the SmartThings app for your convenience.

NOTE

- To use the Energy Management refrigerator functions, you have to install the corresponding app first.

1. Operational Status

- You can check the DR and Peak Demand Off (Override mode) status.

2. Energy Consumption Reporting

- Shows the accumulated power consumption. Power consumption data is updated every 10 minutes.

NOTE

The energy consumption report may differ from the power consumption specifications of the product depending on the operating environment and the stored food.

3. Delay Defrost Capability

- The Delay Defrost Capability function saves energy by delaying the defrost operation to a time specified by the user. You can configure the time. and this function will save energy during the specified period in a 24 hour cycle. If the time is not set, the function works with the default time settings. The default time settings are below:
 - 6 am to 10 am: 1st. November ~ 30th. April
 - 3 pm to 7 pm: 1st. May ~ 31th. October

To change the time setting for the Delay Defrost Capability

You can change the time setting for the Delay Defrost Capability on the app.

Provision for Open Access to the Connected Product Requirements

1. SGIP Open Standards

- Energy Consumption Reporting
- Demand Response

2. Samsung OPEN API

- Operational Status, User Settings & Messages
- ICE Maker Status: GET /icemaker/status/vs/0
- Door Open Alarm: GET /doors/vs/0
- DR Status: GET /drlc/vs/0
- Delay Defrost Capability
- Set Schedule of the Defrost Delay: POST /defrost/reservation/vs/0?op=add
- Get Schedule of the Defrost Delay : GET /defrost/reservation/vs/0

- Delete Schedule of the Defrost Delay: POST /defrost/reservation/vs/0?op=remove
- Defrost Delay On/OFF: POST /defrost/delay/vs/0

Special features

Water dispenser

Using the dispenser, you can dispense water.

To dispense chilled water, turn off the Dispenser Lock function. Put a water glass under the dispenser, and then push the dispenser lever.

NOTE

- The dispenser will stop dispensing if you keep pushing the dispenser lever for about 1 minute. To dispense more water, release and push the lever again.
- Make sure the glass is in line with the dispenser to prevent the dispensed water from spilling out.
- If you do not use the water dispenser for 2-3 days, the dispensed water may have an abnormal smell or taste. This is not a system failure. Discard the first 1-2 glasses of water.

Water clouding

Water supplied to the refrigerator flows through a core alkaline filter. During this filtering process, the water pressure of the water increases and the water becomes saturated with oxygen and nitrogen. This causes the water to look misty or cloudy temporarily when dispensed. This is normal and the water will look clear after a few seconds.

Maintenance

Handling and care

Fridge shelves

1. Fully open the fridge door.
2. Hold the front of the shelf lift the back of the shelf to release the hook from the groove.

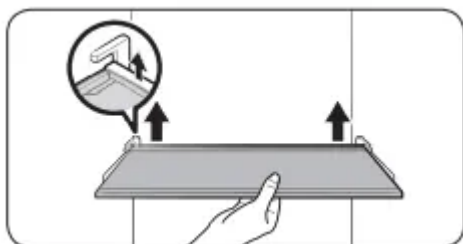

3. Hold the front and back of the shelf. Lift the back of the shelf, and then pull it out.

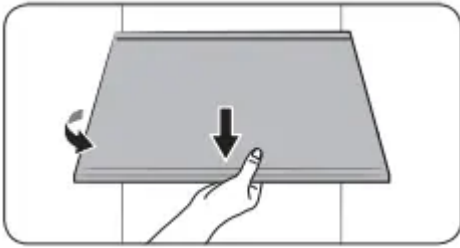

Vegetable shelves

1. Fully open the fridge door.
2. Lift up the front of the shelf and pull it to release the shelf from the holder at the rear wall.

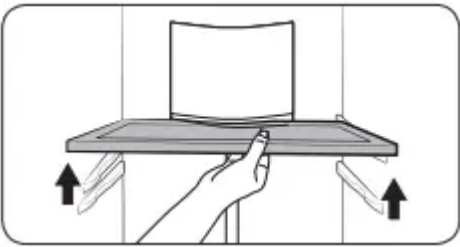

Door bins

- To remove the door bin, hold the front sides of the bin, and then gently lift up to remove.
- To reinsert, insert the door bin slightly above its final location making sure that the back of the bin is against the door. Hold the rear of the door bin with both hands, and then press down so that it fits snugly.

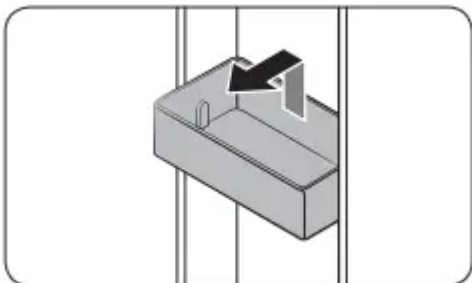

CAUTION

- Do not remove a bin that is filled with food. Empty the bin beforehand.
- Use caution when opening the door if the bottom bin contains larger bottles, which may fall over.
- Do not allow children to play with the bins. Sharp corners of the bin may cause injury.

Fridge drawers

Vegetable / fruit drawers

Gently lift up the front of the drawer and slide out.

- We recommend that you remove the door bins before removing the drawer. This is to prevent damage to the door bins.

- To reinsert, insert the drawer into the frame rails and then slide inward.

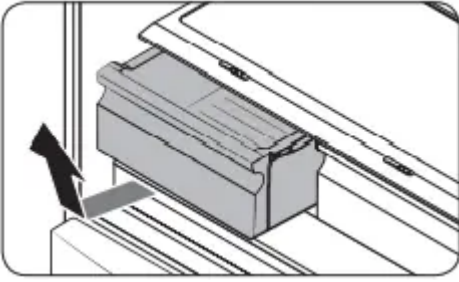

Freezer baskets

Lower ice bucket (applicable models only)

1. Fully open the freezer drawer.

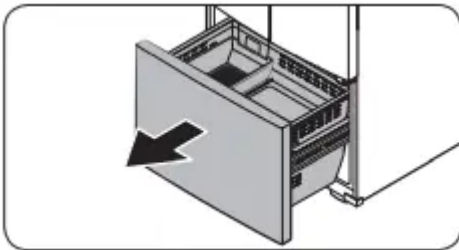

2. Lift the lower ice bucket to remove.

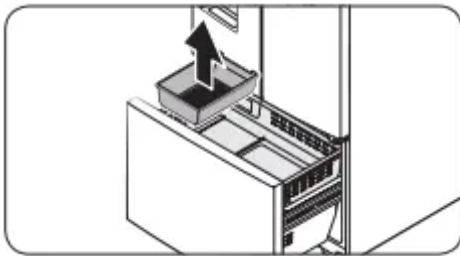

Upper basket

- To remove, fully slide open the freezer drawer. Lift up the front of the upper basket and pull to remove.
- To reinsert, align the front wheels of the upper basket with the end of the lower basket. Slide the upper basket to the front.

Lower basket

- To remove, first remove the upper basket. Then, tilt up the front of the lower basket to pull out.
- To reinsert, put the basket onto the rail assembly rear side first.

CAUTION

- Do not twist the basket when removing or reinserting the basket. The basket can be scratched.
- To prevent physical injury, property damage, or suffocation, keep children away from freezer baskets that have been removed.
- Do not remove the divider.
- Put the wheels of the upper basket on the end of the rails of the lower basket. Then, slide the upper basket all the way to the front. Otherwise, the drawer will not open or close properly, which will cause frost to build up.

Cleaning

Interior and exterior

Regularly use a dry cloth to remove all foreign substances such as dust or water from the power plug terminals and contact points.

1. Unplug the power cord.
2. Use a moistened, soft, lint-free cloth or paper towel to clean the refrigerator's interior and exterior.
3. When done, use a dry cloth or paper towel to dry well.
4. Plug in the power cord.

Rubber seals

If the rubber seals of a door become dirty, the door may not close properly and reducing refrigerator performance and efficiency. Use a mild detergent and damp cloth to clean the rubber seals. Then, dry well with a cloth.

Rear panel

To keep cords and exposed parts of the rear panel free of dirt, vacuum the panel once or twice a year.

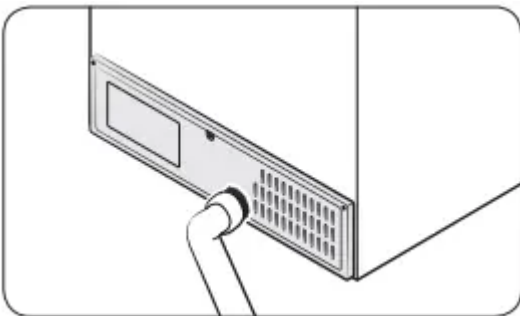

CAUTION

Do not remove the rear panel cover. Electric shock may occur.

Replacement

Water filter

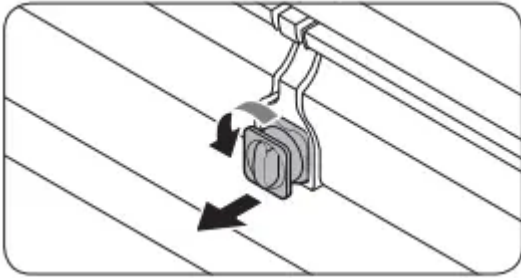

The Water Filter Indicator () turns red to let you know it is time to replace the water filter. Before replacing the filter, make sure the water supply line is shut off.

1. Shut off the water supply line.
2. Turn the knob of the filter cartridge 180 degrees counterclockwise (1/4 turn). The filter cartridge unlocks.

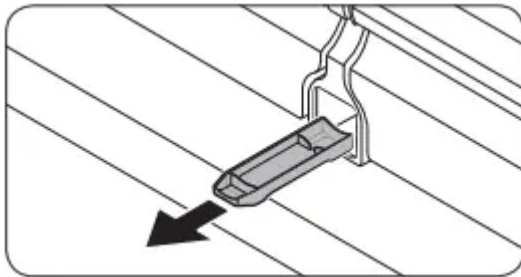

3. Pull out to remove the cartridge.
 - If the water filter is severely contaminated, the cartridge may not be easy to remove. If that is the case, use force to remove the cartridge.
 - To prevent water leaks from the filter opening, pull the cartridge straight out while removing it.
4. Insert a new filter cartridge. Use only Samsung-provided or approved filters.



5. Turn the cartridge knob clockwise to lock into place.
6. Tap  button until the Water Filter Indicator () blinks. And then tab < or > to turn on Reset and then tab  to confirm.
7. When you are done replacing the filter, open the water valve and run water through the dispenser for about 7 minutes. This is to remove impurities and air from the water line

Reverse osmosis water filtration system

The water pressure of the water supply system to a reverse osmosis water filtration system must be between 30 to 120 psi (206 to 827 kPa).

The water pressure of the reverse osmosis water filtration system to the refrigerator's cold water line must be at least 40 psi (276 kPa). If the water pressure is below these specifications:

- Check if the sediment filter in the reverse osmosis system is blocked. Replace the filter if necessary.
- Refill the water tank in the reverse osmosis system with water.
- If your refrigerator has a water filter, it may further reduce the water pressure when used in conjunction with a reverse osmosis system. Remove the water filter.

For more information or servicing, contact a licensed plumbing professional.

Ordering a new filter

To purchase a new water filter, contact a local Samsung service center or visit www.samsungparts.com on the web.

LED Lamps

To replace the lamps of the refrigerator, contact a local Samsung service center.

Troubleshooting

General

Temperature

Fridge/freezer does not operate. Fridge/freezer temperature is warm.

- Power cord is not plugged in properly.
 - Properly plug in the power cord.
- Temperature control is not set correctly.
 - Set the temperature lower.
- Refrigerator is located near a heat source or direct sunlight.
 - Keep the refrigerator away from direct sunlight or a heat source.
- Not enough clearance between refrigerator and nearby walls or cabinets.
 - Make sure there is a gap of at least 2.5 inches (5 cm) between the refrigerator back and sides and any nearby walls or cabinets.
- The refrigerator is overloaded. Food is blocking the refrigerator vents.
 - Do not overload the refrigerator. Do not allow food to block vents.

Fridge/freezer is over-cooling.

- Temperature control is not set correctly.
 - Set the temperature higher.

Interior wall is hot.

- Refrigerator has heat-proof piping in the interior wall.
 - To prevent condensation from forming, the refrigerator has heat-proof piping in the front corners. If the ambient temperature rises, this equipment may not work effectively. This is not a system failure.

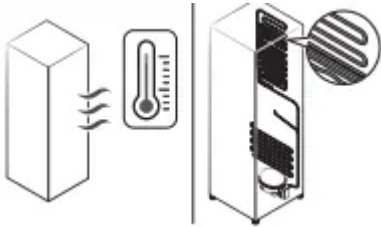

Odors

Refrigerator has odors.

- Spoiled food.
 - Clean the refrigerator and remove any spoiled food.
- Food with strong odors.
 - Make sure strong smelling food is wrapped airtight.

Frost

Frost around the vents.

- Food is blocking the vents.
 - Make sure no food blocks the refrigerator vents.

Frost on interior walls.

- Door is not closed properly.
 - Make sure food does not block the door. Clean the door gasket.

Fruits or vegetables are frozen.

- Fruits or vegetables are stored in the FlexZone™.
 - Do not store most kinds of fruit or vegetables in the FlexZone™.

Condensation

Condensation forms on the interior walls.

- If door is left open, moisture enters the refrigerator.
 - Remove the moisture and do not leave a door open for extended periods of time.

- Food with high moisture content.
 - Make sure food is wrapped airtight.

Water/ice (dispenser models only)

Water flow is weaker than normal.

- Water pressure is too low.
 - Make sure the water pressure is between 30 to 120 psi (206 to 827 kPa).

Ice maker makes a buzzing sound.

- The Ice Maker function is activated, but the water supply to the refrigerator has not been connected.
 - Press Ice Maker.

Ice maker does not make ice.

- Ice maker has just been installed. You must wait for 12 hours for the refrigerator to make ice.
 - Freezer temperature is too high. Set the freezer temperature below 0 °F (-18 °C) or -4 °F (-20 °C) in warm ambient air.
- Dispenser panel Lock is activated.
 - Deactivate dispenser panel Lock.
- Ice maker is off.
 - Turn on the ice maker.

Water does not dispense.

- Water line is not connected properly or water supply is not on.
 - Check if the water line is installed correctly. Check if the water line stop cock is



- Dispenser panel Lock is activated.
 - Deactivate dispenser panel Lock.
- A third-party water filter was installed.
 - Use only Samsung-provided or approved filters.
 - Unapproved filters may leak and damage the refrigerator.

- Water filter indicator turns on or blinks.
 - Replace the water filter. After replacing, reset the filter indicator sensor.

Do you hear abnormal sounds from the refrigerator?

Before calling for service, review the information below. If you still have questions about sounds your refrigerator is making, please call Samsung Customer Care at 1-800-SAMSUNG (726-7864). Note that you will be charged for any service visits related to normal operating sounds in which no defects were found.

These sounds are normal.

- When starting or ending an operation, the refrigerator may make sounds similar to a car engine ignition. As the operation stabilizes, the sounds will decrease.

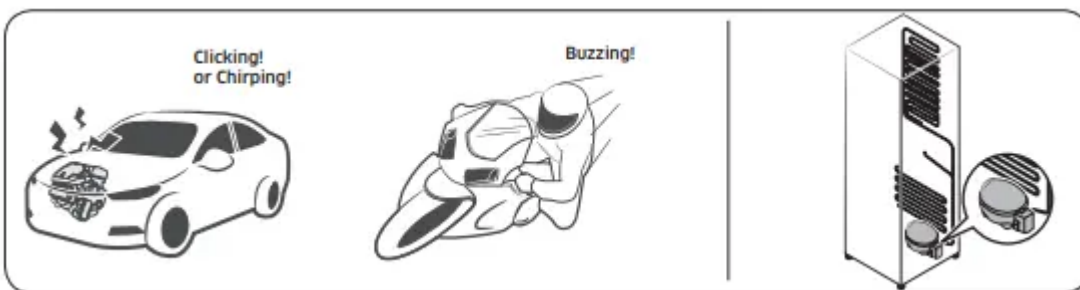

- While the fan is operating, these sounds may occur. When the refrigerator reaches the set temperature, the fan sound will stop.

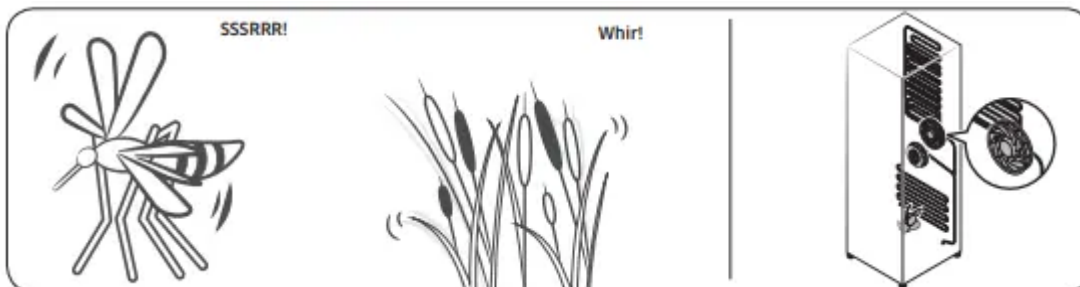

- During a defrost cycle, water may drip on the defrost heater, causing sizzling sounds.



- As the refrigerator cools or freezes, refrigerant gas moves through sealed pipes, causing bubbling sounds. Bubbling!

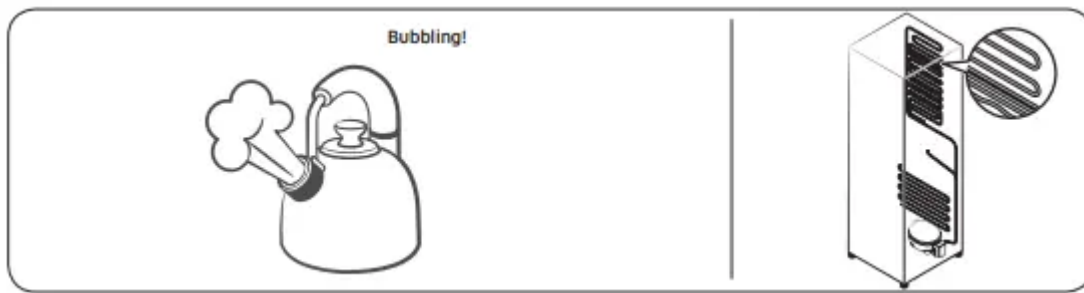

- As the refrigerator temperature increases or decreases, plastic parts contract and expand, creating knocking noises. These noises occur during the defrosting cycle or when electronic parts are working.

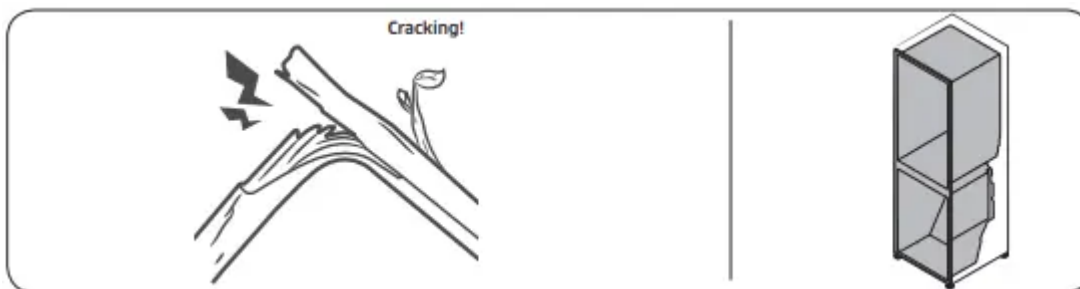

- For ice maker models: When the water valve opens to fill the ice maker, you may hear a buzzing sound.
- Due to pressure equalizing when you open and close the refrigerator door, you may hear a whooshing sound

SmartThings

Could not find "SmartThings" in the app market.

- The SmartThings app is not available for some tablet and iPad and some smartphone.
 - Support that [Android] OS 6.0 or higher. (mimumum 2 GB RAM Size)
 - Support that [iOS] 10.0 or higher/iPhone 6 or higher.

The SmartThings app fails to operate.

- The SmartThings app is available for applicable models only.
- The old Samsung Smart Refrigerator app cannot connect with Samsung Smart Home models.

The SmartThings app is installed but is not connected to my refrigerator.

- You must log into your Samsung account to use the app.
- Make sure that your router is operating normally.
- If you have not connected your refrigerator to the SmartThings App after the app was installed, you must make the connection using the device registration function of the app.

Could not log into the app.

- You must log into your Samsung account to use the app.
- If you don't have a Samsung account, follow the app's onscreen instructions to create one.

An error message appears when I try to register my refrigerator.

- Easy Connection may fail due to the distance from your access point (AP) or electrical interference from the surrounding environment. Wait a moment and try again.

The SmartThings app is successfully connected to my refrigerator but does not run.

- Exit and restart the SmartThings app or disconnect and reconnect the router.
- Unplug the power cord of the refrigerator, and then plug it in again after 1 minute.

Smart Grid

What Do I Need to use the Energy Management and Smart Grid functions?

- To use the Smart Grid (Demand Response) and Energy Management function on your Refrigerator, you need the following devices and apps:
 - Devices: 1) A Wireless Router, 2) A SmartThings Refrigerator, 3) A Smartphone. (Recommended: Android OS 8.0 or later version)
 - Applications: 1) "SmartThings App" from the Google Play Store.

You also need to:

- Connect the Refrigerator and the Smartphone to the same Wi-Fi network in your home.
- Install and run the SmartThings App on your Smartphone.
- In addition, to use the Smart Grid (Demand Response) function, you must Register for the service with your electric company. The company must have an EMS (Energy Management System) that supports SEP (Smart Energy profile).

Why isn't the Energy Management function working normally?

- Confirm that the router in your home and the internet are working properly.
 - Connect a Smartphone to the router (AP, Access Point), and then confirm that you can browse the Internet on the phone.
- Confirm that refrigerator is connected to the AP.
 - Check for Wi-Fi icon on the panel of the refrigerator. If the refrigerator is connected, the icon will be on.
- Confirm that the refrigerator and Smartphone are connected to the same router.

Why isn't the Delay Defrost Capability working normally?

- Confirm that the router in your home and the Internet are working properly.
- Connect a Smartphone to the router (AP, Access Point), and then confirm that you can browse the Internet on the phone.
- Confirm that the rear where you live is properly entered into the SmartThings App.
- Confirm that the Smart Grid function works correctly. (Check the control panel. The DAL or TALR icon should not be displayed on the panel.)

Warning

This content is compiled from multiple sources and is provided for reference purposes only. It may not be complete or fully applicable to all situations. If you are unable to resolve your issue, please contact the product manufacturer or an authorized service provider for official support.