

User manual Dishwasher

USING THE DISHWASHER

Getting started

Features and appearance will vary throughout this manual

GDF565



GDF645

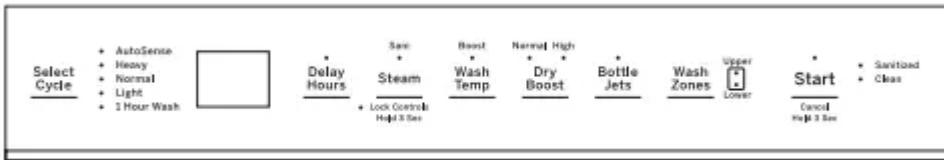

GDT565

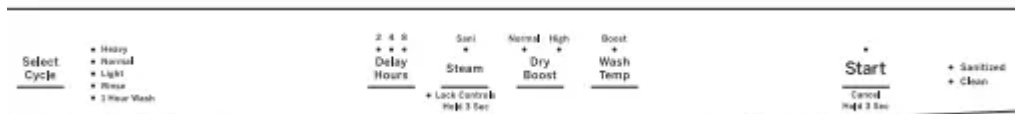

DD*700

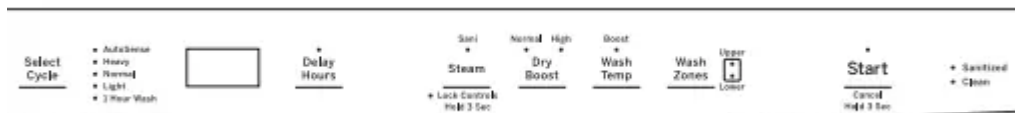

GD*665, GD*645

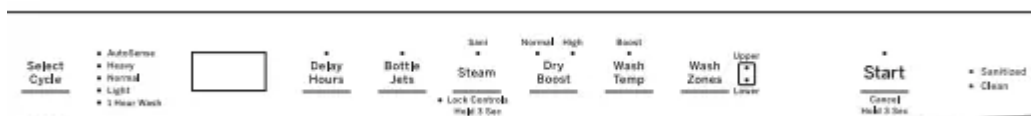

PD*715

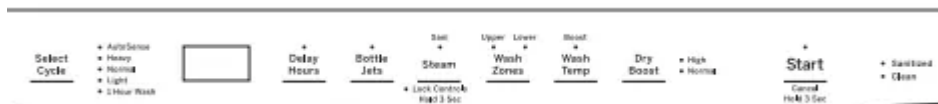

PD*755

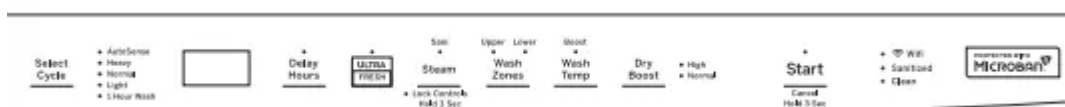

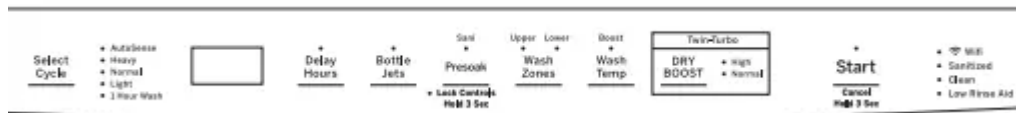

Leak Protection (on some models)

If a leak is detected, the dishwasher will drain and the cycle will stop. The display will show “LEAK DETECTED”. Contact us for service.

1. Load Dishwasher

For best dishwashing results, follow the loading guidelines found in the Loading section. No pre-rinsing of normal food soil is required. Scrape off hard soils, including bones, toothpicks, skins, and seeds. Remove leafy vegetables, meat trimmings, and excessive amounts of grease or oil.

2. Add Detergent

Add needed amount of detergent to the detergent dispenser. Use high quality detergents such as Cascade® Platinum™ ActionPacs™ or Finish® Quantum® Automatic Dishwashing Detergent. See Dispensers section.

3. Add Rinse Agent

Add high quality rinse agents such as Cascade® Platinum™ Power Dry™ Rinse Aid or Finish® Jet-Dry® Rinse Aid to the rinse agent dispenser. See Dispensers section. NOTE: The use of rinse aid can further enhance the dishwasher’s drying performance.

4. Select Cycle

Press the furthest pad on the left for the desired wash cycle. On some models, the light next to the furthest pad on the left will be lit to indicate which wash cycle has been selected. On other models, pressing the furthest pad on the left will show various cycles in the display window. Press the pad until the desired cycle is shown.

NOTE: Actual cycle times vary based on soil level, water temperature, and options selected.

The cycle may be selected with the door in the open position. The cycle will not start until the Start pad is pushed and the door is closed within 4 seconds.

AutoSense/ Auto (on some models) This cycle automatically senses the soil level and adjusts the wash cycle accordingly. *Time 1 hour 50 minutes - 2 hours 10 minutes

Heavy/ Pots This cycle is meant for heavily soiled dishes, cookware, pots, or pans with dried-on or baked-on soils. Everyday dishes are safe to be used in this cycle * Time: 2 hours 31 minutes



Normal This cycle is meant for daily, regular, or typical use to completely wash a full load of normally soiled dishes and is designed to conserve both water and energy *Time: 1 hour 15 minutes - 1 hour 50 minutes

NOTE: Normal was used to rate the energy efficiency of this dishwasher.

Light/ China This cycle is for light to medium soiled dishes. It is safe for china and crystal with no options selected. *Time: 55 minutes

Rinse (on some models) For rinsing partial loads that will be washed later. Do not use detergent. Detergent is not dispensed during the rinse cycle. *Time: 16 minutes

1-Hour Wash This cycle will quickly wash lightly soiled dishes *Time: 60 minutes For better drying, select Dry Boost. This will raise the final rinse temperature and extend the dry time. Dry Boost will add 49 to 90 minutes to the cycle time. When the Clean light comes on, open the door, pull the racks out, and the dishes will “flash” dry in approximately five minutes.

ULTRA FRESH (on some models) When this option is selected, the UltraFresh smart algorithm works continuously to help reduce odors to ensure your dishwasher stays fresh and clean. When enabled, the dishwasher door fan, water valve, and drain pump may operate at certain intervals prior to or following a cycle.

UltraFresh System™ Dishwasher with Microban® Antimicrobial Technology (on some models)

The UltraFresh smart algorithm works continuously to help reduce odors to ensure your dishwasher stays fresh and clean. The UltraFresh System™ Dishwasher with Microban® Antimicrobial Technology includes multiple components which are manufactured with Microban® anti-microbial technology.** Microban® is a safe and effective antimicrobial technology. For more information, please visit www.microban.com/geappliances. UltraFresh can be selected at any time. Pressing the ULTRAFRESH pad will activate the system and will illuminate the LED just above the ULTRAFRESH pad. The UltraFresh feature may be turned off at any time by pressing the ULTRAFRESH pad a second time.

While UltraFresh is activated, outside of the dishwasher cycle, the Dry Boost™ with Fan Assist-Dry may run at specific intervals regardless if the door is open or closed. Additionally, when the dishwasher door is closed, the dishwasher may add and drain water at specific intervals. You may see water in the bottom of the dishwasher or hear the drain pump outside of the dishwasher cycle.

5. Select Options

The light by the selected pad will be lit to indicate which Option has been selected.

Normal Temp

This option is for normally soiled dishes, optimizes wash performance while conserving energy.

Boost

This option increases the temperature to help clean heavily soiled dishes and will increase the cycle time by 20 to 50 minutes. Option may be turned On or Off during the wash cycle. This option will also improve dry performance on the Normal cycle.

Steam-Sani, PresoakSani, or Sanitize

This option raises the water temperature in the final rinse to sanitize your dishware but may increase cycle time by 60 minutes. The cycle length will vary depending on the temperature of your inlet water.

NOTE: This option is monitored for sanitization requirements. If the cycle is interrupted during or after the main wash portion or if the incoming water temperature is so low that adequate water heating cannot be achieved, the sanitizing conditions may not be met. In these cases, the Sanitized or Cycle Sanitized light will not illuminate at the end of the cycle. Utilizing this option will modify the cycle to meet the requirements of Section 6, of the NSF 184 Standard for soil removal and sanitization efficacy.

NOTE: Certified residential dishwashers are not intended for licensed food establishments.

Dry Boost Off

Shuts off the drying option. Dishes air dry naturally and energy is saved. Open the dishwasher door to speed drying.

Dry Boost Normal

Turns on the option for faster drying. This option may add up to 64 minutes to the cycle time. On models with the hidden heater feature, this option boosts the temperature of the dishwasher during the final rinse portion of the cycle then utilizes a fan to circulate air to dry the dishes. This very efficient fan may run for an additional 90 minutes after the cycle is complete to maximize drying performance. Fan operation will end if the door is opened during this 90 minute period. This option is not available with the Rinse cycle.

Dry Boost High (on some models)

This option can be selected by pressing the Dry Boost pad twice to illuminate the High light. It will add additional time to your drying option, further enhancing the dishwasher's performance for difficult to dry items.

Wash Zones (on some models)

Selecting either the Upper or Lower Wash Zones will target dishwashing of just one rack. This will shorten the cycle time and conserve energy. This option should be used when dishes are placed in only one rack.

Bottle Jets (on some models)

This option increases the time that the bottle jets are on and may add up to 23 minutes to the cycle time. Use this to wash difficult to clean, dishwasher safe baby bottles, sport bottles, tall coffee cups, etc. See use recommendations in the Loading section.

Delay Hours

Delays the start of a wash cycle up to 8 to 12 hours depending on model. Press Delay Hours, to select the number of hours, then press Start one time and close door to begin countdown. The cycle will start once allotted time has expired.

Lock Controls

You can lock the controls to prevent selections from being made. You can also lock the controls after you have started a cycle to prevent cycle changes. For example, children cannot accidentally start the dishwasher by pressing pads with this option selected.

To LOCK/UNLOCK the dishwasher control, depending on the model, press and hold the Dry Boost pad, or the Steam-Sani/Presoak-Sani/Sanitize pads at the same time, for 3 seconds. The Lock Controls light will turn on to indicate the control is locked and will turn off to indicate the control is unlocked.

6. Start Dishwasher

Start

Press the Start pad and close the door within 4 seconds to start the cycle or begin the Delay Hours countdown. The wash cycle will begin shortly after closing the door. The display will turn off if the door remains open for two minutes. To activate the display, close and open the door or press any pad.

Interrupt or Pause

To interrupt or pause a dish cycle, slowly open the door. Opening the door will cause the wash cycle to pause. The dishwasher will beep every minute to remind you to close the door. To restart or resume the cycle, press Start, and close the door within 4 seconds.

Cancel

To cancel a wash cycle, press and hold the Start pad for 3 seconds and close door. The dishwasher will drain, emit a beep sound, and the wash cycle light will turn OFF.

7. Cycle Indicator Lights and Sounds

Sanitized

Displayed at end of the cycle when Wash Temp Sani or Sanitize Temp has been selected and dishwasher has met requirements for sanitization. See Wash Temp Sani or Sanitize Temp, for complete description. Closing door or pressing any pad will turn off light.

Clean

Displayed when a wash cycle is complete. The light stays ON as a reminder that the dishes are clean. The light will turn off when the door is opened.

Cycle Status (on some models)

The indicator light on the door front will change color to indicate the wash status. During the wash cycle, the indicator light will be amber. When the wash cycle is complete, the light will change to white.

Sounds

The dishwasher will emit a sound to indicate cycle completion, pad presses, and door ajar.

Mute

To turn the dishwasher control sounds ON/OFF, press the Dry Boost pad 5 times within 5 seconds.

Sabbath/ Door Wake Up Mode (on some models)

To turn this option ON/OFF, press and hold the Cycle Select and Wash Temp Boost pads for 5 seconds, close the door and wait 3 minutes for the dishwasher to go into sleep mode. In the OFF mode, the control display, control sounds, and interior lights (on some models) will not respond to the door opening/closing. This mode can be used when observing certain religious holidays such as the Sabbath. To activate the control and interior lights (on some models), press any pad.

Dispensers

Check the Water Temperature

The entering water should be at least 120°F (49°C) and not more than 150°F (66°C) for effective cleaning and to prevent dish damage. Check the water temperature with a candy or meat thermometer.

Turn on the hot water faucet nearest the dishwasher, place the thermometer in a glass and let the water run continuously into the glass until the temperature stops rising.

Use a Rinse Agent

High quality rinse agents such as Cascade® Platinum™ Power Dry™ Rinse Aid or Finish® Jet-Dry® Rinse Aid are designed for great drying action and to protect against spots and film build-up on your dishes, glasses, flatware, cookware, and plastic.

Filling the Rinse Agent Dispenser

The rinse agent dispenser holds 3.5 oz. (104 ml) of rinse agent. Under normal conditions, this will last approximately one month.

1. Make sure the dishwasher door is fully open.
2. Open the rinse agent dispenser door.

3. Slowly add rinse agent until the cup is full. You may need to pause several times to allow rinse aid to settle. NOTE: Indicator window does not light up.
4. Clean up any spilled rinse agent with a damp cloth to prevent foam from forming inside the dishwasher.
5. Close the rinse agent dispenser door.

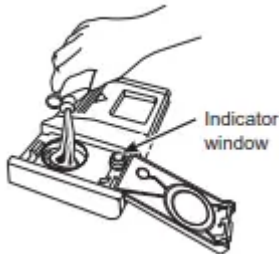

Rinse Aid Setting

The amount of rinse agent released into the final wash can be adjusted. If water drops or hard water spots remain on dishes after the dry cycle, increase the setting.

To adjust the setting

Open the Rinse Agent dispenser door; then turn the adjuster clockwise to increase the amount of rinse agent, counterclockwise to reduce the amount of rinse agent.

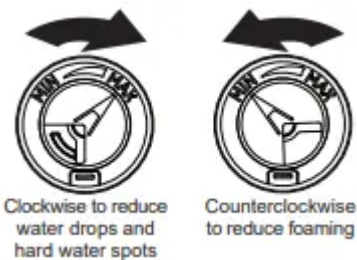

Detergent Dispenser

The detergent dispenser is located in the center of the dishwasher door. It has two compartments. The main wash compartment is found inside the detergent dispenser. To open, press the button on the side of the dispenser. The pre-wash compartment is on the lid of the detergent dispenser. Use the pre-wash compartment only when your water is extremely hard or when you have a heavy soiled load. The pre-wash compartment is not used when tablet or packet detergents are used.

NOTE: Do not block detergent dispenser with large or tall dishware.

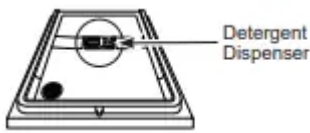

You may use tablet, packet, powder, liquid or gel automatic dishwasher detergent. Make sure you use only detergents specifically labeled for use in automatic dishwashers. Never use liquid hand dish detergent in an automatic dishwasher. Sudsing and poor wash performance will result with the use of improper detergents.

Detergents should be stored in a dry location and in their original container to prevent loss of effectiveness. Place detergent in the cup just prior to starting the dishwasher and then close the cover. The cover will open during the wash cycle.

Filling the Detergent Dispenser

GE Appliances recommends using high quality detergent in tablet or packet form. Independent testing has shown this form of detergent is very effective in the dishwasher. Cascade® Platinum™ ActionPacs™ or Finish® Quantum® Powerball® are examples of this type of detergent. However, some single dose detergents are not designed for shorter cycles. If you experience wash-out issues with these tablets or packets, follow the instructions below:

Rinsing cycles - DO NOT use detergents. (These cycles are designed for rinsing dishes only, not soil removal.)

Washing cycles less than 60 minutes (not including additional dry or wash options) - Put a tablet or packet into the pre-wash compartment of the detergent cup, or in the bottom of the dishwasher. (These cycles are designed to be shorter which could result in bad detergent wash-out if the detergent is placed in the main wash compartment of the detergent cup. Wash performance will be diminished as a result.)

Washing cycles 60 minutes or longer (not including additional dry or wash options) - Put a tablet or packet into the main wash compartment of the detergent cup and close the detergent cup cover. (These cycles are designed for tougher soils and will likely have more fills/drains than the shorter cycles. If the tablet or packet is placed in the pre-wash compartment or tossed in the bottom of the dishwasher, the detergent will be flushed down the drain in a very short period of time and will thus be wasted. Wash performance will be very poor as a result.) If you choose to use detergent in powder, liquid or gel form, the amount of detergent you use will be determined by the hardness of your water, the temperature of your water, and the food soil load inside the dishwasher. Contact your water company to get information about the hardness of the water in your area. Water hardness is measured in grains per gallon. Use this information and the table above to determine the amount of detergent to use. You may purchase a hard water test strip from GE Appliances. Call 877-959-8688 and ask for part number WD01X10295. In Canada, call 800-661-1616.

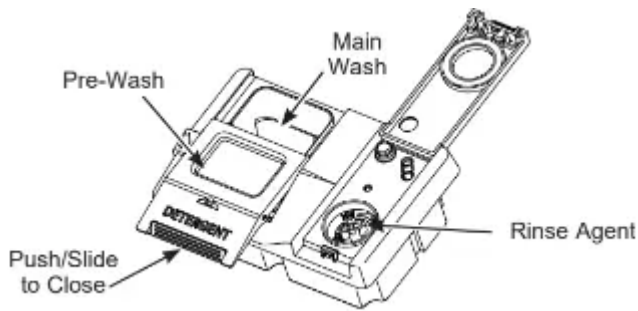

Use the table as a starting point and then adjust the amount of detergent you use. Use just enough to get good wash performance. Using just the right amount of detergent will provide great wash performance without wasting detergent or etching glassware.

Number of Grains/Gal.	Detergent Cup(s) to Fill
Less than 4	Fill cup to 1/3 full
4 to 8	Fill cup to 2/3 full
8 to 12	Fill cup completely full
Greater than 12	Fill both main wash cup and pre-wash cup

Using too much detergent with very soft and/or very hot water may cause a condition called etching on your glassware. Etching is a permanent cloudiness in your glassware. This condition is irreversible. However, using too little detergent will cause poor wash performance.

DO NOT USE HAND DISH DETERGENT



NOTE: Using a detergent that is not specifically designed for dishwashers will cause the dishwasher to fill with suds. During operation, these suds will spill out of the dishwasher vents, covering the kitchen floor and making the floor wet.

Because so many detergent containers look alike, store the dishwasher detergent in a separate space from all other cleaners. Show anyone who may use the dishwasher the correct detergent and where it is stored.

While there will be no lasting damage to the dishwasher, your dishes will not get clean using a dishwashing detergent that is not formulated for automatic dishwashers.

Appliance Communication

WiFi Connect (on some models) (for customers in the United States)

Your dishwasher is GE Appliances WiFi Connect capable. A WiFi communication card is built into the product allowing it to communicate with your smartphone for remote monitoring, control and notifications.



This device complies with Part 15 of the FCC Rules. Operation is subject to the following two conditions:

1. This device may not cause harmful interference, and
2. This device must accept any interference received, including interference that may cause undesired operation. This equipment has been tested and found to comply with the limits for a Class B digital device, pursuant to Part 15 of the FCC Rules. These limits are designed to provide reasonable protection against harmful interference in a residential installation. This equipment generates uses and can radiate radio frequency energy and, if not installed and used in accordance with the instructions, may cause harmful interference to radio communications. However, there is no guarantee that interference will not occur in a particular installation. If this equipment does cause harmful interference to radio or television reception, which can be determined by turning the equipment off and on, the user is encouraged to try to correct the interference by one or more of the following measures:

- Reorient or relocate the receiving antenna.
- Increase the separation between the equipment and receiver.
- Connect the equipment into an outlet on a circuit different from that to which the receiver is connected
- Consult the dealer or an experienced radio/television technician for help.

Labelling: Changes or modifications to this unit not expressly approved by the manufacturer could void the user's authority to operate the eq

Loading

For best dishwashing results, follow these loading guidelines. Features and appearance of racks and silverware baskets may vary from your model.

Upper Rack

The upper rack is primarily for glasses, cups, and saucers. For best wash performance, tilt cup and glass openings toward the center of the rack. Other items such as pots, pans, and plates may be placed in the upper rack. This is also a secure place for dishwasher-safe plastic items. The upper rack can be used for odd sized utensils. Sauce pans, mixing bowls, and other similarly shaped items should be placed face down for best wash performance. Ensure small plastic items are secure so that they cannot fall on the heater at the bottom of the dishwasher, potentially damaging the item. Some models are equipped with a hidden heater, so dishwasher safe plastic items can be placed in the lower rack.

IMPORTANT: Ensure items in the upper rack do not interfere with the 3rd Rack (on some models) when loading and unloading.

IMPORTANT: Ensure that items do not protrude through the bottom of the rack or silverware basket where they will block the rotation of the middle spray arm. This could result in noise during operation and/or poor wash performance.

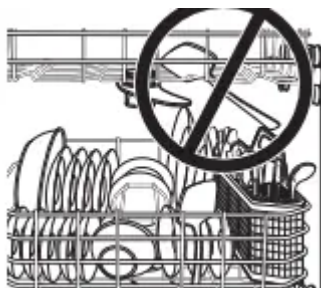

The Bottle Jets system (on some models) is the ideal location to position baby bottles, tall sports bottles, or other tall items with narrow openings. The Bottle Jets clips hold bottles with small openings in place so water jets are directed inside the bottles to clean hard to reach areas. Clips can be installed or removed by simply slipping the clip opening over the top of the nozzle.

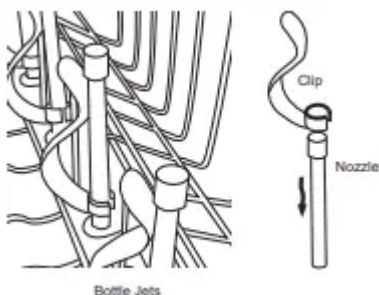

Sports bottle held in place over a Bottle Jets clip



Baby bottle held in place under a Bottle Jets clip

The upper rack allows 2" of adjustment up or down to accommodate large items. The upper rack may be lowered by pushing the long flaps on each side of the rack. This will allow you to lower the rack (see fig. Upper Rack). To raise the rack, lift up on the rack until the rack locks in place.

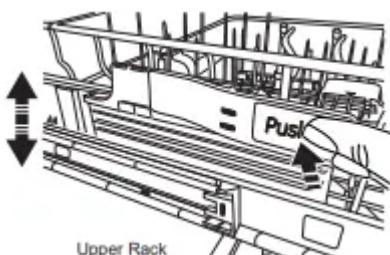

On some models, the upper rack may be adjusted to accommodate larger items. To adjust the upper rack, fully extend the upper rack and lift the front of the rack so that the rack roller wheels

clear the end hooks on the front of the rails. Continue to pull the rack until the remaining rack roller wheels clear the end hook. Select the set of rollers on the side of the rack that provides the desired height, and reinstall the upper rack by aligning the rack roller wheels on the end hook and rack rails – Ensure that there are roller wheels above and below the rack rails. Failure to properly align the wheels onto the end hook and rails may result in the rack falling from the dishwasher.

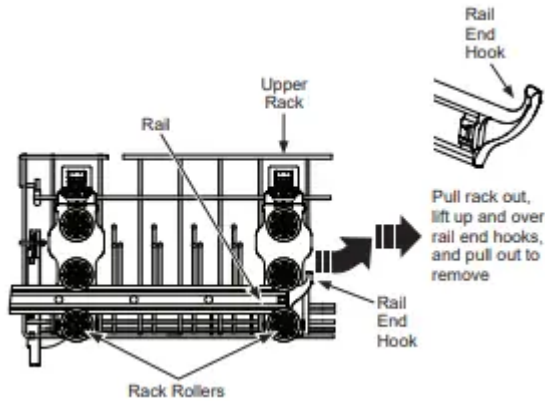

To add flexibility in loading, the stem safe shelf (on some models) may be placed in the up or down position or unfolded and placed in the lower unfolded position.

The shelf may also be used to secure stemware such as wine glasses. Because these stemware items come in various sizes, slowly push the rack in to ensure the items do not bump into the edges of the dishwasher, which may cause damage to the items.

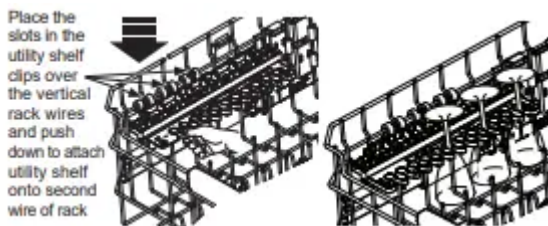

The fold down tines (on some models) provide flexibility for extra-large and hard-to-fit items. The tine rows can be adjusted to a vertical or lay-down position.



For best dishwashing results, follow these loading guidelines. Features and appearance of racks and silverware baskets may vary from your model.

8 Place Settings - Upper Rack

Models - GD*565, GD*645, GD*665, DD*700, PD*715, PD*755, PD*775, PD*785

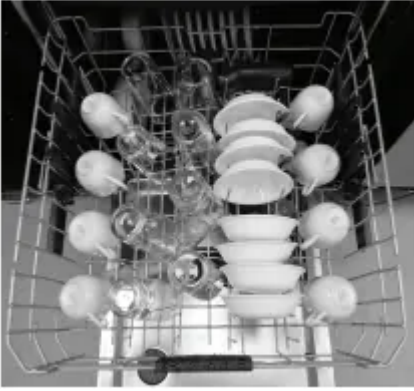

10 Place Settings - Upper Rack

Models - GD*565, GD*645, GD*665, DD*700, PD*715, PD*755, PD*775, PD*785

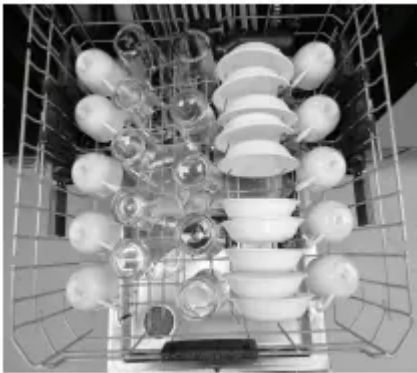

12 Place Settings - Upper Rack

Models - GD*645, GD*565, PD*775



Models - DD*700, GD*665, PD*715, PD*755



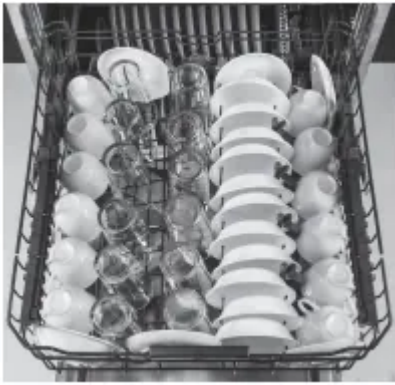

Models - PD*785



Lower Rack

The lower rack is best used for plates, saucers and cookware items. Large items, such as broiler pans and baking racks should be placed along the sides of the rack. If necessary, oversized glasses and mugs can be placed in the lower rack to maximize loading flexibility. Plates, saucers and similar items should be placed between the tines in the direction that allows the item to remain secure in the rack.

NOTE: Do not load large items in the lower rack where they may block the wash jets from rinsing out the detergent dispenser.

The lower rack fold down tines (on some models) can be adjusted to different upright angles or placed flat to provide flexibility for hard-to-fit or extra-large items.

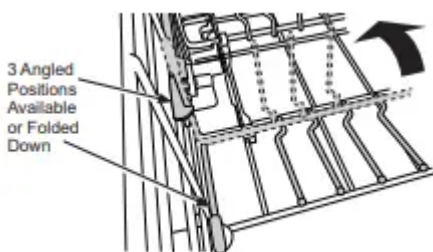

To change the direction of the fold down tines, lower the tines, then pull away from the bar clips that secure the tines to the rack and remove. Reverse the direction of the tines, orienting the handle on the opposite side of the rack. Reattach the tines to the bar clips by pushing the tines back until they click in place. The indexer will also need to be switched to the opposite side of the

dishwasher. To remove the indexer, simply slide it in the direction labeled “unlock.” Then, align the indexer with the rack on the other side and slide in the direction that says “lock” in order to reattach the indexer to the rack.

IMPORTANT: It is important to ensure that items do not protrude through the bottom of the rack or the silverware basket where they will block the rotation of the lower spray arm. Also, ensure that large plates, pots, or tall items don't hit the mid spray arm. This could result in noise during operation and/or poor wash performance.

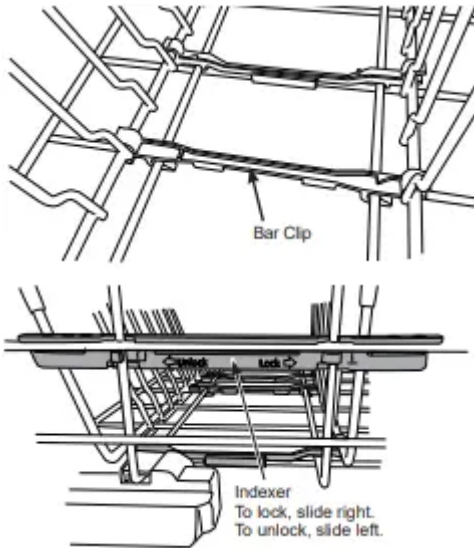

8 Place Settings - Lower Rack

Models - GD*565, GD*645, GD*665

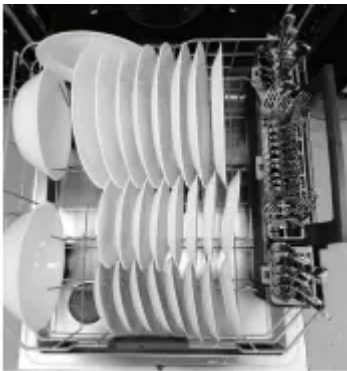

Models - DD*700, PD*715, PD*755, PD*775, PD*785

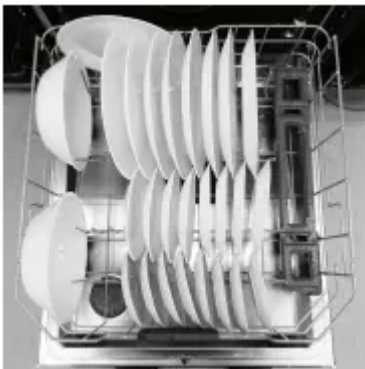

10 Place Settings - Lower Rack

Models - GD*565, GD*645, GD*665

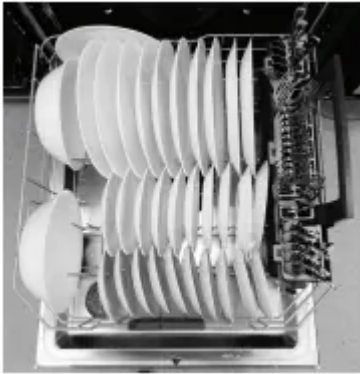

Models - DD*700, PD*715, PD*755, PD*775, PD*785

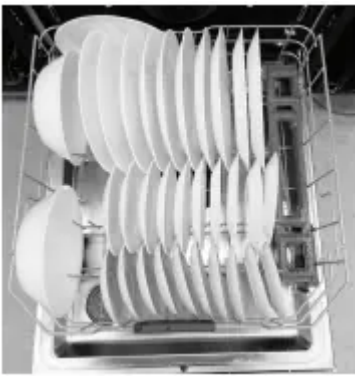

12 Place Settings - Lower Rack

Models - GD*645, GD*565, PD*775

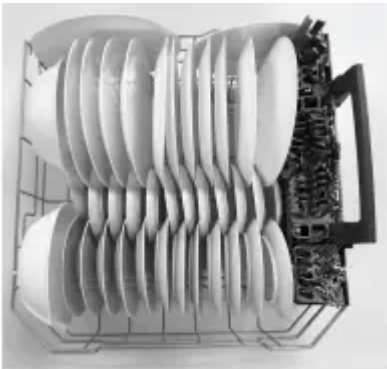

Models - DD*700, GD*665, PD*715, PD*755, PD*785



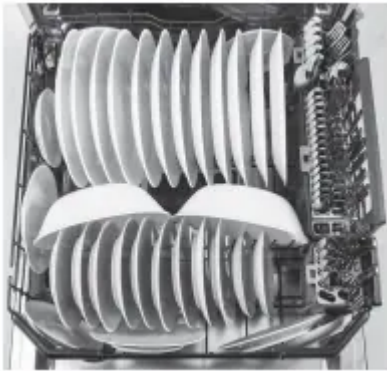

3rd Rack (on some models)

The 3rd rack is the recommended location for silverware and large utensils.

IMPORTANT NOTES:

- Do not allow cutlery of different materials to touch each other in the 3rd rack. Doing so may cause discoloration of the cutlery.
- The tray is only meant to be used with a GE Appliances 3rd rack dishwasher to hold silverware, cooking utensils, and other small items. Using the tray for any other purpose could result in damage to the tray or damage to anything interacting with the tray.
- Ensure that the 3rd rack is fully closed before shutting the dishwasher door. Shutting the door with the rack partially extended could cause damage to the dishwasher.



The 3rd rack is also removable to allow extra large items to be placed in the upper rack:

To remove the 3rd rack:

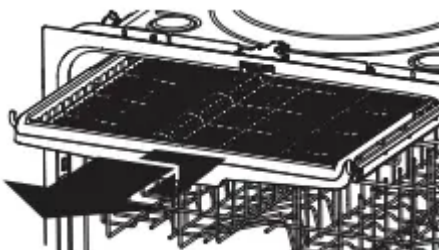

1. With the rack fully extended, lift the front of the rack so that the rack roller wheels clear the retaining hook.
2. Continue to pull the rack until the remaining rack roller wheels clear the retaining hook.

3. Replace the rack by aligning the rack roller wheels on the retaining hook and rack rails – Ensure all roller wheels are located on top of the rack rails.

Silverware Basket

Place flatware in the removable silverware baskets. Sharp objects, such as forks and knives, may be placed with the handles facing up, in order to protect your hands. For the best wash performance, place other items such as spoons with the handles facing down. Avoid allowing items to nest together, which may keep them from being properly washed. When loading, distribute items evenly in the basket.

The silverware baskets may also be used for small items, such as measuring spoons, baby bottle nipples, plastic lids, or corn cob holders. The silverware basket covers can be closed to contain small items.

IMPORTANT: Do not load large or tall utensils where they may block the detergent dispenser, mid spray arm, or become trapped between the door and the gasket when the door is closed.



Deep Clean Silverware Jets (on some models)

Deep Clean Silverware Jets target stubborn, stuck-on food and help separate nested spoons and forks to keep your silverware spotless no matter how you load the silverware. For optimal silverware cleaning, the use of silverware basket lids is always recommended. For models with the third rack, the Deep Clean Silverware Jets can also be used to clean mixing bowls and other cookware.

Do not remove Deep Clean Silverware Jet spray assembly from the dishwasher rack.

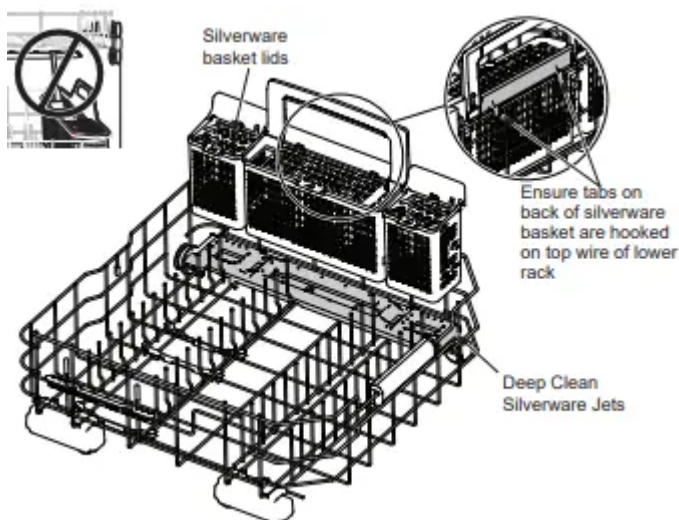

Silverware Basket - 8 Place Settings

Models - GD*565, GD*645



Silverware Basket - 10 Place Settings

Models - GD*565, GD*645



Silverware Basket - 12 Place Settings

Models - GD*565, GD*645



Silverware Basket - 8 Place Settings

Models - GD*665, DD*700, PD*715, PD*755, PD*775, PD*785

NOTE: Refer to the 3rd Rack in this Loading The Dishwasher section.

Silverware Basket - 10 Place Settings

Models - GD*665, DD*700, PD*715, PD*755, PD*775, PD*785

NOTE: Refer to the 3rd Rack in this Loading The Dishwasher section.

Silverware Basket - 12 Place Settings

Models - GD*665, DD*700, PD*715, PD*755, PD*775, PD*785



Care and cleaning

Control Panel

To clean the control panel, use a lightly dampened cloth.

Then dry thoroughly.

Exterior Door Panel

Before cleaning the front panel, make sure you know what type of panel you have. Refer to the last two letters of your model number. You can locate your model number on the left-hand tub wall just inside the door. If your model number ends with BB, CC, DS, D1, ES, FS, SA, TS, WW or W2 then you have a painted door panel. If your model number ends with SS or S1, then you have a Stainless Steel door panel. If your model number ends with II, then you have an Integrated door panel.

Follow the instructions below for cleaning the door panel for your specific model.

Painted/Coated Door Panel (model numbers ending in BB or D1-black, CC-bisque, DS-black slate, ES-slate, FS-fingerprint resistant, SA-silver, TS-black stainless steel, or WW or W2-white)

Use a clean, soft, lightly dampened cloth, then dry thoroughly.

Stainless Steel Door Panel (model numbers ending in SS or S1)

For cleaning rust and tarnish, cleaners with oxalic acid such as Bar Keepers Friend Soft Cleanser™ will remove rust, tarnish and small blemishes. Use only a liquid cleanser free of grit and rub in the direction of the brush lines with a damp soft sponge. Do not use appliance wax or polish on the stainless steel.

For other blemishes and marks, use Stainless Steel Magic or a similar product using a clean soft cloth. Do not use appliance wax, polish, bleach or products containing chlorine on Stainless Steel. You can order Stainless Steel Magic #WX10X29 through GE Appliances Parts by calling 877.959.8688. In Canada, call 1-800-661-1616.

Integrated Door Panel (model numbers ending in II) This is a custom installed door panel, and you will need to refer to the cabinet manufacturers recommendations for proper cleaning.

Dishwasher Interior

To clean and de-odorize your dishwasher, use citric acid, or Cascade® Platinum™ Dishwasher Cleaner or Finish® Dishwasher Cleaner, a detergent additive. They will break up mineral deposits, and remove hard water film and stains. You can order citric acid GE Appliances kit #WD35X151 through GE Appliances Parts by calling 877-959-8688. In Canada, call 1-800-661-1616. You can purchase dishwasher cleaners at your local grocery store.

Stainless Steel Inner Door and Tub

The stainless steel used to make the dishwasher tub and inner door provides the highest reliability available in a GE Appliances dishwasher. If the dishwasher tub or inner door should be scratched or dented during normal use, they will not rust or corrode. These surface blemishes will not affect their function or durability.

Filters

Inspect and clean the filters periodically. This should be done every other month or more depending on usage. If there is a decrease in wash performance or dishes feel gritty, this is also an indication the filters need to be cleaned.

Ultra-Fine Filter Assembly

To clean the Ultra-Fine Filter assembly, remove the bottom rack. Twist the Ultra-Fine Filter assembly counterclockwise and lift to remove for cleaning. Rinse filter with warm soapy water and use a sponge to carefully remove any stubborn particles.

For models with a 2-piece Ultra-Fine Filter assembly with an additional Filter Basket for food particles, twist the Filter Basket in the counterclockwise direction to unlock it from the Ultra-Fine Filter assembly. See directional arrows on the bottom of the Filter Basket. Pull the Filter Basket to remove from the assembly, throw away any food particles, rinse with warm soapy water, and use a sponge to remove any stubborn particles.

2-piece - Ultra-fine Filter assembly with additional Filter Basket (on some models)

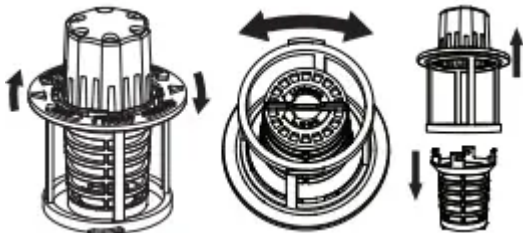

Once cleaned, replace Filter Basket back into the Ultra-Fine Filter assembly and twist it clockwise to lock into place.

Fine Filter

To clean the Fine Filter (mesh plate), remove the bottom rack. Remove the Ultra-Fine Filter.

Lift the Fine Filter up and out from under the two rear retaining tabs. Rinse filter with warm soapy water. Scouring pads or brushes can scratch the filter surface but a soft brush or sponge may be needed to remove stubborn soils or calcium deposits caused by hard water. Once cleaned, replace the Fine Filter making sure it goes under the two rear retaining tabs. Replace the Ultra-Fine Filter.

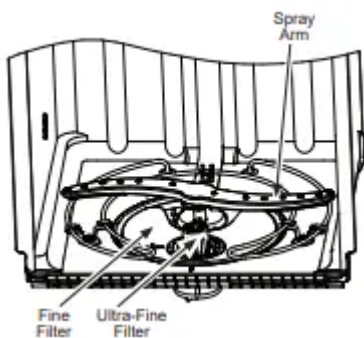

Protect Against Freezing

If your dishwasher is left in an unheated place during the winter, ask a service technician to:

1. Turn off electrical power to the dishwasher. Remove fuses or trip circuit breaker.
2. Turn off the water supply and disconnect the water inlet line from the water valve.
3. Drain water from the water inlet line and water valve. (Use a pan to catch the water.)
4. Reconnect the water inlet line to the water valve.

Does Your Dishwasher Have an Air Gap?

An air gap protects your dishwasher against water backing up into it if a drain clogs. The air gap is not a part of the dishwasher. It is not covered by your warranty. Not all plumbing codes require air gaps, so you may not have one.



The air gap is easy to clean.

1. Turn off the dishwasher and lift off the air gap cover.
2. Remove the plastic cap under the cover and clean with a toothpick.
3. Replace the cap and cover when the air gap is clean.

Troubleshooting Tips

Start status indicator light flashing

- The door was opened or the cycle was interrupted.

Press the Start pad once and close the door within 4 seconds to start the dishwasher. Press the Start pad a second time when the dishwasher is running only if you wish to cancel the cycle.

Dishwasher BEEPS once every minute

- This is a reminder that your dishwasher door has been left open during operation. It will continue beeping until you press Start and close the door.

Press Start and close the door.

Display shows “LEAK DETECTED”

- Possible leak is detected

Some models are equipped with leak detection and the cycle will be cancelled if a leak is detected. The display will show “LEAK DETECTED”. Contact us for service.

Beeping at the end of the cycle (on some models)

- This is normal. Dishwasher will beep twice at the end of the cycle.

To turn off the double beep indicator (or re-activate it if it was previously turned off), press the Dry Boost pad 5 times within 3 seconds. A triple beep will sound to indicate the end-of-cycle beep option has been turned on or off.

Dishes and flatware not clean

- Ultra-Fine Filter or Fine Filter is clogged

See the Care and Cleaning section.

- Low inlet water temperature

Make sure inlet water temperature is correct (see the USING THE DISHWASHER section). Turn on the hot water faucet nearest the dishwasher, let run until the water temperature stops rising. Then start the dishwasher and turn off the faucet. This ensures the entering water is hot. Select Boost if available.

- Water pressure is temporarily low

Turn on a faucet. Is water coming out more slowly than usual? If so, wait until pressure is normal before using your dishwasher. Normal water pressure to the dishwasher should be 20-120 psi.

- Air gap or disposer clogged

Clean the air gap or flush the disposer.

- High drain loop or air gap not installed

Refer to the Installation Instructions for proper drain line installation.

- Improper rack loading

Make sure large dishware does not block the detergent dispenser or the wash arms. See the Loading section.

- Poor performing detergent

Use high quality detergents such as Cascade® Platinum™ ActionPacs™ or Finish® Quantum® Automatic Dishwashing Detergent.

Spots and filming on glasses and flatware

- Extremely hard water

Use high quality rinse agents such as Cascade® Platinum™ Power Dry™ Rinse Aid or Finish® Jet-Dry® Rinse Aid to prevent spots and prevent new film build-up. If water is extremely hard, a softener may be required.

- Low inlet water temperature

Make sure water temperature is at least 120°F (49°C).

- Overloading or improper loading of the dishwasher

Load dishwasher as shown in the Loading section.

- Old or damp powder detergent

Make sure detergent is fresh. Use high quality detergents such as Cascade® Platinum™ ActionPacs™ or Finish® Quantum® Automatic Dishwashing Detergent.

- Rinse agent dispenser empty

Refill with high quality rinse agents such as Cascade® Platinum™ Power Dry™ Rinse Aid or Finish® Jet-Dry® Rinse Aid.

- Too little or low performing detergent

Make sure you use the proper amount of highly rated detergent.

Cloudiness on glassware

- Combination of soft water and too much detergent

This is called etching and is permanent. To prevent this from happening, use less detergent if you have soft water. Wash glassware in the shortest cycle that will get it clean.

- Low performing phosphatefree detergent

See A white film on glassware, dishware and the interior in this TROUBLESHOOTING section.

- Water temperature entering the dishwasher exceeds 150°F

This could be etching. Lower the water heater temperature.

Slight odor coming from unit during dry portion of cycle

- This is normal when the Dry Boost option is used for the first time. It is caused by the heating of new parts and will disappear in a short time.

No action is required.

Suds in the tub

- Wrong detergent

Use only high quality automatic dishwasher detergents to avoid sudsing. Cascade® Platinum™ ActionPacs™ or Finish® Quantum® Automatic Dishwashing Detergent have been approved for use in all GE Appliances dishwashers. To remove suds from the tub, open the dishwasher and let suds dissipate. Open the door, press and hold Start for 3 seconds, and close the door.

- Rinse agent was spilled

Always wipe up rinse agent spills immediately.

Detergent left in dispenser cups

- Dishes or utensils are blocking the detergent cup

Reposition the dishes, so the water from the lower spray arm can flush the detergent cup. See the Loading section.

Reposition the tall utensils or heavy silverware that may be keeping the dispenser cup door from opening. See the Loading section.

Don't place large bowls or pots directly under the detergent dispenser

Black or gray marks on dishes

- Aluminum utensils have rubbed against dishes

Remove marks with a mild, abrasive cleaner.

Dishes don't dry

- Low inlet water temperature

Make sure inlet water temperature is at least 120°F. Select Boost Dry.

Use Boost option.

Select a higher cycle, such as Steam-Sani, PresoakSani, or Sanitize.

- Rinse agent dispenser is empty

Check the rinse agent dispenser and fill as required.

- Additional drying time is needed

Leave door closed after the Clean light appears to allow the fan to run an additional 90 minutes. Note: If you open the door, this fan extension will be cancelled.

Control panel responded to inputs but dishwasher never filled with water

- Door may not be completely closed

Make sure the door is firmly closed.

- Water valve may be turned off

Make sure water valve (usually located under the sink) is turned on.

- Flood float may be stuck

Remove Ultra-Fine filter and lightly tap the piece under the ultra fine filter that looks like a salt shaker. Replace the filter

Stained tub interior

- White film on inside surface— hard water minerals

GE Appliances recommends high quality rinse agents such as Cascade® Platinum™ Power Dry™ Rinse Aid or Finish® Jet-Dry® Rinse Aid to help prevent hard water mineral deposits from forming.

Run dishwasher with citric acid to remove mineral deposits. Citric acid (Part number: WD35X151) can be ordered through GE Appliances Parts. See back cover for ordering information. Alternatively, purchase Cascade® Platinum™ Dishwasher Cleaner or Finish® Dishwasher Cleaner and follow the directions on the label.

Dishwasher won't run

- Fuse is blown or circuit breaker is tripped

Replace fuse or reset circuit breaker. Remove any other appliances from the circuit.

- Power is turned off

In some installations, the power to the dishwasher is provided through a wall switch, often located next to the disposer switch. Make sure it is on.

- Control panel is locked

Unlock control panel. See the Getting started section.

- Possible leak is detected

Some models are equipped with leak detection and the cycle will be cancelled if a leak is detected. The display will show "LEAK DETECTED". Contact us for service.

- Proper Start sequence was not followed

See the Using the dishwasher section.

Control panel lights go off when you're setting controls

- Time too long between touching of selected pads

Each pad must be touched within 30 seconds of the others. To relight, touch any pad again or open the door and unlock (top control).

Water standing in the bottom of the tub

- Air gap is clogged

Clean the air gap. See the Care and Cleaning section.

- High drain loop or air gap not installed

Refer to the Installation Instructions for proper drain line installation.

Water won't pump out of the tub

- Drain is clogged

If you have an air gap, clean it. See the Care and Cleaning section.

If the dishwasher drains into a disposer, run disposer clear.

Check to see if your kitchen sink is draining well. If not, you may need a plumber.

Steam

- This is normal

Warm, moist air comes through the vent during drying and when water is being pumped out. This is necessary for drying.

Sanitized or Cycle Sanitized light does not illuminate at the end of the cycle

- The door was opened and the cycle was interrupted during final rinse

Do not interrupt the cycle by opening the door during the wash cycle.

- The incoming water temperature was too low

Raise the water heater temperature to between 120°F and 150°F

Noise

- Normal operating sounds: Beeping at the end of the cycle (on some models), Detergent cup opening, Water entering dishwasher, Motor stops and starts at various times during cycle, Spray arms start and stop at various times, Drain pump sounds during pump out, Drain pump starts and stops several times during each drain

These are all normal. No action is required.

- Rattling dishes when the spray arm rotates

Make sure dishes are properly loaded. See the Loading section.

- Rattling silverware against door during wash

Tall utensils may be placed in the upper rack to avoid bumping against inner door during wash cycle.

A white film on glassware, dishware and the interior

- This problem is likely caused by a low quality phosphatefree dishwasher detergent

To remove the white film, run your dishes through a dishwasher cycle with citric acid. Use a WD35X151 citric acid kit found online. Otherwise, use high quality rinse agents such as Cascade® Platinum™ Dishwasher Cleaner or Finish® Dishwasher Cleaner found at your local grocery store.

Pour the citric acid in the detergent cup and close the cover. Place the filmed but otherwise clean glassware and dishware in the dishwasher. Leave silverware and other metal items out of the dishwasher. Turn the dishwasher on and let it run through a complete cycle without detergent. The glassware, dishware, and dishwasher should come out film free. Alternatively, a vinegar rinse may be used. Pour 1 cup of vinegar into dishwasher just after the detergent cup opens and let the dishwasher complete its

cycle. This may be repeated several times a year as needed. The use of high quality rinse agents such as Cascade® Platinum™ Power Dry™ Rinse Aid or Finish® Jet-Dry® Rinse Aid may help minimize a repeat build up of film. Also, the use of high quality detergents such as Cascade® Platinum™ ActionPacs™ or Finish® Quantum® Automatic Dishwashing Detergent will help prevent film build-up.

Feel air on your legs when standing in front of the dishwasher in cycle.

- This is normal

Do not interrupt the cycle. No action is required.

Warning

This content is compiled from multiple sources and is provided for reference purposes only. It may not be complete or fully applicable to all situations. If you are unable to resolve your issue, please contact the product manufacturer or an authorized service provider for official support.