

What's included

Make sure all the parts are included in the product package. If you have a question about the washer or the parts, contact a local Samsung customer center or your retailer.

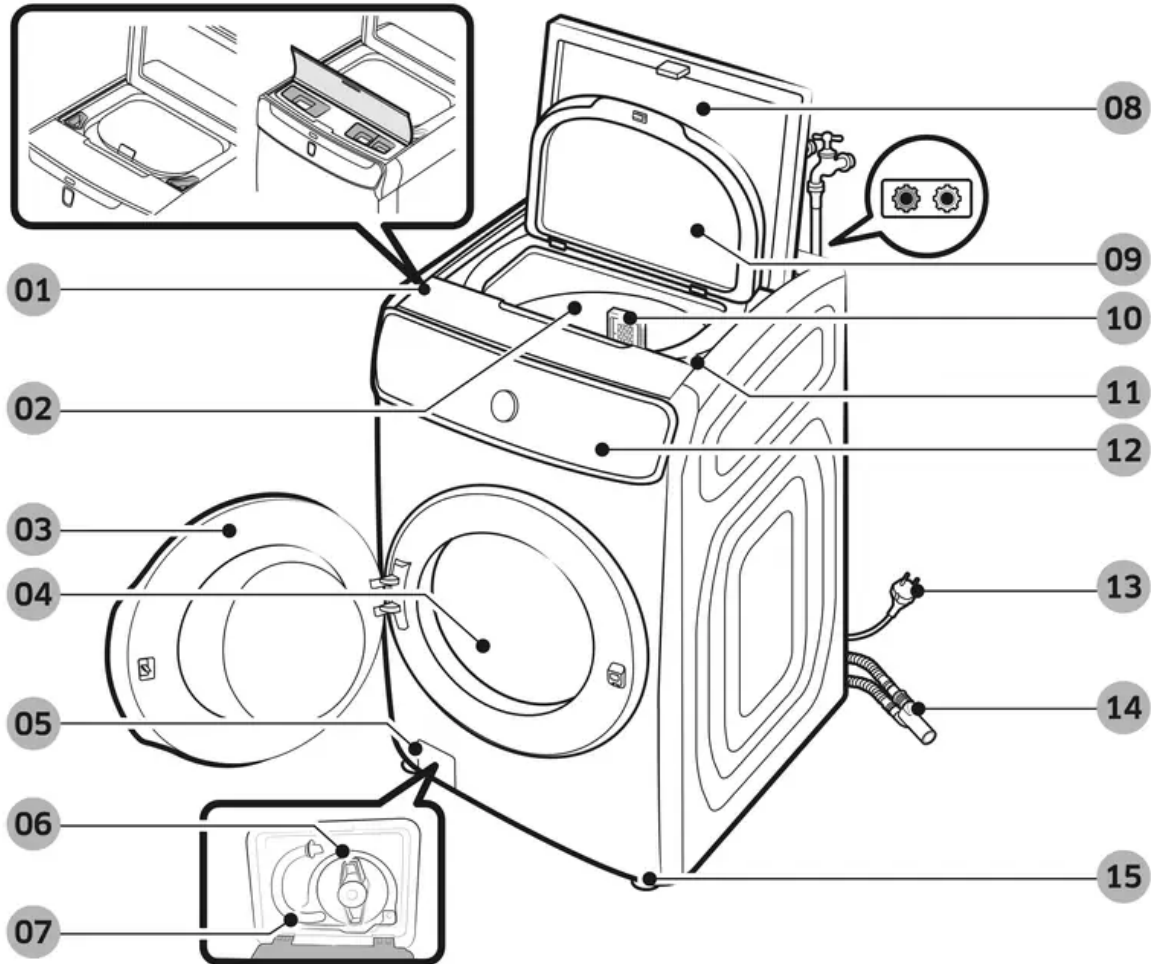

01. Lower detergent compartment
02. Tub
03. Front door
04. Drum
05. Filter cover
06. Pump filter
07. Emergency drain tube
08. Top door
09. Protective cover (inner)
10. Lint filter

11. Upper detergent compartment
12. Control panel
13. Power plug
14. Pipe connector (Upper drain hose & lower drain hose)
15. Leveling legs





Operations

Your dual loading washer features upper and the lower washers for your convenience. The upper washer is an automatic tub loader that is designed to wash relatively small loads while the lower washer is a drum loader that takes care of normal or relatively heavy loads.

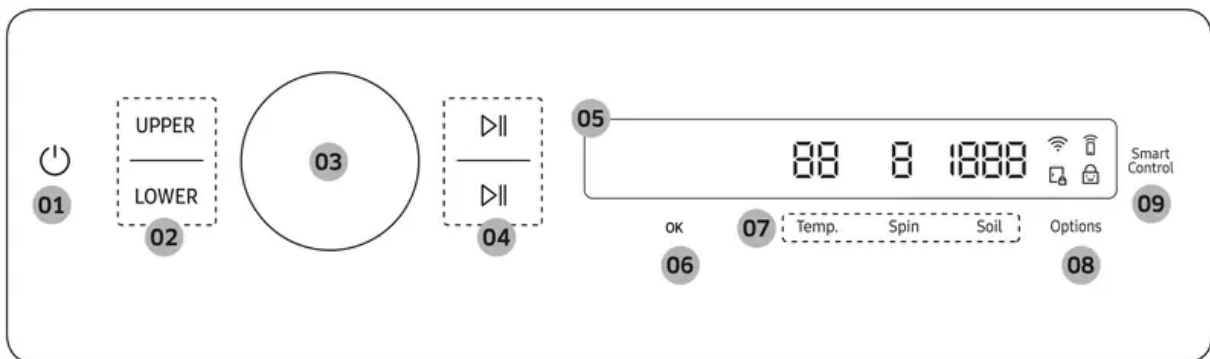



WARNING: To reduce the risk of fire, electric shock, or injury to persons, read the IMPORTANT SAFETY INSTRUCTIONS before operating this washer.

Control panel





| | |
|--|---|
| <p>01 Power </p> | <p>Tap to turn the washer on or off.</p> <ul style="list-style-type: none"> If you do not manipulate the control panel for 10 minutes after turning on the washer, the washer automatically turns off. The washer automatically turns off when the cycle completes. <p>⚠ CAUTION</p> <p>Do not tap  to turn off the power while the cycle is in progress. Tap  to pause the cycle first, and then tap  to turn off the power.</p> |
| <p>02 UPPER / LOWER</p> | <p>Tap UPPER to select the upper washer and use its features.</p> <ul style="list-style-type: none"> You can tap and hold UPPER for 3 seconds to cancel the upper washer operation. <p>Tap LOWER to select the lower washer and use its features.</p> <ul style="list-style-type: none"> You can tap and hold LOWER for 3 seconds to cancel the lower washer operation. |
| <p>03 Navigation dial</p> | <p>Turn the navigation dial left or right to navigate through cycles and functions. Your selection (such as cycle, additional functions, and system functions) is displayed on the LCD as you turn the navigation dial.</p> |
| <p>04 Start/Pause </p> | <p>You can start or pause the operation.</p> <ul style="list-style-type: none"> The upper button controls the upper washer, and the lower button controls the lower washer. Tap and hold the button to start the operation. During the operation, tap the button to pause. |
| <p>05 Display</p> | <p>The display shows current cycle information and estimated time remaining, or an information message when a problem occurs.</p> |
| <p>06 OK</p> | <p>Tap to confirm your selection of function or setting.</p> <ul style="list-style-type: none"> The button is inactive when the selected function or setting is not supported. |
| <p>07 Wash cycle settings</p> | <p>Tap the desired button to change the default wash cycle settings.</p> <ul style="list-style-type: none"> Temp.: Tap to change the water temperature for the selected cycle. Spin: Tap to change the spin speed for the selected cycle. <ul style="list-style-type: none"> Drain & No Spin: The drum does not spin after the final drain process. Rinse Hold & No Spin (All indicators are off): The final rinse process is suspended so that the laundry remains in the water. To unload the laundry, run a drain or spin process. Soil: Tap to change the soil level for the current cycle. |
| <p>08 Options</p> | <p>Tap to enter the Options menu. Tap and hold for 3 seconds to enter the System Functions menu.</p> |
| <p>09 Smart Control</p> | <p>Tap to activate or deactivate the Smart Control function. Tap and hold to enter pairing mode to connect to the SmartThings app.</p> <ul style="list-style-type: none"> When the Smart Control function is activated, you can control your washer remotely using the SmartThings app on your smartphone or tablet (Android or iOS). When you tap the button, the Smart Control function activates on both the upper and lower washers. |

Icon descriptions

| | | |
|---|----------------------|--|
|  | Wi-Fi | <ul style="list-style-type: none"> This icon indicates that the washer is connected to Wi-Fi. |
|  | Door Lock | <ul style="list-style-type: none"> This icon indicates the door is locked and cannot be opened. The door locks automatically during a cycle and this indicator turns on. You can open the door when this icon disappears. |
|  | Smart Control | <ul style="list-style-type: none"> This icon indicates that the washer's Smart Control is on. For more information on Smart Control, see page 56. |
|  | Child Lock | <ul style="list-style-type: none"> This icon indicates that Child Lock is on. For more information on Child Lock, see page 53. |

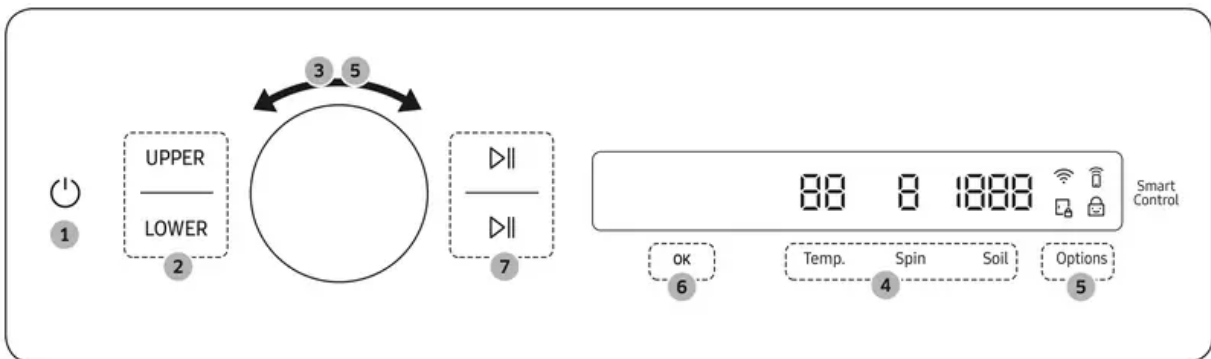
Operating a cycle



1. Tap  to turn the power on.
2. Tap UPPER or LOWER.
Tap UPPER to select the upper washer and use its features.
Tap LOWER to select the lower washer and use its features.
3. Turn the Navigation dial to select the cycle you want.
For more information on Cycle overview, see page 45.
4. Change the default cycle options.
Tap Temp., Spin, or Soil to change the default cycle settings.
5. Tap Options, and then turn the Navigation dial to select the desired additional function.
For more information on Options, see page 51.
6. Tap OK to change the settings for selected additional function.
Not all cycles have additional functions available.
7. Tap and hold  to start operation.
Once you set the cycle you want, the screen displays a brief cycle description, and cycle time. You can also check the cycle progress, remaining cycle time, and information codes.

To change the cycle during operation

1. Tap  of the upper or lower washer to stop the operation temporarily.

2. Turn the Navigation dial to select a different cycle.
3. Tap and hold  of the upper or lower washer to start the new cycle.

WARNING

- Do not put anything on top of your washer while it is running.
- While the lower washer is operating, the protective cover may have wet steam due to the temperature difference between the upper and lower parts of the washer.

CAUTION

- When using the upper washer, you may not see all the remaining clothes after a cycle is finished, especially those in the front area of the tub.
- When the cycle is complete, turn the tub manually to check if there are any clothes remaining in the tub.

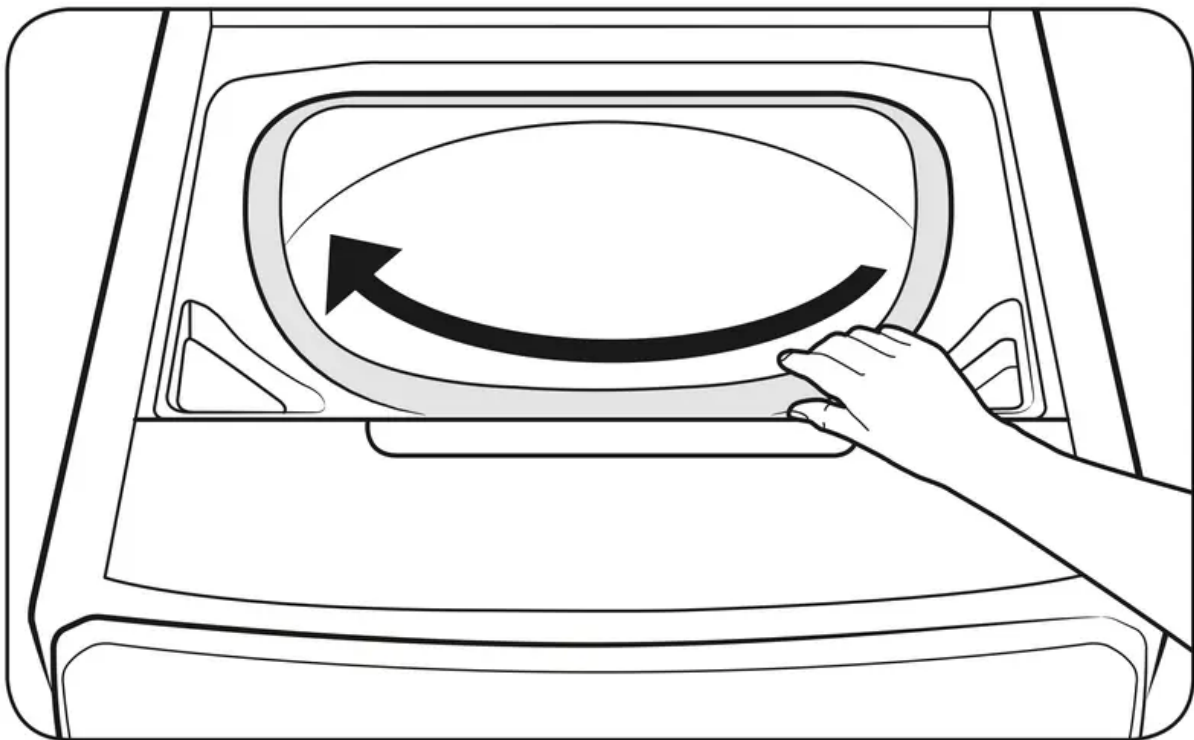

CAUTION: When using the upper washer, do not use a delicates bag featuring a protective plastic rim. Otherwise, the net may cause a system failure.

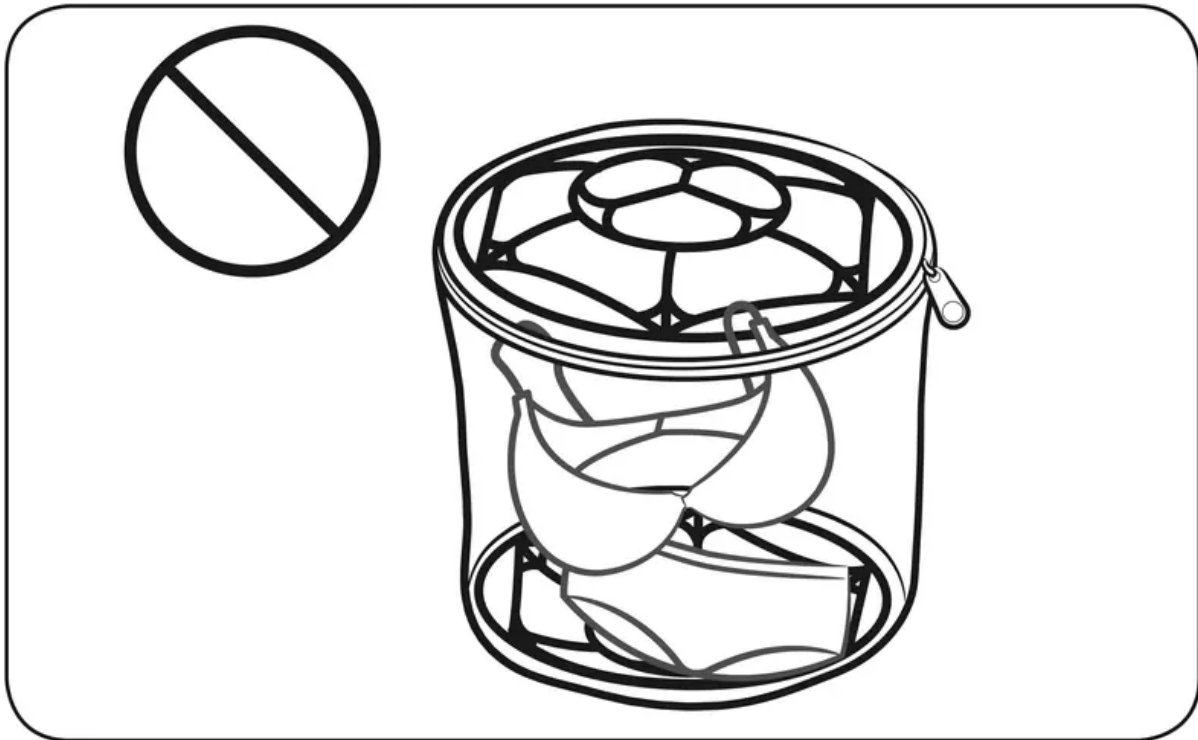

Cycle overview

Cycle descriptions

You can add or delete cycles to personalize the cycle list in the My Cycles option. See page 52 for more information.

Upper washer

| Cycle | Description |
|-------------------|---|
| Normal | <ul style="list-style-type: none"> For lightly soiled cotton, t-shirts, towels, and mixed loads. Use to wash lightly soiled normal items, except delicate fabrics such as silk or handwash-only fabrics. |
| Delicates | <ul style="list-style-type: none"> For sheer fabrics, bras, lingerie, silks, and other handwash-only fabrics. For best results, use liquid detergent. |
| Activewear | <ul style="list-style-type: none"> For exercise wear such as training pants, shirts/tops, and other performance clothing. This cycle provides effective soil removal with controlled tub rotation for special fabric care. |
| Self Clean | <ul style="list-style-type: none"> Cleans the tub by removing dirt. Perform once every 20 washes. Make sure the tub is empty. |
| Rinse+Spin | <ul style="list-style-type: none"> Features an additional rinse process after fabric softener is applied to the laundry. |
| Spin Only | <ul style="list-style-type: none"> To perform the spin process only. |

Lower washer

| Cycle | Description |
|-----------------------|--|
| Normal | <ul style="list-style-type: none"> For cottons, bed linens, table linens, underwear, towels, or shirts. The washing time and the rinse count are automatically adjusted according to the load. |
| Heavy Duty | <ul style="list-style-type: none"> For sturdy, colorfast fabrics and heavily soiled items. |
| Super Speed | <ul style="list-style-type: none"> Normal cycle with the Super Speed option. The shortened time may differ depending on the load/options. |
| Small Load | <ul style="list-style-type: none"> For lightly soiled items that you want to finish washing quickly. For best performance, recommended load is 4 lb (2.0 kg) or lower. |
| Delicates | <ul style="list-style-type: none"> For sheer fabrics, bras, lingerie (silk), and other handwash-only fabrics. |
| Steam Whites | <ul style="list-style-type: none"> For white items. You can wash with or without bleach. |
| Steam Sanitize | <ul style="list-style-type: none"> For colorfast fabrics and heavily soiled laundry, this cycle heats the supplied water over 60 °C to clean deeply. If you stop running the cycle while the washer is heating the water, the door remains locked for your safety. |
| Steam Normal | <ul style="list-style-type: none"> For washing everyday garments with steam. |
| Towels | <ul style="list-style-type: none"> For bath towels, washcloths, and mats. |
| Bedding | <ul style="list-style-type: none"> For bulky items such as comforters, blankets, and sheets. For best results, wash only 1 type of bedding. For bulky items, use liquid detergent and do not roll the items in the drum because they might get stuck in the drum. |
| Outdoor | <ul style="list-style-type: none"> For outdoor clothes, skiwear, and sportswear that are made of functional materials such as spandex, stretch, and micro-fiber. |
| Activewear | <ul style="list-style-type: none"> For exercise wear such as sports jerseys, training pants, shirts/tops and other performance clothing. This cycle provides effective soil removal with controlled drum rotation for special fabric care. |
| Denim | <ul style="list-style-type: none"> For denim and jeans. Wash inside out. Denim and jeans often contain excess dye and may run during the first few washes. Wash light and dark colored items separately. |
| Wool | <ul style="list-style-type: none"> Specific for machine-washable wool for loads less than 4 lb (2.0 kg). The Wool cycle features fine pulsating and soaking to protect the wool fibers from shrinkage/distortion. A neutral detergent is recommended. |



| Cycle | Description |
|----------------|---|
| Colors | <ul style="list-style-type: none"> This cycle washes items in low-temperature water to prevent discoloration. |
| Perm Press | <ul style="list-style-type: none"> For wash-and-wear, synthetic fabrics, and lightly to normally soiled items. |
| Eco Cold | <ul style="list-style-type: none"> For normally and lightly soiled items. This cycle uses only cold water to save energy. Cold water also helps prevent fabric damage. |
| Steam Bulky | <ul style="list-style-type: none"> Bedding cycle with the steam function. |
| Steam Allergen | <ul style="list-style-type: none"> To remove dust, pollen, and other non-living allergen substances from fabric. |
| Power Steam | <ul style="list-style-type: none"> Heavy Duty cycle with the steam function. |
| Power Rinse | <ul style="list-style-type: none"> To wash with powerful rinsing performance. |
| Spin Only | <ul style="list-style-type: none"> To perform the spin process only. |
| Rinse+Spin | <ul style="list-style-type: none"> Features an additional rinse process after fabric softener is applied to the laundry. |
| Self Clean+ | <ul style="list-style-type: none"> Cleans the drum by removing dirt and build-up from the drum. Perform once every 40 washes. Make sure the drum is empty. |

Cycle chart

Use this chart to set the best cycle and options for your laundry.

Upper washer

| Setting | Temp. | Spin | Soil Level |
|---------------------|--------------|---------------|-----------------|
| ● : factory setting | 3 : Warm | - | - |
| ○ : can be selected | 2 : Cold | 2 : Low | 2 : Light |
| | 1 : Tap Cold | 1 : Extra Low | 1 : Extra Light |

| Cycle | Functions | | | | | | |
|------------|-----------|---|---|------|---|------------|---|
| | Temp. | | | Spin | | Soil Level | |
| | 3 | 2 | 1 | 2 | 1 | 2 | 1 |
| Normal | ● | ○ | ○ | ● | | ● | ○ |
| Delicates | ○ | ○ | ● | ● | ○ | ● | ○ |
| Activewear | ● | ○ | ○ | ○ | ● | ○ | ● |
| Rinse+Spin | | | | ● | ○ | | |
| Spin Only | | | | ● | ○ | | |
| Self Clean | ● | | | | ● | ● | |

| Cycle | Options |
|------------|-----------------------|
| | Extra Rinse |
| Normal | <input type="radio"/> |
| Delicates | |
| Activewear | <input type="radio"/> |
| Rinse+Spin | <input type="radio"/> |
| Spin only | |
| Self Clean | |

Lower washer

| Setting | Temp. | Spin | Soil Level |
|---------------------|---------------|----------------|-----------------|
| ● : factory setting | 5 : Extra Hot | 5 : Extra High | 5 : Extra Heavy |
| ○ : can be selected | 4 : Hot | 4 : High | 4 : Heavy |
| | 3 : Warm | 3 : Medium | 3 : Normal |
| | 2 : Cold | 2 : Low | 2 : Light |
| | 1 : Tap Cold | 1 : Extra Low | 1 : Extra Light |



| Cycle | Functions | | | | | | | | | | | | | | |
|----------------|-----------|---|---|---|---|------|---|---|---|---|------------|---|---|---|---|
| | Temp. | | | | | Spin | | | | | Soil Level | | | | |
| | 5 | 4 | 3 | 2 | 1 | 5 | 4 | 3 | 2 | 1 | 5 | 4 | 3 | 2 | 1 |
| Normal | ○ | ○ | ● | ○ | ○ | ○ | ● | ○ | ○ | | ○ | ○ | ● | ○ | ○ |
| Steam Normal | | ● | | | | ○ | ● | ○ | ○ | ○ | ○ | ○ | ● | ○ | ○ |
| Colors | | | | | ● | ○ | ● | ○ | ○ | ○ | ○ | ○ | ● | ○ | ○ |
| Power Rinse | | ○ | ● | ○ | ○ | ○ | ● | ○ | ○ | ○ | ○ | ○ | ● | ○ | ○ |
| Super Speed | | ○ | ● | | | ○ | ● | ○ | ○ | ○ | ○ | ○ | ● | ○ | ○ |
| Heavy Duty | ○ | ● | ○ | ○ | ○ | ● | ○ | ○ | ○ | ○ | ● | ○ | ○ | ○ | ○ |
| Power Steam | | ● | | | | ● | ○ | ○ | ○ | ○ | ● | ○ | ○ | ○ | ○ |
| Bedding | | | ● | ○ | ○ | | | ○ | ● | ○ | ○ | ○ | ● | ○ | ○ |
| Steam Bulky | | | ● | | | | | ○ | ● | ○ | ○ | ○ | ● | ○ | ○ |
| Steam Whites | | ● | | | | ○ | ● | ○ | ○ | ○ | ○ | ○ | ● | ○ | ○ |
| Steam Sanitize | ● | | | | | ○ | ● | ○ | ○ | ○ | ○ | ○ | ● | ○ | ○ |
| Steam Allergen | | ● | | | | ○ | ● | ○ | ○ | ○ | ○ | ○ | ● | ○ | ○ |
| Perm Press | | | ● | ○ | ○ | | ○ | ○ | ● | ○ | ○ | ○ | ● | ○ | ○ |
| Small Load | | ○ | ● | ○ | ○ | ● | ○ | ○ | ○ | ○ | ○ | ○ | ○ | ○ | ● |
| Towels | | ○ | ● | ○ | ○ | ○ | ● | ○ | ○ | ○ | ○ | ○ | ● | ○ | ○ |
| Eco Cold | | | | ○ | ● | ○ | ● | ○ | ○ | ○ | ○ | ○ | ● | ○ | ○ |
| Activewear | | | ● | ○ | ○ | | | | ● | ○ | ○ | ○ | ● | ○ | ○ |
| Delicates | | | ○ | ○ | ● | | | ● | ○ | ○ | ○ | ○ | ● | ○ | ○ |
| Wool | | | ● | ○ | ○ | | | | ● | ○ | | | ● | | |
| Outdoor | | | ● | ○ | ○ | | | ● | ○ | ○ | ○ | ○ | ● | ○ | ○ |
| Denim | | | ● | ○ | ○ | | | ● | ○ | ○ | ○ | ○ | ● | ○ | ○ |
| Rinse+Spin | | | | | | ○ | ● | ○ | ○ | ○ | | | | | |
| Spin Only | | | | | | ○ | ● | ○ | ○ | ○ | | | | | |
| Self Clean+ | ● | | | | | ● | | | | | | | ● | | |



| Cycle | Options | | |
|----------------|-----------------------|----------------------------------|-----------------------|
| | Pre Soak | Super Speed | Extra Rinse |
| Normal | <input type="radio"/> | | <input type="radio"/> |
| Steam Normal | <input type="radio"/> | | <input type="radio"/> |
| Colors | <input type="radio"/> | | <input type="radio"/> |
| Power Rinse | <input type="radio"/> | | <input type="radio"/> |
| Super Speed | | <input checked="" type="radio"/> | <input type="radio"/> |
| Heavy Duty | <input type="radio"/> | <input type="radio"/> | <input type="radio"/> |
| Power Steam | <input type="radio"/> | <input type="radio"/> | <input type="radio"/> |
| Bedding | <input type="radio"/> | <input type="radio"/> | <input type="radio"/> |
| Steam Bulky | <input type="radio"/> | <input type="radio"/> | <input type="radio"/> |
| Steam Whites | <input type="radio"/> | <input type="radio"/> | <input type="radio"/> |
| Steam Sanitize | <input type="radio"/> | | <input type="radio"/> |
| Steam Allergen | <input type="radio"/> | | <input type="radio"/> |
| Perm Press | <input type="radio"/> | | <input type="radio"/> |
| Small Load | | | <input type="radio"/> |
| Towels | <input type="radio"/> | | <input type="radio"/> |
| Eco Cold | <input type="radio"/> | | <input type="radio"/> |
| Activewear | <input type="radio"/> | | <input type="radio"/> |
| Delicates | | | <input type="radio"/> |
| Wool | | | |
| Outdoor | | | <input type="radio"/> |
| Denim | <input type="radio"/> | | <input type="radio"/> |
| Rinse+Spin | | | <input type="radio"/> |
| Spin Only | | | |
| Self Clean+ | | | |

Options

Using Options

1. Tap UPPER or LOWER to select the upper or lower washer.
2. Tap Options.
3. Turn the Navigation dial to select the desired additional function.
4. Tap OK to change the selected function's settings or start the function.

NOTE

- To return to the main screen, tap Options again or turn the Navigation dial to select Back, and then tap OK.
- If the selected function is not supported, the "Currently not supported." message is displayed, and the OK button is not activated.

- When you select an additional function, a brief help message appears for the first ten times of use.
- Only the Extra Rinse, My Cycles, and Child Lock functions are available for the upper washer.

Super Speed

Use this function if you need to shorten the washing time.

1. Tap Options.
2. Turn the Navigation dial to select Super Speed, and then tap OK.
3. Tap OK to select On or Off.

Only available with Super speed, Heavy Duty, Power Steam, Bedding, Steam Bulky, and Steam Whites cycles.

The shortened time may differ depending on the load/options.

Extra Rinse

Adds an additional rinse at the end of the cycle to remove laundry additives more thoroughly.

1. Tap UPPER or LOWER to select the upper or lower washer.
2. Tap Options.
3. Turn the Navigation dial to select Extra Rinse, and then tap OK.
4. Tap OK to select On or Off.

Pre Soak

This adds 30 minutes of soaking time at the start of the wash cycle for better stain removal.

1. Select a cycle and change the cycle settings as necessary.
2. Tap Options.
3. Turn the Navigation dial to select Pre Soak, and then tap OK.
4. Tap OK to select On or Off.

My Cycles

Add or remove cycles to create a personal cycle list.

1. Tap UPPER or LOWER to select the upper or lower washer.
2. Tap Options.
3. Turn the Navigation dial to select My Cycles, and then tap OK.
You can only edit a cycle to create a personal cycle when the washer is not operating.
4. Turn the Navigation dial to select a desired cycle.
5. Tap OK to add or remove the selected cycle.
Addition and removal of the cycle is saved automatically.
6. Once you finish creating My Cycles, tap Options to return to the cycles screen.

NOTE

- The Normal, Self Clean (upper), and Self Clean+ (lower) cycles cannot be removed from the cycles list.
- You can also edit My Cycles in the SmartThings app.

Drum Light

You can turn the drum light on or off.

1. Tap Options.
2. Turn the Navigation dial to select Drum Light, and then tap OK.
3. Tap OK to select On or Off.

Delay End

You can set the washer to finish your wash automatically at a later time, choosing a delay of between 1 to 24 hours (in 1 hour increments). The hour displayed indicates the time the wash will finish.

1. Select a cycle and change the cycle settings as necessary.
2. Tap Options.
3. Turn the Navigation dial to select Delay End, and then tap OK.
4. Turn the Navigation dial to select the desired time, and then tap OK.
5. Tap and hold .

Status shows in the display and the washer tumbles the drum to sense the weight of the load (if load sensing is preset for the selected cycle). When load sensing is complete, the display shows the remaining time until the end of the wash cycle.

To cancel Delay End, tap  to restart the washer.

Child Lock

To prevent children or infants from accidentally starting or setting the washer, Child Lock locks all buttons except for  and Options.

1. Tap Options.
2. Turn the Navigation dial to select Child Lock, and then tap OK.
3. Tap OK to select On or Off.

NOTE

- Child Lock applies to both the upper and lower washers.
- When Child Lock is on, all buttons are disabled except for  and Options. The washer door also locks.

- Tapping a button while Child Lock is on triggers an alarm with the "Child Lock On" message.
- You cannot open the door after a wash cycle when the Child Lock is on. Turn the function off before opening the door to take out the laundry.

System Functions

Using System Functions

1. Tap and hold Options for 3 seconds.
2. Turn the Navigation dial and select the desired system function, and then tap OK.
3. Tap OK to change the selected function's settings or start the function.

NOTE: To return to the main screen, tap Options again or turn the Navigation dial to select Back, and then tap OK.

AI Pattern

This function saves frequently used cycles and settings. When you turn the function on, the washer remembers the cycles you use most and their settings (Temp., Rinse, Spin) and displays them in frequency order.

1. Tap and hold Options for 3 seconds.
2. Turn the Navigation dial to select AI Pattern, and then tap OK.
3. Tap OK to select On or Off.
The default setting is On. Set it to Off if you do not want to use this function.
When you turn off the function, all the saved data resets.

Alarm

You can turn the sound on or off from the washer. When this function is set to Off, the melody of cycle completion and the power-off beep does not sound. However, the other sounds stay active.

1. Tap and hold Options for 3 seconds.
2. Turn the Navigation dial to select Alarm, and then tap OK.
3. Tap OK to select On or Off.
The default setting is On.

NOTE: The setting remains unchanged even if you restart the washer.

Calibration

You can run calibration again for accurate weight detection.

1. Tap and hold Options for 3 seconds.
2. Turn the Navigation dial to select Calibration, and then tap OK.
Calibration does not start if the door is not closed properly.
The drum rotates clockwise and anticlockwise for about 4 minutes.

3. When calibration is complete, the "Calibration complete" message appears on the display and the washer turns off automatically.

Wi-Fi

You can turn the washer's Wi-Fi on or off.

1. Tap and hold Options for 3 seconds.
2. Turn the Navigation dial to select Wi-Fi, and then tap OK.
3. Tap OK to select On or Off.

The washer's Wi-Fi is off as a factory default setting. However, the washer's Wi-Fi turns on automatically when you turn on the washer for the first time. Then, the final Wi-Fi setting maintains regardless of the washer power status.

Once you turn on the washer's Wi-Fi and connect to a network, the washer remains connected to the network even when you turn off the power.

The Wi-Fi  indicates that the washer is connected to the router through the Wi-Fi connection.

Language

You can change the system language.

1. Tap and hold Options for 3 seconds.
2. Turn the Navigation dial to select Language, and then tap OK.
3. Turn the Navigation dial to select the desired language, and then tap OK.

Self diagnosis

You can use this function to check if there are any abnormal signs on your washer.

1. Tap and hold Options for 3 seconds.
2. Turn the Navigation dial to select Self diagnosis, and then tap OK.
Self diagnosis starts immediately and the result appears on the screen once the diagnosis is complete.

Factory Reset

You can reset the washer.

1. Tap and hold Options for 3 seconds.
2. Turn the Navigation dial to select Factory Reset, and then tap OK.
Your washer resets to the factory setting.

Special features

Smart control

You can connect to the SmartThings app and control your washer remotely.

Connecting your washer

1. Download and open the SmartThings app on your smartphone or tablet (Android & iOS).
2. Tap  to turn on the washer.
3. Tap and hold Smart Control.
 - a. The washer enters AP mode and connects to your smartphone or tablet.
 - b. Tap Smart Control to authenticate your washer.
 - c. Once the authentication process is complete, your washer is successfully connected to the app.You can use various features available in the SmartThings app.

NOTE

- If your washer fails to connect with the SmartThings app, try again.
- Check your router if you experience any Internet connection problem after connecting your washer with the SmartThings app.
- If the Wi-Fi is off, tap and hold Options for 3 seconds to enter the System functions menu, and select Wi-Fi to turn it on.
- Turning the washer's Wi-Fi on allows you connect to the washer via SmartThings app on your smartphone or tablet, regardless of the power status of the washer. However, the washer appears offline on the SmartThings app if the washer's Wi-Fi is off.
- Close the door before starting the Smart Control function.
- If you use your washer for a while without connecting it to the SmartThings app, a pop-up message about Smart Control will show for 3 seconds on 20th, 40th, and 60th use.
- If the washer's Wi-Fi is not connected to an AP (access point), the Wi-Fi will turn off when you turn off the power.

Stay Connect

Set up the Stay Connect function in your SmartThings app to keep Smart Control turned on at the end of a cycle. Your washer stays connected to the app so you can send additional instructions, whether you are at home or away.

1. If you turn on the Stay Connect function on the SmartThings app, the washer will stay in standby power saving mode after completing a cycle.

The Stay Connect function will remain active for up to 24 hours if the door remains closed.
2. When the Stay Connect function is active, the Smart Control, Door Lock, and Wi-Fi icons are illuminated on your washer display.
3. You can conveniently control your washer, adding rinse, spin cycles using the SmartThings app.

NOTE

- The washer switches to standby power saving mode when operation is paused even if the machine is not connected to the SmartThings app.
- In some circumstances, only the Door Lock icon may be illuminated.

SmartThings

Wi-Fi connection

On your smartphone or tablet, go to Settings and turn on the wireless connection and select an AP (Access Point).

- This appliance supports the Wi-Fi 2.4 GHz protocols.

Download

On an app market (Google Play Store, Apple App Store, Samsung Galaxy Apps), find the SmartThings app by searching for "SmartThings". Download and install the app on your device.

NOTE: The app is subject to change without notice for improved performance.

Log in

You must first log into SmartThings with your Samsung account. To create a new Samsung account, follow the instructions on the app. You don't need a separate app to create your account.

NOTE: If you have a Samsung account, use the account to log in. A registered Samsung smartphone or tablet user automatically logs in.

To register your appliance to SmartThings

1. Make sure your smartphone or tablet is connected to a wireless network. If not, go to Settings and turn on the wireless connection and select an AP (Access Point).
2. Open SmartThings on your smartphone or tablet.
3. If you see the message, "A new device is found.", select Add.
4. If no message appears, select + and select your appliance in a list of devices available. If your appliance is not listed, select Device Type > Specific Device Model, and then add your appliance manually.
5. Register your appliance to the SmartThings app as follows.
 - a. Add your appliance to SmartThings. Make sure your appliance is connected to SmartThings.
 - b. When registration is complete, your appliance appears on your smartphone or tablet.

If you're moving out, we recommend you completely wipe the appliance and do a network reset on it before you leave it behind.

If you're moving in, the easiest way to take control and remove the previous user's access is to add it to SmartThings yourself. But if you don't plan on using SmartThings, a network reset should be

performed to protect your privacy. In rental properties, there's a regular change of ownership. To ensure resident privacy, Wi-Fi and/or other connectivity settings should be reset at each change of resident. Please refer to factory reset instructions in this manual.

Maintenance

Keep the washer clean to prevent its performance from deteriorating and to preserve its life cycle.

WARNING: Certain internal parts are intentionally not grounded and may present a risk of electric shock only during servicing. Service personnel – Do not contact the following parts while the appliance is energized: Control board, heat sink, motor, inlet valve and pump.

General considerations

Cleaning

Surface of the washer

Use a soft cloth with a nonabrasive household detergent. Do not spray water onto the washer

Exterior

1. Turn off the water taps after finishing the day's washing. This will shut off the water supply to your washer and prevent the unlikely possibility of damage from escaping water. Leave the door open to allow the inside of your washer to dry out.
2. Use a soft cloth to wipe up all detergent, bleach, or other spills as they occur. Clean the following as recommended below:

Control panels – Clean with a soft, damp cloth. Do not use abrasive powders or cleaning pads. Do not spray cleaners directly on the panels.

Cabinet – Clean with soap and water.

Interior

Clean the interior of your washer periodically to remove any dirt, soil, odor, mold, mildew, or bacterial residue that may remain in your washer as a result of washing clothes.

CAUTION: Failure to follow these instructions may result in unpleasant conditions, including odors and/or permanent stains on your washer or laundry.

NOTE: Hard water deposits may be removed, if needed. Use a cleaner labeled "Washer safe".

Mesh filter

Clean the mesh filter of the water hose once or twice a year.

1. Turn off the washer, and then unplug the power cord.
2. Close the taps.

3. Loosen and disconnect the water hose from the back of the washer. Cover the end of each hose with a cloth to prevent water from gushing out.

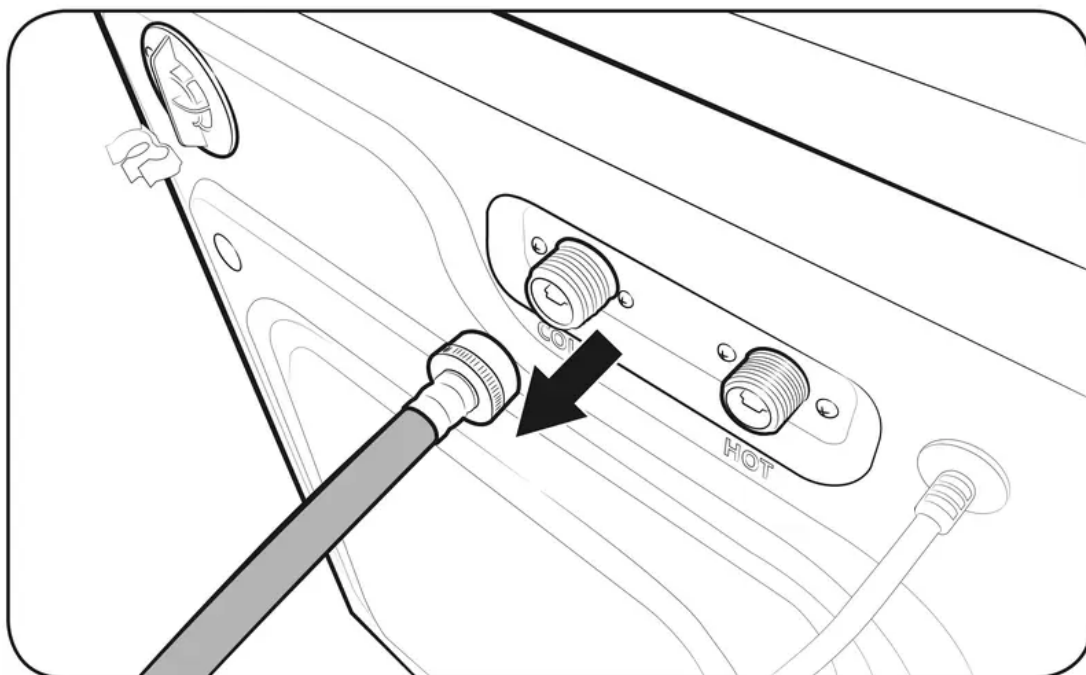

4. Use pliers to pull out the mesh filter from the inlet valve.
5. Submerge the mesh filter deeply in water so that the threaded connector is also submerged.
6. Dry the mesh filter completely in a shaded area.
7. Reinsert the mesh filter into the inlet valve, and reconnect the water hose to the inlet valve.
8. Open the tap.

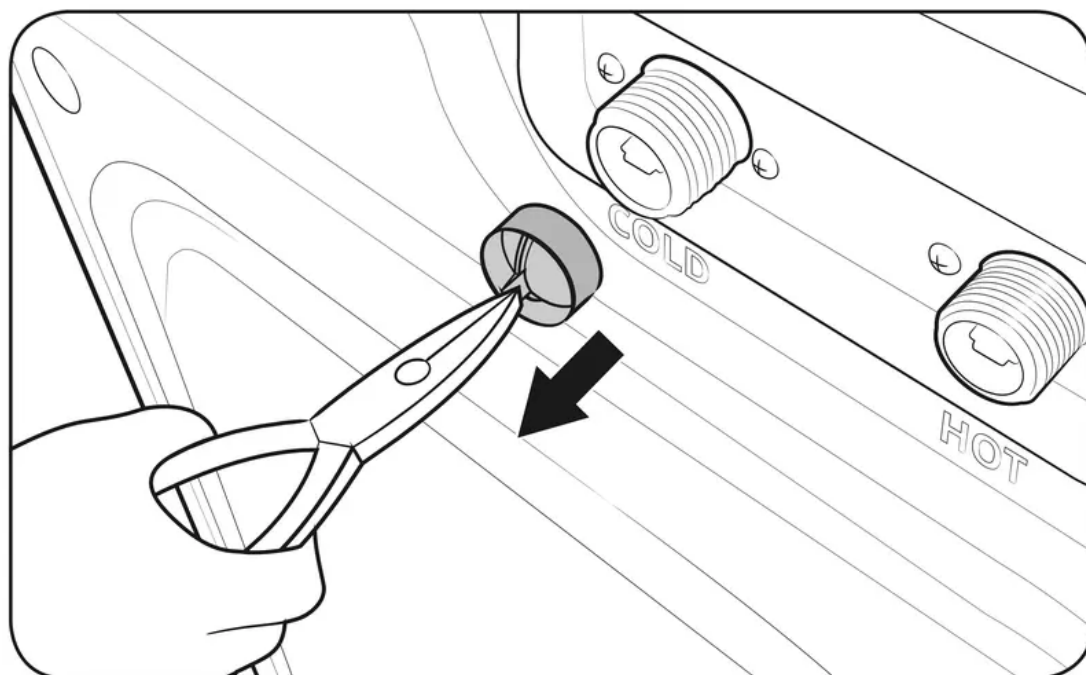

NOTE: If the mesh filter is clogged, the "4C" information code appears on the washer's display.

Recovery from freezing

The washer may freeze when the temperature in its location drops below 32 °F (0 °C).

1. Turn off the washer, and then unplug the power cord.
2. Pour warm water over the tap to loosen the water hose.
3. Disconnect the water hose, and soak it in warm water.
4. Pour warm water into the drum (tub) and leave it for about 10 minutes.
5. Reconnect the water hose to the tap.

NOTE: If the washer still doesn't operate normally, repeat the steps above until it operates normally.

If the washer will not be used for an extended period of time



Avoid leaving the washer unused for an extended time. If you intend to leave the washer unused for a long period of time, follow the directions below:

1. Press Power, and then select Rinse+Spin.
2. Empty both the drum and the tub, close the door, and then press Start/Pause.
3. When the cycle is complete, close the tap and disconnect the water hoses.
4. Turn off the washer, and then unplug the power cord.
5. Open the doors to let air circulate through the drum and the tub.

Upper washer

Self Clean

Certain usage and environmental conditions may result in some residue build-up or odor in the washer tub. To prevent this build-up of residue or odor causing bacteria and keep your washer tub fresh and clean, perform the Self Clean cycle at least once a month or every 20 cycles. Perform the recommended procedure below when using the Self Clean cycle.

1. Remove all items from the washer tub and ensure the tub is empty. Laundry left in the tub during the Self Clean cycle may be damaged.
2. Tap  to turn the power on.
3. Tap UPPER.
4. Turn the Navigation dial to select Self Clean.
5. Tap and hold upper .

NOTE

- The water temperature for Self Clean is defaulted to 3 (Warm). This temperature cannot be changed.

- In the case where residue is present in the washer tub, add 1/3 cup (2.7 fl. oz., 80 ml) of liquid chlorine bleach directly to the empty tub before you start the Self Clean cycle. Do not use or mix any other detergent or chemicals during the Self Clean cycle.
- If necessary, run a Rinse+Spin Cycle after the Self Clean cycle has completed to help remove any remaining residue.

CAUTION

- Check the washer tub before using the Self Clean cycle. Remove any remaining water in the tub by running a Spin Only cycle prior to starting the Self Clean cycle.
- If there is chlorine bleach left in the washer tub for an extended period of time, rust can occur.

Self Clean reminder ()

- After 20 washing cycles, the Self Clean LED reminder icon and the Self Clean cycle LED will blink on the control panel for an hour and then turn off automatically.
- The reminder will appear on the control panel for 5 additional consecutive cycles before turning off. The next reminder will not appear until another 20 cycles have been completed.

Fabric softener/bleach compartment

Both the fabric softener compartment and the bleach compartment on the upper washer are not removable by design to facilitate visual feedback to users. To clean the softener compartment, follow these instructions. Cleaning the bleach compartment is basically the same.

1. Open the top door, and then remove the softener cap.

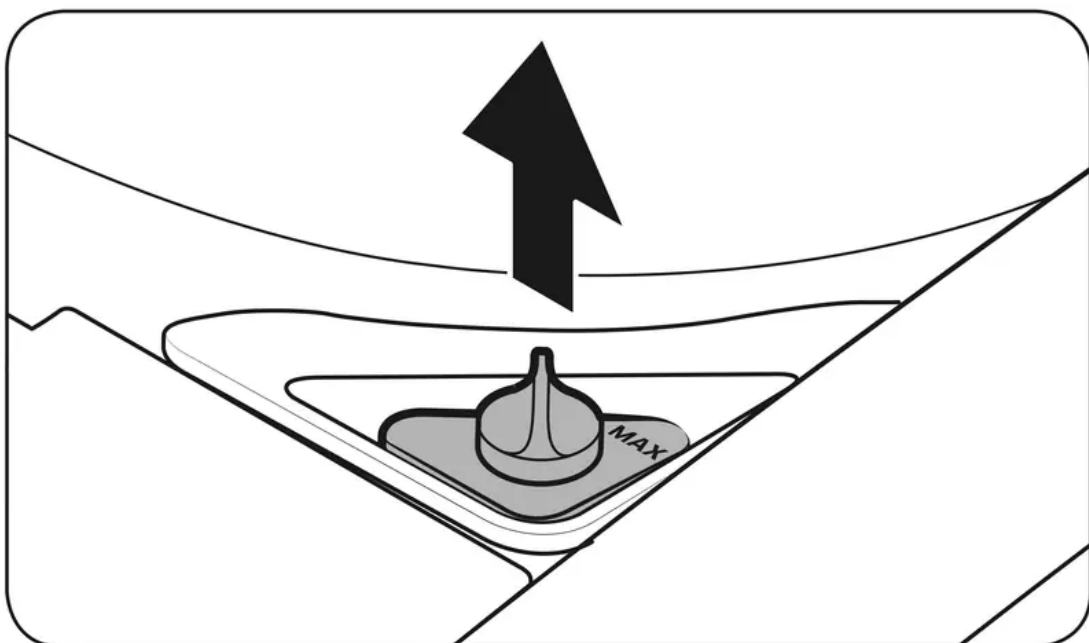

2. Use a soft brush (for example, a toothbrush) to clean inside the compartment and remove impurities.

3. Run the Rinse+Spin cycle to rinse the compartment.

After supplying water and draining 5 times, the 18-minute cycle completes with the final spin process.

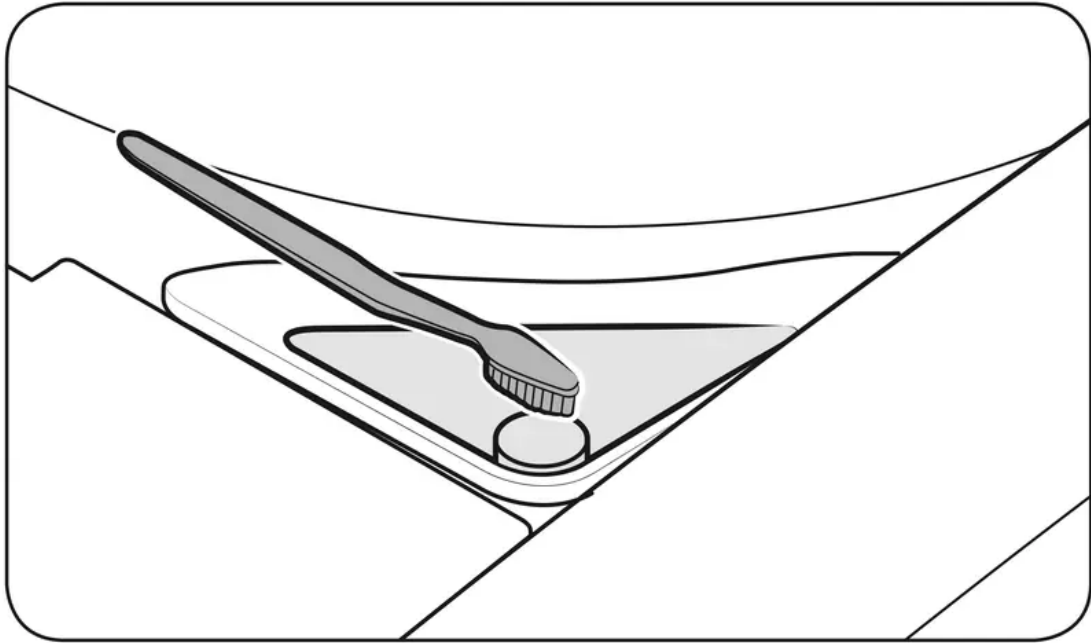

Lint filter

We recommend cleaning the lint filter every 10 washes.

1. Remove the lint filter from the filter case on the tub of the upper washer.

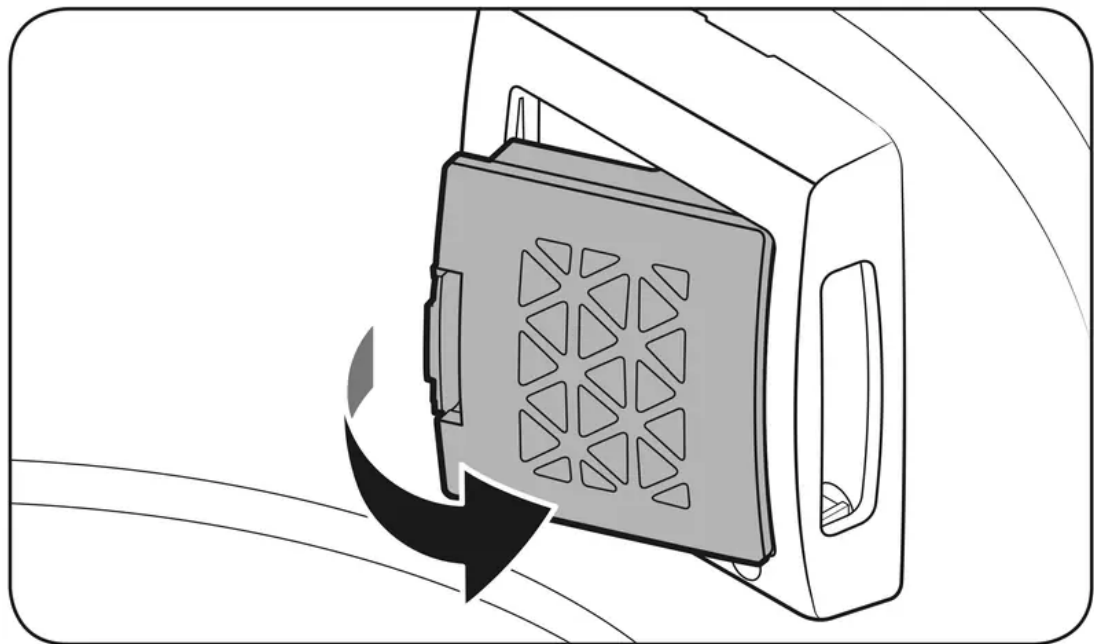
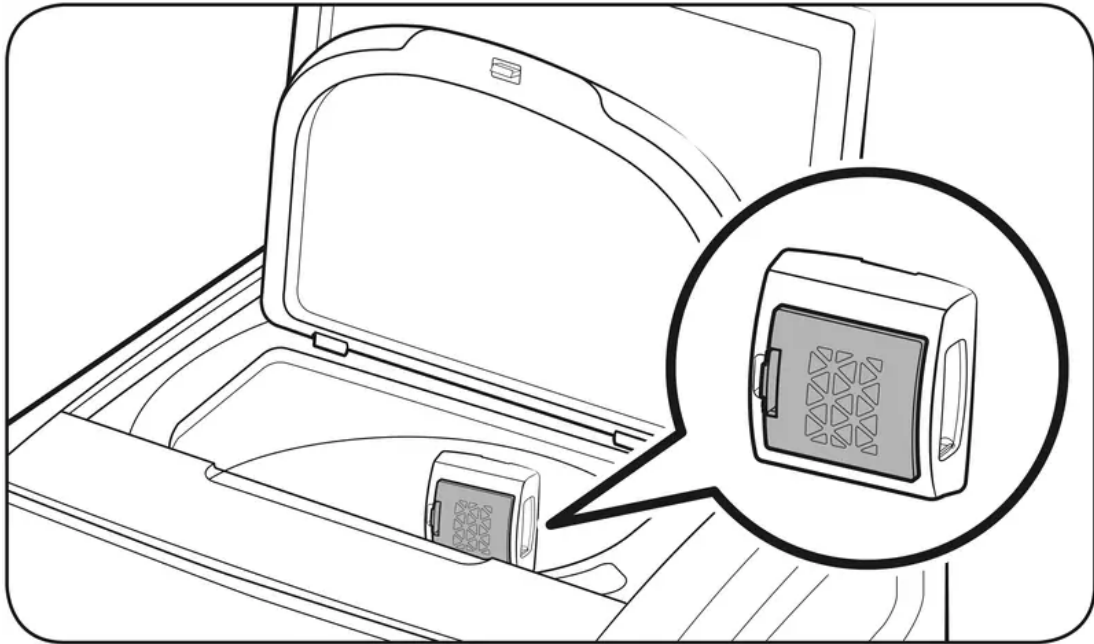

2. Open the filter, and clean it with running water and a brush.

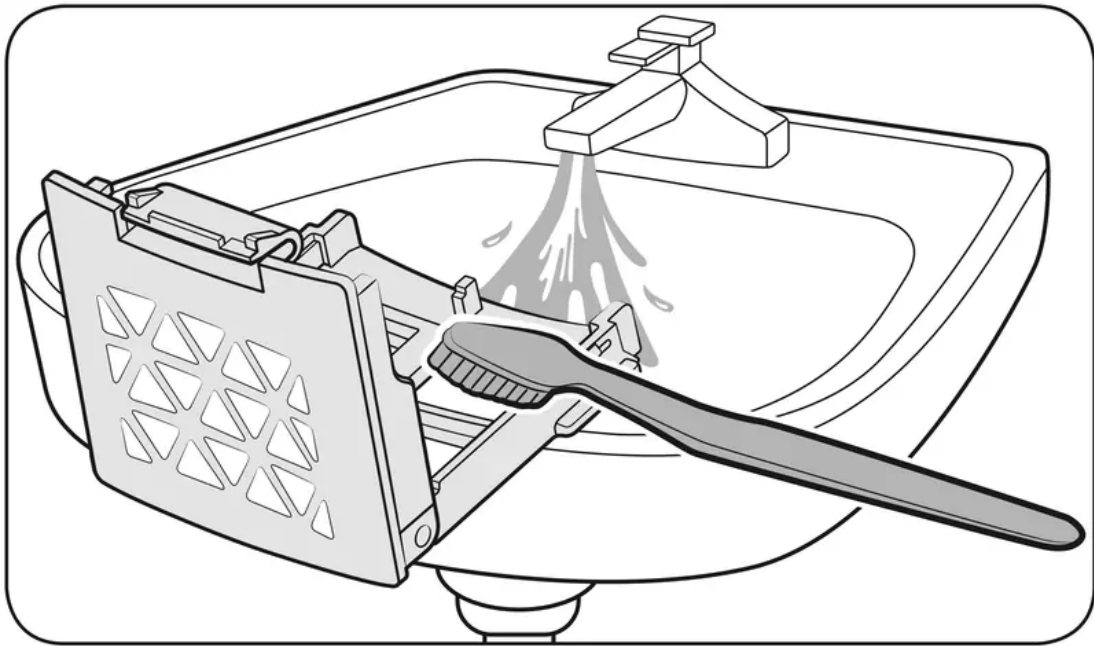

3. When cleaning is complete, close the filter and reinsert it in its original position. You will hear a clicking sound when the filter is inserted correctly.



Lower washer

Self Clean+

Certain usage and environmental conditions may result in some residue build-up or odor in the washer drum. To prevent this build-up of residue or odor causing bacteria and keep your washer drum fresh and clean, perform the Self Clean+ cycle at least once a month or every 40 cycles. Perform the recommended procedure below when using the Self Clean+ cycle.

1. Remove all items from the washer drum and ensure the drum is empty. Laundry left in the drum during the Self Clean+ cycle may be damaged.
2. Tap  to turn the power on.
3. Tap LOWER.
4. Turn the Navigation dial to select Self Clean+.
5. Tap and hold lower .

NOTE

- The water temperature for Self Clean+ is defaulted to Hot. This temperature cannot be changed.
- In the case where residue is present in the washer drum, add liquid chlorine bleach to the MAX level line in the main-wash compartment before starting the Self Clean+ cycle. Do not add the liquid chlorine bleach to the bleach compartment (This is only the case for Self Clean+ cycle). Do not exceed the max line. Do not use or mix any other

detergent or chemicals during the Self Clean+ cycle. If necessary, run a Rinse+Spin Cycle after the Self Clean+ cycle has completed to help remove any remaining residue.

CAUTION: If there is chlorine bleach left in the washer drum for an extended period of time, rust can occur.

Self Clean+ reminder ()

- After 40 washing cycles, the Self Clean+ LED reminder icon and the Self Clean+ cycle LED will blink on the control panel for an hour and then turn off automatically.
- The reminder will appear on the control panel for 5 additional consecutive cycles before turning off. The next reminder will not appear until another 40 cycles have been completed.

Main wash compartment

The main wash compartment needs to be cleaned periodically to remove buildup of laundry additives.

1. Open the top-front cover. Grasp the main wash compartment, and then pull up to remove.

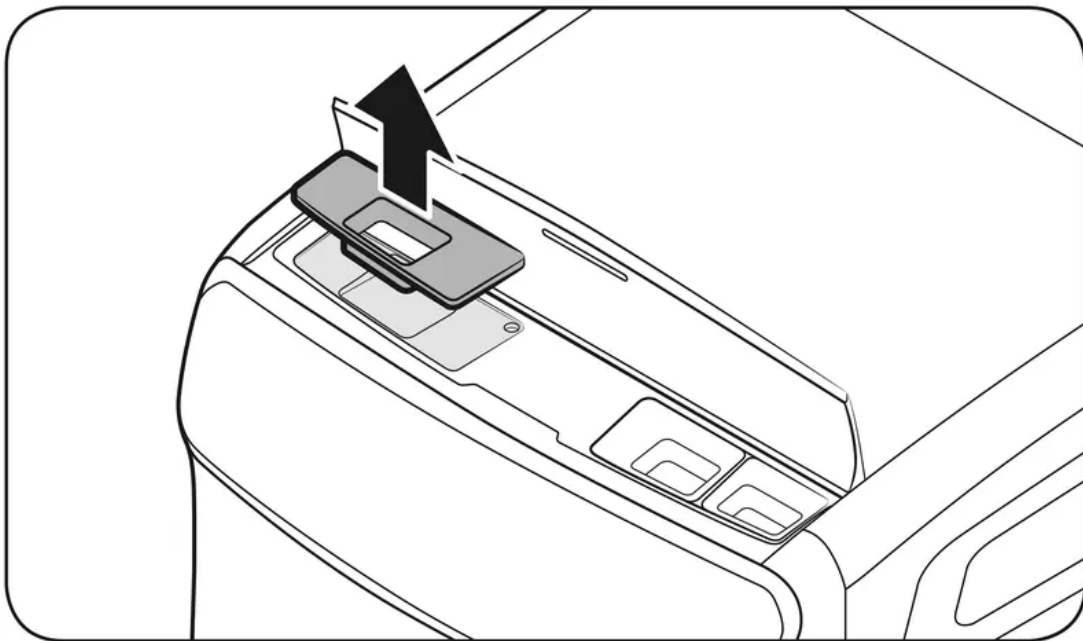

2. Remove all residue and traces of accumulated laundry agents from the compartment.
Rinse it with warm water.

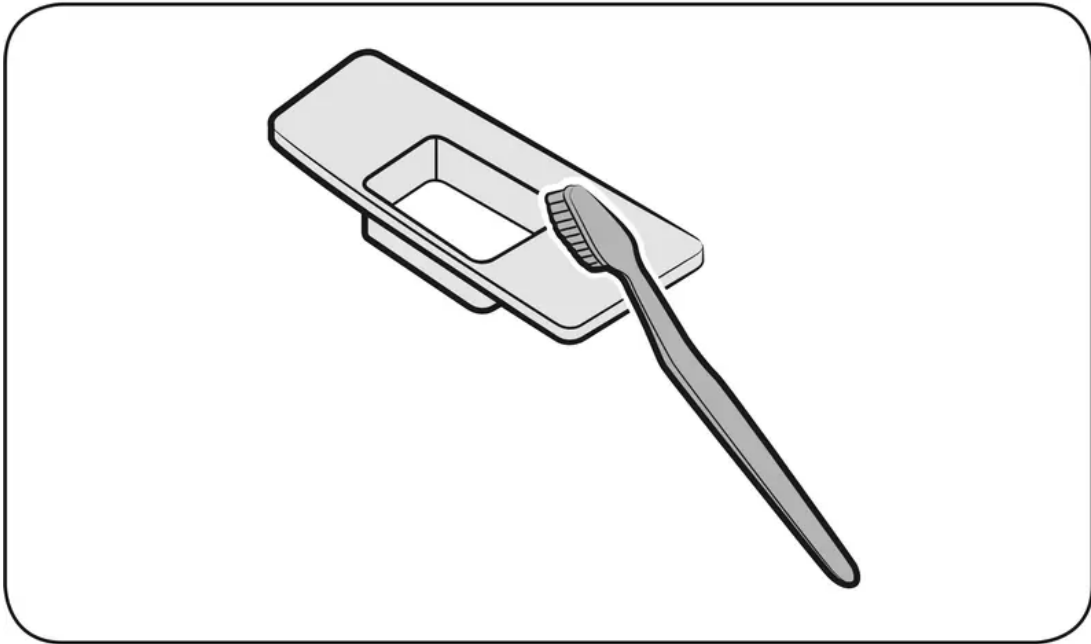

3. To clean the recess of the compartment, use a small, non-metal brush. Remove all residue from all sides of the recess.
4. Reinsert the compartment into place.

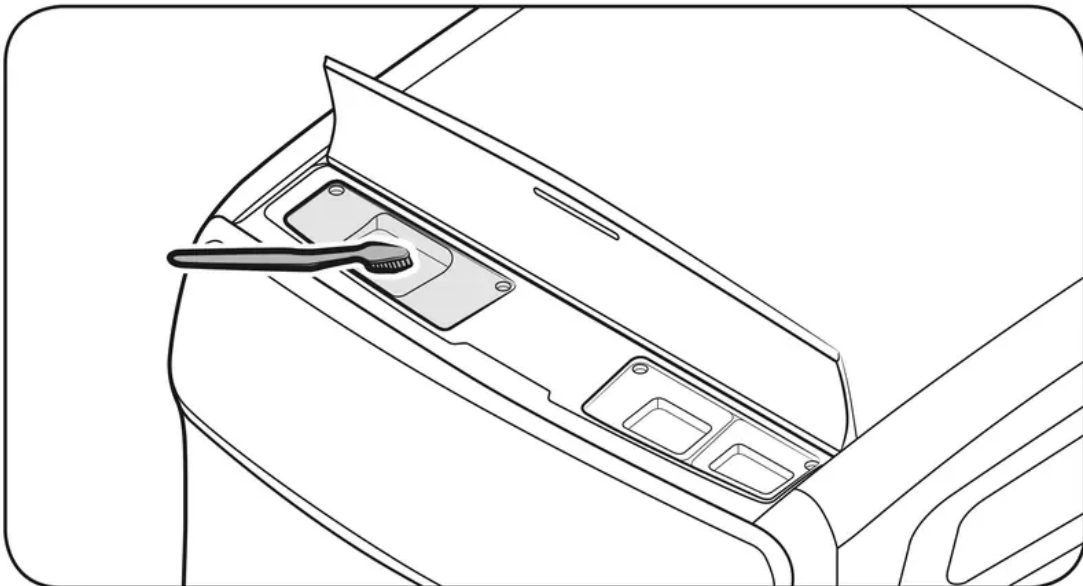

Fabric softener/bleach compartment

Both the fabric softener compartment and the bleach compartment on the lower washer are not removable by design to facilitate visual feedback to users. To clean the softener compartment, follow these instructions. Cleaning the bleach compartment is basically the same.

1. Open the top-front cover, and then remove the softener cap.

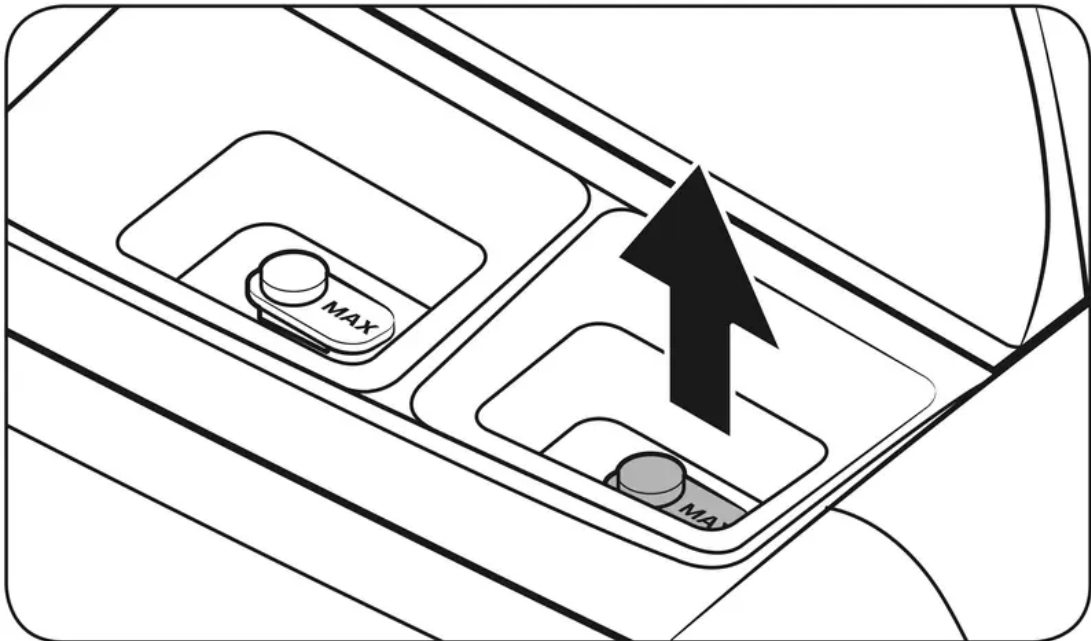

2. Use a soft brush (for example, a toothbrush) to clean inside the compartment and remove impurities.
3. Run the Rinse+Spin cycle to rinse the compartment.
After supplying water and draining 5 times, the 19-minute cycle completes with the final spin process.

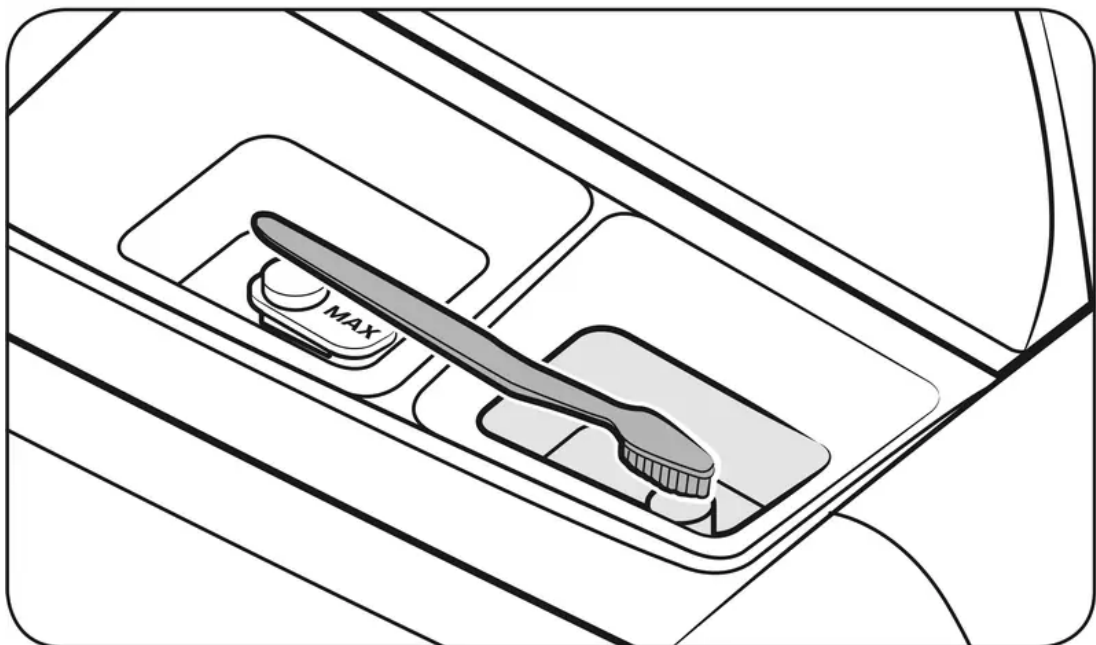

Door diaphragm

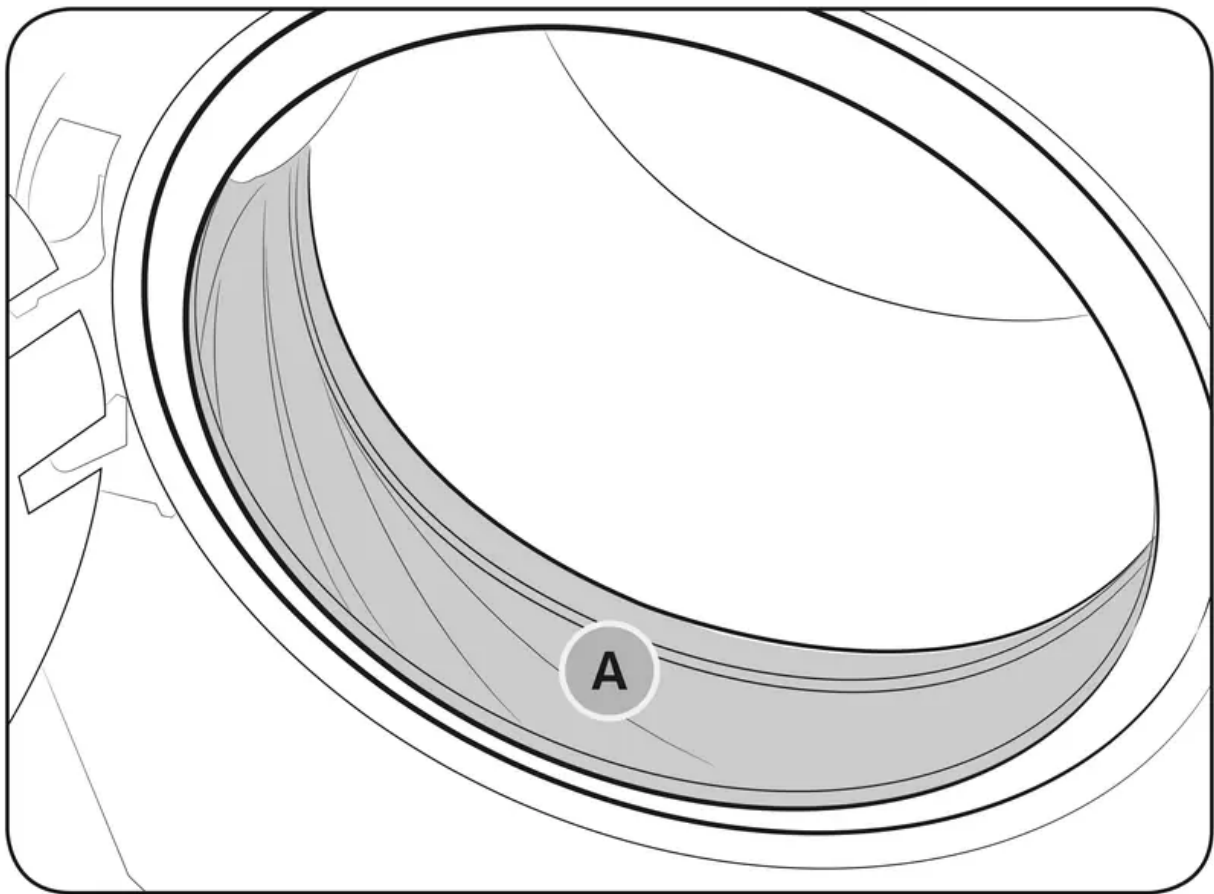

1. Open the door and empty the drum.
2. Turn out the diaphragm (sealing or gasket of the drum (A)), and check if it is stained. If so, follow the steps below.
3. Combine $\frac{3}{4}$ cups of liquid chlorine bleach and 1 gallon of warm tap water.
4. Wearing rubber gloves, use a soft, clean cloth dipped in the water and chlorine solution to clean the diaphragm.
5. Let stand for 5 minutes, and then wipe up and dry well.

CAUTION: Use bleach carefully and be sure to follow the bleach manufacturer's use and care instructions.

NOTE: Dust may accumulate on the door diaphragm during washing and drying (especially for drying). Therefore, clean the diaphragm after each washing and drying cycles.

Emergency drain

In case of a power failure, drain the water inside the drum before taking out the laundry.

1. Power off the washer, and then unplug it from the electrical outlet.

2. Gently press the top area of the filter cover to open.

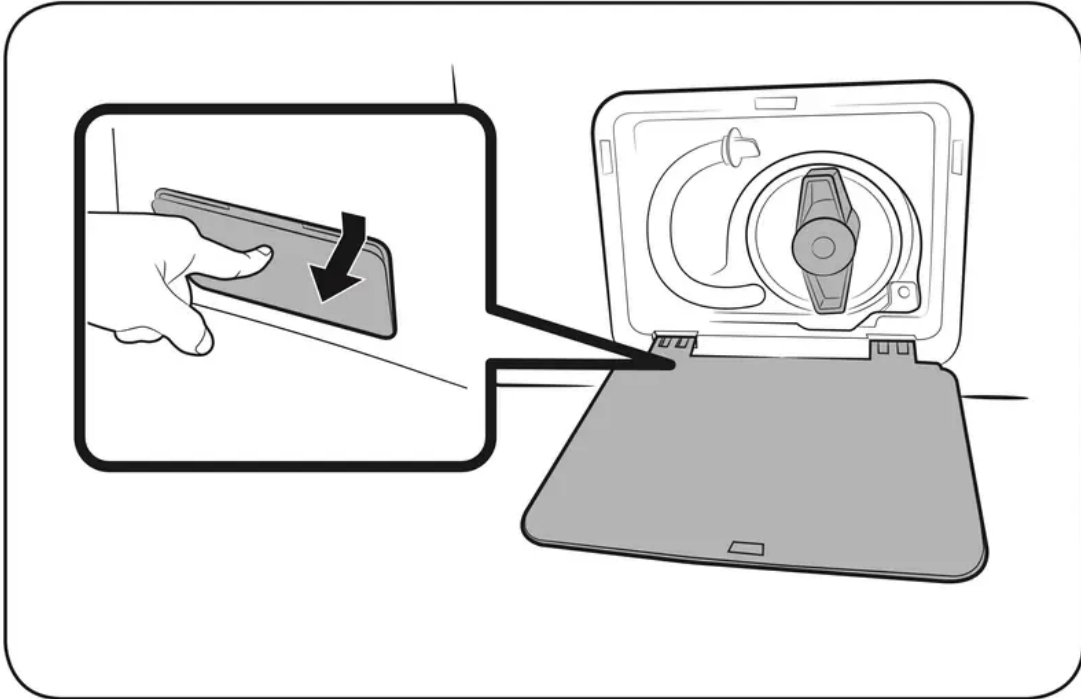

3. Put an empty, spacious container in front of the cover, and stretch the emergency drain tube to the container while holding the tube cap (A).

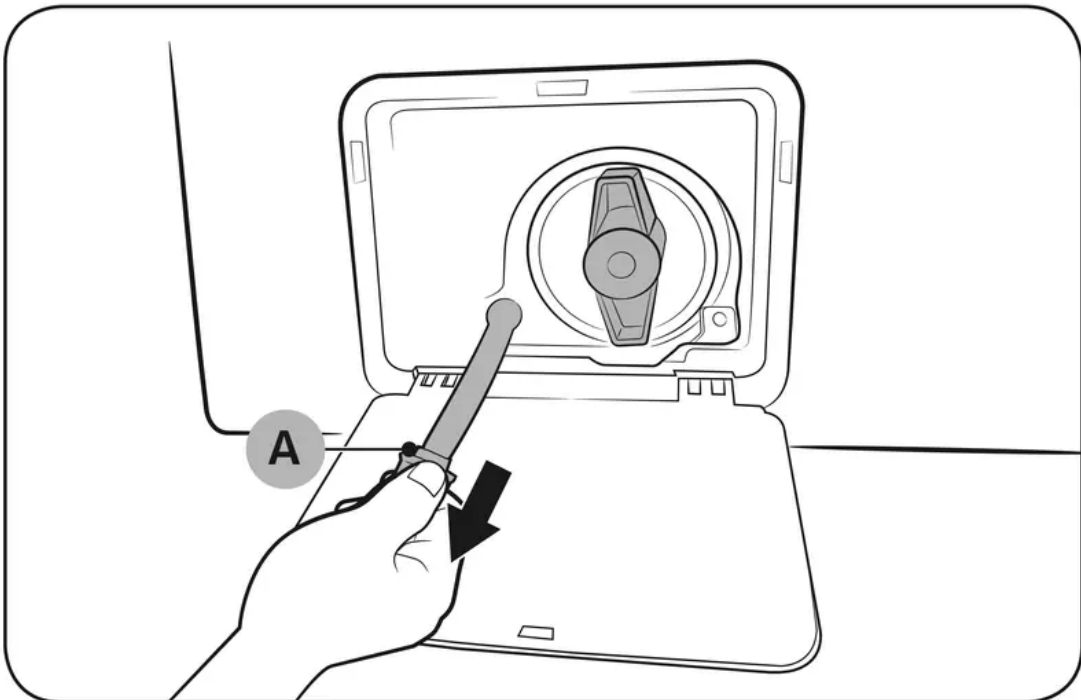

4. Open the tube cap and let water in the Emergency drain tube (B) flow into the container.

5. When done, close the tube cap, and reinsert the tube.

Then, close the filter cover.

NOTE: Use a spacious container because the water in the drum may be more than

expected.

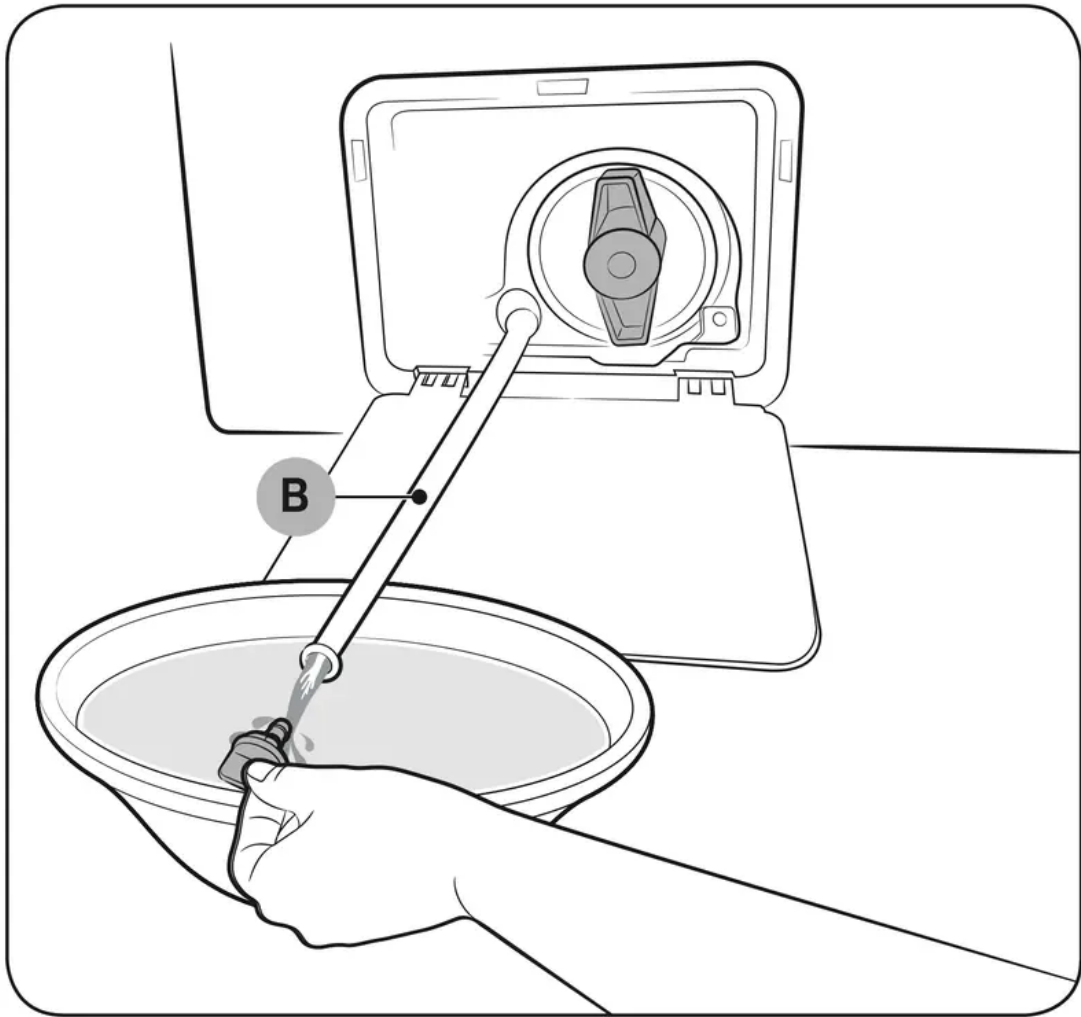

Pump filter

It is advisable to clean the pump filter 5 or 6 times a year to prevent it from clogging. A clogged pump filter may reduce the bubble effect.

1. Turn off the washer, and then unplug the power cord.
2. Drain the remaining water inside the drum. See the Emergency drain section on page 68.
3. Gently press the top area of the filter cover to open.

4. Turn the pump filter knob (A) to the left, and drain off the remaining water.

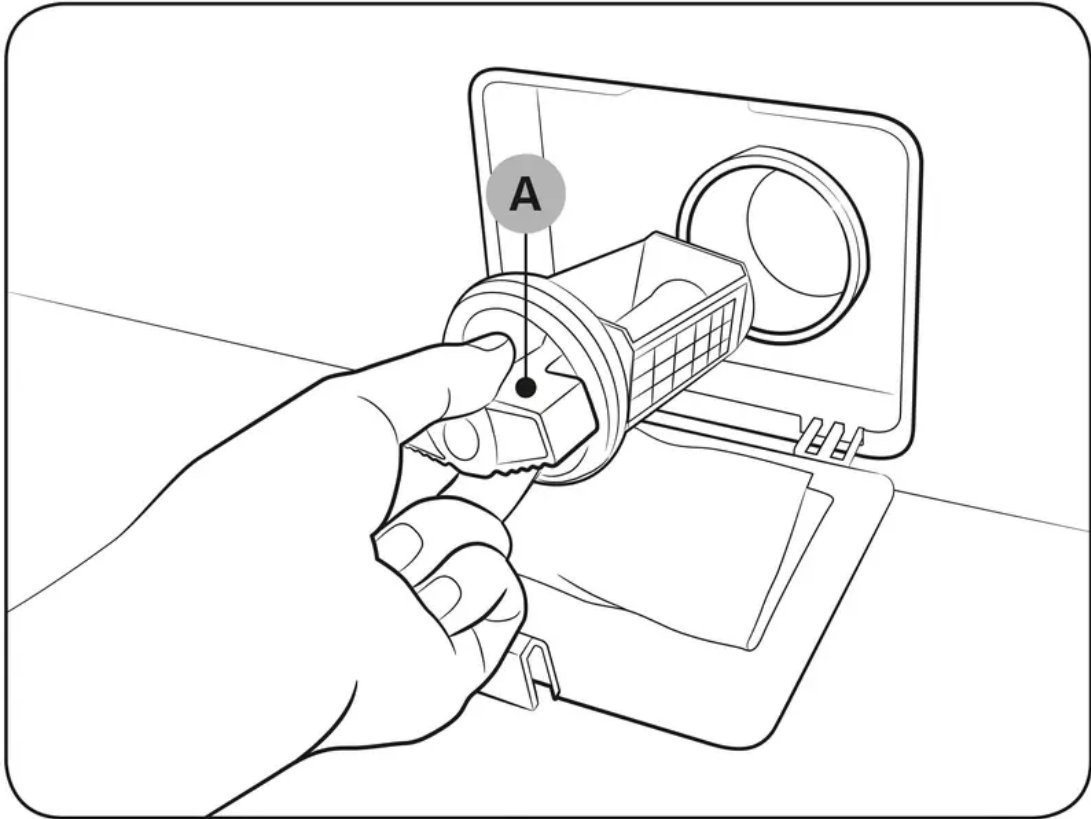

5. Clean the pump filter using a soft brush. Make sure the drain pump propeller inside the filter is not clogged.

6. Reinsert the pump filter, and then turn the filter knob to the right.



7. Close the filter cover.

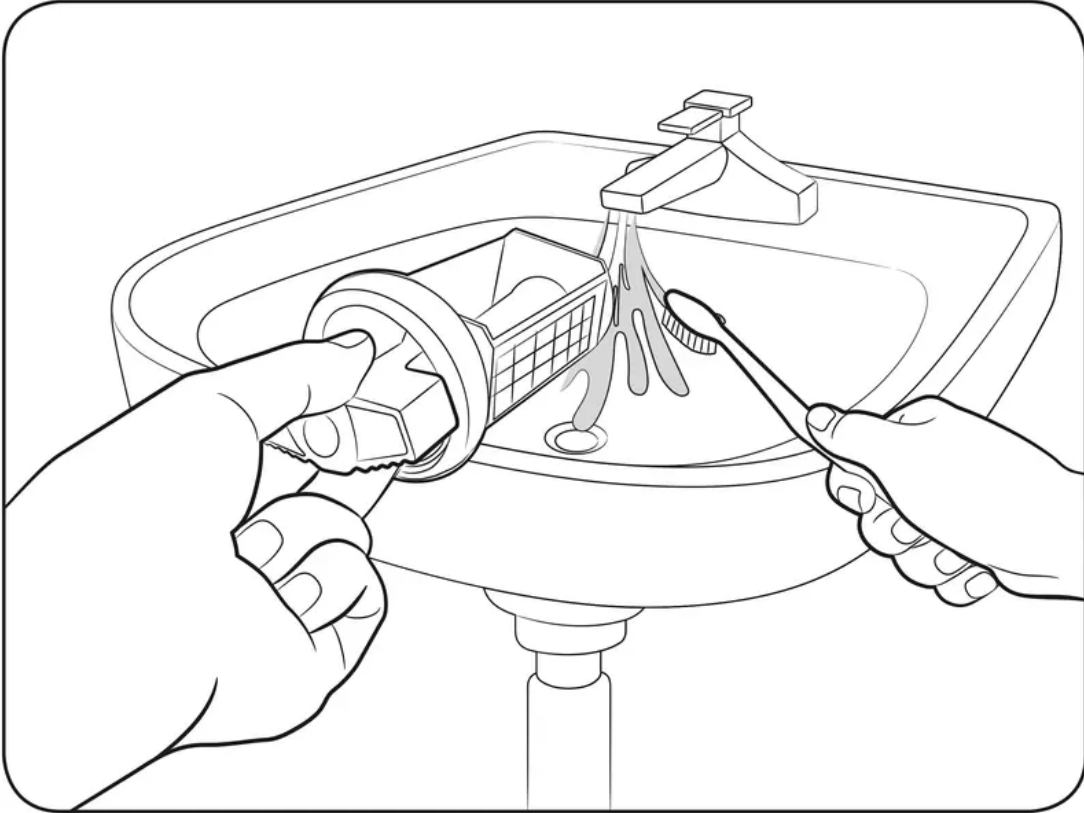

NOTE

- Some pump filters feature a safety knob that is designed to prevent children from accidentally opening the filter compartment. To open the safety knob of the pump filter, push in and turn it counterclockwise. The spring mechanism of the safety knob helps open the filter.
- To close the safety knob of the pump filter, turn it clockwise. The spring makes a rattling sound, which is normal.



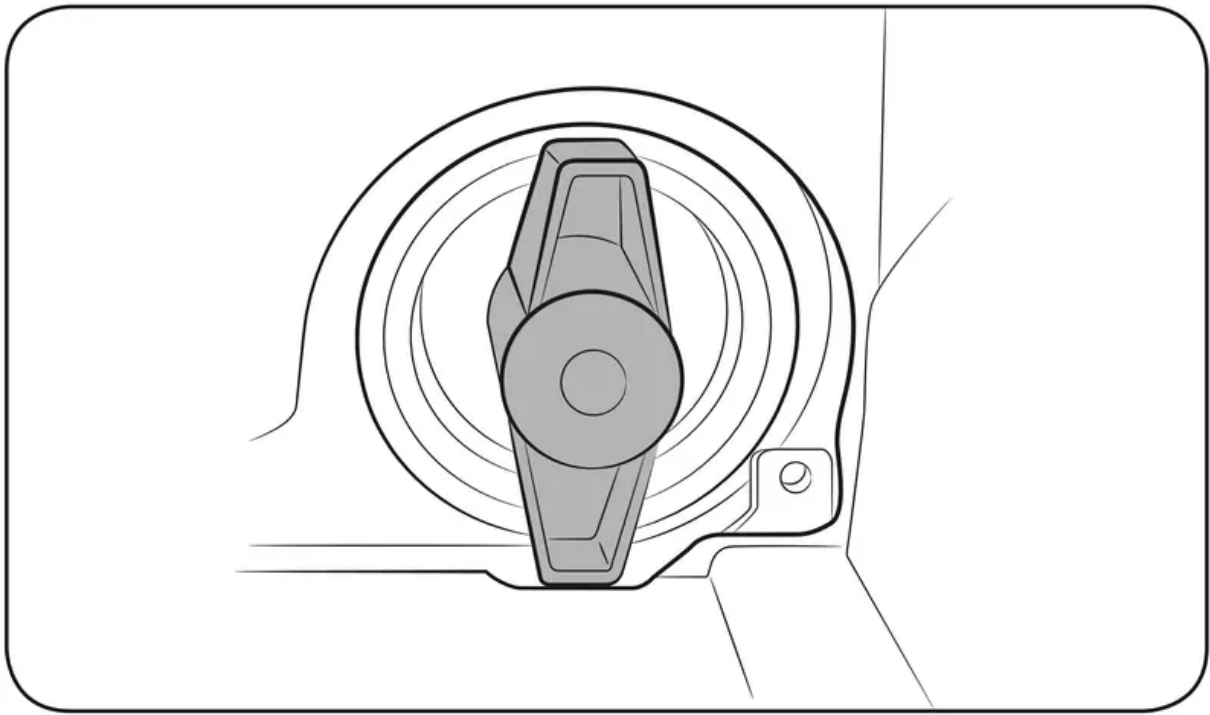

NOTE: If the pump filter is clogged, the "5C" information code appears on the washer's display screen.

CAUTION



- Make sure the filter knob is closed properly after cleaning the filter. Otherwise, this may cause a leak.
- Make sure the filter is inserted properly after cleaning it. Otherwise, this may cause an operational failure or a leak.

Troubleshooting

Checkpoints

If you encounter an issue to check with the washer, first check the table below and try the suggestions.

| Problem | Action |
|---|---|
| Does not turn on. | <ul style="list-style-type: none"> • Make sure your home electrical system is providing electrical power that matches the requirements of the washer. See page 19 • Make sure the power plug of the washer is completely plugged in. |
| Does not start. | <ul style="list-style-type: none"> • Make sure the door is properly closed. • Make sure the taps are open. • Make sure to tap and hold  to start the washer. • Make sure Child Lock is not activated. • Before the washer starts to fill, it will make a series of clicking noises to check the door lock and does a quick drain. • Check the fuse or reset the circuit breaker. • Check if the upper or lower washer displays an information code on the respective status bar. |
| Water supply is insufficient or no water is supplied. | <ul style="list-style-type: none"> • Fully open the tap. • Make sure the door is properly closed. • Make sure the water supply hose is not frozen. • Make sure the water supply hose is not kinked or clogged. • Make sure there is sufficient water pressure. |
| After a cycle, detergent remains in the detergent drawer. | <ul style="list-style-type: none"> • Make sure the washer is running with sufficient water pressure. • If you are using powdered detergent, do not use more than recommended. • If you are using liquid detergent, do not over fill the liquid detergent compartment. • Remove the liquid detergent and softener containers, and then clean the detergent drawer. |
| Excessive vibrations or makes noise. | <ul style="list-style-type: none"> • Make sure the washer is installed on a level, solid floor that is not slippery. If the floor is not level, use the leveling feet to adjust the height of the washer. |

| Problem | Action |
|-----------------------------|---|
| | <ul style="list-style-type: none"> • Make sure the shipping bolts are removed. • Make sure the washer is not contacting any other object. • Make sure the laundry load is balanced. • The motor can cause noise during normal operation. • Overalls or metal-decorated clothes can cause noise while being washed. This is normal. • Metal objects such as coins can cause noise. After washing, remove these objects from the drum or tub or filter case. |
| Does not drain and/or spin. | <ul style="list-style-type: none"> • Make sure the drain hose is neither kinked nor obstructed all the way to the drain system. If there is a drain restriction, call for service. • Make sure the debris filter is not clogged. • Close the door and tap and hold . For your safety, the washer will not tumble or spin unless the door is closed. • Make sure the drain hose is not frozen or clogged. • Make sure the drain hose is connected to a drain system that is not clogged. • If the washer is not supplied with sufficient power, the washer temporarily will not drain or spin. As soon as the washer regains sufficient power, it will operate normally. |
| Drains with noise. | <ul style="list-style-type: none"> • At the initial installation, or when the washer has not been used for an extended period of time, the washer may make deflating noises while draining. This is not a system failure. |
| The door does not open. | <ul style="list-style-type: none"> • Tap  to stop the washer. • It may take a few moments for the door lock mechanism to disengage. • The door will not open until 3 minutes after the washer has stopped or the power has been turned off. • Make sure all the water in the drum or tub is drained. • The door may not open if water remains in the drum or tub. Drain the drum or tub and open the door manually. |

| Problem | Action |
|--|---|
| | <ul style="list-style-type: none"> • Make sure the door lock icon is off. The door lock icon turns off after the washer has drained. |
| Excessive suds. | <ul style="list-style-type: none"> • Make sure you use the recommended types of detergent. • Use high efficiency (HE) detergent to prevent oversudsing. • Reduce the detergent amount for soft water, small loads, or lightly soiled loads. • Non-HE detergent is not recommended. |
| Cannot add additional detergent. | <ul style="list-style-type: none"> • Do not fill the detergent or fabric softener compartments beyond the marked max fill limit. |
| The washer stops. | <ul style="list-style-type: none"> • Plug the power cord into a live electrical outlet. • Check the fuse or reset the circuit breaker. • Close the door, and then tap and hold to start the washer. For your safety, the washer will not tumble or spin unless the door is closed. • Before the washer starts to fill, it will make a series of clicking noises to check the door lock and does a quick drain. • There may be a pause or soak period in the cycle. Wait and the washer may start. • Make sure the mesh filters of the water supply hoses at the taps are not clogged. Periodically clean the mesh filters. • If the washer is not supplied with sufficient power, the washer temporarily will not drain or spin. As soon as the washer regains sufficient power, it will operate normally. |
| The washer fills with the wrong temperature water. | <ul style="list-style-type: none"> • Fully open both taps. • Make sure the temperature selection is correct. • Make sure the hoses are connected to the correct taps. Flush the water lines. • Make sure your water heater is set to supply hot water with a minimum temperature of 120 °F (49 °C) at the tap. Also, check the water heater capacity and recovery rate. |



| Problem | Action |
|---|---|
| | <ul style="list-style-type: none"> • Disconnect the hoses and clean the mesh filters. The mesh filters may be clogged. • While the washer fills, the water temperature may change as the automatic temperature control feature checks the incoming water temperature. This is normal. • While the washer fills, you may notice just hot and/or just cold water going through the dispenser when cold or warm temperatures are selected. This is a normal function of the automatic temperature control feature as the washer determines the water temperature. |
| The load is wet at the end of a cycle. | <ul style="list-style-type: none"> • Use the High or Extra High spin speed. • Use high efficiency (HE) detergent to reduce oversudsing. • The load is too small. Small loads (one or two items) may become unbalanced and not spin completely. • Make sure the drain hose is not kinked or clogged. |
| Leaks water. | <ul style="list-style-type: none"> • Make sure the door is properly closed. • Make sure all hose connections are tight. • Make sure the end of the drain hose is correctly inserted and secured to the drain system. • Avoid overloading. • Use high efficiency (HE) detergent to prevent oversudsing. |
| Has odors. | <ul style="list-style-type: none"> • Excessive suds collect in recesses and can cause foul odors. • Run cleansing cycles to sanitize periodically. • Clean the door seal (diaphragm). • Dry the washer interior after a cycle has finished. |
| The tub or the water/drainhose is frozen. | <ul style="list-style-type: none"> • For frozen hoses, use warm water to disconnect the frozen hoses. Soak them in warm water. • For a frozen tub, fill the tub with warm water, and then wait for about 10 minutes. |

| Problem | Action |
|-------------------------------|---|
| | <ul style="list-style-type: none"> • For the hose connector, put a hot towel on the drain hose connector. • After thawing the hoses, reconnect them. |
| Water drains out immediately. | <ul style="list-style-type: none"> • Make sure the drain hose is not clogged, and is hung over the drain hose hook. Fill the tub halfway with water, and try spinning again. • Lift the end of the drain hose to prevent water from draining. • Fill the tub halfway with water, and then run the spin cycle after releasing the drain hose. • Make sure the drain hose is installed correctly. See the installation section of this manual and then adjust the position of the drain hose as instructed. • Make sure the washer drains completely if it is turned off by force. If you operate the washer before it has drained completely, the washer may supply water and drain simultaneously. |

Information codes

If the washer fails to operate, you may see an information code on the screen. Check the table below and try the suggestions.



| Code | | Action |
|--|--------------|--|
| Upper washer | Lower washer | |
| Close door and restart | | <p>The door is open.</p> <ul style="list-style-type: none"> • Close the door, and then press Start/Pause to resume operation. |
| Clean drain filter | | <p>Check the drain system.</p> <ul style="list-style-type: none"> • Make sure the drain filter is not clogged. • If the drain filter is clogged, clean the filter, and then restart the washer. |
| Check water supply faucets and restart | | <p>Check the water supply line.</p> <ul style="list-style-type: none"> • Check the connection to the water line (including water taps). • Power off and then power the washer on after 2-3 minutes, and then try again. • Depending on the model, the drain system drains water automatically. The Power and Start/Pause buttons may be disabled during this process. |
| Check water lines | | <ul style="list-style-type: none"> • Make sure the cold water supply hose is firmly connected to the cold water tap. If it is connected to the hot water tap, the laundry may be deformed with some cycles. |
| Redistribute unbalanced load and restart | | <p>Check the spinning process.</p> <ul style="list-style-type: none"> • The load may not be balanced inside the drum or tub. Load is too small, or heavy items are mixed with light items. Check the drum or tub and make sure the load is balanced. • Avoid washing single items, adding few extra items help to balance the load. Redistribute the load evenly. • Press Start/Pause to resume operation, or power off and then power the washer on after 2-3 minutes, and then try again. |

| | | |
|------------------------------------|------------|--|
| Close protective cover and restart | | <p>The protective cover is open.</p> <ul style="list-style-type: none"> • Close the protective cover, and then press Start/Pause to resume operation. |
| 1 1C | 1C | <p>Check the water level sensor.</p> <ul style="list-style-type: none"> • Power off and then power the washer on after 2-3 minutes, and then try again. • Depending on the model, the drain system drains water automatically. The Power and Start/Pause buttons may be disabled during this process. |
| 1 dC1 | dC1 | <p>Check the door switch..</p> <ul style="list-style-type: none"> • Power off and then power the washer on after 2-3 minutes, and then try again. |
| 1 LC | LC | <p>Check for water leaks.</p> <ul style="list-style-type: none"> • Power the washer off, and then check the drain system for any leaks. Once the leak issue is resolved, power the washer on after 2-3 minutes. • Depending on the model, the drain system drains water automatically. The Power and Start/Pause buttons may be disabled during this process. |
| 1 LC1 | LC1 | <p>Check the drain hose.</p> <ul style="list-style-type: none"> • Make sure the end of the drain hose is placed on the floor. • Make sure the drain hose is not clogged. • If the information code remains, contact a customer service center. <p>Others</p> <ul style="list-style-type: none"> • Use caution not to overfill any of the compartments (main wash/fabric softener/bleach). • Do not spray or use water when cleaning the top door of the upper washer. Use a cloth to wipe up. |

| | | |
|--|---------------------------------------|--|
| 1 HC | HC | <p>Check the washing heater.</p> <ul style="list-style-type: none"> • Power off the washer, and then contact a Samsung customer service center. |
| 1 8C 1 8C1 18C2 | 8C 8C1 8C2 | <p>Check the MEMS sensor.</p> <ul style="list-style-type: none"> • Power off and then power the washer on after 2-3 minutes, and then try again. |
| 1 OC | OC | <p>Water may overflow.</p> <ul style="list-style-type: none"> • Close the water tap, and then call for service. |
| 1 3C | 3C | <p>Check the motor.</p> <ul style="list-style-type: none"> • Power off and then power the washer on after 2-3 minutes, and then try again. |
| 1 AC6 | AC6 | <p>Check the PBA communication status.</p> <ul style="list-style-type: none"> • Power off and then power the washer on after 2-3 minutes, and then try again. |
| 1 9C1 1 9C2 | 9C1 9C2 | <p>The electronic control needs to be checked.</p> <ul style="list-style-type: none"> • Check if power is supplied properly. • If the information code remains, contact a Samsung service center. |
| 1 SF | SF | <p>System failed.</p> <ul style="list-style-type: none"> • Power off the washer, and then contact a Samsung service center. |
| 1 AC | AC | <p>Check communications between main and sub PBAs.</p> <ul style="list-style-type: none"> • Try powering off and restarting the cycle. • If the information code remains, contact a customer service center. |

Warning

This content is compiled from multiple sources and is provided for reference purposes only. It may not be complete or fully applicable to all situations. If you are unable to resolve your issue, please contact the product manufacturer or an authorized service provider for official support.

Document generated by [ManualsFile](#)