

PELONIS User manual Dehumidifier

Dehumidifier DP&DL

Rated voltage: 115V

Frequency: 60Hz

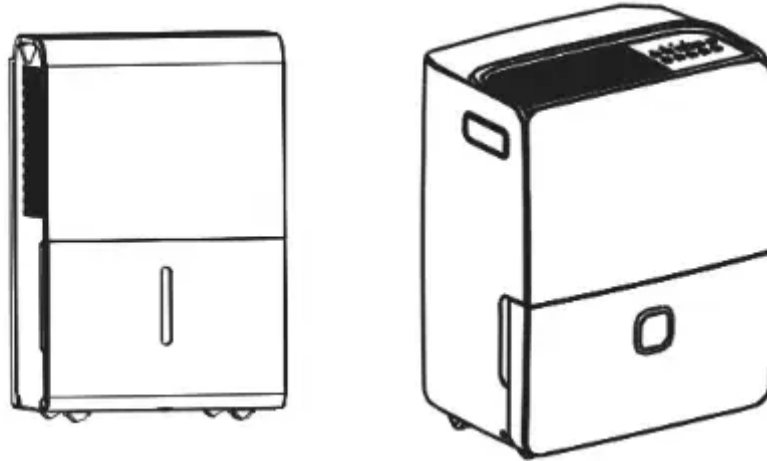

PAD20C1AWT, PAD30C1AWT, PAD40C1AWT, PAD50P1ABL, PAD60P1AGR

Customer service: 1(866) 646-4332

www.pelonis.com

Safety Precautions

To prevent injury to the user or personal and property damage, these instructions must be followed. Incorrect operation due to ignoring of instructions may cause harm or damage. The level of risk is shown by the following indications.

WARNING

- Plug in power plug properly. Otherwise, it may cause electric shock or fire due to excess heat generation.
- Do not modify power cord length or share the outlet with other appliances. It may cause electric shock or fire due to overheating.
- Always ensure effective grounding. Incorrect grounding may cause electric shock.
- Unplug the unit if strange sounds, smells, or smoke come from it. A damaged product may cause fire and electric shock.
- Ventilate room before operating the unit if there is a gas leak from other appliances.
- Do not operate or stop the unit by inserting or pulling out the power plug. It may cause electric shock.
- Do not allow water to enter into electric parts. It may cause failure or electric shock.
- Do not use the power outlet if it is loose or damaged. It may cause fire and electric shock.
- Do not use or keep the power cord close to heating appliances or heat sources such as

fireplaces. It may cause fire and electric shock.

- Do not disassemble or modify unit. It may cause failure and electric shock.
- Do not damage or use an unspecified power cord. It may cause fire and electric shock.
- If the power cord is damaged, it must be replaced by the manufacturer or an authorized service center or a similarly qualified person in order to avoid electrical risk.
- Do not use the unit near flammable gas or combustibles, such as gasoline, benzene, thinner, etc. It may cause fire.
- Before cleaning, turn off the power and unplug the unit.
- Do not remove the water bucket during operation, the bucket full protection may be activated and risk electric shock.

CAUTION

- Do not use the unit in small spaces. Lack of ventilation can cause overheating and fire.
- Do not use in places where water may splash onto the unit. Water may enter the unit and degrade the insulation. It may cause an electric shock or fire.
- Place the unit on a level, sturdy section of the floor.

If the unit falls over, it may cause water to spill and damage belongings, or cause electrical shock or fire.

- Never insert your finger or other foreign objects into grills or openings. Take special care to warn children of these dangers.

It may cause failure or electric shock.

- Do not climb up on or sit on the unit. You may be injured if you fall or if the unit falls over.
- Always insert the filters securely, and take caution to avoid injuries to hand and fingers.

Clean filter once every two weeks.

- If water enters the unit, turn the unit off and disconnect the power, contact a qualified service technician.
- Do not place flower vases or other water containers on top of the unit. Water may spill inside the unit, causing insulation failure and electrical shock or fire.
- If the unit is knocked over during use, turn off the unit and unplug it from the main power supply immediately. Visually inspect the unit to ensure there is no damage. If you suspect the unit has been damaged, contact customer service or a qualified technician.
- In a thunderstorm, the power should be disconnected to the unit due to lightning.
- Do not run power cord under carpeting. Do not cover cord with throw rugs, runners, or similar coverings. Do not route cord under furniture or appliances. Arrange cord away from traffic area and where it will not be tripped over.

WARNING - Electrical Information

- The manufacturer's nameplate is located on the rear panel of the unit and contains electrical and other technical data specific to this unit.

- Be sure the unit is properly grounded. To minimize shock and fire hazards, proper grounding is important. The power cord is equipped with a three-prong grounding plug for protection against shock hazards.
- Your unit must be used in a properly grounded wall receptacle. If the wall receptacle you intend to use is not adequately grounded or protected by a time delay fuse or circuit breaker, have a qualified electrician install the proper receptacle.
- Ensure the receptacle is accessible after the unit installation.
- To avoid the possibility of personal injury, always disconnect the unit from power supply, before installing and/or servicing.

WARNING - For your safety

- Do not store or use gasoline or other flammable vapors and liquids in the vicinity of this or any other appliance.
- Avoid fire hazard or electric shock. Do not use an extension cord or an adaptor plug. Do not remove any prongs from the power cord.

Unit Specifications and Features

Product overview

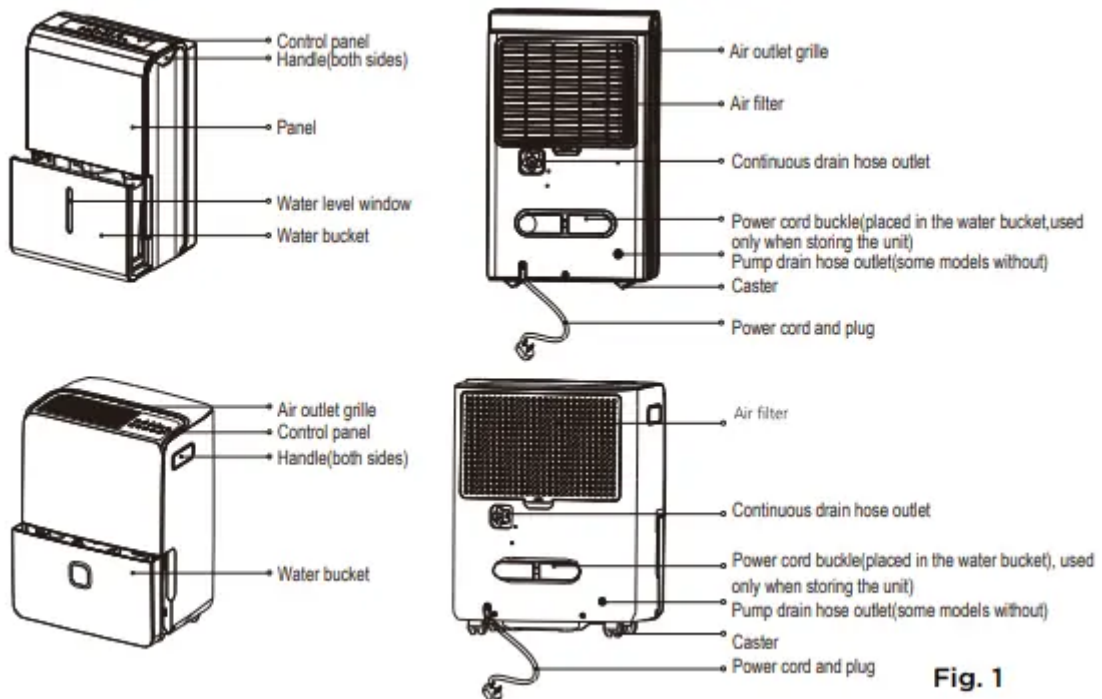
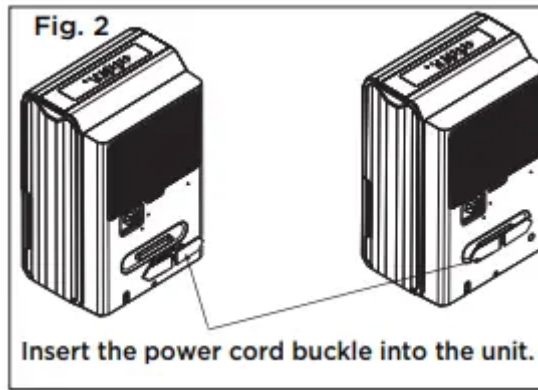

Fig. 1

NOTE: All the pictures in this manual are for illustrative purposes only. The actual shape of the dehumidifier you purchased may be slightly different, but its operations and functions are similar.



Accessories

- Pump drain hose (1 pc) (only for units with the drain pump feature)
- Power cord buckle (1 pc)

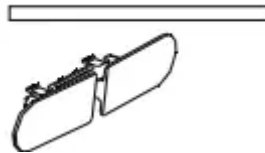

Operating Instructions

CAUTION: Clean your unit occasionally to keep it looking new. Be sure to unplug the unit before cleaning to prevent shock or fire hazards.

Key Pad Features



NOTE: The appearance of the control panel on your unit may vary slightly. Functions will be similar

Control Pads

When you push the button to change operation modes, the unit will make a beep sound to indicate that it is changing modes.



(PUMP) Button: Press to activate the pump operation.

NOTE: Make sure the pump drain hose is installed into the unit and the continuous drain hose is removed from the unit before the pump operation is activated. When the bucket is full, the pump starts to work. Refer to the next pages for removing the collected water. Do not use this operation when the outdoor temperature is equal to or less than 0°C (32°F).



- **(COMFORT) Button** Press to activate the COMFORT dehumidifying operation. The dehumidifier will automatically set to a preset humidity and fan level. To exit comfort mode, adjust the humidity to desired level.
- **(FILTER) Button** This feature is a reminder to clean the Air Filter for more efficient operation. The LED (light) will flash after 250 hours of operation. To reset after cleaning the filter, press the Filter button and the light will go off. The 250 hour counter will reset.
- **(Cont.) Button** Press to activate the continuous dehumidifying operation.



NOTE: When CONTINUOUS mode function is turned on, set humidity is automatic and cannot be changed manually

- (TURBO) Button Control the Turbo speed. Press to select either Turbo or normal fan speed. Set the Turbo control to high for maximum moisture removal. When room humidity is at your preferred level, it is advised to turn off Turbo speed.
- (TIMER) Button Starts the Timer ON and Timer OFF function setting.

• 
Up/Down Buttons ( / )

- Humidity Set Control Buttons The humidity level can be set within a range of 35% RH (Relative Humidity) to 85% RH (Relative Humidity) in 5% increments. For drier air, press

the  button and set to a lower value (%). For damper air, press the  button and set a higher value (%).

- 
TIMER Set Control Buttons Use the  and  key buttons to set the Timer ON or Timer OFF from 0 to 24 hours.
- ION Button(on some models) Press to activate the ionizer. Ions are automatically generated by ionization. The ions deactivate the airborne chemical vapors and dust particles. Press it again to stop the function.

(POWER) Button Press to turn the dehumidifier on and off.

LED Display: Shows the set % humidity level from 35% to 85% or auto start/stop time (0 ~ 24) while setting, then shows the actual (+/- 5% accuracy) room % humidity level in a range of 30% RH (Relative Humidity) to 90% RH (Relative Humidity).

Error Codes and Protection Code:

AS - Humidity sensor error - Unplug the unit and plug it back in. If error persists, contact Customer Service

ES - Tube Temperature sensor of the evaporator error - Unplug the unit and plug it back in. If error persists, contact Customer Service.

P2 - Bucket is full or bucket is not in right position - Empty the bucket and replace it in the right position. (only available for the unit with no pump feature.)

P2 - Bucket is full - Empty the bucket. (only available for the unit with pump feature.)

Eb - Bucket is removed or not in right position - Replace the bucket in the right position. (only available for the unit with pump feature.)

Other Features

Bucket Full Light: Lights up when the bucket is ready to be emptied.

Auto Shut Off : The dehumidifier shuts off when the bucket is full, or when the bucket is removed or not replaced in the proper position. When the set point humidity level is reached, the unit will be shut off automatically. The fan motor will continue operating.

Auto Defrost : When frost builds up on the evaporator coils, the compressor will cycle off and Auto Defrost function will run automatically. 3 minute compressor operation delay protection After the unit has stopped, it can not be restarted in the first 3 minutes to protect compressor operation. The unit will restart automatically after 3 minutes.



Auto-RestartL : If the unit stops unexpectedly due to a power cut, it will restart with the previous function setting automatically when the power resumes.

Setting the Timer ON and Timer OFF

- When the unit is on, first press the Timer button, the Timer OFF indicator light illuminates. It indicates the Timer OFF program is initiated. Press it again the Timer ON indicator light illuminates. It indicates the Timer ON is initiated.
- When the unit is off, first press the Timer button, the Timer ON indicator light illuminates. It indicates the Timer ON program is initiated. Press it again, the Timer OFF indicator light illuminates. It indicates the Timer OFF is initiated.

•



Press or hold the  and  key buttons to change the Timer by 0.5 hour increments, up to 10 hours, then at 1 hour increments up to 24 hours. The control will count down the time remaining until start.

- The selected time will register in 5 seconds and the system will automatically revert back to display the previous humidity setting.
- When the Timer ON and Timer OFF times are set, within the same program sequence, indicator lights illuminate identifying both ON and OFF times are now programmed.
- Turning the unit ON or OFF at any time or adjusting the timer setting to 0.0 will cancel the Timer function.
- When LED display window displays the code of P2, the Auto Start/Stop function will also be canceled

NOTES

- When first using the dehumidifier, operate the unit continuously 24 hours. Make sure the plastic cover on the continuous drain hose outlet install tightly and properly so there are no leaks.

- This unit is designed to operate with a working environment between 5°C/41°F and 32°C/90°F.
- Make sure the water bucket is positioned correctly so that the unit can operate properly. When the water in the bucket reaches a certain level, please be careful while moving the unit to avoid it spill

Removing Collected Water

There are three ways to remove collected water:

1. Use the bucket

- When the unit is off, if the bucket is full, the Full indicator light will light.
- When the unit is on, if the bucket is full, the compressor and the fan turn off, and the Full indicator light will light, the digital display shows P2.
- Slowly pull out the bucket. Grip the left and right handles securely, and carefully pull out straight so water does not spill. Do not put the bucket on the floor as because the bottom of the bucket is uneven. Otherwise water may be spilled.
- Empty the water and reposition the bucket.
- The unit will restart operation when the bucket is back in place.

1. Pull out the bucket.

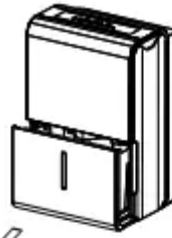

2. Hold both sides of the bucket evenly, and pull it out from the unit.

Fig. 5

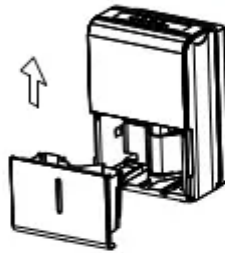

3. Pour the water out.

Fig. 6

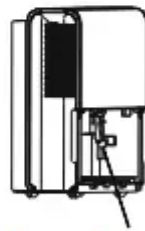

Pump hose drops

Fig. 7

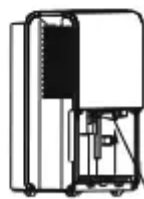

Reinstall pump
hose properly

Fig. 8

NOTES

- When you remove the bucket, do not touch any parts inside the unit. Doing so may damage the product.
- Be sure to push the bucket gently all the way into the unit.

- If the pump hose falls off when you remove the bucket (see Fig. 7), you must reinstall the pump hose properly to the unit before replacing the bucket into the unit (see Fig. 8).
- When the unit is on, if the bucket is removed, the compressor and the fan turn off, then the unit will beep 8 times and the digital display shows Eb.
- When the unit is off, if the bucket is removed, the unit will beep 8 times and the digital display shows Eb.

2. Continuous draining

- Water can be automatically emptied into a floor drain by attaching the unit with a standard garden hose thread to the back of the dehumidifier. The hose should have an outside diameter 5/8 inch or greater. Garden hose is not included.
- Remove the plastic cover from the back drain outlet of the unit and set aside, then insert the drain hose through the drain outlet of the unit and lead the drain hose to the floor drain or a suitable drain facility. (See Fig. 9 and Fig. 10)
- When you remove the plastic cover, if there is some water in the back drain outlet of the unit you must dry it. Make sure the hose is secure so there are no leaks and the end of the hose is level or sloping downwards to let the water flow.
- Direct the hose toward the drain, making sure that there are no kinks that will stop the water flowing.
- Select the desired humidity setting and fan speed on the unit for continuous draining to start.

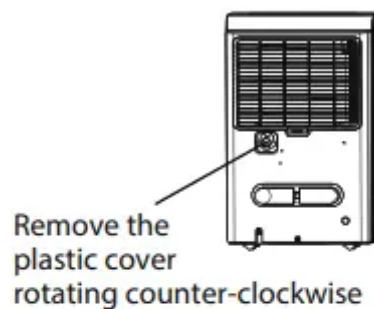

Fig. 9

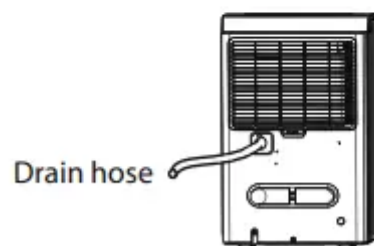

Fig. 10

NOTE: When the continuous draining feature is not being used, remove the drain hose from the outlet, and dry the water in the continuous drain hose outlet using a dry cloth.

3. Pump draining (Pump models only)

Water can be automatically emptied into a floor drain or a suitable drainage facility by attaching the pump drain out with a pump drain hose (\varnothing od = 1/4", supplied).

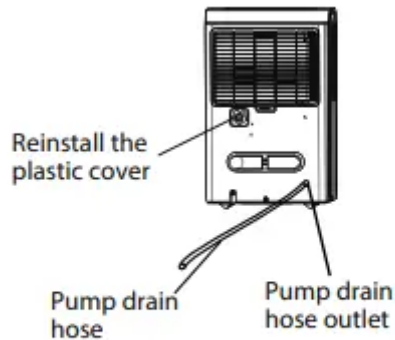

Fig. 11

- Remove the continuous drain hose from the unit and install the plastic cover to the continuous drain hose outlet of the unit by clockwise rotation. (See Fig. 11)
- Insert the pump drain hose into the pump drain hose outlet for at least 15 mm (See Fig. 11), then lead the water hose to the floor drain or a suitable drainage facility.
- Press the pump pad on the unit to activate the pump operation. When the bucket is full, the pump starts to work.
- By using the internal pump operation (hose also included) pump unit can pump water vertically up to 16 feet .

NOTE: The pump may generate a loud noise for the first 3~5 minutes of operation.

- Make sure the hose is secure so there are no leaks.
- Direct the hose toward the drain, making sure that there are no kinks that will stop the water flowing.
- Place the end of the hose into the drain.
- Select the desired humidity setting and fan speed on the unit for pump draining to start.

NOTE: The pump operation light blinks when a failure occurs. Please turn off the unit and disconnect the power cord. Check the following items:

- Cleaning the pump filter: Remove the bucket from the unit, take out the pump, and clean the pump filter (See Fig. 12).
- Check if the drain hose is clean and free of debris.
- Empty the water from the bucket.

- Check the hose connection and the bucket for proper assembly. If the error persists, contact Customer Service.

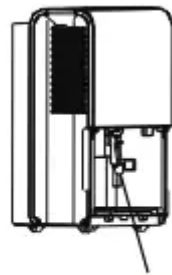

Filter of the pump

Fig. 12

NOTE: Do not use the pump operation when the outdoor temperature is equal to or less than 0°C (32°F), otherwise ice may form, blocking the hose and causing the unit to stop operating. Make sure to empty the bucket at least once a week when using the pump draining feature. When the pump draining feature is not being used, remove the pump drain hose from the outlet.

Installation Instructions

Positioning the Unit

A dehumidifier operating in a basement will have little or no effect in drying an adjacent enclosed storage area, such as a closet, unless there is adequate circulation of air in and out of the area. (See Fig. 13)

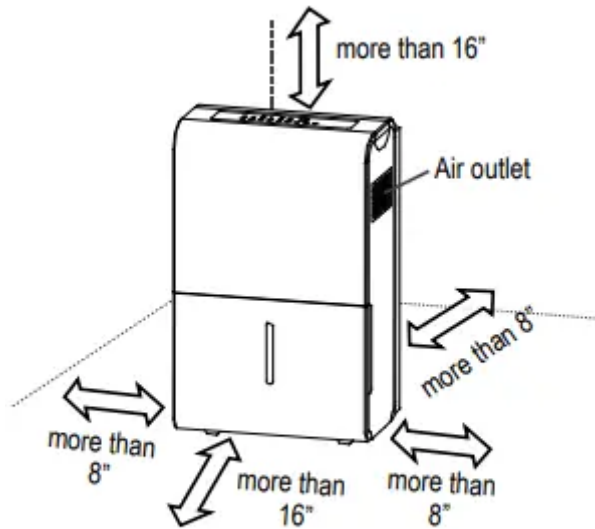

Fig. 13

- Do not use outdoors.
- This dehumidifier is intended for indoor residential applications only. This dehumidifier should not be used for commercial or industrial applications.
- Place the dehumidifier on a smooth, level floor strong enough to support the unit with a full bucket of water.
- Allow at least 8" of air space on all sides of the unit for air circulation (at least 16" for air outlet).
- Place the unit in an area where the temperature will not fall below 41°F (5°C). The coils can become covered with frost at lower temperatures, which may reduce performance.
- Place the unit away from any clothes dryer, heater or radiator.
- Close all doors, windows and other outside openings to the room.

Care and Cleaning

Turn the dehumidifier off and disconnect the plug from the power source before cleaning.

1. Clean the Grill and Case

- Use water and a mild detergent. Do not use bleach or abrasives.
- Do not splash water directly onto the unit. Doing so may cause an electrical shock, cause the insulation to deteriorate, or cause the unit to rust.
- The air intake and outlet may get dirty during operation, use a vacuum cleaner or brush to clean.

2. Clean the bucket

Every few weeks, clean the bucket thoroughly to prevent growth of mold, mildew and bacteria. Partially fill the bucket with clean water and mild detergent. Swish it around in the bucket, empty and rinse.

NOTE: Do not use a dishwasher to clean the bucket.

3. Clean the air filter

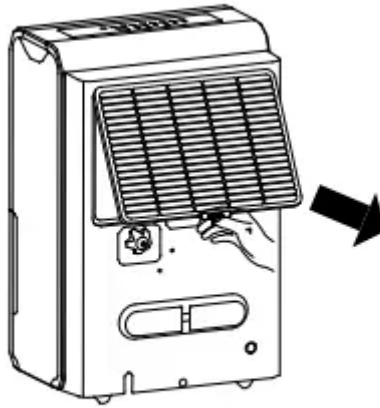

Fig. 14

- To remove the filter, pull filter outwards (See Fig. 14).
- Wash the filter with clean water then dry.
- Re-install the filter, replace bucket.

CAUTION: DO NOT operate the dehumidifier without a filter to avoid loss of performance and damage to the unit.

4. When not using the unit for long time periods

- Before storing the unit, let it rest for one full day so that the system can dry out naturally.
- Clean the unit, water bucket and air filter.
- Wrap the cord with the power cord buckle.
- Store the unit upright in a dry, well-ventilated area.

Troubleshooting Tips

Before calling for service, review this list. It may save you time and money. This list includes common occurrences that are not the result of defective workmanship or materials in this appliance.

1. Unit does not start

- Make sure the dehumidifier's plug is connected firmly into the wall outlet.
- Check the house fuse/circuit breaker box.

- Dehumidifier has reached its present level or bucket is full. Empty the bucket and dump.
 - Water bucket is not in the proper position. Please follow the guidelines found on page 10 for re-inserting the bucket into the proper position.
2. Dehumidifier does not dry the air as it should
 - Not enough time to remove the moisture. Allow unit to continue running.
 - Make sure there are no curtains, blinds or furniture blocking the front or back of the dehumidifier. The humidity control may not be set low enough.
 - Check that all doors, windows and other openings are securely closed.
 - The room temperature could be too low (below 5°C or 41°F). In that case, the room will need to warm up before the dehumidifier can properly function so restart the unit once the room is above that desired temperature.
 - There is a water vapor source in the room causing the humidity to constantly increase. This will cause the unit to always run and seemingly not reach the desired humidity. If that's the case, we recommend removing the additional water source or recognize that the unit may still be functioning correctly.
 3. The unit makes a loud noise when operating
 - Air filter may be dirty. Clean filter. Refer to Care and Cleaning section.
 - The unit is tilted instead of upright, so make sure the unit is level before operating.
 - The floor surface is not level, so relocate the unit to a level area or place something under the unit to help level it.
 4. Frost appears on the coils
 - This is normal. The dehumidifier has Auto defrost feature.
 5. Water on floor
 - Hose connection may be loose, so check them and tighten any that seem loose.
 - If intending to use the bucket to collect water, the drain plug may be removed, so check the drain plug and attach if necessary.
 6. ES, AS, P2, EC, Eb and E3 appear in the display
 - These are error codes and protection code. Check Operating Instructions
 7. The pump operation on light blinks at 1Hz
 - Clean the pump filter.
 - Check the pump hose is not blocked or leaking.
 - Empty the water bucket

Warning

This content is compiled from multiple sources and is provided for reference purposes only. It may not be complete or fully applicable to all situations. If you are unable to resolve your issue, please contact the product manufacturer or an authorized service provider for official support.

Document generated by [ManualsFile](#)