

PARTS & ACCESSORIES

PARTS

A. Reversible Rack

B. Cook & Crisp™ Basket

C. Detachable Diffuser

D. Removable 6L

Cooking Pot

E. Crisping Lid

F. Heat Shield

G. Control Panel

H. Cooker Base

I. Pressure Lid

J. Pressure Release Valve

K. Float Valve

L. Silicone Ring

M. Anti-Clog Cap

N. Air Socket Vent

O. Condensation Collector

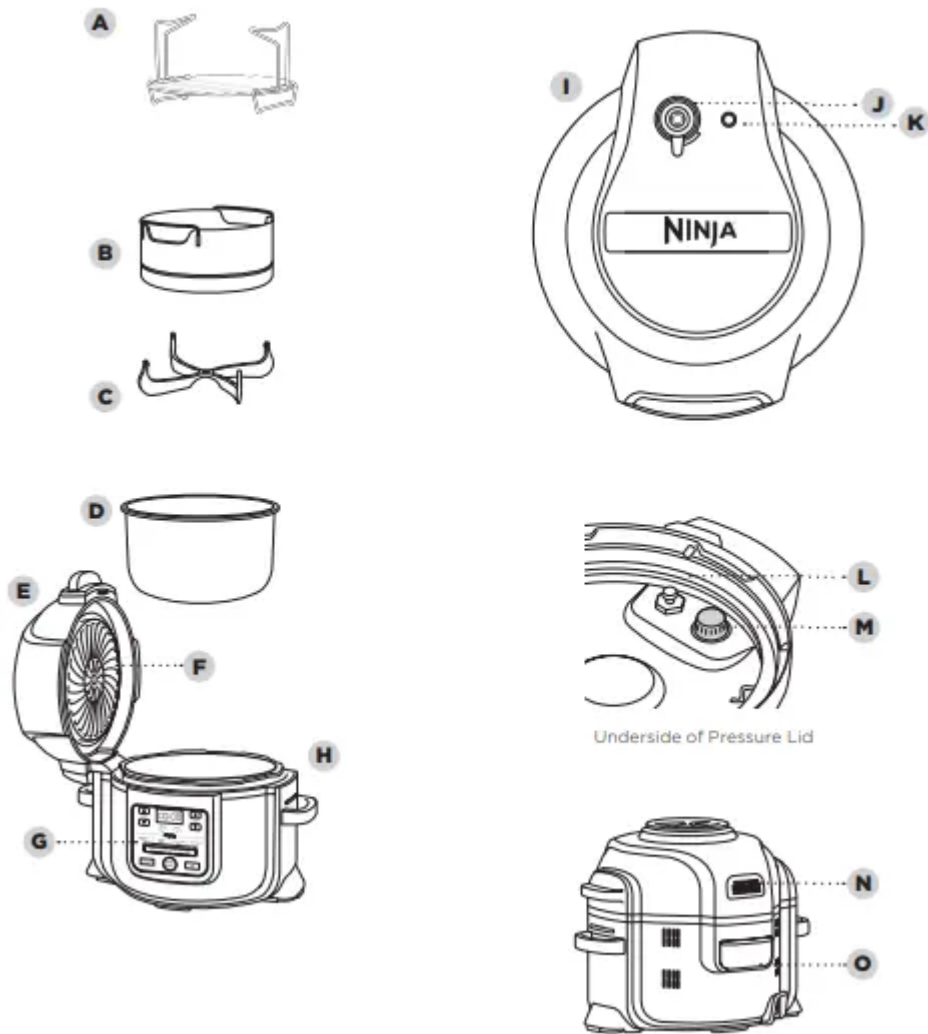

ACCESSORIES (SOLD SEPARATELY)

P. Cook & Crisp™ Layered Insert

Q. Multi-Purpose Pan

R. Roasting Rack Insert

S. Dehydrating Rack

T. Loaf Pan

U. Crisper Pan

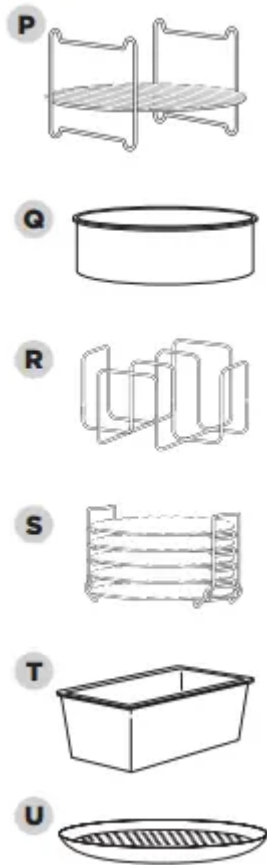

USING THE CONTROL PANEL

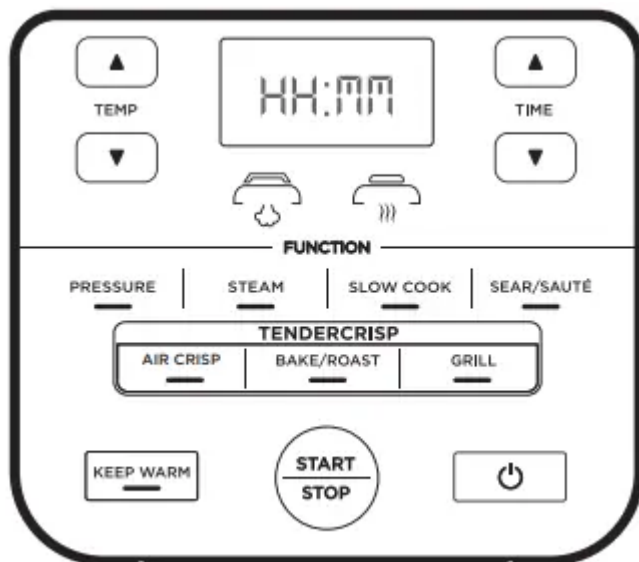

NOTE: Control panel may differ per model.

FUNCTION BUTTONS

PRESSURE: Use to cook food quickly while maintaining tenderness.

STEAM: Use to gently cook delicate foods at a high temperature.

SLOW COOK: Cook your food at a lower temperature for longer periods of time.

SEAR/SAUTÉ: To use the unit for browning meats, sautéing vegetables, simmering sauces and more.

AIR CRISP: To use the unit as an air crisper to give foods crispiness and crunch with little to no oil.

BAKE/ROAST: To use the unit as an oven for tender meats, baked treats and more.

GRILL: Use to caramelize and brown your food.

OPERATING BUTTONS

TEMP arrows: Use the up and down TEMP arrows to adjust the cook temperature and/or pressure level.

TIME arrows: Use the up and down TIME arrows to adjust the cook time.

NOTE: While cooking, to adjust temp or time, use the up and down arrows. The unit will then resume at those settings.

START/STOP button: After selecting your cooking temperature (or pressure) and cooking time. Press the START/STOP button to begin the cooking process. This can be stopped by pressing the button which the unit is in operation.

KEEP WARM button: After pressure cooking, steaming, or slow cooking, the unit will automatically switch to Keep Warm mode and start counting up. Keep Warm will stay on for 12 hours, or you may press KEEP WARM to turn it off. Keep Warm mode is not intended to warm food from a cold state but to keep it warm at a foodsafe temperature.



The Power button turns off the unit and stops all cooking.

STANDBY mode: After 10 minutes with no interaction with the control panel, the unit will enter standby mode.

BEFORE FIRST USE

1. Remove and discard any packaging material, promotional labels, and tape from the unit.
2. Remove all accessories from the packaging and read this manual carefully. Please pay particular attention to operational instructions, warnings, and important safeguards to avoid any injury or property damage.
3. Wash the pressure lid, Silicone ring, removable cooking pot, Cook & Crisp™ Basket, reversible rack and condensation collector in hot, soapy water, then rinse and dry thoroughly.

4. NEVER clean the cooker base in the dishwasher. Inspect the pressure lid to ensure there is no debris blocking the valves.
5. The Silicone ring is reversible and can be inserted in either direction. Insert the Silicone ring around the outer edge of the Silicone ring rack on the underside of the lid. Ensure it is fully inserted and lies flat under the Silicone ring rack.

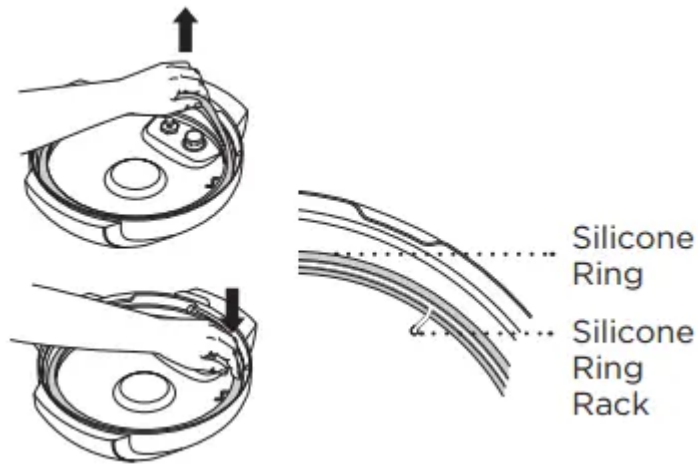

INSTALLING THE CONDENSATION COLLECTOR

To install the condensation collector, slide it into the slot on the cooker base. Slide it out to remove it for hand-washing after each use.

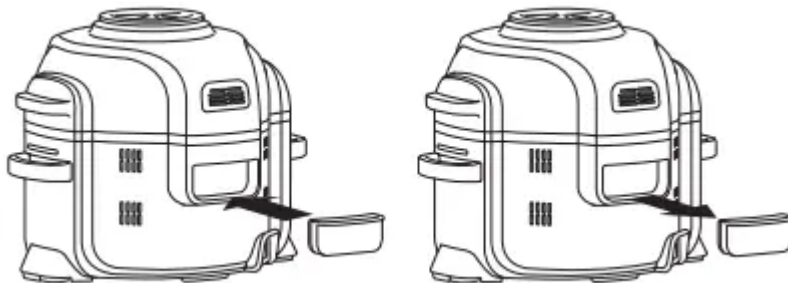

REMOVING & REINSTALLING THE ANTI-CLOG CAP

Make sure your anti-clog cap is in the correct position before using the pressure lid. The anti-clog cap protects the inner valve of the pressure lid from clogging and protects users from potential food splashes. It should be cleaned after every use with a cleaning brush. To remove it, squeeze and pull upward. To reinstall, position it in place and press down.



NOTE: Prior to each use, make sure the Silicone ring is well seated in the Silicone ring rack and the anti-clog cap is mounted properly on the pressure release valve.

USING YOUR NINJA® FOODI® TENDERCRISP® MULTI-COOKER

SWAP THE TOP

The two lids allow you to seamlessly transition between all your favourite cooking methods. Use the pressure lid to tenderise, then use the crisping lid to crisp up your food.

USING THE CRISPING LID

The crisping lid is attached to the unit and can be opened at any time to check on your food during the cooking process. When the lid is opened, the timer will pause, and the heating element will turn off. When the lid is closed, cooking will begin again and the timer will resume counting down.

USING THE COOKING FUNCTIONS WITH THE CRISPING LID

To turn on the unit, plug the power cord into a socket, then press the Power button.

Air Crisp

1. Press the AIR CRISP button. The default temperature setting will display. Use the up and down TEMP arrows to choose a temperature between 150°C and 200°C.



2. Use the up and down TIME arrows to set the cook time in minute increments up to 1 hour.



3. With the pot installed, place either the Cook & Crisp™ Basket or reversible rack in the pot. Basket must have the diffuser attached.

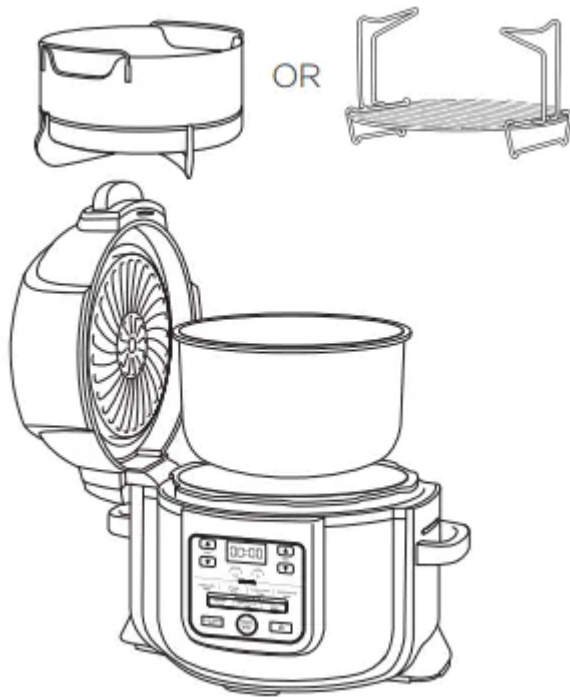

NOTE: It is recommended to let the unit preheat for 5 minutes before adding ingredients. When preheating, before step 4, close the lid, and press the START/STOP button to begin.

4. Add ingredients to the Cook & Crisp™ Basket or reversible rack. Close the lid and press the START/STOP button to begin cooking.

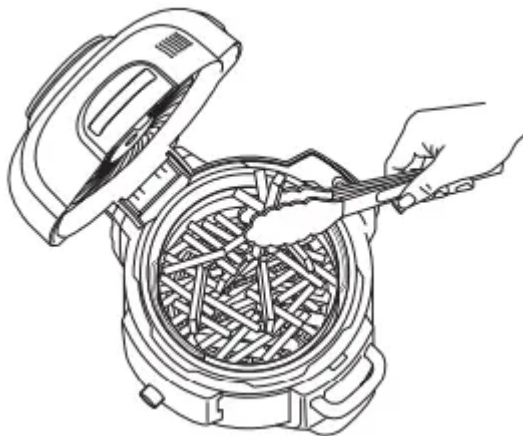

5. During cooking, you can open the lid and lift out the basket to shake or toss ingredients for even browning, if needed. When done, lower basket back into pot and close lid. Cooking will automatically resume after lid is closed.



NOTE: If you press the STOP during Air Crisp Mode, the unit will wait 10 seconds before entering Standby mode.

6. When cooking is complete, the unit will beep.

Bake/Roast

1. Press the BAKE/ROAST button. The default temperature setting will display. Use the up and down TEMP arrows to choose a temperature between 150°C and 200°C.



2. Use the up and down TIME arrows to set the cook time in minute increments up to 1 hour, 5-minute increments from 1 hour to 4 hours.

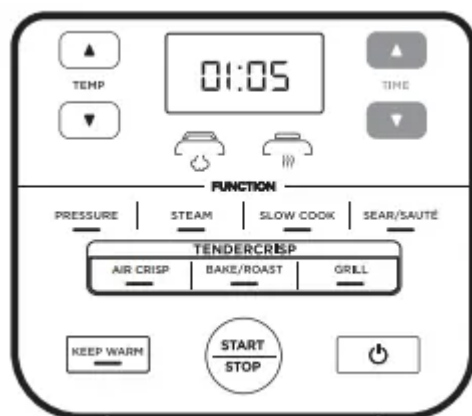

NOTE: If running for 1 hour or less, the clock will count down by minutes and seconds. If running for more than 1 hour, the clock will count down by minutes only

NOTE: It is recommended to let the unit preheat for 5 minutes before adding ingredients. If preheating, before step 3, close the lid, and press the START/STOP button to begin.

3 Add ingredients, along with any accessories called for in your recipe, to the pot. Close the lid and press the START/STOP button to begin cooking.

4 When cooking is complete, the unit will beep.

Grill

1. Press the GRILL button.

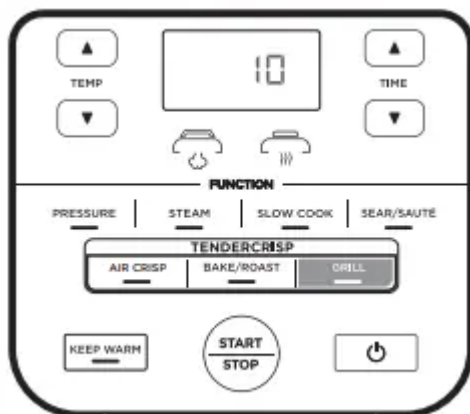

NOTE: There is no temperature adjustment available or necessary when using the Grill function.

2. Use the up and down TIME arrows to set the cook time in minute increments up to 30 minutes.

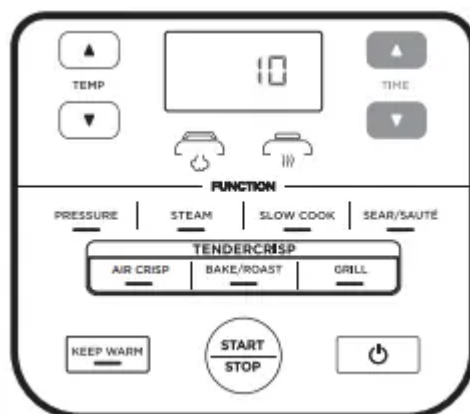

3. Place the reversible rack in the pot in the upper grill position or follow directions per recipe.



4. Place ingredients on the rack, then close the lid.



5. Press the START/STOP button to begin cooking.

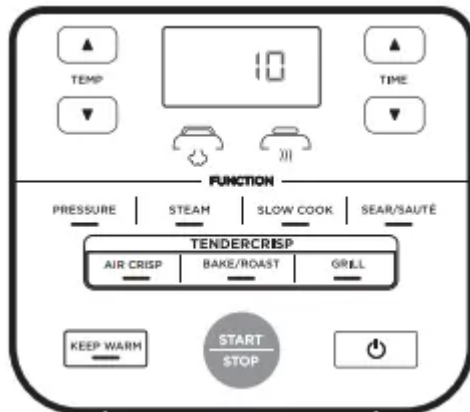

6. When cooking is complete, the unit will beep.



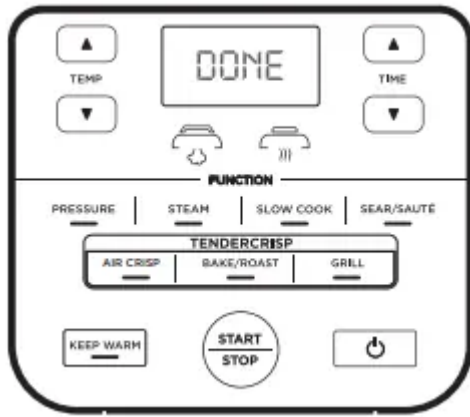

PRESSURE TEST

FAMILIARISING YOURSELF WITH PRESSURE COOKING

In order to familiarise yourself with the Pressure Cook function and start cooking, it is highly recommended for first-time users to do an initial run with water only.

1. Place the pot in the cooker base and add 700ml room-temperature water to the pot.



2. Assemble the pressure lid by aligning the arrow on the front of the lid with the arrow on the front of the cooker base. Then turn the lid clockwise until it locks into place.



3. Make sure the pressure release valve on the lid is in the SEAL position.



4. Turn the unit on. Press the PRESSURE button, the unit will default to high (HI) pressure. Set the time to 2 minutes. Press the START/STOP button to begin.

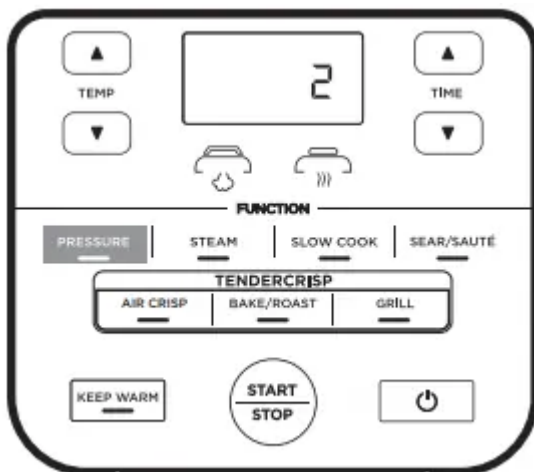

5. Your Ninja® Foodi® Multi-Cooker will begin to build pressure, indicated by the rotating lights. The unit will begin counting down when it is fully pressurised.

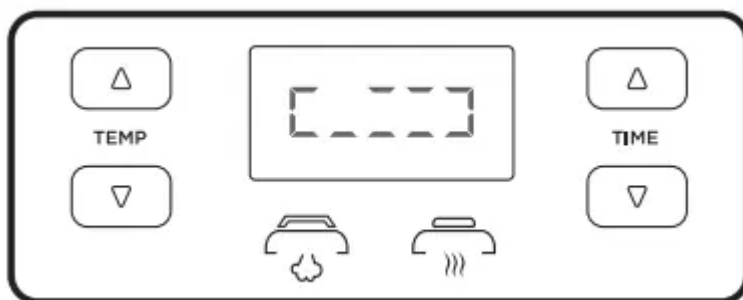

6. When the countdown is finished, the Ninja® Foodi® Multi-Cooker will beep, automatically switch to the Keep Warm mode, and begin counting up.



7. Turn the pressure release valve to the VENT position to quick release the pressurised steam. A quick burst of steam will spurt out of the pressure release valve. When steam is completely released, the unit will be ready to open.



NOTE: To maintain the quick release pressure, the valve will lock in to place in the VENT position.

NATURAL PRESSURE RELEASE VS. QUICK PRESSURE RELEASE

Natural Pressure Release: When pressure cooking is complete, steam will naturally release from the unit as it cools down. This can take up to 20 minutes or more, depending on the amount of liquid and food in the pot. During this time, the unit will switch to Keep Warm mode. Press the KEEP WARM button if you would like to turn Keep Warm mode off. When natural pressure release is complete, the float valve will drop down.

Quick Pressure Release: Use ONLY if your recipe calls for it. When pressure cooking is complete and the KEEP WARM light is on, turn the pressure release valve to the VENT position to instantly release pressure through the valve.

Even after releasing pressure naturally or using the pressure release valve, some steam will remain in the unit and will escape when the lid is opened. Lift and tilt it away from you, making sure no condensation drips into the cooker base.



NOTE: At any time during the natural release process, you can switch to quick release by turning the pressure release valve to the VENT position.

WARNING: Caution HOT Steam emitted.

PRESSURISING

As pressure builds in the unit, the control panel will display rotating lights. Pressurising time varies, depending on the amount of ingredients and liquid in the pot. As the unit pressurises, the lid will lock as a safety measure, and it will not unlock until pressure is released. Once the unit has reached full pressure, the lid pressure icon light will glow steadily. The pressure cooking cycle will begin and the timer will start counting down.

INSTALLING & REMOVING THE PRESSURE LID

Place the pressure lid on top of the unit with the  on the lid and the  on the base lined up evenly. Turn the lid clockwise until it locks in place.

To unlock the pressure lid, turn it counterclockwise. Lift the lid at an angle to prevent splatter. Do not lift the lid straight up.

NOTE: The pressure lid will not unlock until the unit is completely depressurised.

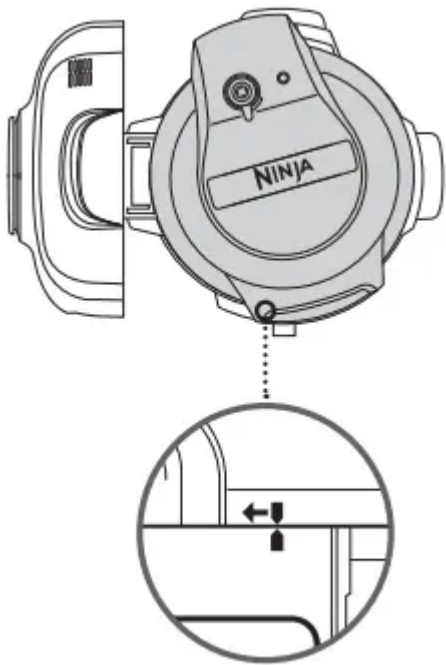

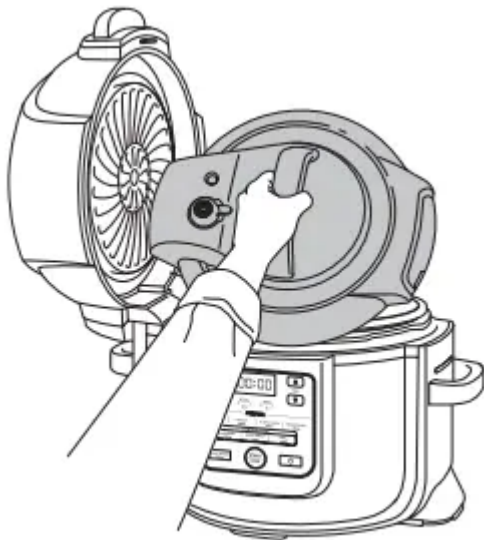
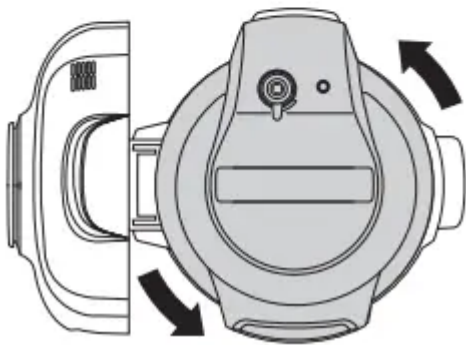
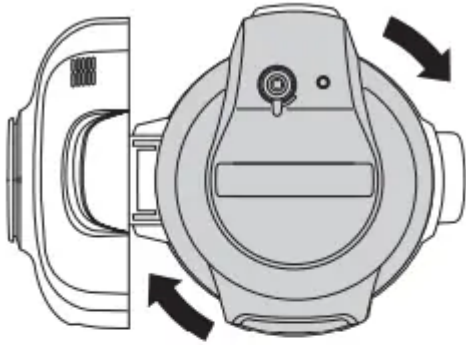

WARNING: Serious burns can result from the steam inside. ALWAYS lift and tilt the lid towards you when removing.

USING THE COOKING FUNCTIONS WITH THE PRESSURE LID

To turn on the unit, plug the power cord into a socket, then press the Power button.

Pressure Cook

1. Place ingredients and at least 200ml of liquid in the pot, including an accessory if your recipe calls for it. DO NOT exceed the line marked PRESSURE MAX when pressure cooking.

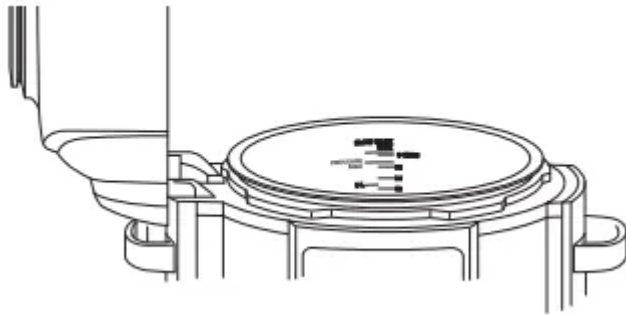

NOTE: When cooking rice, beans, or other ingredients that expand, DO NOT fill the pot more than halfway.

2. Follow the steps on page 16 to install the pressure lid. Turn the pressure release valve to the SEAL position.



3. Press the PRESSURE button. The default pressure level will display. Use the up and down TEMP arrows to select either HIGH or LOW.

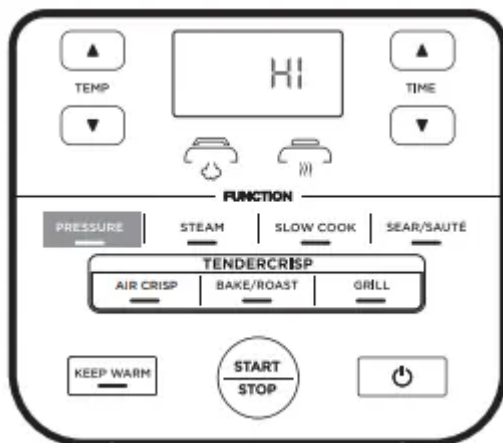

NOTE: If running for 1 hour or less, the clock will count down by minutes and seconds. If running for more than 1 hour, the clock will count down by minutes only.

4. Use the up and down TIME arrows to set the cook time in minute increments up to 1 hour, and in 5-minute increments from 1 hour to 4 hours.

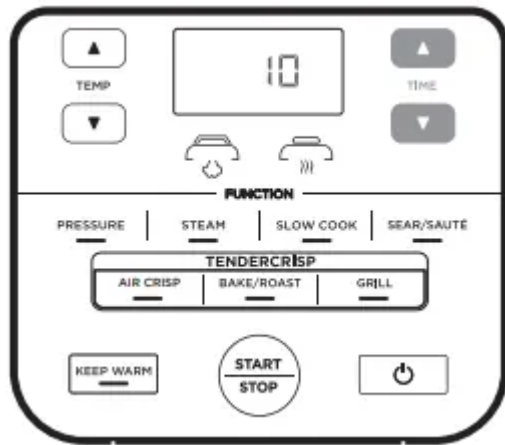

5. Press the START/STOP button. The display will show rotating lights during this time. When the unit reaches the proper temperature, the time you set will begin counting down.

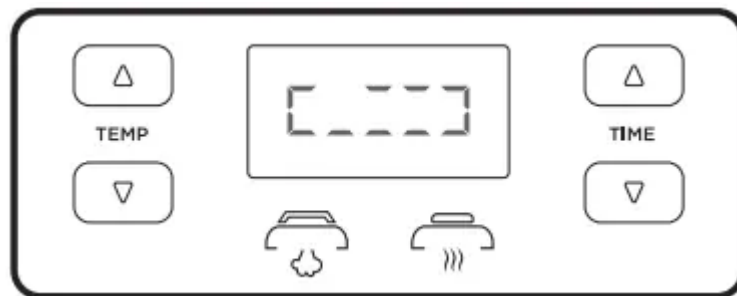

6. When cooking is complete, the unit will beep, automatically switch to Keep Warm mode, and start counting up from 00:00.



NOTE: After Pressure Cooking is complete, you may press the KEEP WARM button to turn the Keep Warm mode off.

7. Let the unit naturally release pressure or, if the recipe instructs, turn the pressure release valve to the VENT position, quickly releasing steam through the valve.

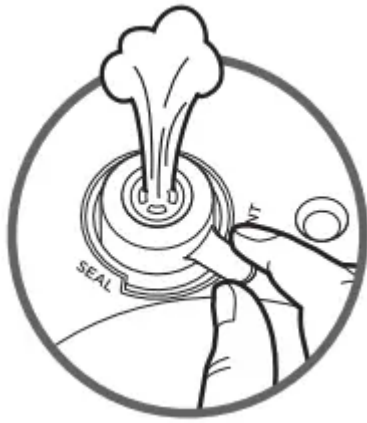

Steam

1. Add 240ml of liquid (or amount of liquid the recipe specifies) to the pot, then place the reversible rack or Cook & Crisp™ Basket with ingredients in the pot.

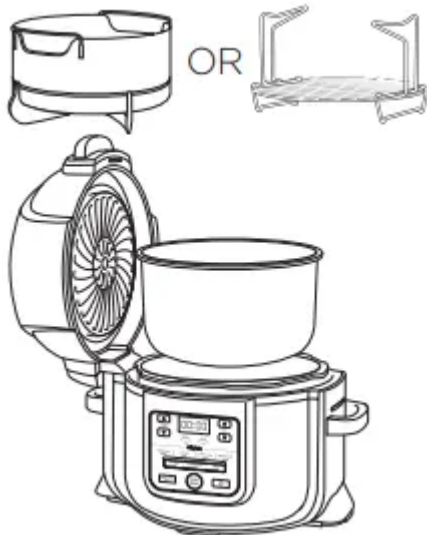

2. Follow the steps above to install the pressure lid on page 16. Turn the pressure release valve to the VENT position.



3. Press the STEAM button. Use the up and down TIME arrows to set the cook time in minute increments up to 30 minutes.

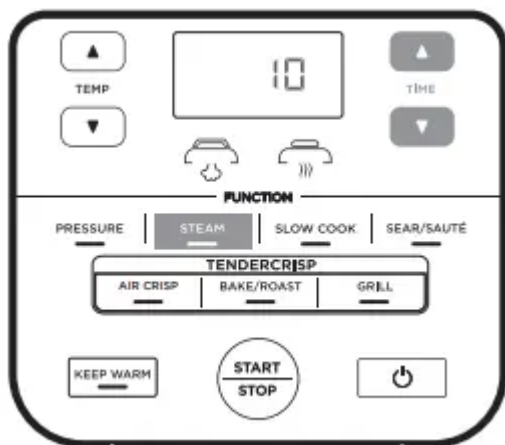

NOTE: There is no temperature adjustment available or necessary when using the Steam function.

4. Press the START/STOP button.
5. The unit will automatically preheat to bring the steaming liquid to a boil. The display will show rotating lights during this time. When the unit reaches the proper temperature, the time you set will begin counting down.

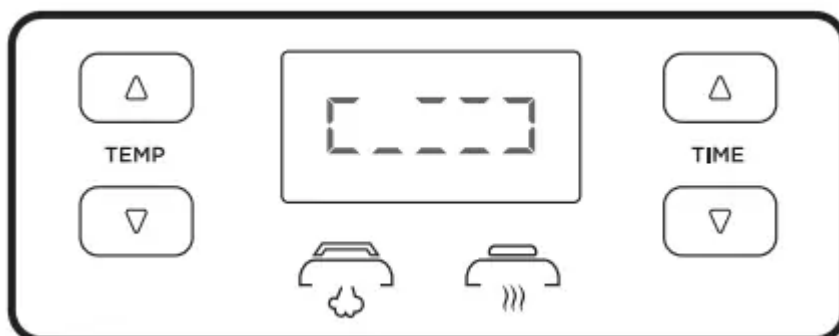

6. When cook time is complete, the unit will beep and automatically switch to Keep Warm mode. If the float valve pops up, wait for it to drop and then you can open the lid.



NOTE: After Steam cooking is complete, you may press the KEEP WARM button to turn the Keep Warm mode off.

Slow Cook

1. Add ingredients to the pot. DO NOT exceed the line marked MAX when slow cooking.
2. Follow the steps above to install pressure lid. Turn the pressure release valve to the VENT position.



3. Press the SLOW COOK button. The default temperature setting will display. Use the up and down TEMP arrows to select either Slow Cook HIGH or LOW.

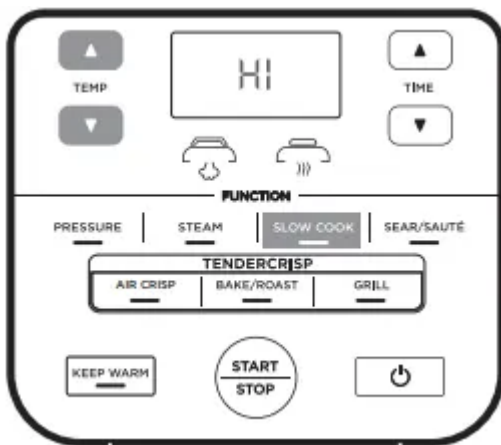

4. Use the up and down TIME arrows to set the cook time in 15-minute increments up to 12 hours.



5. Press the START/STOP button to begin cooking.

NOTE: The Slow Cook HIGH time setting may be adjusted anywhere between 4 and 12 hours; the Slow Cook LOW time setting may be adjusted anywhere between 6 and 12 hours.

6. When cook time is complete, the unit will beep and automatically switch to Keep Warm mode.

Sear/Sauté

1. Insert the pot.



2. Press the SEAR/SAUTÉ button. The default temperature setting will display. Use the up and down TEMP arrows to select one of the setting options (low, medium-low, medium, medium-high, or high).



NOTE: There is no time adjustment available or necessary when using the Sear/Sauté function.

3. Press the START/STOP button to begin cooking.

4. To turn off the Sear/Sauté function, press the START/STOP button. To switch to a different cooking function, press the corresponding function button.

NOTE: You can use this function with either the crisping lid in the open position or the pressure lid with the pressure release valve in the VENT position.

NOTE: ALWAYS use nonstick utensils in the cooking pot. DO NOT use metal utensils, as they will scratch the nonstick coating on the pot.

CLEANING & MAINTENANCE

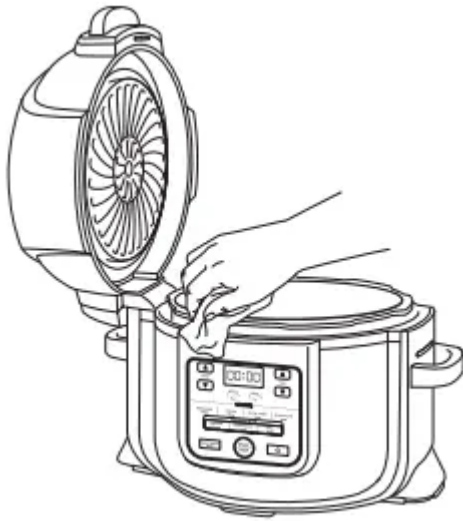

Cleaning: Dishwasher & Hand-Washing

The unit should be cleaned thoroughly after every use.

1. Unplug the unit from the socket before cleaning.
2. NEVER put the cooker base in the dishwasher, or immerse it in water or any other liquid.
3. To clean the cooker base and the control panel, wipe with a clean damp cloth.
4. The pressure lid, cooking pot, Silicone ring, reversible rack, Cook & Crisp™ Basket and detachable diffuser can be washed in the dishwasher.
5. The pressure release valve and anti-clog cap, can be washed with water and dish soap. DO NOT take apart the pressure release valve or float valve assembly.
6. To clean the crisping lid, wipe it down with a wet cloth or paper towel after the heat shield cools.
7. If food residue is stuck on the cooking pot, reversible rack, or Cook & Crisp™ Basket, fill the pot with water and allow to soak before cleaning. DO NOT use scouring pads. If scrubbing is necessary, use a non-abrasive cleanser or liquid dish soap with a nylon pad or brush.
8. Air-dry all parts after each use, or use a soft dry towel.

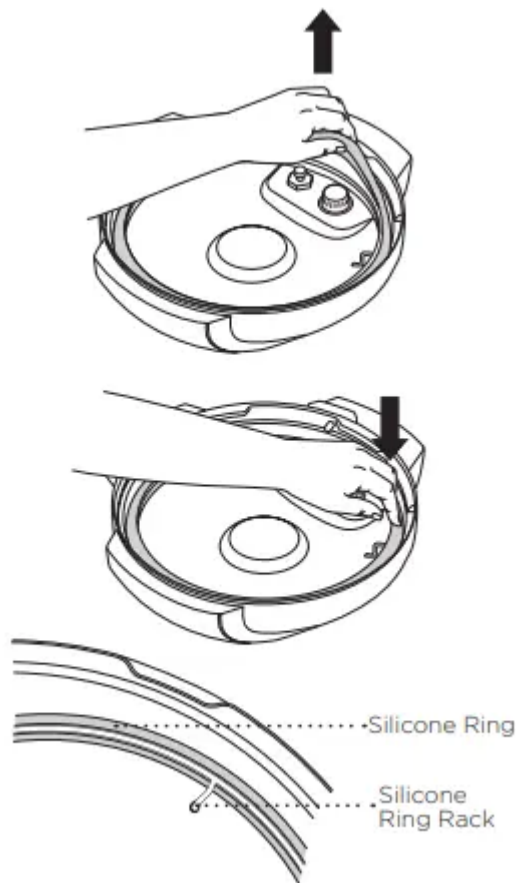

Removing & Reinstalling the Silicone Ring

To remove the Silicone ring, pull it outward, section by section, from the Silicone ring rack. The ring can be installed with either side facing up. To reinstall, press it down into the rack section by section.

After use, remove any food debris from the Silicone ring and anti-clog cap.

Keep the Silicone ring clean to avoid odour. Washing it in warm, soapy water or in the dishwasher can remove odour. However, it is normal for it to absorb the smell of certain acidic foods. It is recommended to have more than one Silicone ring on hand. You can purchase additional Silicone Rings on ninjakitchen.co.uk.

NEVER pull out the Silicone ring with excessive force, as that may deform it and the rack and affect the pressuresealing function. A Silicone ring with cracks, cuts, or other damage should be replaced immediately.

ACCESSORIES FOR PURCHASE

We offer a suite of accessories custom made for your Ninja® Foodi® Tendercrisp® Multi-Cooker. Visit ninjakitchen.co.uk to expand your capabilities and take your cooking to the next level.

Cooking Pot



An extra pot so you can keep the Foodi fun going when your other pot is already full of delicious food.

Silicone Muffin Mould



Bake your favourite mini muffins, cupcakes or egg bites in this flexible mould.

Glass Lid



See into the pot during multiple cooking functions, then use to transport or store easily.

Multi-Purpose Pan



- Create casseroles, dips and sweet and savoury pies or bake a fluffy, moist cake with a golden top for dessert.
- Dimensions: D22cm x H6cm

Roasting Rack Insert

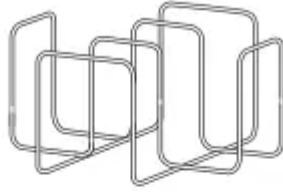

- Use this rack in the Cook & Crisp™ Basket to crisp up shells on Taco Tuesday, roast a rack of ribs on BBQ Sunday, or evenly toast garlic bread on pasta night.

Crisper Pan



- Crisp and reheat pizzas quesadillas and vegetables.
- Dimensions: D23cm x H2cm

Loaf Pan

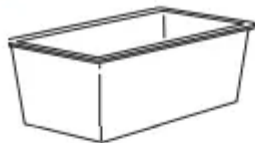

- Our specially designed pan is the perfectly sized baking accessory for bread mixes like banana and courgette.
- Dimensions:L21cm x W11cm x H9cm approx

Extra Pack of Silicone Rings



- 2-pack Silicone ring set helps keep flavours separate - use one when cooking savoury foods and the other cooking sweet foods.

TROUBLESHOOTING GUIDE

Why is my unit taking so long to come to pressure? How long does it take to come to pressure?

Cooking times may vary based on the selected temperature, current temperature of the cooking pot, and temperature or quantity of the ingredients.

Check to make sure your Silicone ring is fully seated and flush against the lid. If installed correctly, you should be able to tug lightly on the ring to rotate it.

Check that the pressure lid is fully locked, and the pressure release valve is in the SEAL position when pressure cooking.

Why is the time counting down so slowly?

You may have set hours rather than minutes. When setting time, the display will show HH:MM and the time will increase/decrease in minute increments.

How can I tell when the unit is pressurising?

The rotating lights will display on the screen to indicate the unit is building pressure.

Lights are rotating on the display screen when using the Pressure or Steam function.

This indicates the unit is building pressure or preheating when using STEAM or PRESSURE. When the unit has finished building pressure, your set cook time will begin counting down.

There is a lot of steam coming from my unit when using the Steam function.

It's normal for steam to release through the pressure release valve during cooking. Leave the pressure release valve in the VENT position for Steam, Slow Cook, and Sear/Sauté.

Why can't I take the pressure lid off?

As a safety feature, the pressure lid will not unlock until the unit is completely depressurised. Turn the pressure release valve to the VENT position to quick release the pressurised steam. A quick burst of steam will spurt out of the pressure release valve. When the steam is completely released, the unit will be ready to open. Turn the pressure lid anticlockwise, then lift it up and away from you.

Is the pressure release valve supposed to be loose?

Yes. The pressure release valve's loose fit is intentional; it enables a quick and easy transition between SEAL and VENT and helps regulate pressure by releasing small amounts of steam during cooking to ensure great results. Please make sure it is turned as far as possible toward the SEAL position when pressure cooking and as far as possible toward the VENT position when quick releasing.

The unit is hissing and not reaching pressure.

Make sure the pressure release valve is turned to the SEAL position. If you've done this and still hear a loud hissing noise, it may indicate your Silicone seal is not fully in place. Press START/STOP to stop cooking, VENT as necessary, and remove the pressure lid. Press down on the Silicone ring, ensuring it is fully inserted and lies flat under the ring rack. Once fully installed, you should be able to tug lightly on the ring to rotate it.

The unit is counting up rather than down.

The cooking cycle is complete and the unit is in Keep Warm mode.

How long does the unit take to depressurise?

Quick release is about 2 minutes or less. Natural release can take up to 20 minutes or more, depending on the type of food and/or the amount of liquid and food in the pot.

"POT" error message appears on display screen.

Cooking pot is not inside the cooker base. Cooking pot is required for all functions.

"LID" error message appears on display screen and lid icon flashes.

The incorrect lid is installed for your desired cooking function. Place the pressure lid on the unit if you want to use the Pressure, Slow Cook, Steam, Sear/Sauté, or Keep Warm functions and in the close position.

"SHUT" error message appears on display screen.

The crisping lid is open and needs to be closed for the selected function to start.

"VENT" error message appears on display screen.

When set to Slow Cook or Sear/Sauté, and the unit senses pressure building up, this message indicates the pressure release valve is in the SEAL position.

Turn the pressure release valve to the VENT position and leave it there for the remainder of the cooking function.

If you do not turn the pressure release valve to the VENT position within 5 minutes, the program will cancel and the unit will shut off.

"WATR" error message appears on display screen when using the Steam function.

The water level is too low. Add more water to the unit for the function to continue.

"WATR" error message appears on display screen when using the Pressure function.

Add more liquid to the cooking pot before restarting the pressure cook cycle.

Make sure the pressure release valve is in the SEAL position.

Make sure the Silicone ring is installed correctly.

"HOT" error message appears on display screen.

This indicates the unit has overheated. Let the unit cool down.

Once unit has cooled down, ensure there is no food caked on the bottom of the pot and there is enough liquid in the pot for the recipe you are preparing.

"ERR" message appears.

The unit is not functioning properly. Please contact Customer Service at 0800 862 0453.

HELPFUL TIPS

1. For consistent browning, make sure ingredients are arranged in an even layer on the bottom of the cooking pot with no overlapping. If ingredients are overlapping, make sure to shake half way through the set cook time.
2. For smaller ingredients that could fall through the reversible rack, we recommend first wrapping them in a parchment paper or foil pouch.
3. When switching from pressure cooking to using the crisping lid it is recommended to empty the pot of any remaining liquid for best crisping results.
4. Press and hold down the up or down Time arrows to move faster through Time display.
5. Use the Keep Warm mode to keep food at a warm, food-safe temperature after cooking. To prevent food from drying out, we recommend keeping the lid closed and using this function just before serving. To reheat food, use the Air Crisping function.
6. To have your unit build pressure quicker, set it to SEAR/SAUTÉ HIGH. Once ready to pressure cook, press the PRESSURE button and continue as you normally would.

REPLACEMENT PARTS

To order additional parts and accessories, visit ninjakitchen.co.uk or contact Customer Service at 0800 862 0453.

PRODUCT REGISTRATION

Please visit registeryourninja.com or call 0800 862 0453 to register your new Ninja® product within 28 days of purchase. You will be asked to provide the store name, date of purchase, and model number along with your name and address.

The registration will enable us to contact you in the unlikely event of a product safety notification.

NOTE: Save these instructions. Keep for future reference.

Warning

This content is compiled from multiple sources and is provided for reference purposes only. It may not be complete or fully applicable to all situations. If you are unable to resolve your issue, please contact the product manufacturer or an authorized service provider for official support.