

### NAME OF EACH PART

#### Indoor unit

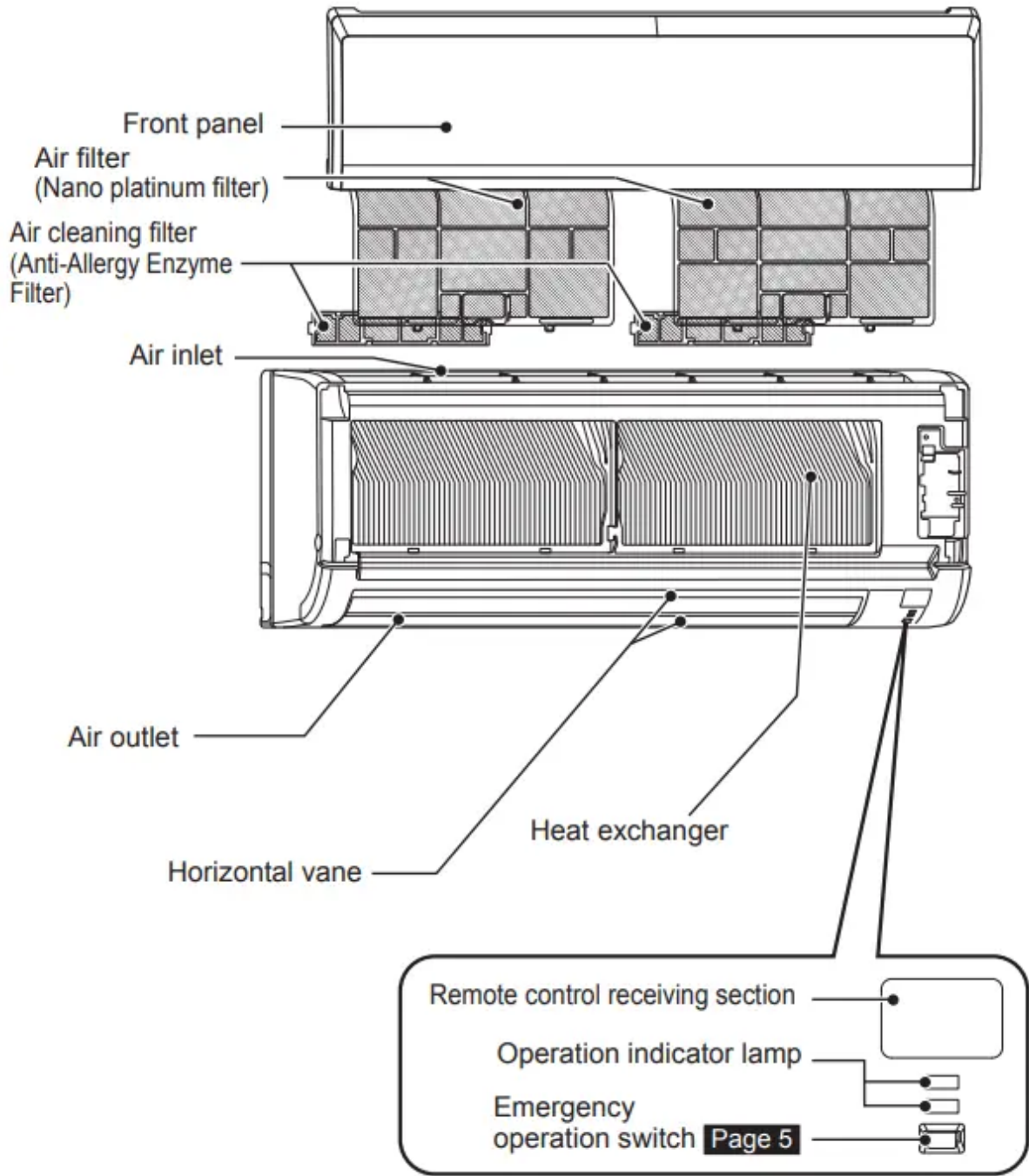

## Outdoor unit

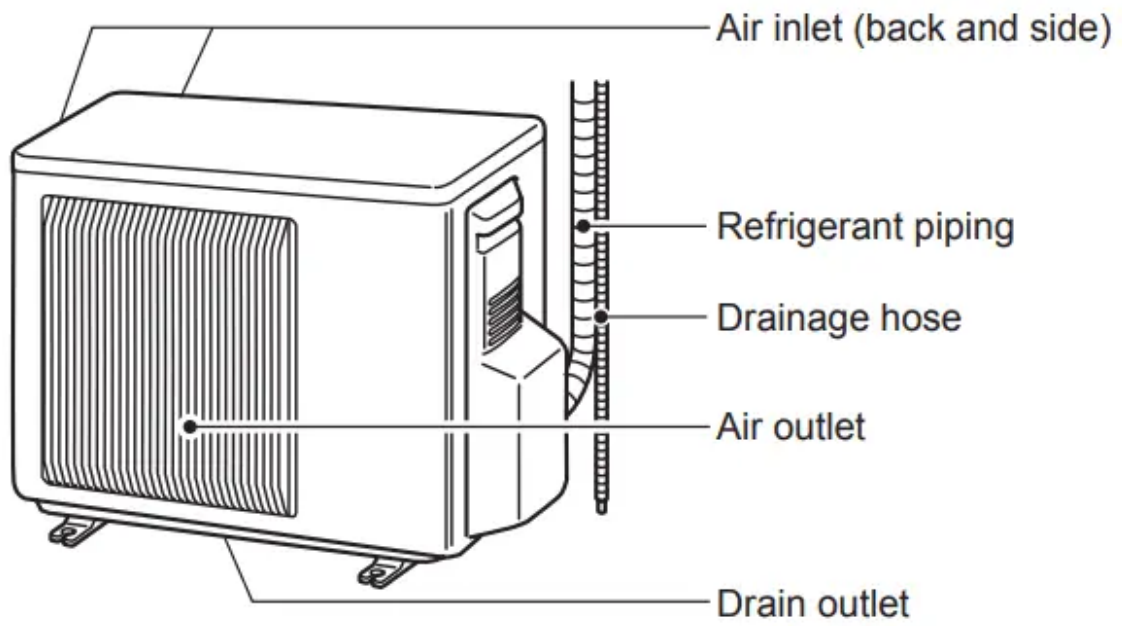

- Outdoor units may be different in appearance.

## Remote controller

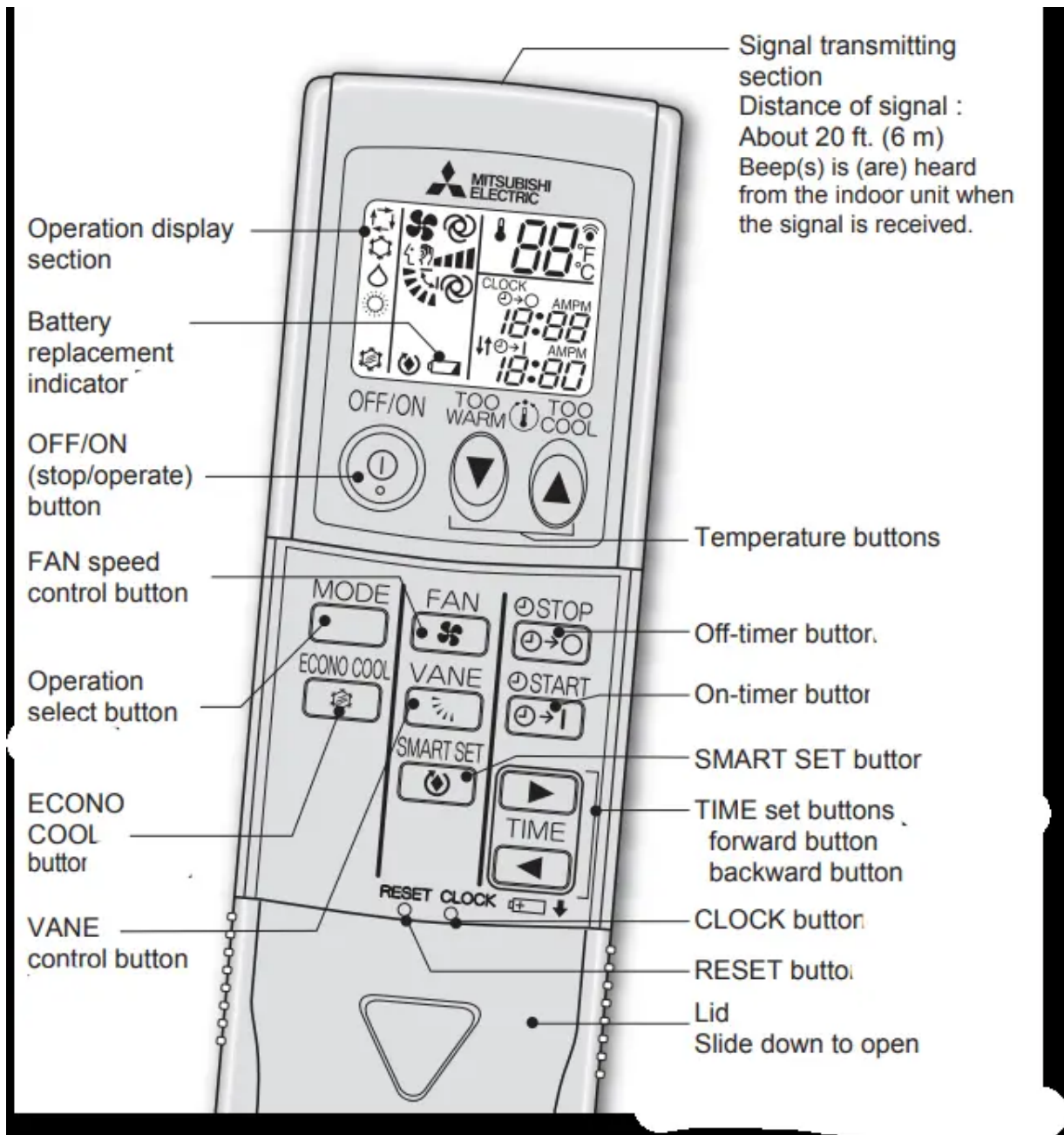

**Remote controller holder:** Install the remote controller holder in a place where the signal can be received by the indoor unit.

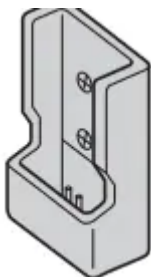

Only use the remote controller provided with the unit. Do not use other remote controllers. If two or more indoor units are installed in proximity to one another, an indoor unit that is not intended to be operated may respond to the remote controller.

## PREPARATION BEFORE OPERATION

### Installing the remote controller batteries

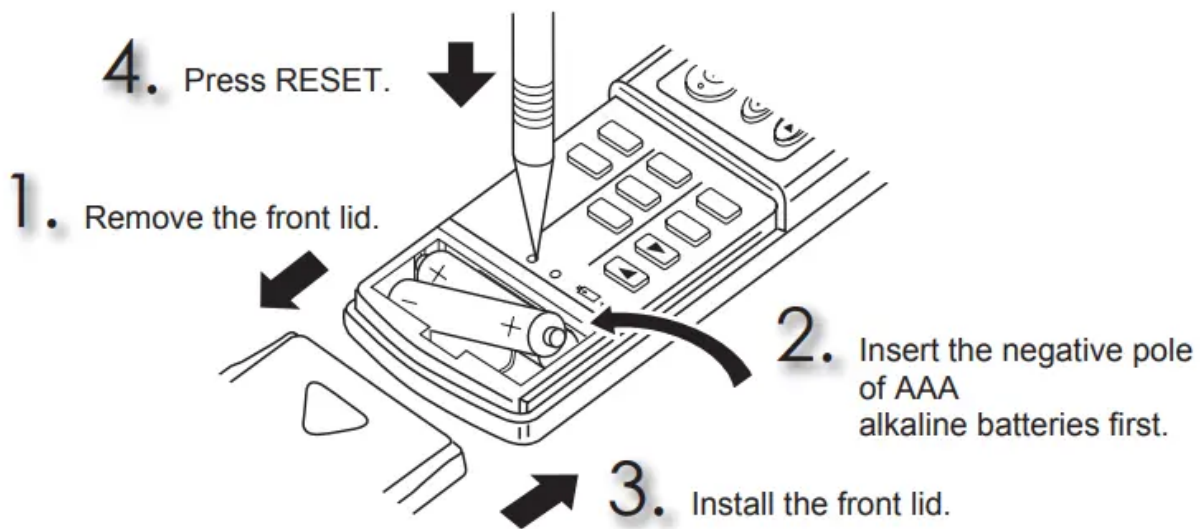

- Make sure the polarity of the batteries is correct.
- Do not use manganese batteries and leaking batteries. The remote controller could malfunction.
- Do not use rechargeable batteries.
- The battery replacement indicator lights up when the battery is running low. In about 7 days after the indicator starts lights up, the remote controller stops working.
- Replace all batteries with new ones of the same type.
- Batteries can be used for approximately 1 year. However, batteries with expired shelf lives last shorter. •
- Press RESET gently using a thin instrument. If the RESET button is not pressed, the remote controller may not operate correctly

## Setting current time

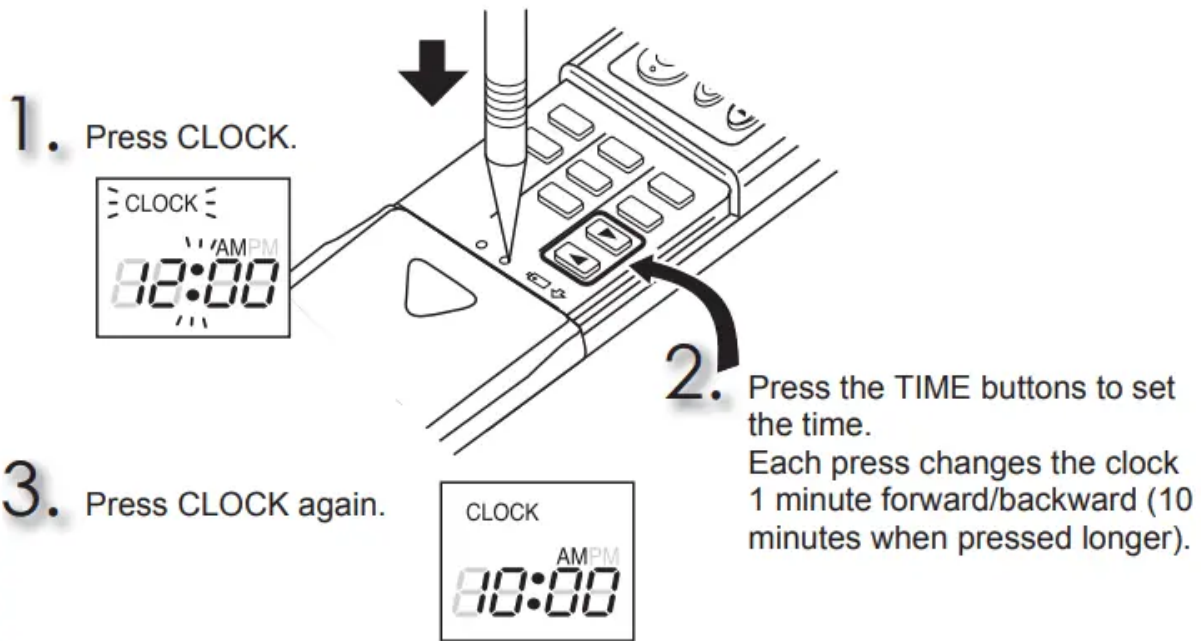

- Press CLOCK gently using a thin instrument.

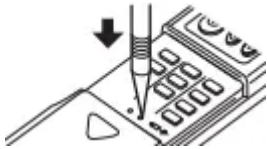

## Changing temperature units (°F → °C)

Unit is preset with °F.

Press RESET while the temperature buttons are pressed.

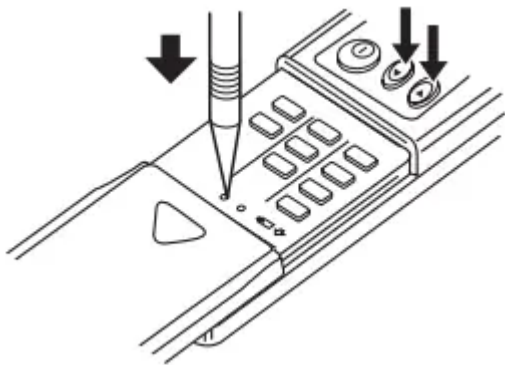

- Press RESET gently using a thin instrument.
- To change temperature unit from °C to °F, press RESET.

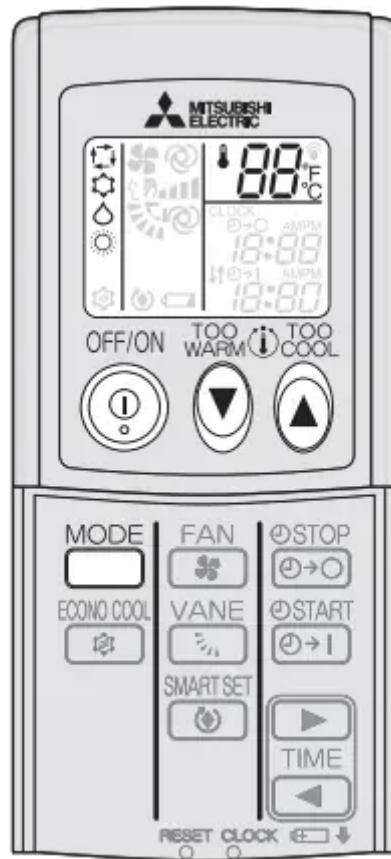

## SELECTING OPERATION MODES



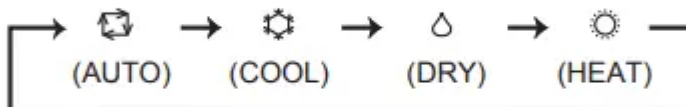

**1** Press  to start the operation.

**2** Press  to select operation mode. Each press changes mode in the following order:





**3** Press  or  to set the temperature. Each press raises or lowers the temperature by 1°F (1°C).

Press  to stop the operation.

- The same setting is selected the next time by simply pressing .

## Operation indicator lamp

The operation indicator lamp shows the operation state of the unit.

| Indication  | Operation state   | Room temperature                                  |
|---|---|---|
|  | The unit is operating to reach the set temperature      | About 4°F (2°C) or more away from set temperature |
|  | The room temperature is approaching the set temperature | About 2 to 4°F (1 to 2°C) from set temperature    |
|  | Standby mode (only during multi system operation)       | —   |

 Lighted    
  Blinking    
  Not lighted

**Multi system operation** Two or more indoor units can be operated by one outdoor unit. When several indoor units are operated simultaneously, cooling and heating operations cannot be done at the same time. When COOL is selected with one unit and HEAT with another or vice versa, the unit selected last goes into standby mode.



### AUTO mode (Auto change over)

The unit selects the operation mode according to the difference between the room temperature and the set temperature. During AUTO mode, the unit changes mode (COOL ↔ HEAT) when the room temperature is 4°F (2°C) away from the set temperature for more than 15 minutes.

**Note:** Auto Mode is not recommended if this indoor unit is connected to a MXZ type outdoor unit. When several indoor units are operated simultaneously, the unit may not be able to switch operation mode between COOL and HEAT. In this case, the indoor unit becomes standby mode (Refer to table of Operation indicator lamp).



### COOL mode

Enjoy cool air at your desired temperature.

**Note:** Do not operate COOL mode at very low outside temperatures (less than 14°F [-10°C]). Water condensed in the unit may drip and wet or damage furniture, etc.



### DRY mode

Dehumidify your room. The room may be cooled slightly. Temperature cannot be set during DRY mode.

## HEAT mode

Enjoy warm air at your desired temperature.

## Emergency operation

### When the remote controller cannot be used...

Emergency operation can be activated by pressing the emergency operation switch (E.O.SW) on the indoor unit.

Each time the E.O.SW is pressed, the operation changes in the following order:

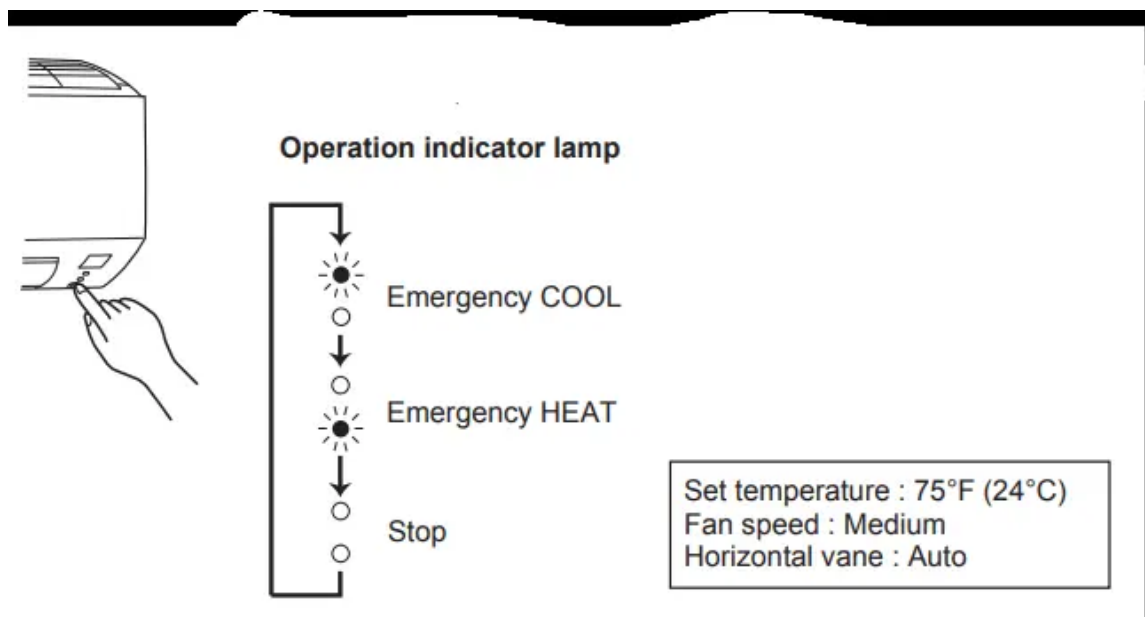

**Note:** The first 30 minutes of operation is test run. Temperature control does not work, and fan speed is set to High.

## Auto restart function

If a power failure occurs or the main power is turned off during operation, "Auto restart function" automatically starts operation in the same mode as the one set with the remote controller just before the shutoff of the main power. When timer is set, timer setting is cancelled and the unit starts operation when power is resumed.

If you do not want to use this function, please consult the service representative because the setting of the unit needs to be changed.

## FAN SPEED AND AIRFLOW DIRECTION ADJUSTMENT

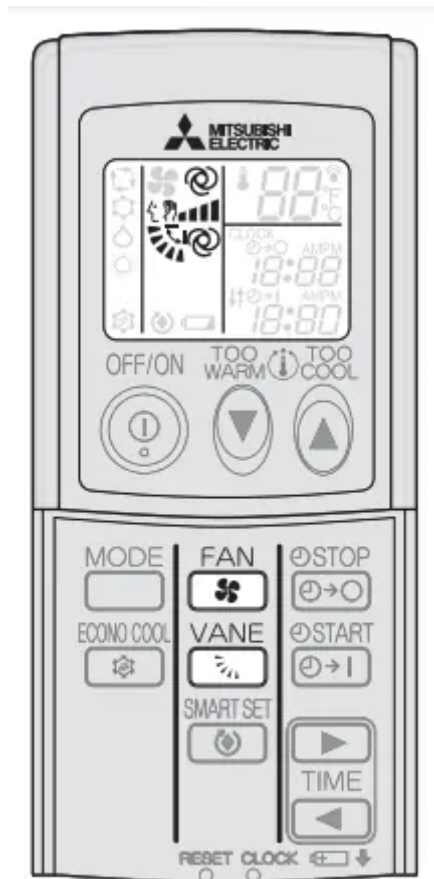

Press  to select fan speed. Each press changes fan speed in the following order:

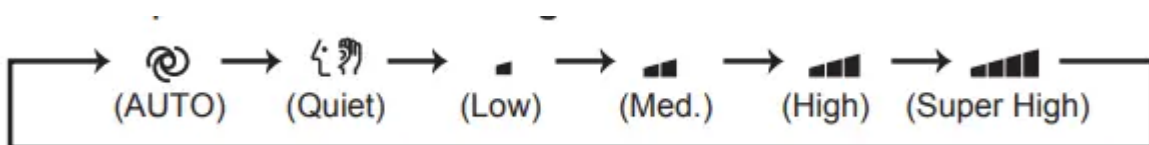

- Two short beeps are heard from the indoor unit when set to AUTO.
- Use higher fan speed to cool/heat the room quicker. It is recommended to lower the fan speed once the room is cool/warm.
- Use lower fan speed for quiet operation

Press  to select airflow direction. Each press changes airflow direction in the following order:

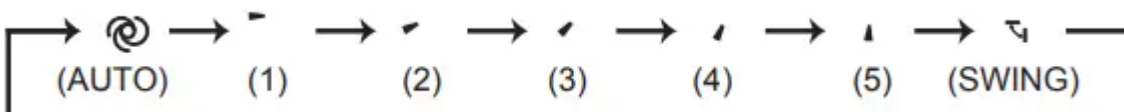

- Two short beeps are heard from the indoor unit when set to AUTO.

## Airflow direction

 (AUTO).....The vane is set to the most efficient airflow direction. COOL/ DRY:horizontal position. HEAT:position (5).

 (Manual).....For efficient air conditioning, select the upper position for COOL/ DRY, and the lower position for HEAT. If the position (4) or (5) is selected during COOL/DRY, the vane automatically moves to the upward position after 0.5 to 1 hour to prevent any condensation from dripping.

 (Swing).....The vane moves up and down intermittently.

**To change the horizontal airflow direction.** Move the vertical vane manually before starting operation.

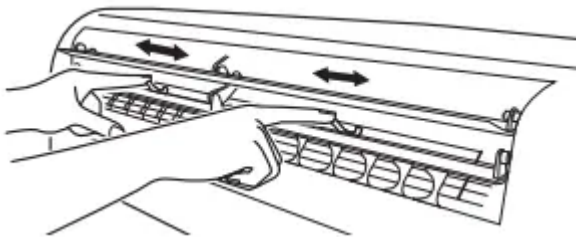

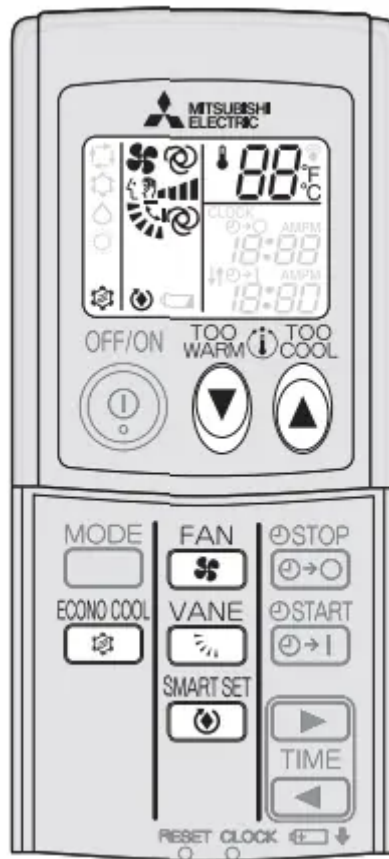

## SMART SET OPERATION



1. Press  during COOL, ECONO COOL, or HEAT mode to select SMART SET mode.

2. Set the temperature, fan speed, and airflow direction.

- The same setting is selected from the next time by simply pressing .
- Two settings can be saved. (One for COOL/ECONO COOL, one for HEAT)
- Select the appropriate temperature, fan speed, and airflow direction according to your room.
- Normally, the minimum temperature setting in HEAT mode is 59°F (16°C). However, during SMART SET operation only, the minimum temperature setting is 50°F (10°C).

Press  again to cancel SMART SET operation.

- SMART SET operation also is cancelled when the MODE button is pressed.

## SMART SET operation

A simplified set back function enables to recall the preferred (preset) setting with a single

push of the button. Press the  button again and you can go back to the previous setting in an instance

### Example of use:

1. Low energy mode - Set the temperature 4°F (2°C) to 6°F (3°C) warmer in COOL and cooler in HEAT mode. This setting is suitable for unoccupied room, and while you are sleeping.
2. Saving frequently used settings - Save your preferred setting for COOL/ECONO COOL and HEAT. This enables you to select your preferred setting with a single push of the button.

## TIMER OPERATION (ON/OFF TIMER)



1. Press  or  during operation to set the timer.



(ON timer) : The unit turns ON at the set time.



(OFF timer) : The unit turns OFF at the set time.

2. Press  (forward) and  (backward) to set the time of timer. Each press changes the set time 10 minutes forward/backward.

- Set the timer while or is blinking.

3. Press  or  again to cancel timer.

## CLEANING

### Air filter (Nano platinum filter)

Clean every 2 weeks

- Remove dirt by a vacuum cleaner, or rinse with water.
- After washing with water, dry it well in shade.

**What is “Nano platinum filter”?**

Nano platinum is a ceramic particle that includes a platinum nanoparticle. The particles are incorporated into the filter material, which results in providing semipermanent antibacterial and deodorizing characteristics for the filter. Nano platinum surpasses the catechin (a bioflavonoid that is found in green tea) in performance. Nano platinum filter uses this compound not only to improve air quality but also to eliminate bacteria and viruses. This air filter has a semi-permanent lasting effect even after washing it with water.

## Air cleaning filter (Anti-Allergy Enzyme Filter)

### Back side of air filter

Every 3 months:

- Remove dirt by a vacuum cleaner.

When dirt cannot be removed by vacuum cleaning:

- Soak the filter and its frame in lukewarm water before rinsing it.
- After washing, dry it well in shade.

Every year:

- Replace it with a new air cleaning filter for best performance.
- Parts Number MAC-408FT-E

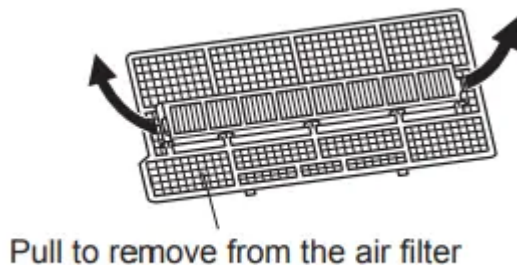

### Front panel

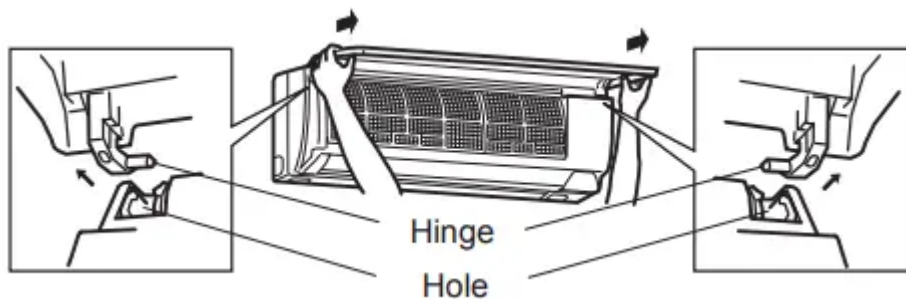

1. Lift the front panel until a “click” is heard.
2. Hold the hinges and pull to remove as shown in the illustration above.
  - Wipe with a soft dry cloth or rinse it with water.

- Do not soak it in water for more than two hours.
  - Dry it well in shade.
3. Install the front panel by following the removal procedure in reverse. Close the front panel securely and press the positions indicated by the arrows.

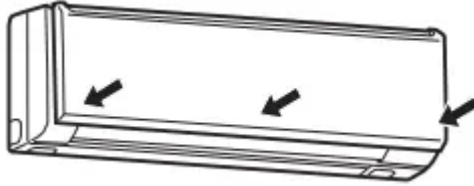



## TROUBLESHOOTING

**Even if these items are checked, when the unit does not recover from the trouble, stop using the air conditioner and consult your dealer.**

| Symptom   | Explanation & Check point  |
|---|--|
| <b>Indoor Unit</b>  |  |
| The unit cannot be operated.  | <ul style="list-style-type: none"> <li>• Is the breaker turned on?</li> <li>• Is the power supply plug connected?</li> <li>• Is the ON timer set?</li> </ul>   |
| The horizontal vane does not move.  | <ul style="list-style-type: none"> <li>• Are the horizontal vanes installed correctly?</li> <li>• Is the fan guard deformed?</li> </ul>  |
| The unit cannot be operated for about 3 minutes when restarted.   | <ul style="list-style-type: none"> <li>• This protects the unit according to instructions from the microprocessor. Please wait.</li> </ul>   |
| Mist is discharged from the air outlet of the indoor unit.  | <ul style="list-style-type: none"> <li>• The cool air from the unit rapidly cools moisture in the air inside the room, and it turns into mist.</li> </ul>  |
| The swing operation of the HORIZONTAL VANE is suspended for a while, then restarted.  | <ul style="list-style-type: none"> <li>• This is for the swing operation of the HORIZONTAL VANE to be performed normally.</li> </ul>   |
| <p>The airflow direction changes during operation.</p> <p>The direction of the horizontal vane cannot be adjusted with the remote controller.</p> | <ul style="list-style-type: none"> <li>• When the unit is operated in COOL or DRY mode, if the operation continues with air blowing down for 0.5 to 1 hour, the direction of the airflow is automatically set to upward position to prevent water from condensing and dripping.</li> <li>• In the heating operation, if the airflow temperature is too low or when defrosting is being done, the horizontal vane is automatically set to horizontal position.</li> </ul> |
| The operation stops for about 10 minutes  | <ul style="list-style-type: none"> <li>• Outdoor unit is in defrost.</li> </ul>  |

|  |  |
|--|--|
| <p>in the heating operation.</p>   | <p>Since this is completed in max.10 minutes, please wait. (When the outside temperature is too low and humidity is too high, frost is formed.)</p>  |
| <p>The unit starts operation by itself when the main power is turned on, but hasn't received sign from the remote controller.</p>          | <ul style="list-style-type: none"> <li>• These models are equipped with an auto restart function. When the main power is turned off without stopping the unit with the remote controller and is turned on again, the unit starts operation automatically in the same mode as the one set with the remote controller just before the shutoff of the main power. Refer to "Auto restart function"           .</li> </ul> |
| <p>The indoor unit discolors over time.</p>  | <ul style="list-style-type: none"> <li>• Although plastic turns yellow due to the influence of some factors such as ultraviolet light and temperature, this has no effect on the product functions.</li> </ul>   |
| <p><b>Multi system</b></p>   |  |
| <p>The indoor unit which is not operating becomes warm and a sound, similar to water flowing, is heard from the unit.</p>                  | <ul style="list-style-type: none"> <li>• A small amount of refrigerant continues to flow into the indoor unit even though it is not operating.</li> </ul>  |
| <p>When heating operation is selected, operation does not start right away.</p>  | <ul style="list-style-type: none"> <li>• When operation is started during defrosting of outdoor unit is done, it takes a few minutes (max. 10 minutes) to blow out warm air.</li> </ul>  |
| <p><b>Outdoor Unit</b></p>   |  |
| <p>The fan of the outdoor unit does not rotate even though the compressor is running. Even if the fan starts to rotate, it stops soon.</p> | <ul style="list-style-type: none"> <li>• When the outside temperature is low during cooling operation, the fan operates intermittently to maintain sufficient cooling capacity.</li> </ul>   |



|  |  |
|--|--|
| <p>Water leaks from the outdoor unit.</p>  | <ul style="list-style-type: none"> <li>• During COOL and DRY operations, pipe or pipe connecting sections are cooled and this causes water to condense.</li> <li>• In the heating operation, water condensed on the heat exchanger drips down.</li> <li>• In the heating operation, the defrosting operation makes ice forming on the outdoor unit melt and drip down.</li> </ul>  |
| <p>White smoke is discharged from the outdoor unit.</p>  | <ul style="list-style-type: none"> <li>• In the heating operation, vapor generated by the defrosting operation looks like white smoke.</li> </ul>  |
| <p><b>Remote controller</b></p>  |  |
| <p>The display on the remote controller does not appear or it is dim. The indoor unit does not respond to the remote control signal.</p> | <ul style="list-style-type: none"> <li>• Are the batteries exhausted? </li> <li>• Is the polarity (+, -) of the batteries correct?</li> <li>• Are any buttons on the remote controller or other electric appliances being pressed?</li> </ul>   |
| <p><b>Does not cool or heat</b></p>  |  |
| <p>The room cannot be cooled or heated sufficiently.</p>   | <ul style="list-style-type: none"> <li>• Is the temperature setting appropriate?</li> <li>• Is the fan setting appropriate? Please change fan speed to High or Super High. </li> <li>• Are the filters clean?</li> <li>• Is the fan or heat exchanger of the indoor unit clean?</li> <li>• Are there any obstacles blocking the air inlet or outlet of the indoor or outdoor unit?</li> <li>• Is a window or door open?</li> <li>• It may take a certain time to reach the setting temperature or may not reach that depending on the size of the room, the ambient temperature, and the like.</li> </ul> |



|   |   |
|---|---|
| <p>The room cannot be cooled sufficiently.</p>              | <ul style="list-style-type: none"> <li>• When a ventilation fan or a gas cooker is used in a room, the cooling load increases, resulting in an insufficient cooling effect.</li> <li>• When the outside temperature is high, the cooling effect may not be sufficient.</li> </ul>   |
| <p>The room cannot be heated sufficiently.</p>              | <ul style="list-style-type: none"> <li>• When the outside temperature is low, the heating effect may not be sufficient.</li> </ul>  |
| <p>Air does not blow out soon in the heating operation.</p> | <ul style="list-style-type: none"> <li>• Please wait as the unit is preparing to blow out warm air.</li> </ul>  |
| <p><b>  Airflow</b></p>                                     |   |
| <p>The air from the indoor unit smells strange.</p>         | <ul style="list-style-type: none"> <li>• Are the filters clean?</li> <li>• Is the fan or heat exchanger of the indoor unit clean?</li> <li>• The unit may suck in an odor adhering to the wall, carpet, furniture, cloth, etc. and blow it out with the air.</li> </ul>   |
| <p><b>Sound</b></p>   |   |
| <p>Cracking sound is heard.</p>                             | <ul style="list-style-type: none"> <li>• This sound is generated by the expansion/con-traction of the front panel, etc. due to change in temperature.</li> </ul>  |
| <p>“Bubbling” sound is heard.</p>                           | <ul style="list-style-type: none"> <li>• This sound is heard when the outside air is absorbed from the drain hose by turning on the range hood or the ventilation fan, making water flowing in the drain hose to spout out.</li> </ul> <p>This sound is also heard when the outside air blows into the drain hose in case the outside wind is strong.</p> |
| <p>Mechanical sound is heard from the indoor unit.</p>      | <ul style="list-style-type: none"> <li>• This is the switching sound in turning on/off the fan or the compressor.</li> </ul>  |



|                                      |  |
|--------------------------------------|--|
| The sound of water flowing is heard. | <ul style="list-style-type: none"><li>• This is the sound of refrigerant or condensed water flowing in the unit.</li></ul>   |
| Hissing sound is sometimes heard.    | <ul style="list-style-type: none"><li>• This is the sound when the flow of refrigerant inside the unit is changed.</li></ul> |

**In the following cases, stop using the air conditioner and consult your dealer.**

- When water leaks or drips from the indoor unit.
- When the upper operation indicator lamp blinks.
- When the breaker trips frequently.
- The remote control signal is not received in a room where an electronic ON/OFF type fluorescent lamp (inverter-type fluorescent lamp, etc.) is used.
- Operation of the air conditioner interferes with radio or TV reception. An amplifier may be required for the affected device.
- When an abnormal sound is heard.\When any refrigerant leakage is found.

**Warning**

This content is compiled from multiple sources and is provided for reference purposes only. It may not be complete or fully applicable to all situations. If you are unable to resolve your issue, please contact the product manufacturer or an authorized service provider for official support.