

## Installation

Follow these instructions carefully to ensure proper installation of the washing machine and to prevent accidents when doing laundry.

### What's included

Make sure all the parts are included in the product package. If you have a problem with the washing machine or the parts, contact a local Samsung customer centre or the retailer.

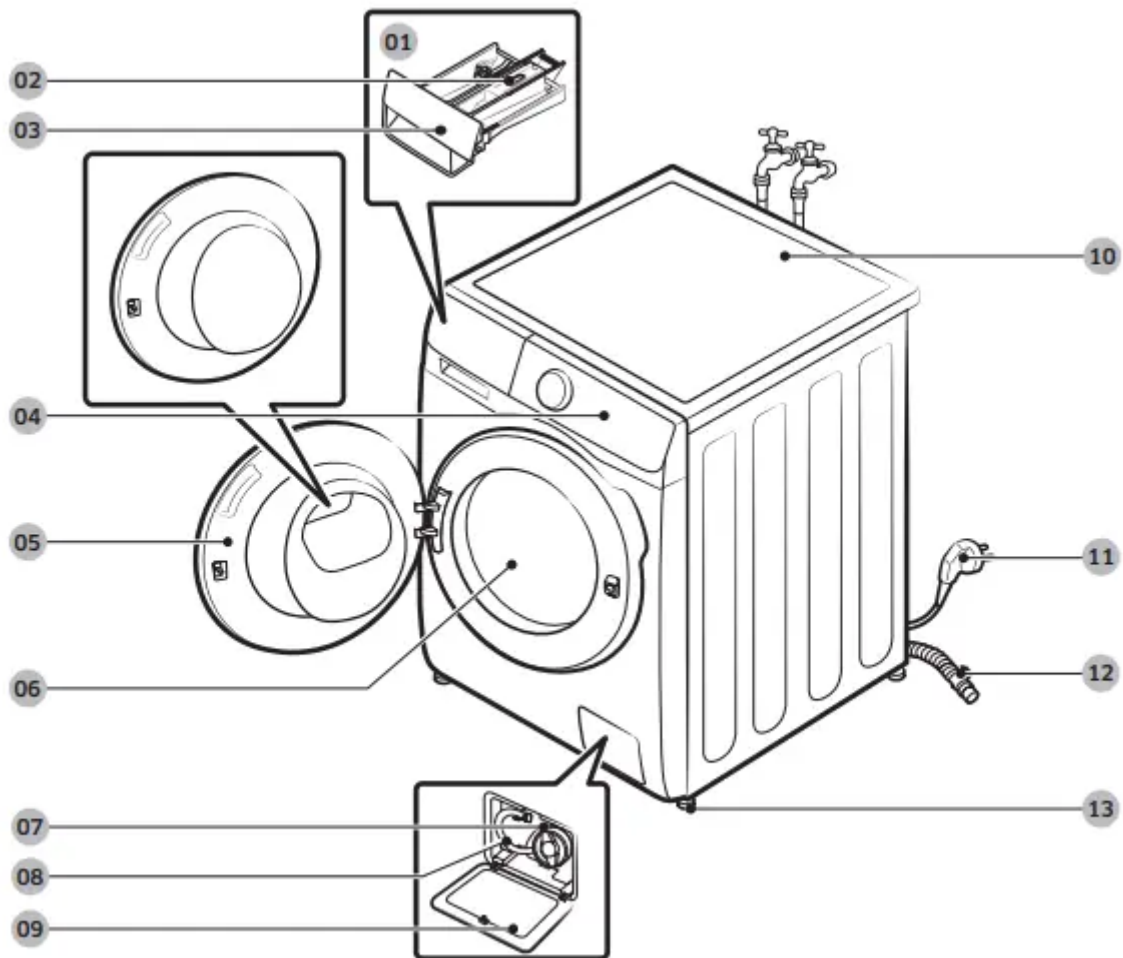

01 Manual dispenser

02 Release lever

03 Detergent drawer

04 Control panel

05 Door

06 Drum

- 07 Debris filter
- 08 Emergency drain tube
- 09 Filter cover
- 10 Worktop
- 11 Power plug
- 12 Drain hose
- 13 Levelling feet

\* The design of the drawer and/or the lever differs with the model

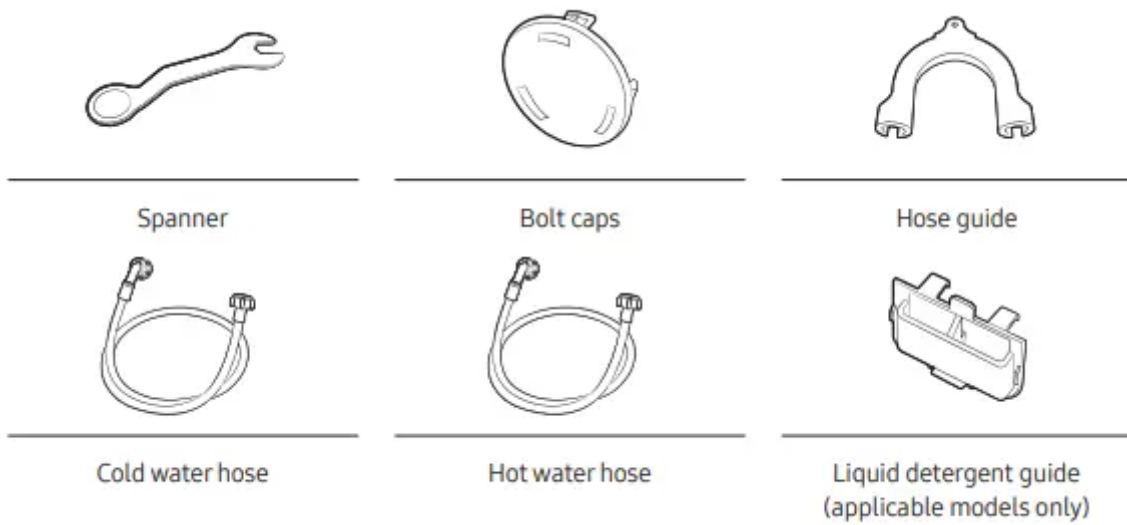

### **Accessories (not supplied)**

#### **• Stacking kit**

<ul style="list-style-type: none"> <li>• WW**T5*****, WW7*T*****, WW8*T6*****, WW8*T7*****, WW9*T6*****, WW9*T7***** Models only</li> </ul>
<ul style="list-style-type: none"> <li>• WW1*T*****, WW8GT6*****, WW8*T6*6***, WW8*T7*6***, WW**T8*****, WW**T9*****, WW9*T6*6*** Models only</li> </ul>
<ul style="list-style-type: none"> <li>• WW12T***** Models only</li> </ul>

Stacking kit is required to stack a dryer on a washing machine.

#### **NOTE**

- Spanner: For removing the shipping bolts and levelling the washing machine.
- Bolt caps: For covering the holes after removing the shipping bolts. The provided number of bolt caps (3 to 6) depends on the model.

- Hose guide: For hanging the drain hose in the drainpipe or wash-basin.
- Cold/Hot water hose: For supplying water to the washing machine. (Hot water hoses is for applicable models only.)
- Liquid detergent guide: Insert it in the detergent compartment to use liquid detergent.

## **Installation requirements**

### **Electrical supply and grounding**

- Use an individual branch circuit specific to the washing machine.
- Do not remove or modify the grounding pin of power cord to reduce the risk of electric hazard.
- Please use the additional grounding wire provided with this appliance if there is no hole for earth pin in power inlet socket.

To ensure proper grounding, the washing machine comes with a power cord featuring a three-prong grounding plug for use in a properly installed and grounded outlet.

Check with a qualified electrician or service person if you are not sure about the grounding.

Do not modify the provided plug. If it does not fit the outlet, call a qualified electrician to install a suitable outlet.

### **WARNING**

- Do NOT use an extension cord.
- Use only the power cord that comes with the washing machine.
- Do NOT connect the ground wire to plastic plumbing, gas lines, or hot water pipes.
- Improperly connected grounding conductors may cause electric shock.

### **Water supply**

A proper water pressure for this washing machine is between 50 kPa and 800 kPa. Water pressure less than 50 kPa may cause the water valve to not close completely, or it may take longer to fill the drum, causing the washing machine to turn off.

Water taps must be within 120 cm from the rear of the washing machine so that the provided inlet hoses reach the washing machine.

To reduce the risk of leaks:

- Make sure water taps are easily accessible.
- Turn off the taps when the washing machine is not in use.
- Check for any leaks at the water inlet hose fittings on a regular basis.

### **CAUTION**

Before using the washing machine for the first time, check all connections at the water valve and taps for any leaks.

### **Drain**

Samsung recommends a standpipe 60-90 cm high. The drain hose must be connected through the hose clip to the standpipe, and the standpipe must fully cover the drain hose.

### **Flooring**

For best performance, the washing machine must be installed on a solid floor. Wood floors may need to be reinforced to minimise vibration and/or unbalanced loads. Carpeting and soft tile surfaces do not resist vibration well and may cause the washing machine to move slightly during the spin cycle.

### **CAUTION**

Do NOT install the washing machine on a platform or a poorly supported structure.

### **Water temperature**

Do not install the washing machine in areas where water may freeze as the washing machine always retains some water in its water valves, pumps, and/or hoses. Frozen water left in the connection parts may cause damage to belts, the pump, and other components of the washing machine.

## **Step-by-step installation**

### **STEP 1 Select a location**

Location requirements:

- Solid, level surface without carpeting or flooring that may obstruct ventilation
- Away from direct sunlight
- Adequate room for ventilation and wiring
- The ambient temperature is always higher than the freezing point (0 °C)
- Away from a heat source

### **STEP 2 Remove the shipping bolts**

Unpack the product package and remove all shipping bolts.

### **NOTE**

Number of shipping bolts may differ depending on the model.

### **WARNING**

- Packaging materials can be dangerous to children. Dispose all packaging material (plastic bags, polystyrene, etc.) out of children's reach.

- To avoid injury, cover the holes with bolt caps after removing the shipping bolts. Do not move the washing machine without the shipping bolts in place. Assemble the shipping bolts before moving the washing machine to another location. Keep the shipping bolts in a safe place for future use.

1. Locate the shipping bolts (marked with circle in the figure) on the rear side of the washing machine.

### **CAUTION**

Do not remove the screw (A) that fixes the hose clip.

2. Using the supplied spanner, loosen all the shipping bolts by turning them counterclockwise.

### **NOTE**

You must keep the shipping bolts for future use.

3. Insert the bolt caps (B) to the holes (marked with circle in the figure)

### **STEP 3 Adjust the levelling feet**

1. Gently slide the washing machine into position.

Excessive force may damage the levelling feet.

2. Level the washing machine by manually adjusting the levelling feet.

3. When levelling is complete, tighten the nuts using the spanner.

### **CAUTION**

When installing the product make sure the levelling feet is not pressing the power cord.

### **STEP 4 Connect the water hose**

The provided water hose may differ depending on the model. Please follow the instruction according to the provided water hose.

#### **Connecting to a threaded water tap**

1. Connect the water hose to the water tap, and then turn it to the right to tighten.
2. Connect the other end of the water hose to the inlet valve on the back of the washing machine, and then turn it to the right to tighten.
3. Slowly open the water tap and check if there are any leaks around the connection areas. If there are water leaks, repeat step 1 and 2.

#### **Connecting to a non-threaded water tap**

1. Remove the adaptor (A) from the water hose (B).
2. Use a Phillips screwdriver to loosen four screws on the adaptor.

3. Hold the adaptor and turn part (C) in the arrow direction to loosen it by 5 mm (\*).
4. Insert the adaptor onto the water tap, and then tighten the screws while lifting the adaptor.
5. Turn part (C) in the arrow direction to tighten it.
6. While pulling down part (D) on the water hose, connect the water hose to the adaptor. Then, release part (D). The hose fits into the adaptor with a clicking sound.
7. To complete connecting the water hose, see 2 and 3 on the “Connecting to a threaded water tap” section.

#### **NOTE**

- After connecting the water hose to the adaptor, pull the water hose down to check if it is connected properly.
- Use a popular type of water taps. If the tap is square-shaped or too big, remove the spacer ring before inserting the tap into the adaptor.

#### **For models with an additional hot water inlet:**

1. Connect the red end of the hot water hose to the hot water inlet on the back of the machine.
2. Connect the other end of the hot water hose to the hot water tap.

#### **Aqua hose (applicable models only)**

The aqua hose alerts users of a risk of water leaks.

It senses the water flow and turns red on the centre indicator (A) in case of a leak.

#### **NOTE**

The end of the aqua stop hose must be fitted to the water tap and not the machine.

#### **STEP 5 Position the drain hose**

The drain hose can be positioned in three ways:

##### **Over the edge of a wash basin**

The drain hose must be placed at a height of between 60 cm and 90 cm (\*) from the floor. To keep the spout of the drain hose bent, use the supplied plastic hose guide (A). Secure the guide to the wall using a hook to ensure stable drainage.

##### **In a drain pipe**

The drain pipe should be between 60 cm and 90 cm high

(\*). It is advisable to use a 65 cm high vertical pipe.

- To ensure the drain hose stays in position, use the plastic hose guide provided (see the figure).

- To prevent the siphoning of water flow during drainage, make sure to insert the drain hose 15 cm in the drain pipe.
- To prevent the drain hose from moving around, secure the hose guide to the wall.

#### **Drain standpipe requirements:**

- Minimum diameter of 5 cm
- Minimum carry-away capacity of 60 litres per minute

#### **In a sink drain pipe branch**

The drain pipe branch must be above the sink siphone so that the end of the hose is at least 60 cm above the ground.

(\*) : 60 cm

#### **CAUTION**

Remove the lid on the sink drain pipe branch before connecting the drain pipe to it.

#### **STEP 6 Power on**

Plug the power cord into a wall socket that is correctly rated, grounded, and protected by a fuse or circuit breaker. Then, tap and hold  for 3 seconds to turn on the washing machine.

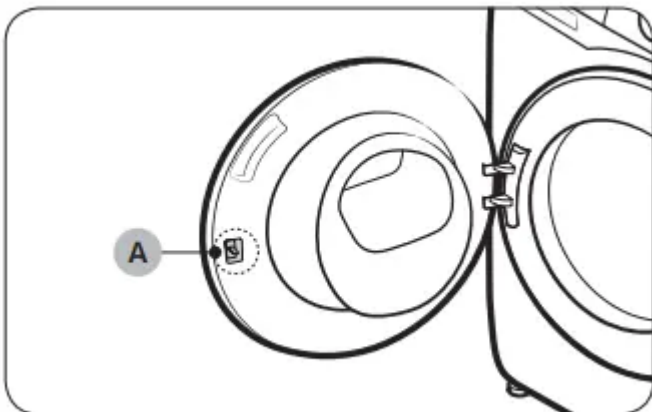









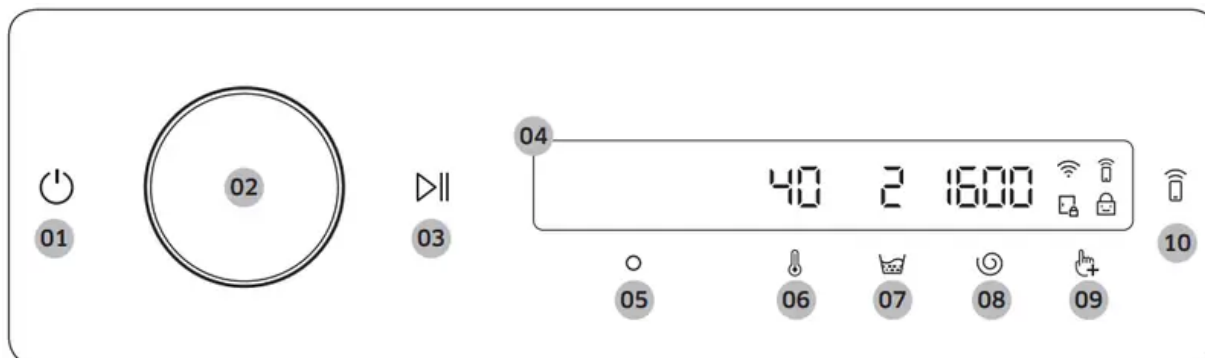



#### **NOTE**

Door latch (lever) (A) is originally designed to be loose a little, because it may makes the door latch be inserted into the door more easily





# Operations

## Control panel









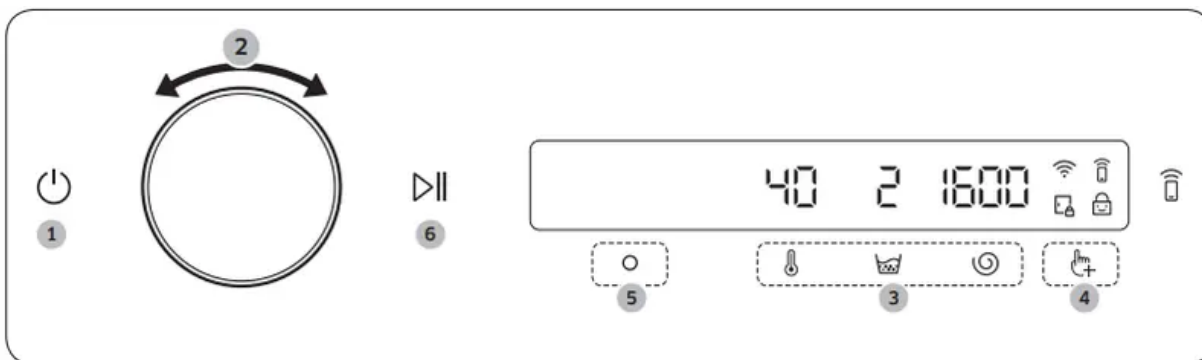

<b>01 Power</b> 	<p>Tap to turn the washing machine on or off.</p> <ul style="list-style-type: none"> <li>If you do not manipulate the control panel for 10 minutes after the washing machine is turned on, the washing machine automatically turns off.</li> <li>The washing machine automatically turns off when the cycle completes.</li> </ul> <p><b>⚠ CAUTION</b></p> <p>Do not tap  to turn the washing machine off while the wash cycle is in progress. Tap and hold  to pause the cycle first, and then tap  to turn the washing machine off.</p>
<b>02 Navigation dial</b>	<p>Turn the navigation dial left or right to navigate through cycles and functions. When you turn the navigation dial, LCD displays your selection (such as cycle, additional functions, and system functions).</p>
<b>03 Start/Pause</b> 	<p>Tap and hold to start or pause an operation.</p>
<b>04 Display</b>	<p>The display shows current cycle information and estimated time remaining, or an information message when a problem occurs.</p>
<b>05 OK</b> 	<p>Tap to confirm your selection of function or setting.</p>
<b>06 Temp.</b> 	<p>Tap to change the water temperature for the selected cycle.</p> <ul style="list-style-type: none"> <li>The indicator above the button indicates the default or selected setting.</li> </ul>
<b>07 Rinse</b> 	<p>Tap to change the rinse count for the selected cycle.</p> <ul style="list-style-type: none"> <li>The indicator above the button indicates the default or selected setting.</li> </ul>
<b>08 Spin</b> 	<p>Tap to change the spin speed for the selected cycle.</p> <ul style="list-style-type: none"> <li>The indicator above the button indicates the default or selected setting.</li> </ul>
<b>09 Additional function</b> 	<p>Tap to enter the additional functions menu. Tap and hold for 3 seconds to enter the system functions menu.</p>
<b>10 Smart Control</b> 	<p>Tap to activate or deactivate the Smart Control function. Tap and hold to enter pairing mode to connect to the SmartThings app.</p> <ul style="list-style-type: none"> <li>When the Smart Control function is activated, you can control your washing machine remotely using the SmartThings app on your smartphone or tablet (Android or iOS).</li> </ul>

## Icon descriptions

	Wi-Fi	<ul style="list-style-type: none"><li>This icon indicates that the washing machine is connected to Wi-Fi.</li></ul>
	Smart Control	<ul style="list-style-type: none"><li>This icon indicates that Smart Control is on.</li><li>For more information on Smart Control, see page 46.</li></ul>
	Door Lock	<ul style="list-style-type: none"><li>This icon indicates the door is locked and cannot be opened.</li><li>The door locks automatically during a cycle and this indicator turns on.</li><li>You can open the door when this icon disappears.</li></ul>
	Child Lock	<ul style="list-style-type: none"><li>This icon indicates that Child Lock is on.</li><li>For more information on Child Lock, see page 42.</li></ul>

## Operating a cycle





1. Tap  to turn on the washing machine.
2. Turn the Navigation dial to select the cycle you want.
  - For more information on Cycle overview, see page 37.
3. Tap , , or  to change the default cycle settings.
4. Tap , and then turn the Navigation dial to select additional function.
  - For more information on Additional functions, see page 40.
5. Tap  to change the settings for selected additional function.
  - Not all cycles have additional functions available.
6. Tap and hold  to start operation.
  - Once you set the cycle you want, the screen displays a brief cycle description, maximum laundry load, and cycle time. You can also check the cycle progress, remaining cycle time, and information codes.

## Maintenance

Keep the washing machine clean to prevent deteriorated performance and to preserve its life cycle.

## Drum clean

Perform this cycle regularly to clean the drum by removing bacteria from it. This cycle heats the water between 60 °C and 70 °C, and it also removes accumulated dirt from the rubber door gasket.

1. Tap .
2. Turn the Navigation dial to select Drum Clean+.
3. Tap and hold .

### CAUTION

- Do not use any cleaning agents for cleaning the drum. Chemical residue in the drum may cause damage to the laundry or the drum of the washing machine.
- To prevent limescale, add the proper amount of detergent according to your local water hardness or add a water softener additive together with the detergent.

### DRUM CLEAN+ reminder

Depending on the model, the DRUM CLEAN+ reminder is either an icon or an LED.

For icons, the icon lights up on the control panel.

For LEDs, the LED lights up next to DRUM CLEAN+, or on the option area of the control panel.

- The DRUM CLEAN+ reminder blinks on the control panel once every 40 washes. It is advisable to perform DRUM CLEAN+ regularly.
- When you first see this reminder blinking, you can ignore the reminder for 6 consecutive washes. From the 7th wash, the reminder no longer appears. However, it appears again on the second 40th wash.
- Even after the last process is terminated, the "0" message may remain.
- You can record the running count of the DRUM CLEAN+ cycle by pressing the Power button. This does not stop or turn off the machine but marks your cycle count.
- Even if "0" does not disappear, the machine operates normally.
- It is recommended to run the cycle regularly for hygienic purposes

## Emergency drain

In case of a power failure, drain the water inside the drum before taking out the laundry.

1. Power off and unplug the washing machine from the electrical outlet.
2. Gently press the top area of the filter cover to open.

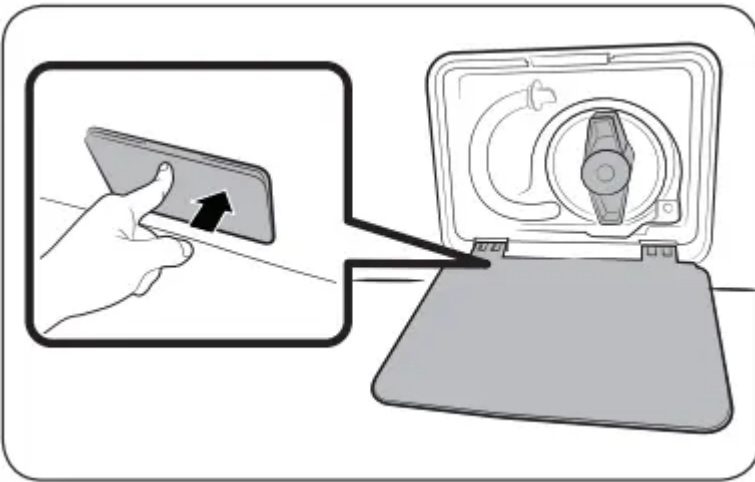

3. Put an empty, spacious container around the cover, and stretch the emergency drain tube to the container while holding the tube cap (A).

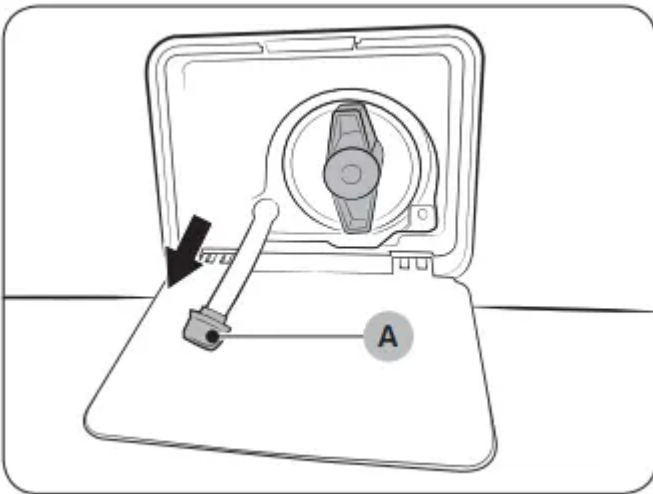

4. Open the tube cap and let water in the emergency drain tube (B) flow into the container.

5. When done, close the tube cap, and reinsert the tube. Then, close the filter cover.

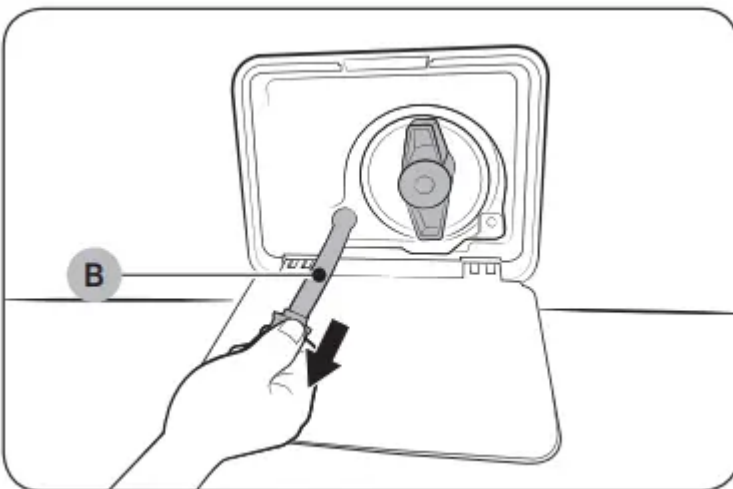

**NOTE**



Use a spacious container because the water in the drum may be more than expected.

## Cleaning

### Surface of the washing machine

Use a soft cloth with a nonabrasive household detergent. Do not spray water onto the washing machine.

### AddWash door (applicable models only)



1. Open the AddWash door.
2. Use a wet cloth to clean the AddWash door.
  - Do not use cleaning agents. Discolouration may occur.
  - Use caution when cleaning the rubber packing and the locking mechanism (A).
  - Dust off the door area regularly.
3. Wipe up and close the AddWash door until you hear a clicking sound.

### CAUTION

- Do not apply force on the AddWash door. It may break.
- Do not leave the AddWash door open while the machine is operating.
- Do not put heavy objects on the AddWash door at any time.
- To prevent physical injury, do not touch the AddWash door while the drum is rotating.
- Do not open the AddWash door while the machine is operating. This may cause physical injury.
- Do not manipulate the feature panel while the AddWash door is open. This may cause physical injury or system failure.
- Do not input objects other than laundry.
- Do not input bulky items to the drum through the AddWash door.

- Do not pull out the rubber packing of the AddWash door when cleaning. This may cause damage.

### **Mesh filter**

Clean the mesh filter of the water hose once or twice a year.

1. Turn off the washing machine, and unplug the power cord.
2. Close the water tap.
3. Loosen and disconnect the water hose from the back of the washing machine. Cover the hose with a cloth to prevent water from gushing out.
4. Use pliers to pull out the mesh filter from the inlet valve.
5. Submerge the mesh filter deeply in water so that the threaded connector is also submerged.
6. Dry the mesh filter completely in the shade.
7. Reinsert the mesh filter into the inlet valve, and reconnect the water hose to the inlet valve.
8. Open the water tap.

### **Debris filter**

It is advisable to clean the debris filter every 2 months to prevent its clogging. A clogged debris filter may reduce the bubble effect.

1. Turn off the washing machine, and unplug the power cord.
2. Drain the remaining water inside the drum. See the “Emergency drain” section.
3. Gently press the top area of the filter cover to open.
4. Turn the debris filter knob to the left, and drain off the remaining water.
5. Clean the debris filter using soft brushes. Make sure the drain pump propeller inside the filter is unclogged.
6. Reinsert the debris filter, and turn the filter knob to the right.

### **NOTE**

- Some debris filters feature a safety knob that is designed to prevent accidents by children. To open the safety knob of the debris filter, push in and turn it anticlockwise. The spring mechanism of the safety knob helps open the filter.
- To close the safety knob of the debris filter, turn it clockwise. The spring makes a rattling sound, which is normal.

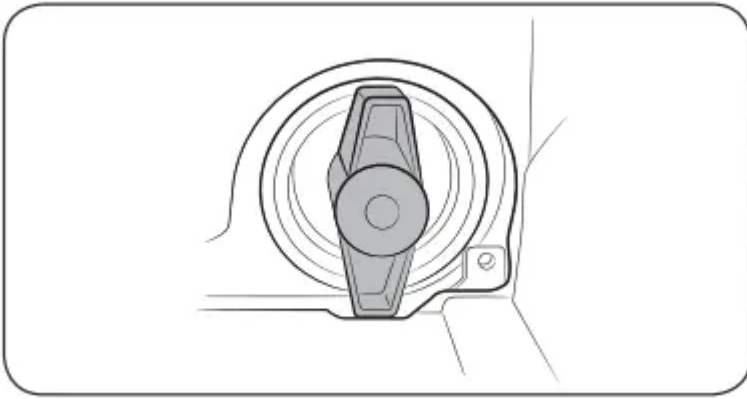

### Detergent drawer

1. While holding down the release lever inside the drawer, slide open the drawer.

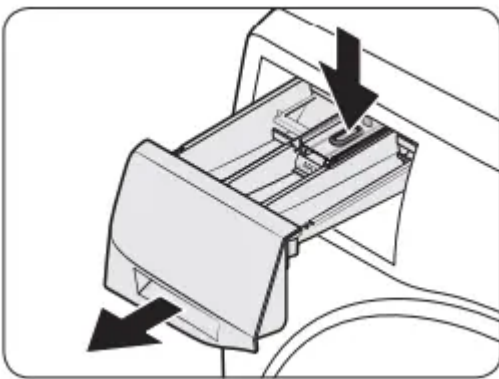

2. Clean the drawer components in flowing water using a soft brush.
3. Clean the drawer recess using a soft brush.
4. Reinsert the liquid detergent container to the drawer.
5. Slide the drawer inward to close it.

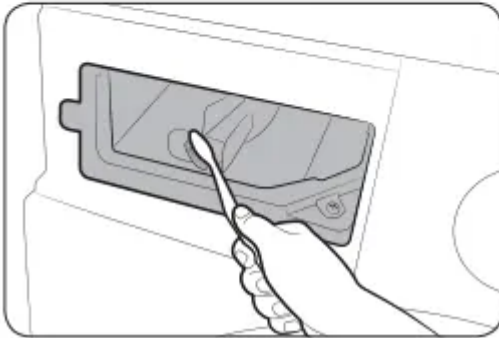
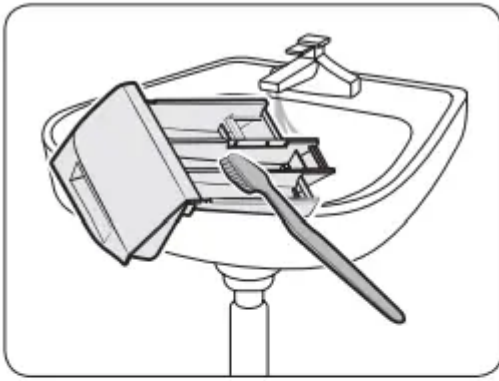

#### **NOTE**

Make sure the drawer recess is completely dry before inserting the detergent drawer.

#### **Defrosting your washing machine**

The washing machine may freeze when it drops below 0 °C.

1. Turn off the washing machine, and unplug the power cord.
2. Pour warm water over the water tap to loosen the water hose.
3. Disconnect the water hose, and soak it in warm water.
4. Pour warm water into the drum and leave it for about 10 minutes.
5. Reconnect the water hose to the water tap.

#### **NOTE**

If the washing machine still doesn't operate normally, repeat the above steps until it operates normally.

#### **Care against an extended time of disuse**

Avoid leaving the washing machine unused for an extended time. If this is the case, drain the washing machine and unplug the power cord.

1. Turn the Navigation dial to select Rinse+Spin.
2. Empty the drum, and then tap and hold .
3. When the cycle is complete, close the water tap and disconnect the water hose.





4. Turn off the washing machine, and unplug the power cord.
5. Open the door to let air circulate through the drum.

## **Troubleshooting**

If there is any problem, check the information message on the LCD screen and follow the on-screen instructions. If the problem persists, please contact the service center.

### **Checkpoints**

If you encounter a problem with the washing machine, first check the table below and try these suggestions.

Problem	Action
<b>Does not start.</b>	<ul style="list-style-type: none"> <li>• Make sure the washing machine is plugged in.</li> <li>• Make sure the door is properly closed.</li> <li>• Make sure the water taps are open.</li> <li>• Tap and hold  to start the washing machine.</li> <li>• Make sure Child Lock is not activated.</li> <li>• Before the washing machine starts to fill, it will make a series of clicking noises to check the door lock and will do quick drain.</li> <li>• Check the fuse or reset the circuit breaker.</li> <li>• Check if power is supplied properly.</li> <li>• Low voltage detected. <ul style="list-style-type: none"> <li>- Check if the power cord is plugged in.</li> </ul> </li> <li>• Make sure laundry is not caught in the door.</li> <li>• The “AddWash door is open” message appears when you open the AddWash door without tapping and holding . If this happens, do one of the following: <ul style="list-style-type: none"> <li>• Press the AddWash door to close properly. Then, tap and hold  and try again.</li> <li>• To add laundry, open the AddWash door and put in laundry. close the AddWash door completely. Then, tap and hold  to resume operation.</li> </ul> </li> </ul>
<b>Water supply is insufficient, or no water is supplied</b>	<ul style="list-style-type: none"> <li>• Fully open the water tap.</li> <li>• Make sure the door is properly closed.</li> <li>• Make sure the water supply hose is not frozen.</li> <li>• Make sure the water supply hose is not kinked or clogged.</li> <li>• Make sure there is sufficient water pressure.</li> <li>• Make sure that the cold water tap and the hot water tap are properly connected.</li> <li>• Clean the mesh filter as it may be clogged.</li> </ul>
	<ul style="list-style-type: none"> <li>• Make sure the washing machine is running with sufficient water pressure.</li> </ul>



**After a cycle, detergent remains in the detergent drawer.**

- Make sure the detergent is added to the centre of the detergent drawer.
- Make sure the rinse cap is inserted properly.
- If using granular detergent, make sure the detergent selector is in the upper position.
- Remove the rinse cap and clean the detergent drawer.

Problem	Action
<p><b>Excessive vibrations or makes noise.</b></p>	<ul style="list-style-type: none"> <li>• Make sure the washing machine is installed on a level, solid floor that is not slippery. If the floor is not level, use the levelling feet to adjust the height of the washing machine.</li> <li>• Make sure the shipping bolts are removed.</li> <li>• Make sure the washing machine is not in contact with any other object.</li> <li>• Make sure the laundry load is balanced.</li> <li>• The motor can cause noise during normal operation.</li> <li>• Overalls or clothes with metallic decorations can cause noise while being washed. This is normal.</li> <li>• Metal objects such as coins can cause noise. After washing, remove these objects from the drum or filter case.</li> <li>• Redistribute the load. If only one item of clothing needs washing, such as a bathrobe or pair of jeans, the final spin result might be unsatisfactory, and a "<b>Unbalanced laundry detected</b>" check message will be shown in the display.</li> </ul>
<p><b>Does not drain and/ or spin.</b></p>	<ul style="list-style-type: none"> <li>• Make sure the drain hose is straightened all the way to the drain system. If you encounter a drain problem, call for service.</li> <li>• Make sure the debris filter is not clogged.</li> <li>• Close the door and tap and hold .</li> </ul> <p>For your safety, the washing machine will not tumble or spin unless the door is closed.</p> <ul style="list-style-type: none"> <li>• Make sure the drain hose is not frozen or clogged.</li> <li>• Make sure the drain hose is connected to a drain system that is not clogged.</li> </ul>



	<ul style="list-style-type: none"> <li>• If the washing machine is not supplied with sufficient power, the washing machine will temporarily not drain or spin. As soon as the washing machine regains sufficient power, it will operate normally.</li> <li>• Make sure the drain hose is positioned correctly, depending on the connection type.</li> <li>• Clean the debris filter as it may be clogged.</li> </ul>
<p><b>The door does not open.</b></p>	<ul style="list-style-type: none"> <li>• Tap and hold MI to stop the washing machine.</li> <li>• It may take a few moments for the door lock mechanism to disengage.</li> <li>• The door will not open until 3 minutes after the washing machine has stopped or the power has been off.</li> <li>• Make sure all the water in the drum is drained.</li> <li>• The door may not open if water remains in the drum. Drain the drum and open the door manually.</li> <li>• Make sure the door lock light is off. The door lock light turns off after the washing machine has drained.</li> </ul>



Problem	Action
<b>Excessive suds.</b>	<ul style="list-style-type: none"> <li>• Make sure you use the recommended types of detergent as appropriate.</li> <li>• Use high efficiency (HE) detergent to prevent oversudsing.</li> <li>• Reduce the detergent amount for soft water, small loads, or lightly soiled loads.</li> <li>• Non-HE detergent is not recommended.</li> </ul>
<b>Cannot add additional detergent.</b>	<ul style="list-style-type: none"> <li>• Make sure the remaining amount of detergent and fabric softener is not over the limit.</li> </ul>
<b>Stops.</b>	<ul style="list-style-type: none"> <li>• Plug the power cord into a live electrical outlet.</li> <li>• Check the fuse or reset the circuit breaker.</li> <li>• Close the door, and tap and hold  to start the washing machine. For your safety, the washing machine will not tumble or spin unless the door is closed.</li> <li>• Before the washing machine starts to fill, it will make a series of clicking noises to check the door lock and will do quick drain.</li> <li>• There may be a pause or soak period in the cycle. Wait briefly, and the washing machine may start.</li> <li>• Make sure the mesh filter of the water supply hose at the water taps is not clogged. Periodically clean the mesh filter.</li> <li>• If the washing machine is not supplied with sufficient power, the washing machine will temporarily not drain or spin. As soon as the washing machine regains sufficient power, it will operate normally.</li> </ul>



<p><b>Fills with the wrong water temperature.</b></p>	<ul style="list-style-type: none"> <li>• Fully open both taps.</li> <li>• Make sure the temperature selection is correct.</li> <li>• Make sure the hoses are connected to the correct taps. Flush water lines.</li> <li>• Make sure the water heater is set to supply a minimum of 49 °C hot water at the tap. Also, check the water heater capacity and recovery rate.</li> <li>• Disconnect the hoses and clean the mesh filter. The mesh filter may be clogged.</li> <li>• While the washing machine fills, the water temperature may change as the automatic temperature control feature checks incoming water temperature. This is normal.</li> <li>• While the washing machine fills, you may notice just hot and/or just cold water going through the dispenser when cold or warm temperatures are selected. This is a normal function of the automatic temperature control feature as the washing machine determines the water temperature.</li> </ul>
<p><b>Load is wet at the end of a cycle.</b></p>	<ul style="list-style-type: none"> <li>• Use the High or Extra High spin speed.</li> <li>• Use high efficiency (HE) detergent to reduce oversudsing.</li> <li>• Load is too small. Small loads (one or two items) may become unbalanced and not spin completely.</li> <li>• Make sure the drain hose is not kinked or clogged.</li> </ul>



<b>Problem</b>	<b>Action</b>
<b>Leaks water.</b>	<ul style="list-style-type: none"> <li>• Make sure the door is properly closed.</li> <li>• Make sure all hose connections are tight.</li> <li>• Make sure the end of the drain hose is correctly inserted and secured to the drain system.</li> <li>• Avoid overloading.</li> <li>• Use high efficiency (HE) detergent to prevent oversudsing.</li> <li>• Check the drain hose.</li> </ul> <ul style="list-style-type: none"> <li>- Make sure the end of the drain hose is not placed on the floor.</li> <li>- Make sure the drain hose is not clogged.</li> </ul>
<b>Has odours.</b>	<ul style="list-style-type: none"> <li>• Excessive suds collect in recesses and can cause foul odours.</li> <li>• Run cleansing cycles to sanitise periodically.</li> <li>• Clean the door seal (diaphragm).</li> <li>• Dry the washing machine interior after a cycle has finished.</li> </ul>
<b>No bubbles are seen (Bubble models only).</b>	<ul style="list-style-type: none"> <li>• You may not be able to see bubbles if there is too much items in the drum.</li> <li>• Severely contaminated laundry may not generate bubbles.</li> </ul>
<b>Can I open the AddWash door at any time?</b>	<ul style="list-style-type: none"> <li>• The AddWash door can be opened only when the £+ indicator appears. However, it does not open in the following cases: <ul style="list-style-type: none"> <li>- When the boiling or drying process is running and the internal temperature becomes high</li> <li>- If you set the Child Lock for safety reasons</li> <li>- When the drum wash or drum drying cycle that does not involve additional laundry is running.</li> </ul> </li> </ul>

<b>A message appears on the display to alert that dispenser is open.</b>	<ul style="list-style-type: none"><li>• Check if the detergent drawer is closed properly.</li><li>- Open the detergent drawer and close it again. Make sure it's closed properly.</li></ul>
--	---

If a problem persists, contact a service center. The number of the service center is on the label attached to the product.

### **Information codes**

If the washing machine fails to operate, you may see an information code on the screen. Check the table below and try the suggestions.

Code	Action
<b>Check drainage</b>	<p>Water is not draining.</p> <ul style="list-style-type: none"> <li>• Make sure the drain hose is not frozen or clogged. <ul style="list-style-type: none"> <li>• Make sure the drain hose is positioned correctly, depending on the connection type.</li> </ul> </li> <li>• Clean the debris filter as it may be clogged.</li> <li>• Make sure the drain hose is straightened all the way to the drain system.</li> <li>• If the information code remains, contact a customer service centre</li> </ul>
<b>Check water supply</b>	<p>Water is not supplied.</p> <ul style="list-style-type: none"> <li>• Make sure the water taps are open.</li> <li>• Make sure the water hoses are not clogged.</li> <li>• Make sure the water taps are not frozen. <ul style="list-style-type: none"> <li>• Make sure the washing machine is operating with sufficient water pressure.</li> <li>• Make sure that the cold water tap and the hot water tap are properly connected.</li> </ul> </li> <li>• Clean the mesh filter as it may be clogged. <ul style="list-style-type: none"> <li>• All buttons will be disabled for 3 minutes after the information code appears.</li> <li>• When the "<b>Check water supply</b>" message appears, the machine drains water for 3 minutes. In the meantime, the Power button will be disabled.</li> </ul> </li> </ul>
<b>Check water lines</b>	<ul style="list-style-type: none"> <li>• Make sure the cold water supply hose is firmly connected to the cold water tap. If it is connected to the hot water tap, the laundry may be deformed with some cycles.</li> </ul>

<p><b>Unbalanced laundry detected</b></p>	<p>Spinning does not work.</p> <ul style="list-style-type: none"> <li>• Make sure laundry is spread out evenly.</li> <li>• Make sure the washing machine is on a flat, stable surface. <ul style="list-style-type: none"> <li>• Redistribute the load. If only one item of clothing needs washing, such as a bathrobe or pair of jeans, the final spin result might be unsatisfactory, and an "<b>Unbalanced laundry detected</b>" check message will be shown in the display.</li> </ul> </li> </ul>
<p><b>Door is open</b></p>	<p>Operating the washing machine with the door open.</p> <ul style="list-style-type: none"> <li>• Make sure the door is properly closed.</li> <li>• Make sure laundry is not caught in the door.</li> </ul>



Code	Action
<p><b>Addwash door is open</b> (applicable models only)</p>	<p>This message appears when you open the Add Door without pressing Start/ Pause (Hold to Start). If this happens, do one of the following:</p> <ul style="list-style-type: none"> <li>• Press the Add Door to close properly. Then, press and hold Start/Pause (Hold to Start) and try again.</li> <li>• To add laundry, open the Add Door and input laundry. Close the Add Door properly. Then, press and hold Start/Pause (Hold to Start) to resume operation.</li> </ul>
<p><b>OC</b></p>	<p>Water has overflowed.</p> <ul style="list-style-type: none"> <li>• Restart after spinning.</li> <li>• If the information code remains on the display, contact a local Samsung service centre.</li> </ul>
<p><b>LC, LC1</b></p>	<p>Check the drain hose.</p> <ul style="list-style-type: none"> <li>• Make sure the end of the drain hose is not placed on the floor.</li> <li>• Make sure the drain hose is not clogged.</li> <li>• If the information code remains, contact a customer service centre.</li> </ul>
<p><b>3C</b></p>	<p>Check the drum motor for operation.</p> <ul style="list-style-type: none"> <li>• Try restarting the cycle.</li> <li>• If the information code remains, contact a customer service centre.</li> </ul>
<p><b>3CP</b></p>	<p>The electronic control needs to be checked.</p> <ul style="list-style-type: none"> <li>• Try restarting the cycle.</li> <li>• If the information code remains, contact a customer service centre.</li> </ul>

<b>UC</b>	<p>Check the pulsator motor for operation.</p> <ul style="list-style-type: none"> <li>• Check if power is supplied properly.</li> <li>• If the information code remains, contact a customer service centre.</li> </ul>
	<p>Low voltage detected.</p> <ul style="list-style-type: none"> <li>• Check if the power cord is plugged in.</li> <li>• If the information code remains, contact a customer service centre.</li> </ul>
<b>HC</b>	<p>High temperature heating check.</p> <ul style="list-style-type: none"> <li>• If the information code remains, contact a customer service centre.</li> </ul>
<b>1C</b>	<p>The Water Level sensor is not working properly.</p> <ul style="list-style-type: none"> <li>• Turn the machine off, and restart the cycle.</li> <li>• If the information code remains, contact a customer service centre.</li> </ul>
<b>AC</b>	<p>Check communications between main and sub PBAs.</p> <ul style="list-style-type: none"> <li>• Turn the machine off, and restart the cycle.</li> <li>• If the information code remains, contact a customer service centre.</li> </ul>



Code	Action
<b>8C</b>	<p>The MEMS sensor is not working properly.</p> <ul style="list-style-type: none"> <li>• Turn the machine off, and restart the cycle.</li> <li>• If the information code remains, contact a customer service centre.</li> </ul>
<b>AC6</b>	<p>Check communications between the main and the inverter PBAs.</p> <ul style="list-style-type: none"> <li>• Depending on the state, the machine may automatically returns to normal operation.</li> <li>• Turn the machine off, and restart the cycle.</li> <li>• If the information code remains, contact a customer service centre.</li> </ul>
<b>DC1</b>	<p>The Main Door lock/unlock is not working properly.</p> <ul style="list-style-type: none"> <li>• Turn the machine off, and restart the cycle.</li> <li>• If the information code remains, contact a customer service centre.</li> </ul>
<b>DC3</b>	<p>The Add Door lock/unlock is not working properly.</p> <ul style="list-style-type: none"> <li>• Turn the machine off, and restart the cycle.</li> <li>• If the information code remains, contact a customer service centre.</li> </ul>

If any information code keeps appearing on the screen, contact a local Samsung service centre.

**Warning**

This content is compiled from multiple sources and is provided for reference purposes only. It may not be complete or fully applicable to all situations. If you are unable to resolve your issue, please contact the product manufacturer or an authorized service provider for official support.

