

KEURIG K-Supreme Manual Instructions

Get the most from your new Keurig' brewer

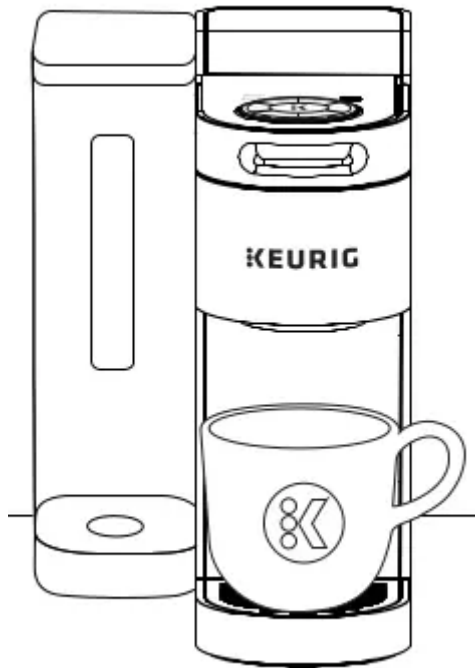

Before You Brew

1. Plug & Place

Remove packing tape from brewer. Plug into a grounded outlet

Place a large mug (10 oz minimum) on the drip tray. angling water tank position to the back, please complete before first brew (refer to instructions included).



2. Rinse & Fill

Remove the water reservoir lid, then lift the reservoir straight up to remove it. If you have a Keurig® Water Filter, install it now. Refer to your Water Filter Starter Kit for instructions.

Rinse reservoir with fresh water and fill to the MAX FILL line.

Replace water reservoir. Replace lid

NOTE: Do not use distilled water.

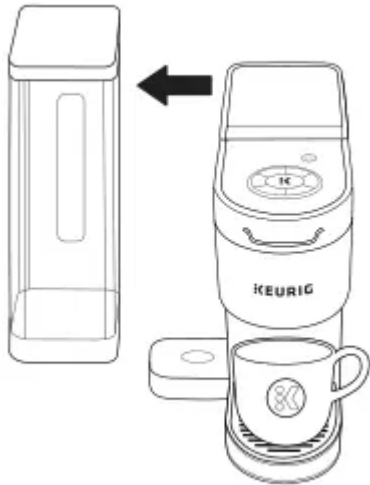

3. Lift & Lower

Lift and lower the handle. Do not insert a K-Cup pod. The brewer will power on automatically.

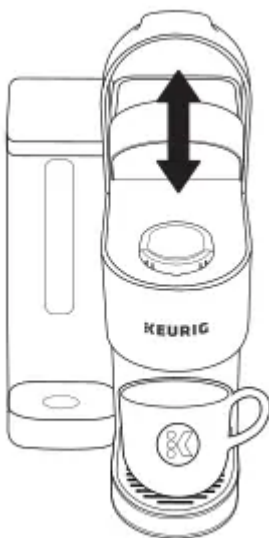

4. Cleansing Brew

The 4 cup sizes will blink. Press the 8 oz button, then press the blinking brew button to start a cleansing brew. Pour the hot water into the sink.

The one-time setup process is now complete and you are ready to brew!

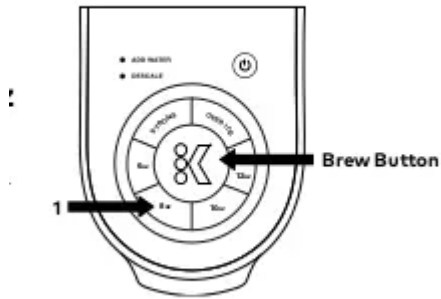

Brew Your First Cup

5. Place Mug & Pod

Place a mug on the drip tray. If using a travel mug, remove the drip tray and place the mug on the drip tray base. Lift the handle and place a K-Cup pod in the K-Cup pod holder. Lower the handle completely to close the lid

Do not remove the foil lid on the K-Cup pod.



For bolder coffee press the **STRONG** button, followed by the brew button.

For iced beverages fill a large plastic tumbler with ice. Insert any K-Cup pod, then press the **OVER ICE** button, followed by brew button.”

NOTE: choose a tumbler large enough to accommodate both the ice and dispensed liquid to prevent overflow..

Multi-position Water Reservoir Position along the left or back of the brewer to optimize counter space.

ATTENTION!

This brewer is only compatible with newly designed Keurig My K-Cup Universal Reusable Coffee Filter.

Do not attempt to use any other reusable filter or previous versions of Keurig My K-Cup Universal Reusable Coffee Filter; may cause damage to brewer.

6. Brew & Enjoy!

The 4 brew size buttons will blink. Select your brew size. then press the blinking brew button. For a stronger coffee. press the STRONG button before brewing. The brew button will remain illuminated while brewing. Brewing is complete when the buttons are no longer illuminated. Lift the handle and dispose of the K-Cup' pod.

CAUTION: While brewing. there is extremely hot water in the K-Cup pod holder. To avoid injury. do not lift the handle during the brewing process.

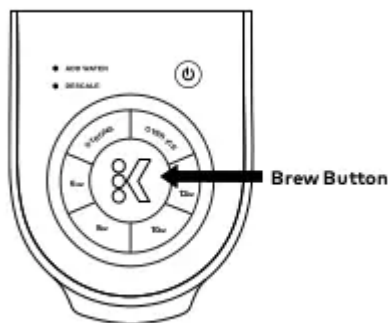

Brewer Features

Smart Start: heats then brews in one simple process. No need to wait for the brewer to heat before selecting brew size. Simply power on your brewer by lifting the handle, add a K-Cup' Pod. select your brew size, then press the brew button. The brewer will heat. then automatically begin brewing.

Auto Off : automatically turns your brewer off 5 minutes after the last brew for energy savings.

High Altitude : To ensure your brewer works properly at higher altitudes (5000 feet). enable the High Altitude setting by pressing and holding the brew button and 8 oz buttons for 3 seconds.

Strong Brew for a bolder. more intense cup.

Over Ice brew your favorite beverages over ice.

Water Tank Repositioning

1. Flip Brewer Over

Remove the drip tray and the water tank and set them aside. On a flat surface, carefully turn the brewer over so the base is facing up.

You will see two parts: the water tank base (Part B) and the locking tab (Part A).

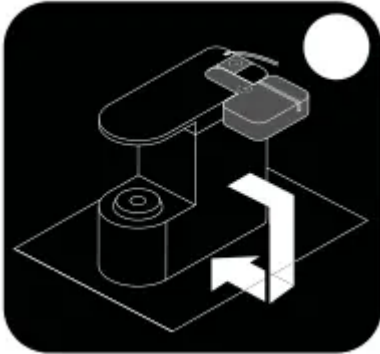

2. Remove Part A

Slide Part A out of the brewer. It should release freely with little resistance

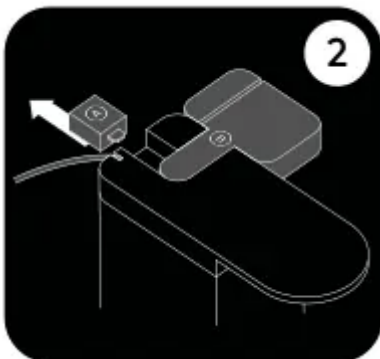

3. Pivot Part B

Next re-position part B.

- + Gently pull outward to disengage from the brewer.
- + Rotate upward, as shown above. Part B will remain attached to the brewer.
- + Part B should now pivot freely to the second position.

Remember to move the power card, so it does not get caught.



4. Insert B. Replace A

Replace Part B in its new position. Rotate downward so that B is parallel to the base. then slide B back into position.

Remember to replace the power cord

Slide Part A back into the second position to lock B in place. Flip the brewer back upright.

You are now ready to use your Keurig Brewer!

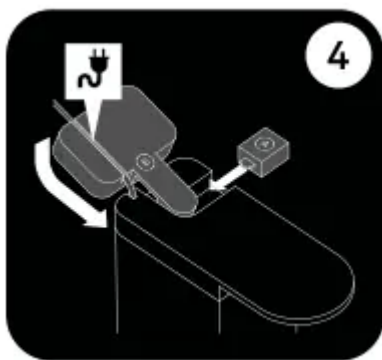

Water Filter

The Keurig K-Supreme has a spot for a water filter located in the machine's side water reservoir. The K-Supreme uses charcoal water filters measuring roughly 2 inches long by 1.125 inches tall. The filter is placed inside a BPA-free, clear plastic filter handle (typically sold separately from the brewer), which is then placed inside the water tank located on the side of the machine.

Install the Water Filter

To install the Keurig® Water Filter:

1. Soak the charcoal filter cartridge for 5 minutes in fresh water. Rinse the cartridge for 60 seconds once complete.
2. On the bottom of the handle, press in the tabs on both sides of the base at the same time and pull down to separate. Insert the filter cartridge.

3. Reattach the bottom of the Water Filter Handle.
4. Insert the handle into your empty, removable Water Reservoir. Be sure to push down firmly all the way down to correctly attach the Water Filter to the inside of your removable Water Reservoir.

How to replace Keurig K-Supreme Water Filter

Simply twist/pull the clear plastic filter housing until it comes loose from the bottom of the water reservoir. Remove the old charcoal water filter from the housing by unsnapping the bottom filter holder. Insert a new, fresh water filter cartridge and snap the filter holder back on so that the filter is securely in place. Finally, align the bottom of the filter housing with the indentations on the bottom of your water tank and push down to snap into place.

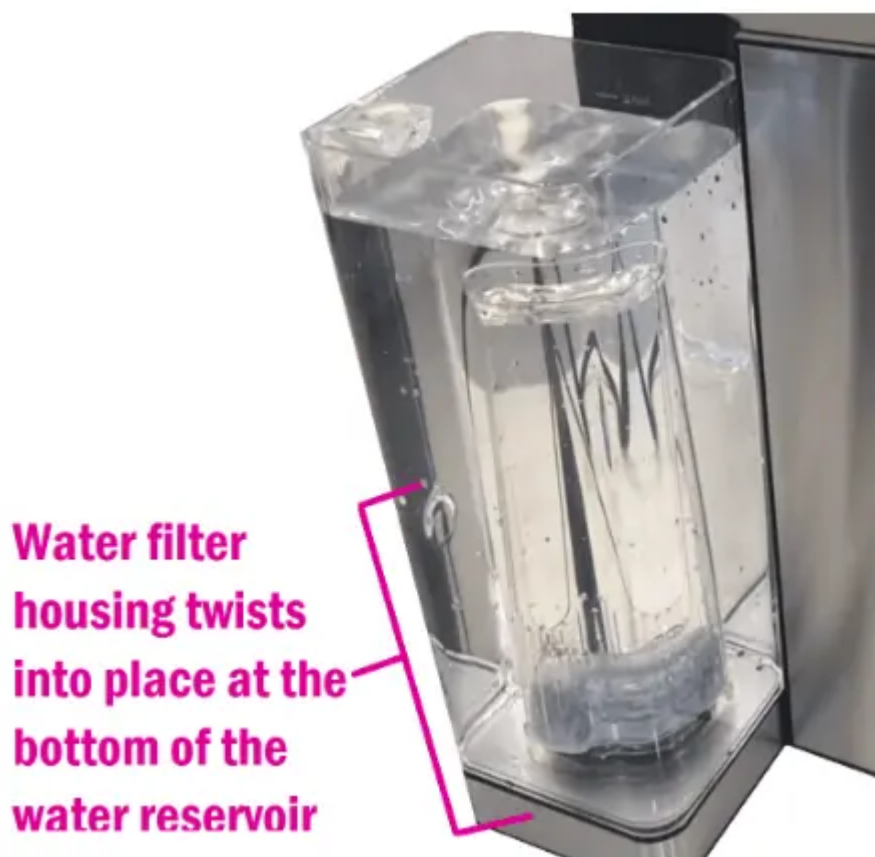

Caring For Your Brewer

Regular cleaning keeps your brewer running smoothly. Always be sure to turn off and unplug your brewer before cleaning.

Brewer Exterior

Keep your Keurig brewer looking its best by cleaning the exterior from time to time. Just clean with a damp, soapy, lint-free, non-abrasive cloth. Never immerse the brewer in water or other liquids.



Drip Tray

The drip tray can hold up to 8 ounces of overflow and should be emptied and cleaned occasionally. To remove, slide it toward you, keeping it level to avoid spilling. Rinse and clean with a damp, soapy, lint-free, non-abrasive cloth.



Water Reservoir

The water reservoir should be cleaned periodically by wiping the inside of the reservoir and underside of the lid with a damp, non-abrasive, lint free cloth. Do not dry the inside of the water reservoir with a cloth as lint may remain. Allow the reservoir to dry completely.



Regular Maintenance

For great-tasting coffee, keep your brewer running at peak performance by following the recommended maintenance schedule:

Frequency	Product	Benefit
Weekly	Keurig® Rinse Pods	Rinse away residue and oils for a great tasting cup of coffee every time
Every 2 Months	Keurig® Water Filters	Keep your water fresh and clean to enhance the taste of your coffee
Every 3 Months or when the Descale notification turns on*	Keurig® Descale Solution	Eliminate mineral build up to enhance the taste of your coffee and preserve the long-term health of your coffeemaker

* To turn off Descale notification, follow the full descaling procedure as outlined in the Use & Care Guide

K-Cup Pod Holder

To remove the K-Cup pod holder from the brewer, lift the handle and grasp the top of the K-Cup pod holder with one hand while pushing up on the bottom of the K-Cup pod holder from underneath with the other until it releases. After cleaning, align the K-Cup pod holder with the opening using the two front ribs as a guide and snap into place from the top.

CAUTION: There are sharp needles that puncture the K-Cup pad above the K-Cup pod holder and in the bottom of the K-Cup pod holder. To avoid risk of injury, do not put your fingers in the K-Cup pod holder.

NOTE: Always remove and dispose of the used K-Cup pad after brewing.

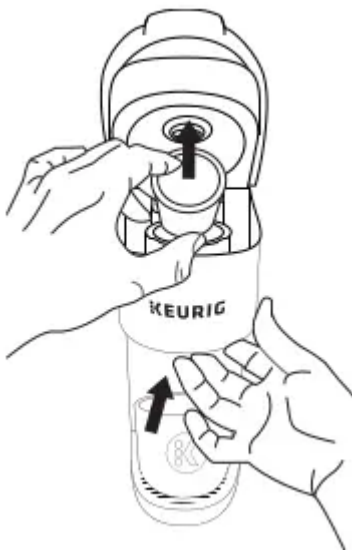

Funnel

Washing the funnel ensures a fresh beverage experience. The funnel should be washed regularly and can be removed from the K-Cup pod holder by pulling on it until it pops off. To replace it, orient the snaps to the indent and just snap it back onto the K-Cup pod holder.



Exit Needle

Remove the pod holder assembly and detach the funnel. Locate the exit needle on the inside bottom of the K-Cup® pod holder. Insert a straightened paper clip into the exit needle to loosen any coffee grounds.

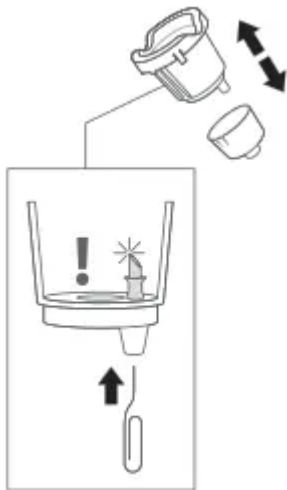

Entrance Needles

Lift the brewer handle and locate the entrance needles on the underside of the lid. To clean the holes in the needles, hold the brewer handle in the upward position and with your other hand, carefully insert a straightened paper clip into all the holes. Gently move it around to loosen any coffee grounds. Lower the handle completely and run a cleansing brew two times. Do not insert a K-Cup pod.



Descaling Your Brewer

You should descale your brewer every 3 months, or when the descale notification turns on. Properly follow the descaling procedure.

Depending on the mineral content of your water, calcium deposits or scale may build up in your brewer. Scale is non-toxic but if left unattended can hinder brewer performance.

Regularly descaling your brewer every 3 months helps maintain the heating element, and other internal parts that come in contact with water. Calcium deposits may build up faster, making it necessary to descale more often.

Descaling Procedure

Before you begin, you will need a large ceramic mug, fresh water, Keurig Descaling Solution, and access to a sink.

Do not use a paper cup. Ensure that there is no beverage pod in the K-Cup pod holder. Please allow approximately 15-20 minutes for the descaling procedure.

You will need: a large ceramic mug, fresh water, Keurig Descaling Solution, and access to a sink. Do not use a paper cup. Ensure that there is no beverage pod in the K-Cup pod holder. The descaling procedure takes approximately 20 minutes.

STEP 1: Prepare the Brewer

Pour the entire bottle of Keurig Descal Solution into an empty water reservoir. Then, fill the empty bottle with water and pour into the water reservoir. Do not insert a K-Cup pod. Place a large mug on the drip tray.

STEP 2: Descal the Brewer

To activate Descal Mode, begin with the brewer plugged in and powered off, then press and hold the 8 oz and 12 oz buttons together for 3 seconds. When flashing, press the brew

button to start the descaling process. Once the brew is complete, pour the hot liquid into the sink. Repeat this step until the ADD WATER light illuminates.

STEP 3: Fresh Water Rinse

Empty and rinse the water reservoir and refill to the MAX fill line with fresh water. When flashing, press the brew button to start the rinsing process. Once the brew is complete, pour the hot liquid into the sink. Repeat this step until the DESCALE notification turns off. The brewer has now exited Descale Mode and will be ready for use!

NOTE: The cleaning action of Keurig Descaling Solution may result in a "foam" dispensed from the brewer. This is natural, as the solution is reacting with the scale inside. For a brewer that is heavily scaled, the brewer may not fill properly after the descaler is added. If this occurs, you may see only a small or no output dispensed, followed by the sound of air blowing out. If this occurs:

+ Turn off and unplug the brewer.

+ If there is Keurig Descaling Solution in the water reservoir, discard the contents, rinse the water reservoir thoroughly and refill with water.

+ Plug the brewer back in, power on, and repeat the Step 3 Fresh Water Rinse cycle. The brewer should begin to function normally as the solution is rinsed out and the scale is removed. If the problem persists, allow the brewer to sit

Unplugged for at least 30 minutes before continuing with the rinse.

Troubleshooting

Grounds in Your Coffee

Grounds may have gathered in the exit or entrance needles and can be cleaned using a straightened paper clip or similar tool.

+ Clean the exit needle of the K-Cup pod holder. Refer to the Exit Needle care instructions.

+ Clean the brewer entrance needles. Refer to the Entrance Needles care instructions.

Brewer Will Not Brew

+ A minimum of 6 oz of water is required to brew. Add an additional 2 oz of water to the reservoir to ensure the minimum fill level has been met, then press the brew button. Repeat until the brewer begins to dispense.

Brewing a Partial Cup

+ Power the brewer off. Press and hold the brew button and 12 oz button for 5 seconds until water starts dispensing.

Then release and let the water purge. Discard the contents into the sink. Press the power button to restart.

- + The exit needle may be clogged. Refer to the Exit Needle care instructions.

- + Clean the K-Cup Pod Holder, see K-Cup Pod Holder care instructions.

- + The brewer may need to be descaled. If you have repeated the descale procedure on your brewer two times and it is still only brewing a partial cup, contact Customer Service.

Brewer Does Not Have Power or Shuts Off

- + Make sure that the power button has been turned on.

- + Plug brewer into its own grounded outlet. If the electric circuit is overloaded with other appliances, your brewer may not function properly. The brewer should be operated on its own circuit. separate from other appliances.

- + For energy savings. the brewer automatically turns off 5 minutes after the last brew. Press the power button to restart.

- + If the brewer still doesn't have power. contact Customer Service.

Introduce Information

K-Supreme - SINGLE SERVE COFFEE MAKER

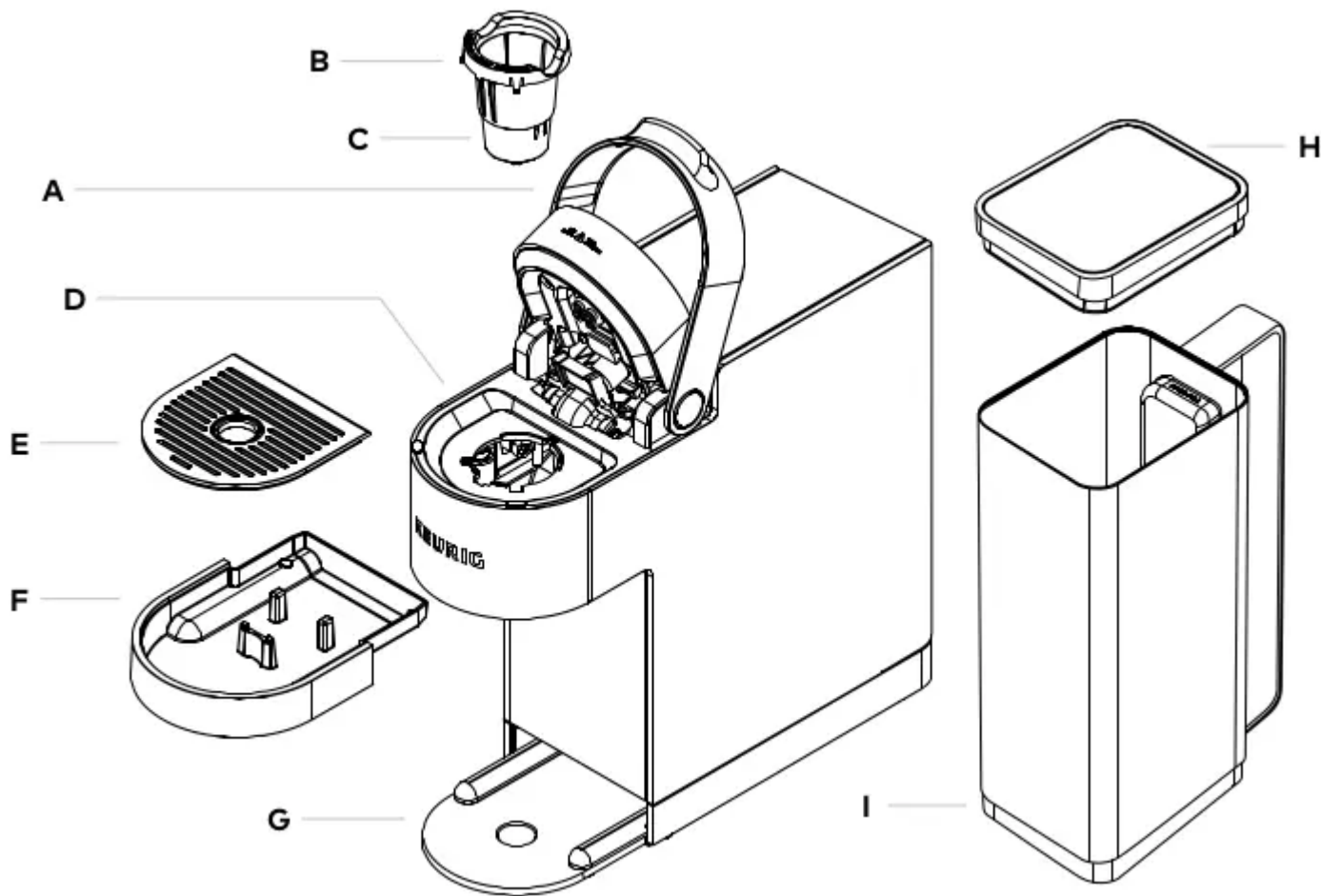

A Handle

B K-Cup Pod Holder (B and C are the K-Cup Pod Holder Assembly)

C Funnel

D K-Cup Pod Assembly Housing

E Drip Tray Plate

F Drip Tray

G Drip Tray Base

H Water Reservoir Lid

I Water Reservoir

Helpful Hints.

Water quality varies greatly. If you notice an undesirable taste in your beverage (such as chlorine or mineral tastes), we recommend using bottled or filtered water. Do not use distilled water.

Service.

Beyond these recommended cleaning and maintenance procedures, this brewer is not user serviceable. For service, please refer to the Warranty section of this guide.

Storage.

Empty the water reservoir before storing or transporting and take care to ensure that you store your brewer in a safe and frost-free environment. When you prepare to use it after storage, we recommend rinsing the water reservoir with fresh water and descaling the brewer as detailed in the.

Descaling your Brewer section.

If you plan to move your brewer to a different location, turn the brewer off, unplug it, and empty the water reservoir.

If your brewer has been in an environment below freezing, please be sure to let it warm to room temperature for at least 2 hours before using.

Customer Service

Have Questions?

We're here to help. Visit support.keurig.com for step-by-step videos on cleaning, descaling, and more.

Still Need Help?

Give us a call at.

1-866-901-BREW (2739)

Warning

This content is compiled from multiple sources and is provided for reference purposes only. It may not be complete or fully applicable to all situations. If you are unable to resolve your issue, please contact the product manufacturer or an authorized service provider for official support.