

Built-in Bottom Freezer Refrigerator

CAUTION:

DO NOT STARE AT OPERATING LAMP. MAY BE HARMFUL TO THE EYES.

- If this appliance is replacing an existing appliance which must be removed or disposed of, make sure that it does not become a dangerous trap for children by cutting its power supply cable and rendering it impossible to close the door. Use the same caution at the end of the lifespan of the new appliance.
- This appliance is designed to refrigerate beverages and foods and is intended for domestic use.
- The appliance must be installed by following the instructions in the Installation Guide. particular care should be taken not to obstruct the vent openings of the appliance and of the built-in units.
- The appliance features a concentrated lighting system with LED lamps. Do not stare into these lamps when they are on to avoid possible eyesight damage.
- This warning is also contained on the label attached to the inside of the refrigerator door.
- When the freezer is functioning do not touch the inner surfaces in stainless steel with wet or damp hands, since skin may stick to the very cold surfaces.
- Do not use any type of electrical equipment inside of the food conservation compartments.
- When positioning the shelves, do not place fingers in the shelf slide guides.
- Do not position containers of flammable liquids near the appliance.
- Completely switch off the appliance and unplug the power supply cable during cleaning operations. If the plug is not easily reached, it is a good idea to turn off the breaker or remove the fuse that controls the socket that the appliance is connected to.
- The packaging parts can be dangerous for children: do not allow children to play with the plastic bags, plastic film or Styrofoam.
- Any repairs must be performed by a qualified Service technician.
- This appliance is not intended for use by persons (including children) with reduced physical, sensory or lack of experience and knowledge unless they have been given supervision or instruction concerning use of the appliance by a person responsible for their safety. Children should be supervised to ensure that they do not play with the appliance.
- Do not damage the appliance refrigerant circuit pipes.
- Do not store explosive substances such as aerosol cans with a flammable propellant in this appliance.

Important directions for safety and the environment

Caring for the environment

- Pay special attention to correct disposal procedure for all the packaging materials.
- The appliance must not be disposed of with urban waste. Contact local waste disposal centers for on how to dispose of recyclable waste.
- Prior to disposal. cut the power supply cord and make it impossible to close the door.
- During disposal. avoid damage to the refrigeration circuit.
- The appliance does not contain hazardous substances for the atmospheric ozone layer. neither in the refrigeration circuit nor in the insulation.

Cleaning, sanitization and maintenance of the ice and/or water dispenser (if present)

- Failure to follow the instructions regarding sanitizing can compromise the hygienic safety of the water dispensed.
- When using the appliance for the first time and every time the filter is changed. it is recommended to let the water flow in the circuit using the “Manual Cleaning” and discard the ice produced in the first 24 hours.
- If the water dispenser has not been used for more than 4/5 days. it is advisable to clean the circuit and run off the first litre of water.
- Reposition the removable water dispenser (if present). ensuring your hands are hygienically clean.
- Clean the ice bucket or drawer regularly but using only drinking water.
- The filter must be changed when indicated on the control panel or when the ice/water dispenser has not been used for more than 30 days.
- With each filter replacement. sanitise the ice and/or water distribution system using a food grade disinfectant (with sodium hypochlorite). which does not alter the characteristics of the materials. or use the “Sanitising Kit” available from the After-Sales Service. Rinse with at least 2 litres of water before use.
- Only original spare parts supplied by the manufacturer should be used when replacing components in the ice and water dispenser.
- Any work on the appliance must be carried out by a qualified technician or the After-sales Service.

INSTALLATION

1. Make sure that installation is performed correctly. adhering to all directions in the specific installation manual provided with the appliance.

2. Connection to the electrical power supply

The appliance operates at 115 V AC, 60 Hz and is equipped with a power supply cord with a 3-prong grounded plug, which must be connected to a corresponding 3-prong (15 Amp) grounding-type wall receptacle.



- Do not use extension cords and/or multiple adapters for the power supply connection.
- DO NOT connect the refrigerator to any GFCI receptacle.

3. Connection to the water system

- The models provided with Ice Maker require a connection to the domestic water supply system. This can be executed through the 1/4" water line (copper or polyethylene) to the house water supply.
- The system pressure must be between from 8 psi to 75 psi (between 0.5 bar and 5 bar). Different pressures can cause malfunctions or leaks in the water system.
- The appliance should be supplied only with drinkable water.
- Refer to the installation manual for the water connection.

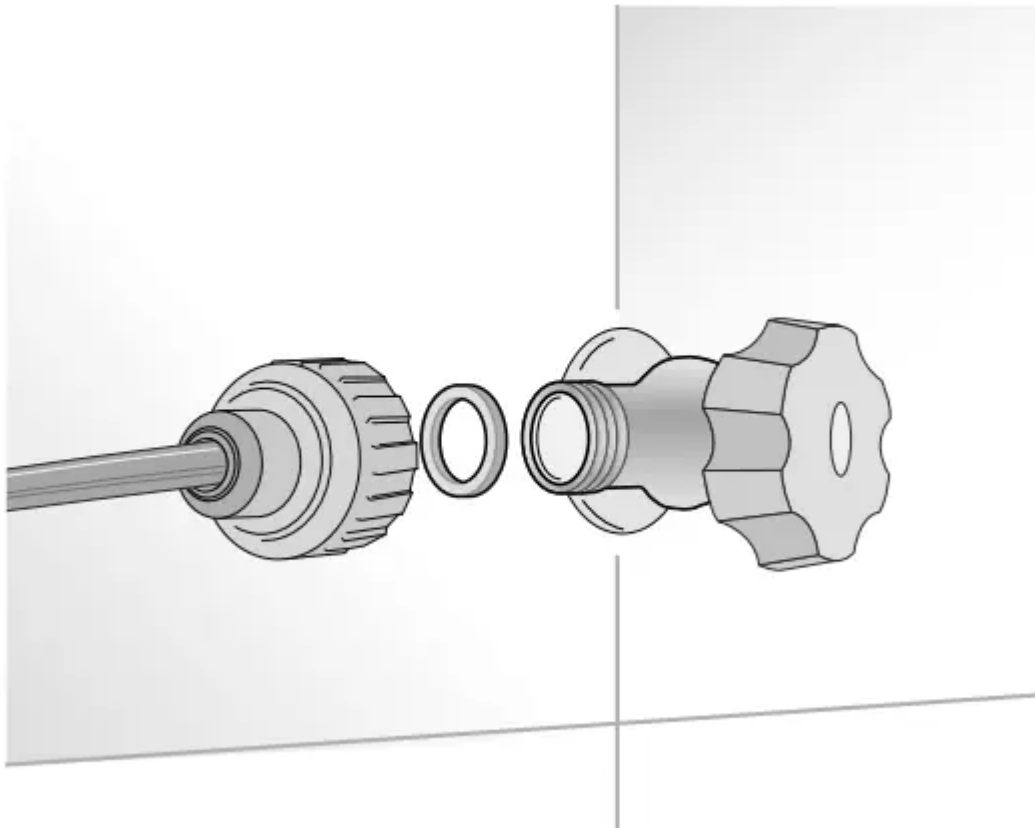

- The appliance should be supplied only with drinkable water.
- Make sure that installation is performed correctly, according to all of the directions in the specific installation manual provided with the appliance.
- Do not attempt to use a locally sourced garden hose threaded adapter or braided supply line. It will strip the threads on the appliance water connection sole noid.

BEFORE STARTING

Main features

- The refrigeration system and the efficient separation of internal compartments ensures maximum freshness and offers excellent conservation of foods in the three compartments: refrigerator, Fresco and freezer
- It is also possible, should there be a need, to further increase the flexibility of the appliance by making the freezer compartment operate as a refrigerator or as a Fresco compartment
- The Fresco compartment has a low temperature and controlled humidity, providing excellent conservation in superior preservation conditions for fresh foods
- Electronic control guarantees constant temperature and humidity levels set by the user and provides real-time compartment temperature readings.

- An interactive menu (Menu) allows customized management of appliance functions and the visualization of functioning messages
- Power save features to reduce consumption during vacation periods
- Ample drawer space with Soft self-closing systems in the Fresco area
- Ice Maker for automatic ice production of variable cube size
- Easily replaceable water filter located inside the refrigerator
- Patented adjustable shelf system. with shelves that can be positioned at any level inside of the refrigerator without having to be removed
- Stainless steel surface both inside and outside. with fine aluminum trim
- Patented hinge system that permits automatic door closing
- External drawers with to self-closing system
- Localized lighting with LEDs
- Anti-tipping system by means of wall mounting brackets

Main components

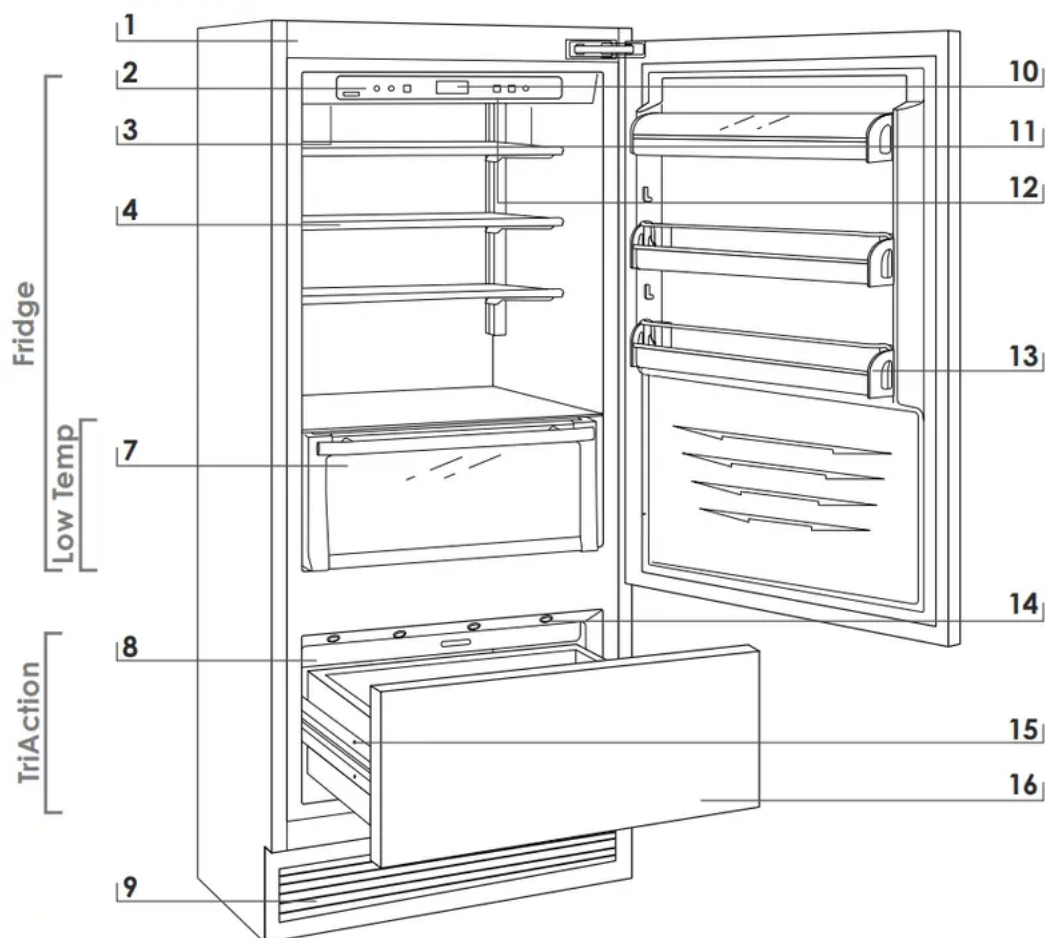

1. Stainless steel structure with
2. Control panel with Menu

3. Water Filter
4. Patented shelf positioning
5. Control panel. Fresco area
6. Fresco compartment with
7. Low Temp" drawer with
8. Automatic icemaker
9. Double refrigeration system
10. Temperature display
11. Sound signals
12. Vacation function
13. Spacious door shelves
14. Innovative lighting
15. Automatic door and
16. Frezer compartment that can be transformed into a refrigerator or Fresco compartment (TriAction function)

Electronic Control

The innovative electronic control system maintains constant temperature in multiple compartments and displays it on the control panel. It also allows user interaction making it possible to personalize settings of various functions and to alert the user with sound and/or visual messages should any malfunction occur in the appliance.

Main control panel

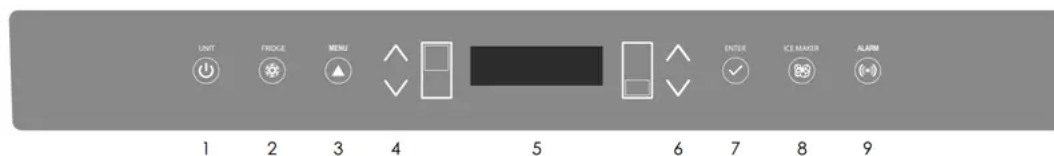

1		Unit	Switches the appliance (all compartments) between ON and STAND BY (press for three seconds).
2		Fridge	Allows switching on and off of only the refrigerator compartment (press for three seconds).
3		Menu	Allows access to the appliance function menu
4		Up/down Fridge	Using the Up and Down buttons. it is possible to change the set temperature of the refrigerator and navigate through the interactive menu.
5		Display	It shows the temperature of the refrigerator and freezer compartments. the date and time. Menu functions and visual messages.
6		Up/Down Freezer (TriAction)	By selecting Up/Down the preset temperature can be changed according to the selected function mode (freezer. refrigerator. Fresco-Fresco).
7		Enter	Confirms activation or deactivation of the selections made in the Menu.
8		Ice maker	Allows activating or deactivating the automatic ice production.
9		Alarm	Blinks to signal user alerts such as door left open. also in combination with a sound signal which can be deactivated by pressing the button.

APPLIANCE SWITCHING ON AND OFF

Switching on and off

First startup

When the appliance is connected to the electrical power supply but has not yet been switched on.

the display shows the message **Stand by**

This is a safety message to warn that the appliance is connected to the mains. and all the panel buttons are off.

To switch on all the appliance compartments. press the Unit button  for three seconds.

Switching off the Refrigerator and Fresco compartments

When the appliance is first switched on the TriAction compartment is set to the “freezer” mode. After switching on it remains always on and can be switched off only by switching off the complete

appliance. press the Unit button  for three seconds

Restarting

Use the same buttons to restart.

The freezer compartment always stays on and cannot be switched off except by completely

switching off the appliance by pressing the Unit button  for three seconds.

Switching off for long periods

During long absence periods it is recommended to switch off the refrigerator by pressing the Unit

button  for three seconds and disconnect

Completely empty the refrigerator. clean and dry it and leave the doors and drawers partially open to prevent unpleasant odors.

NOTE:

- If at the first startup the Standby message does not appear. but another message appears. it means that the appliance has already started the cooling process. If this is the case. Deactivate any possible sound signal by pressing the Alarm button close the door and wait until

- During the first startup, it will not be possible to use the Menu to modify the factory settings until the preset temperature has been reached.
- Each time the appliance is switched on it goes through a self-diagnosis procedure lasting three minutes before completely starting up.
- If only the refrigerator compartment or the Fresco compartment is switched off, the specific fan will continue to operate to prevent the formation of unpleasant odors and mold.
- Before switching off the appliance for a long period of time, remove all of the items inside and leave the doors and drawers open to prevent the formation of unpleasant odors and mold.

How to adjust the temperature for different requirements

Each model has been carefully tested before leaving the factory and is adjusted in such a way to ensure high performance and low consumption. Usually, it is not necessary to modify the settings. Nevertheless, according to special needs, it is possible to modify the set temperatures as follows:

Refrigeration Compartment

From +1°C to +7°C (from 33. °F to 44. °F), the recommended preset temperature is +4°C (39. °F).



To adjust the temperature use the Up/Down buttons . Upon touching these buttons the newly set temperature will appear in the display. To modify this temperature, use the buttons until reaching the desired temperature.

Fresco-Fresco Compartment

From -2°C to +2°C (from 28.4°F to 35.6°F), the recommended preset temperature is 0°C (32°F).



To adjust the temperature use the Up/Down buttons . Upon touching these buttons the newly set temperature will appear in the display. To modify this temperature, use the buttons until reaching the desired temperature.

Freezer Compartment (TriAction)

From -13°C to -23°C (from 8. °F to -9. °F), the recommended temperature is preset at -18° (0°F).



To adjust the temperature use the Up/Down buttons . Upon touching these buttons the newly set temperature will appear in the display. To modify this temperature. use the buttons until reaching the desired temperature.

In case the compartment is used as refrigerator or Fresco compartment (TriAction function) the recommended and preset temperatures will correspond to those indicated for the respective compartments.

NOTE

- The temperature shown can vary slightly in respect to the set temperature following frequent openings of the doors or insertion of room temperature foods or large quantities of foods.
- 6 to 12 hours are necessary to reach the selected temperature.

Ice Maker Activation



The Ice Maker button  located on the main control panel permits activation of the automatic icemaker. The button is lighted when the icemaker is functioning.

NOTE Do not activate the Ice Maker unless the appliance is connected to the water mains.

Information and malfunction messages on the display

An integrated control system provides information through light signals or text messages visualized on the display.

The information signal is always visualized with a fixed text message. while a malfunction signal is visualized with blinking text. The sound signal that accompanies some malfunction signals can be



deactivated by pressing the Alarm button  on the main control panel.



The list of malfunction signals is located at the back of this manual.



SETTING AND SPECIAL FUNCTIONS

Customization and language settings

It is possible to customize the functions of your refrigerator to adapt it to diverse usage needs, resetting the main parameters (Settings) or activating special functions (Functions).

Functions are accessed on the main display by pressing the Menu button 



The Up/Down buttons  permit navigation of the available functions, which can be selected by pressing the Enter button . The display shows the current function status.

Using the Up/Down buttons , it is also possible to scroll through the selected function's sub-menu if applicable, activating or deactivating by pressing the Enter button .

Once the function is confirmed, the display will automatically step back to the main menu to allow selection of other functions.

At any time it is possible to return to the previous selection through the Access button 

The language of the messages appearing on the display can be changed by operating as follows:

Enter the Menu by pressing the Menu button  select Settings via the Up/Down buttons  and confirm via Enter . Then select the Language function and the desired language.

Special functions activated through the Menu

Shopping Fridge

The function lowers the refrigerator temperature to +2°C (35.6°F) for 12 hours, permitting more rapid cooling of food that has just been placed in. Once the 12 hours have expired, the function deactivates automatically, returning to the previously set temperature. It is possible to program a timed activation of the function. After a prolonged interruption of electrical current, it is necessary to reactivate the function.

How to activate	<p>Functions → ⓪ → ⚡ Shopping Fridge → ⓪ → ⚡ Shopping Fridge ON/OFF → ⓪ → ⚡ Shopping Fridge On</p>
How to deactivate	<p>Functions → ⓪ → ⚡ Shopping Fridge → ⓪ → ⚡ Shopping Fridge ON/OFF → ⓪ → ⚡ Shopping Fridge Off</p>
How to program timed activation	<p>Functions → ⓪ → ⚡ Shopping Fridge → ⓪ → ⚡ Shopping Time → ⓪ → ⚡ Set Hours: 1 → ⓪</p> <p>It is possible to program the function with a delay of 1 to 12 hours</p>

Vacation Fridge

This function (recommended in case of prolonged absences since it allows considerable energy savings) brings the refrigerator compartment temperature to +14°C (57.2°F). It is possible to program the duration. or it can be manually deactivated upon returning after a period of absence.

This function remains active even if during the period of absence there is a prolonged interruption of electrical power.

NOTE

The various Shopping Modes help prepare the cooling, Fridge and TriAction compartments for the introduction of a heat load which can consist of fresh food or other items which may have warmed during transport. The more quickly an item can be cooled or frozen the better it will be preserved.

This mode can also be effective at maintaining compartment temperatures while entertaining when higher than average door and drawer openings are anticipated.

How to activate	<p>Functions → → Vacation Fridge → → Vacation ON/OFF → → Vacation Fridge On → </p>
How to deactivate	<p>Functions → → Vacation Fridge → → Vacation ON/OFF → → Vacation Fridge Off → </p>
How to program the duration	<p>Functions → → Vacation Fridge → → Vacation Time → → Set Days: 1 → </p> <p>It is possible to program the function with a delay of 1 to 12 hours.</p>

Shopping TriAction

This function must be activated at least 24 hours before inserting room temperature items into the freezer. or several hours before placing into the freezer previously frozen items which have been subject to a slight temperature rise. This function is automatically deactivated when the programmed time period expires. It is possible to program timed activation of the function.

If interrupted by a prolonged interruption of the electrical power, it is necessary to reactivate the function.

How to activate	<p>Functions → → Shopping TriMode → → ShoppingTriMode ON/OFF → → Shopping TriMode On → </p>
How to deactivate	<p>Functions → → Shopping Fridge → → ShoppingTriMode ON/OFF → → Shopping TriMode Off → </p>
How to program timed activation	<p>Functions → → Shopping TriMode → → Shopping Time → → Set Hours: 1 → </p> <p>It is possible to program the function with a delay of 1 to 12 hours.</p>

Vacation TriAction

This function (recommended in case of prolonged absences since it allows considerable energy savings) brings the TriAction compartment temperature to - 18°C (46.4°F). It is possible to program the duration, or it can be manually deactivated upon re-entry after a period of absence.



This function remains active even if during the period of absence there is a prolonged interruption of electrical power.

How to activate	<p>Functions → [OK] → [Up] Vacation TriMode → [OK] → [Up] Vacation ON/OFF → [OK] → [Up] Vacation TriMode On → [OK]</p>
How to deactivate upon re-entry	<p>Functions → [OK] → [Up] Vacation TriMode → [OK] → [Up] Vacation ON/OFF → [OK] → [Up] Vacation TriMode Off → [OK]</p>
How to program the duration	<p>Functions → [OK] → [Up] Vacation TriMode → [OK] → [Up] Vacation Time → [OK] → [Up] Set Days: 1 → [OK]</p> <p>It is possible to program the function with a delay of 1 to 12 hours.</p>

Bottle Cooler

This function can be activated when it is necessary to cool off beverages quickly. by placing them inside the freezer compartment.

It is possible to select a duration of 1 to 45 minutes. A sound signal will indicated when the optimal temperature has been reached. After removing the beverages. deactivate the sound signal by

pressing the Alarm button .

How to activate	<p>Functions → [OK] → [Up] Bottle Cooler → [OK] → [Up] Bottle Cooler ON/OFF → [OK] → [Up] Bottle Cooler On → [OK]</p>
How to deactivate	<p>Functions → [OK] → [Up] Bottle Cooler → [OK] → [Up] Bottle Cooler ON/OFF → [OK] → [Up] Bottle Cooler Off → [OK]</p>
How to program the duration	<p>Functions → [OK] → [Up] Bottle Cooler Set Cooling Time → [OK] → [Up] Set time : 20 min → [OK]</p>

IceMaker

The IceMaker function permits selecting the size of the ice cubes. by choosing between Large (base setting) or Medium. and activation of the SuperIce function. which increases the quantity of produced ice.

The SuperIce function deactivates automatically after 24 hours.



How to activate the cube size function	<p>Functions → [OK] → [Up] Ice Maker → [OK] → [Down] Set Cube Size → [OK] → [Up] Size Large → [Down] → [OK]</p>
How to deactivate	<p>Functions → [OK] → [Up] Ice Maker → [OK] → [Down] Set Cube Size → [OK] → [Down] Size Medium → [Down] → [OK]</p>
How to activate the SuperIce function	<p>Functions → [OK] → [Up] Ice Maker → [OK] → [Down] SuperIce ON/OFF → [OK] → [Down] SuperIce On → [Down] → [OK]</p>
How to deactivate	<p>Functions → [OK] → [Up] Ice Maker → [OK] → [Down] SuperIce ON/OFF → [OK] → [Down] SuperIce Off → [Down] → [OK]</p>

Sabbath Mode (Optional)

The function makes it possible to comply to certain religious observances requiring that the operation of the appliance is not affected by the opening or closing of the doors (the thermostatic control, the inner lighting and the ice maker are deactivated).

How to activate	<p>Functions → [OK] → [Down] Sabbath Mode → [OK] → [Down] Sabbath Mode ON/OFF → [OK] → [Down] Sabbath Mode On → [Down] → [OK]</p>
How to deactivate	<p>Functions → [OK] → [Down] Sabbath Mode → [OK] → [Down] Sabbath Mode ON/OFF → [OK] → [Down] Sabbath Mode Off → [Down] → [OK]</p>

Water Filter

The View Status function permits visualizing the time left before the filter needs to be replaced.

How to check the status of the filter	<p>Functions → [OK] → [Down] Water Filter → [OK] → [Down] Filter Status → [OK] → [Down] View Status → [OK]</p>
--	--

Reset Filter

The Reset Filter function sets to zero the time left before the filter needs to be replaced. It is necessary to set the meter to zero each time the cartridge is replaced.

How to set the filtered water meter to zero	<p>Functions → [OK] → [Down] Water Filter → [OK] → [Down] Filter Status → [OK] → [Down] Filter Reset → [OK]</p>
--	---



Bypass Filter

This function is to be activated when it is not necessary to filter the water. because excellent quality water is already available from the home water system.

How to activate filter Bypass	Functions → [Enter] → Water Filter → [Enter] → Filter Status → [Enter] → Filter Bypass → [Enter] → Filter Bypass On → [Enter]
	Functions → [Enter] → Water Filter → [Enter] → Filter Status → [Enter] → Filter Bypass → [Enter] → Filter Bypass Off → [Enter]

Before proceeding it is important to turn off the ice maker by pressing button





Manual Clean, Water Filter

If ice production has been disabled or unused for a long period it is recommended to perform a Manual Clean function to flush out water which has sat in the system during this period. Repeat the operation until the water is clean.

How to manually clean the filter	Functions → [Enter] → Water Filter → [Enter] → Manual Clean → [Enter] → Enter to confirm → [Enter]
---	---

NOTE Correctly position the ice tray or another suitable container under the IceMaker to collect water. then close the drawer. At the end of the operation. wash the tray.

Basic settings of the Menu

Select the Menu button  and used the Up/Down button  to select Settings.

TriAction Options

The freezer compartment can, if required, be converted to refrigeration or Fresco-Fresco operating mode.

How to set the Fridge function	Settings → ⊙ → ⬆️ TriAction Options → ⊙ → ⬆️ Fridge → ⊙ Enter to confirm → ⊙
How to set the Fresco function	Settings → ⊙ → ⬆️ TriAction Options → ⊙ → ⬆️ Fresco → ⊙ Enter to confirm → ⊙
How to revert to the Freezer function	Settings → ⊙ → ⬆️ TriAction Options → ⊙ → ⬆️ Freezer → ⊙ Enter to confirm → ⊙



Default Setting

This offers the possibility to reset default factory settings and cancels any previous changes.

How to reset default settings	Settings → ⊙ → ⬆️ Default Setting → ⊙ Enter to confirm → ⊙
--------------------------------------	---

ATTENTION: If the default settings are restored, the default mode of the TriAction compartment is freezer mode. If it was previously being used in refrigerator or Fresco mode be sure to set it back to your desired setting.

Set Date The display will show the date in the format dd:mm:yy (day:month:year). the day will

blink. Use the Up/Down buttons  to modify the setting. confirm with Enter  to go on to the next setting; once the year is confirmed with Enter to go on to the next setting; once the year is confirmed the date will be set.

How to set the date	Settings → ⊙ → ⬆️ Date → ⊙ → ⬆️ Set Date → ⊙ DATE: 01-01-2009 → ⊙
----------------------------	--

Show Date Using this function it is possible to deactivate/activate the date being shown on the display.

How to activate the date	Settings → ⊙ → ⬆️ Date → ⊙ → ⬆️ Show Date → ⊙ → ⬆️ DATE: 01-01-2009 On → ⊙
How to deactivate the date	Settings → ⊙ → ⬆️ Date → ⊙ → ⬆️ Show Date → ⊙ → ⬆️ DATE: 01-01-2009 Off → ⊙

ATTENTION: If the default settings are restored, the default mode of the TriAction compartment is freezer mode. If it was previously being used in refrigerator or Fresco mode be sure to set it back to your desired setting.

Set Time

The display shows the hours and minutes in the format hh:mm and with hh: blinking. Use the Up/



Down buttons

to modify the setting and then confirm by pressing Enter



to go on to the next setting. Once the minutes are confirmed, the time will be set

<p>How to set the time</p>	<p>Settings → [Enter] → [Up] Time → [Enter] → [Up] Set Time → [Enter] TIME: 01:01 → [Enter]</p>
-----------------------------------	--

Set 12/24

<p>How to set the display to 12 h</p>	<p>Settings → [Enter] → [Up] Time → [Enter] → [Down] Set View → [Enter] → [Down] Set12 → [Enter] → [Down]</p>
<p>How to set the display to 24 h</p>	<p>Settings → [Enter] → [Up] Time → [Enter] → [Down] Set View → [Enter] → [Down] Set24 → [Enter] → [Down]</p>

Show Time Through this function it is possible to activate/deactivate the constant display of the time.

<p>How to activate the time display</p>	<p>Settings → [Enter] → [Up] Time → [Enter] → [Down] Show Time → [Enter] → [Down] TIME: 01:01 On → [Enter]</p>
<p>How to deactivate</p>	<p>Settings → [Enter] → [Up] Time → [Enter] → [Down] Show Time → [Enter] → [Down] TIME: 01:01 Off → [Enter]</p>

Language



Italian	Settings → Ⓞ → ⚡ Language → Ⓞ → ⚡ italiano → Ⓞ
English	Settings → Ⓞ → ⚡ Language → Ⓞ → ⚡ english → Ⓞ
French	Settings → Ⓞ → ⚡ Language → Ⓞ → ⚡ français → Ⓞ
German	Settings → Ⓞ → ⚡ Language → Ⓞ → ⚡ deutsch → Ⓞ
Spanish	Settings → Ⓞ → ⚡ Language → Ⓞ → ⚡ español → Ⓞ

Set °C/°F

This function permits showing the temperature in Centigrade or Fahrenheit degrees. Normally, the appliance is set for display in centigrade degrees.

How to set the temperature in Centigrade	Settings → Ⓞ → ⚡ Set 'C/'F → Ⓞ → ⚡ Set 'C → Ⓞ
How to set the temperature in Fahrenheit	Settings → Ⓞ → ⚡ Set 'C/'F → Ⓞ → ⚡ Set 'F → Ⓞ

INTERNAL LAYOUT

Fresco Drawer Fixed to the slide guides with two thumbscrews.

	to remove the drawer, unscrew the thumbscrews and remove the drawer
--	---



TriAction Drawer The upper TriAction can be removed using the same method used for the Fresco drawer

	<p>to remove the inner TriAction drawer unscrew the thumbscrews.</p> <p>When replacing the drawers, make certain the back of the drawers engage under the clips on the slide guides.</p>
--	---

Ice Tray Located in the upper drawer of the freezer compartment

	<p>after removal, make sure to reposition it correctly - small protrusions from the bottom of the ice bin should align with holes in the upper freezer drawer.</p> <p>! Do not place hands or fingers near the Icemaker when functioning</p>
--	---

Shelves It is recommended that the shelves be emptied prior to adjusting the position. The shelves are sliding and can be easily re-positioned by the user as follows:

	<ul style="list-style-type: none"> • release the locking knob by turning it counter-clockwise • support the back of the shelf and tilt up at the front
	<ul style="list-style-type: none"> • lift or lower the shelf to the desired position • re-tighten the locking knob • to remove a shelf it is necessary to slide it up to the top

Door Shelves The door shelves can be easily removed for cleaning

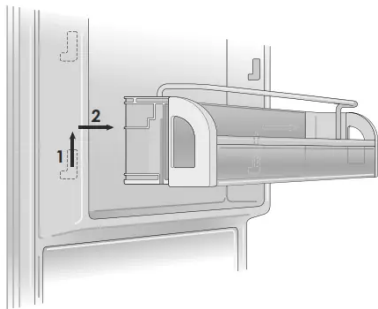
	<ul style="list-style-type: none"> • Hold the door shelf at the sides and push it upwards to release it from its seat, then pull it outwards. • Reverse the procedure to reinstall.
---	---

ICE MAKER USE AND ACTIVATION

Activation and use of the Ice Maker

NOTE

If the ice is not used frequently is advisable to empty the ice bin once every 8-10 days.

It is normal that some ice cubes stick to one another. If the ice is not frequently used. the older cubes can become opaque. and will have a strange flavor and become smaller.

The Icemaker automatically deactivates if the Vacation function is activated.

When the Icemaker is started for the first time. it is recommended to dispose of the first full bin of ice.

If the equipment has been switched off for a month or more. it is recommended to perform a water cleaning cycle. (See section 5: Set tings and Special Functions).

The ice maker will only produce ice with the TriAction compartment set to Freezer Mode.

The ice maker will continue to operate even when the ice bin is not in position.

To activate the Ice Maker after installation of the appliance. press the Icemaker button



Please note that 12 to 24 hours are necessary before ice production may begin. The production is of 10 cubes per cycle in approximately 10 cycles in 24 hours.

The yield depends on the temperature set in the freezer. the room temperature and the frequency of door opening. If the appliance is operating without being connected to the water system. make



sure that the Icemaker is deactivated by pressing the button

The Ice Maker produces ice until the ice tray is full and will automati cally stop once the maximum level is reached.

With the SuperIce function. it is possible to increase the quantity of ice produced a 24 hours. while the Set Cube Size function permits selec tion of the size of the produced ice cubes.

At factory default settings Ice Maker can produce approx. 100 ice cubes within 24 hours.

Do the ice cubes have an unusual odor?

Ice is a porous material which can absorb odors from the environment.

Ice cubes which have been in the ice cube container for a long time may absorb odors. stick together and slowly become smaller.

We recommend that old ice cubes not be used.

Other means of preventing odors:

- The ice cube container should be cleaned occasionally with warm water. Make sure that you switch off the ice maker before clearing the container. Rinse out and wipe dry.
- Check the contents of the freezer for spoiled or out-of-date food.
- All odorous foods should be wrapped thoroughly or stored in airtight containers to prevent the build-up of odors.
- The water filter may have to be replaced in some models.
- In some cases the quality of the water connection in the house should be checked.

Operating noises/ Quite normal noises

- Grumbling: refrigerating unit is running. Fan in the recirculating air system is running.
- Bubbling, humming or gurgling noises: refrigerant is flowing through the tubes.
- Clicking: motor is switching on or off. Solenoid valve on the water connection is opening/closing.
- Rumbling: ice cubes are falling into the ice cube container.
- **Note:** the appliance is powered by two independent compressors.

It is therefore normal to always have one of two compressors in operation.

Water Filter

The Water Filter makes available high-quality water for the production of ice cubes. It provides up to 3000 liters of water for a maximum time of 12 months.

When the filter is nearly expired the message "Replace Filter Cartridge" will appear on the display.

Filter Replacement

The filter is located inside the refrigerator compartment, above the top glass panel. Prior to changing the filter, switch off the Ice Maker by pressing the IceMaker button. Then enter the Access Menu and set "Manual Clean" function. At the end of the cleaning cycle remove the water from the ice tray and wipe it dry.

Open the top glass panel and carefully rotate the filter cartridge for a quarter rotation in a counter clockwise direction until it detaches from its housing. It is normal for a small quantity of water to come out. Remove the cap of the new cartridge and insert it into the housing by gently rotating it for a quarter rotation in a clockwise direction until it locks into place.

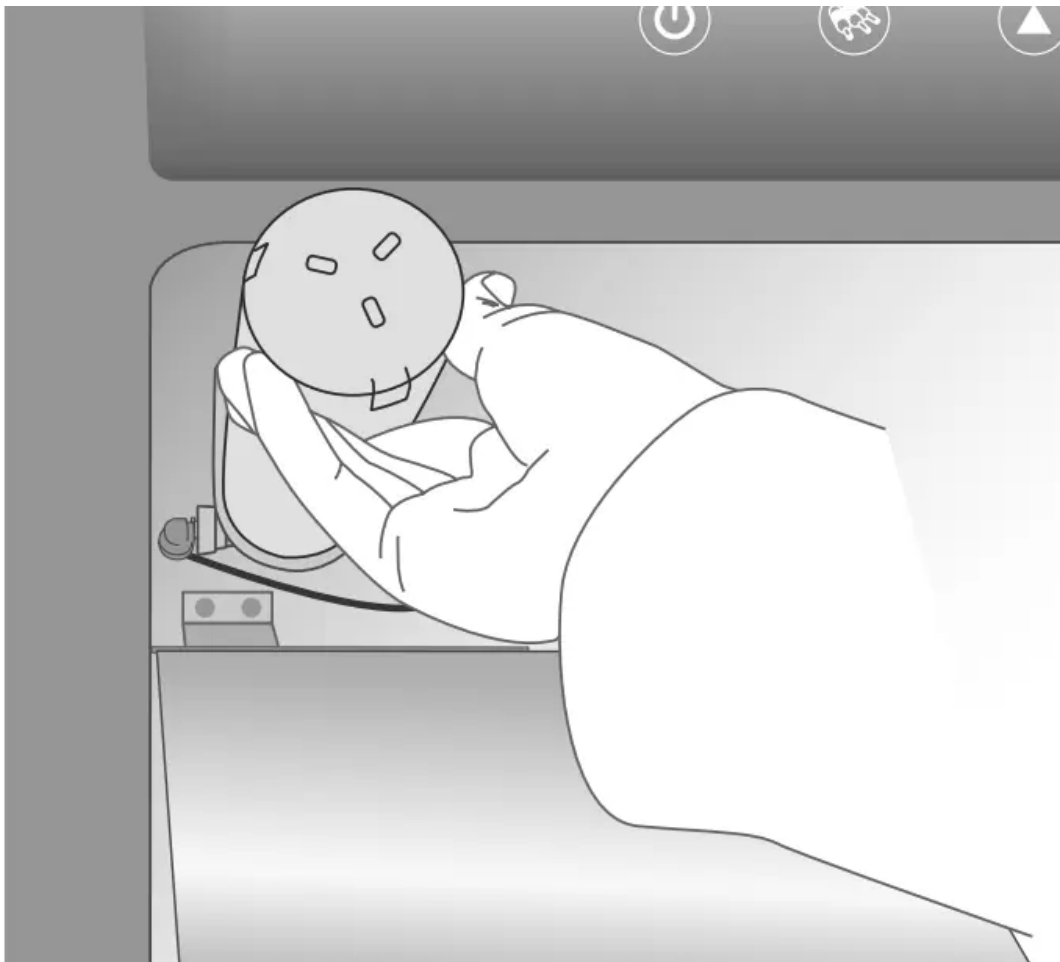

LIGHTING

Lighting

To provide optimum interior lighting. LED strips illuminate the refrigerator compartment from the top and sets of LED lights directly illuminate different areas of the refrigerator compartment. of the Fresco-Fresco drawers and the freezer drawer.

In case of malfunction and/or wearing out of the lighting system. the repair should be carried out by a qualified Service technician.

FOOD PRESERVATION

General directions

Your refrigerator is designed to ensure precise. constant temperatures and appropriate humidity levels in all compartments.

In addition, the double refrigeration ensures that frozen foods and ice do not absorb the odor of fresh foods and that the humidity in the refrigerator does not freeze and build up frost.

Nevertheless, to properly preserve all of your foods, it is not enough to have an excellent refrigerator. It is also necessary to know the rules for correct food preservation.

Do bear in mind that all foods will inevitably change their characteristics over the passage of time. This change begins long before the food is consumed, since foods contain microorganisms which multiply and can cause deterioration. This process occurs more rapidly due to improper handling, preservation temperatures and humidity levels.

It is therefore recommended to follow the directions presented below which will permit using your refrigerator/freezer in the most effective and safe manner to keep your foods in the best way for as long as possible.

Bear in mind that the Fresco area is the area for preserving the most delicate fresh foods, since it ensures constant average temperature near freezing.

Periodically check that all foods are in a perfect state of preservation. It is usually quite clear when a food item is deteriorated, due to mold, unpleasant odor and unpleasant aspect. Nevertheless, there are cases in which these conditions are not so evident. If you believe that a food item was kept for an excessive period of time and may be deteriorated, do not consume this item or even taste it, even if it seems to still be healthy, since the bacteria that cause deterioration of food can also cause poisoning and illness.

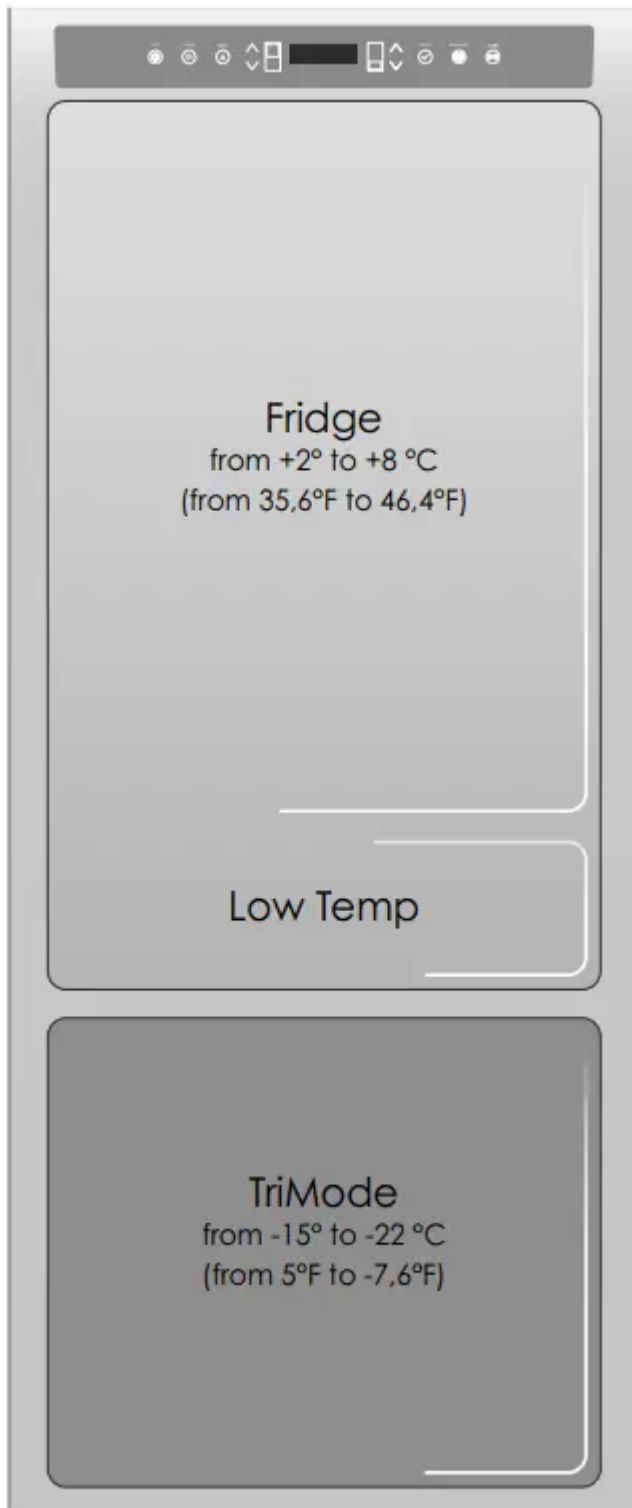

How to maintain good food quality

When buying groceries

Always take the following precautions:

- Place any packages of raw meat, fish or poultry in plastic bags so that they do not drip on other foods.

- Purchase meat, poultry and fish last. Do not leave your groceries in a warm car after shopping. Keep a freezer bag in your car and use it in case of very high temperatures or long trips.
- Check the production dates and “best before” times on foods to be sure that they are fresh.
- Be very careful when buying fresh foods, and only buy a quantity that can be consumed during your planned preservation period.
- When possible, let warm foods adjust to room temperature for at least two hours before placing them in the refrigerator, unless you have activated the Shopping function before.

When placing foods in

Check the refrigeration temperature of the various compartments on the control panel:

- The refrigerator temperature must be 8°C (45°F) or lower and the freezer temperature must be -18°C (0°F)
- Follow the recommendations regarding the preservation times and temperatures indicated in the tables to follow.
- Keep raw meat, fish and poultry separate from other foods and avoid any possible drippings.
- To keep food in the freezer it is a good idea to use freezer containers, with plastic freezer bags or aluminum foil around the freezer containers, if you intend to preserve the food for more than two months. This will minimize dehydration and deterioration.

When placing foods in

- When placing in the refrigerator your meat, fish or poultry, leave these in their original packaging, unless the packaging is ripped or punctured. Repeated handling could introduce bacteria into these foods.
- To keep food in the freezer is a good idea to use freezer containers, with plastic freezer bags or aluminum foil around the freezer containers, if you intend to preserve the food for more than two months. This will minimize dehydration and deterioration
- Label and date the packages
- To keep foods in the refrigerator, wrap these in plastic film or deposit them in plastic containers or vacuum-packed containers to avoid drying. Always mark with the date the packages or containers.
- Be careful to correctly position the food items on the shelves in a way that does not obstruct the air circulation vents inside the compartment.

When preparing food

- Wash all items that have come in contact with food Carefully wash hands before and after contact with food Sterilize containers. utensils and kitchen tools that have come into contact with meat. fish and poultry.
- Sterilize sponges used to wash kitchenware weekly.
- Use plastic gloves if you have any hand condition.
- Defrost foods in the refrigerator or in the microwave oven. not on the countertop. If you use a microwave oven to defrost food. cook the food immediately.
- Marinate food only in the refrigerator.
- Rinse fish and poultry before cooking.
- Avoid contamination when preparing dishes. Keep raw meat. fish. poultry and their liquids away from other food items.

For example. do not use the same surface or the same utensils for preparing meat. fish. poultry and vegetables.

- Keep your cutting boards perfectly clean. whether made from wood or plastic.
- Wash cutting boards with warm water and soap. and rinse with a diluted disinfecting solution.
- Defrost foods in the refrigerator or in the microwave oven. not on the countertop. Bacterial growth can increase on the outside of partially thawed food while the interior remains frozen if defrosting at room temper ature for longer periods. If you use a microwave oven to defrost food. cook the food immediately.

When cooking food

- Do not taste raw or partially cooked meat. poultry. fish and eggs.
- Cook meat at a temperature of 75°C (167°F) or higher.
- For cuts of meat over 5 cm. use a meat thermometer to check the temperature. For thinner cuts of meat. to check if it is cooked. check the color of the juice and whether it is clear or pink.
- If you are cooking meat which is not yet defrosted. increase the cooking time one and half times the normal duration.
- Bear in mind that roasted meat and poultry. when cooked in the oven. need temperatures of 160°C (320°F) or higher.
- Cook the egg whites and yolks until they are well done.
- Do not use the same containers that have contained raw or par tially cooked eggs.
- If your oven or microwave is equipped with a probe for temperature control. use it - internal temperatures are the best gauge for deter mining cooking completion.

When you have leftovers

- Keep leftovers in the refrigerator or in the freezer in small closed containers. Before placing them in the refrigerator, make sure that they have cooled off. Therefore let at least two hours pass after cooking and make sure that there is adequate air circulation around the container, so that the food can cool off quickly - this practice avoids increasing the temperature in the fridge / freezer compartment and subsequent cooling cycles as a result.
- Date leftover containers and use them within the recommended time.
- Completely cover and heat leftovers before serving.
- Boil sauces and soups. Consume leftovers after they have been heated to a temperature of at least 75°C (167°F).
- If you think the food is gone bad, or when in doubt, throw it away.

If the layer of ice is thicker, it might be necessary to shut off the Fresco compartment for one day in order to melt it.

A characteristic unique to products is the combination of micro beaded stainless steel Fresco drawers and the main stainless steel interior liner that help generate and maintain optimum internal humidity levels for extended preservation of fruit and vegetables.

A natural condition that may occur, is the accumulation of water on the bottom of the refrigeration compartment below the bottom Fresco. This is dependant on a number of factors, ambient temperature and humidity levels in the surrounding environment, moisture levels on fruit and vegetables placed in the refrigerator, frequency in which the main door is opened and exposed to the ambient environment.

This temporary presence of water on the bottom is the result of the high humidity environment maintained in the compartment and is absolutely normal, and under normal operating conditions should be eliminated. However, in rare occasions where there may be an excessive amount of condensation simply remove the bottom drawer and wipe excess water away. When a high level of humidity is present either in the environment or in the foods placed in the Fresco drawers, the bottom of the Fresco compartment might be covered with some water or ice (if the temperature is set between 0°C and C°).

Such condition is normal and it is due to the high humidity levels of the Fresco compartment; high humidity together with low temperatures is what guarantees a longer preservation of foods.

Water or ice can disappear on its own if the air humidity level should lower; it is also possible to remove the water with a towel. If a thin layer of ice has formed, set the temperature of the Fresco compartment to +2°C and after one day remove the water with a towel.

Recommendations for preserving fresh food

Vegetables Wash vegetables in cold water and dry well. Place vegetables in vacuum packed containers, plastic containers or vegetable bags in a Fresco Drawer.

Fruit Wash and dry fresh fruit. Pack very aromatic fruit in plastic bags.

Fruit should be placed in the high humidity Fresco compartment.

Packaged meat Place in the refrigerator in its original packaging.

After opening, wrap the remaining food in plastic bags or aluminum foil.

Fresh meat, fish and poultry Remove the original packaging, then put in plastic bags or containers and immediately place in the refrigerator.

Eggs Place the eggs in their package or container into the refrigerator without washing them. Check the "best before" date and at any rate use the eggs within two weeks of purchasing.

Milk, cream and fresh cheeses These should be kept in their original closed packaging. Place these on refrigerator shelves and consume these within five days of purchase.

Cheeses Place these in the Fresco drawer in their original packaging.

Once opened, close these hermetically in plastic bags or aluminum foil.

Leftovers Let these cool off and cover hermetically with aluminum foil or place in sealed containers to prevent drying or the spread of odors.

Recommendations for preserving fresh food

Frozen food Place food in plastic bags for the freezer. These bags must be hermetically sealed against air and humidity. Do not refreeze defrosted meat.

Ice cream The firmness of ice cream depends on the quantity of cream that it contains. In general, high-quality ice cream has large amounts of cream, therefore a very low temperature in the freezer will be necessary to maintain its firmness.

Consequently, ice cream without much firmness is not necessarily an indication of a temperature problem as raised above normal levels.

NOTE

After a prolonged interruption of electrical power, once the electrical power is reactivated, an audible signal will indicate if the temperature has raised above normal levels. In addition to this the display will show for one minute the highest temperature detected inside the compartments, to allow the user to decide how to better use the food items.

After one minute the display will resume normal operation, while the Alarm button will

Care and Cleaning

Condenser cleaning

- To clean the parts made of steel use a microfiber cloth and the sponge provided in the kit with the appliance. Always use the cloth and sponge in the direction of the steel's satin finish.
- Every now and then, to polish the steel, wipe with a slightly damp micro fiber cloth.
- Do not use the sponge on aluminium parts, such as the handles and the profiles of the glass shelves.
- You should use special care to keep the ventilation openings in the appliance or in the cabinet that houses it free of obstructions.

NOTE

- Scrupulously follow the detailed directions that can be found in the provided kit and never use abrasive or metallic products which could scratch and damage the satin finishing on the appliance permanently.
- Before performing any sort of cleaning, disconnect the appliance from the electrical power supply.
- Make sure you do not damage the refrigerant circuit in any way.
- The edges of the condenser are sharp, therefore use adequate protection for the hands and arms when cleaning the condenser.

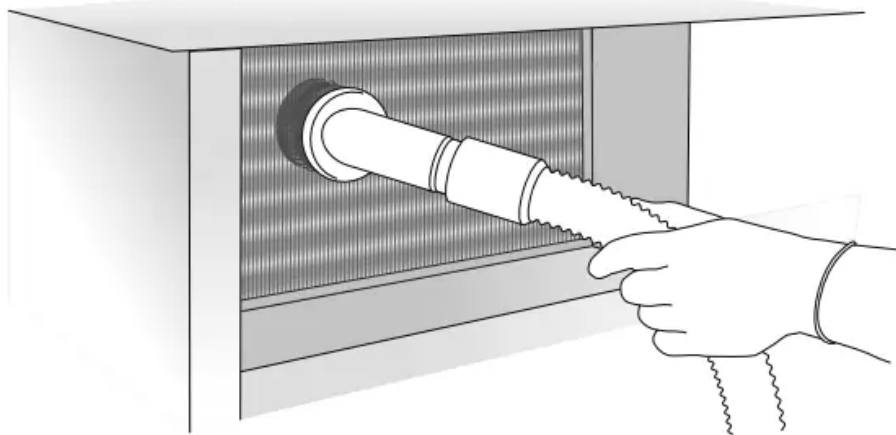
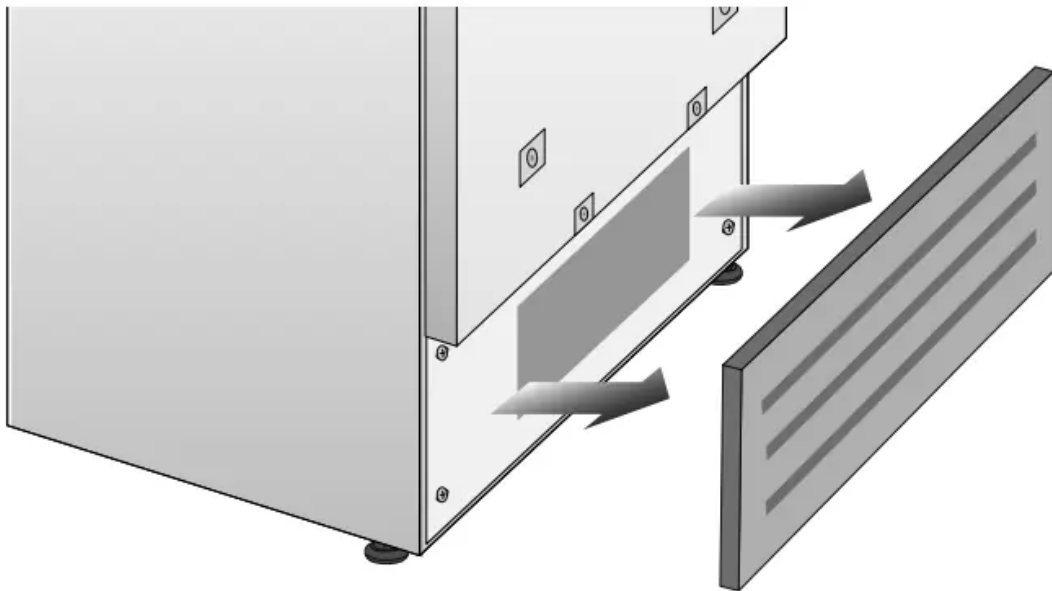

- A ventilation grille is located either at the bottom of the appliance.
- A foam filter is placed behind the grille to protect from dust the ventilation system (for only StandPlus series)
- To clean it use a vacuum cleaner with a soft brush attachment at maximum power, sweeping it along the vent slits. In case of a significant dust build up, the ventilation grille can be removed to allow a more accurate cleaning of the filter.
- Take care also to check the condition of the finned condenser and clean it from dust if needed.

Operate as follows:

1. Switch off the appliance by pressing the Unit button  on the main control panel for approx 3 seconds
2. On models with ventilation at the base remove the grille at the bottom magnetically attached) and take it off. On models with ventilation lift the grille as shown in the picture.

3. Thoroughly clean the grille and the foam filter, by means of a vacuum cleaner and the soft brush attachment.
4. Wait approx 30 minutes, until the finned condenser cools down to room temperature, then clean it thoroughly from any dust build up as shown in the picture, taking care not to damage it.
5. Start up the appliance again, by pressing the Unit button on the main control panel for approx 3 seconds.

Internal cleaning

- Clean the internal and removable parts by washing them with a solution of lukewarm water. a small amount of dishwashing detergent.
- Rinse and dry right away.
- Do not use mechanical devices or other methods to speed up defrosting.

Do not bring cold glass parts into contact with boiling water.

NOTE

- Do not wash any parts of the refrigerator in a dishwashing machine since this could damage or irreparably deform the parts.
- Do not use water on the electrical parts. lights and control panel.

TROUBLESHOOTING

If you notice malfunctions in your appliance. use this guide before calling for service: this guide can help you personally resolve the problem or could provide important information to be conveyed to the service technician to ensure rapid and effective repair.

Malfunction message

- A malfunction is usually indicated by a message on the display.
- Problems that cannot be solved by the user are signaled through a malfunction code.

The refrigerator or the freezer does not work

- Is the appliance connected to the electrical power supply?
- Is electrical power available at the electricity socket?
- Is the Unit button activated?
- Is the unit in Demo' Mode?

The refrigerator or the freezer is warmer than usual

- Does the display show a malfunction code?
- Is the temperature adjusted correctly?

- Were the doors or drawers open for a long period of time?
- Were large quantities of food recently inserted?
- Is the unit in Demo' Mode?

The appliance remains in function for a long time period

- Bear in mind that during very hot weather and with very high temperatures in the room it is normal that the compressor remains on for prolonged periods of time.
- Were the doors or drawers open for a long period of time?
- Were large quantities of food recently inserted?
- Check that the doors are closed and that the food or containers do not obstruct the perfect closure of the door.
- Is one or more compartments in Shopping Mode?

If you hear unusual noises

- It is normal to hear noises from the ventilators or compressors during operation or during the defrost phase.
- Noise could be more marked depending on the position of the appliance and the surrounding environment.

Condensation inside and outside

- If the climate is very humid, the formation of condensation is normal.
- Opening the door or drawers for prolonged periods of time can contribute to the formation of condensation.
- In any case, make sure that the doors are always perfectly closed.

Ice or frost build up inside the refrigerator or freezer

- Did you leave the doors open for a long period of time?
- Do the doors close perfectly?
- If the doors do not close perfectly, contact your installer.
- In case of frost or ice build up in the Fresco compartment, due to frequent and prolonged opening of the doors, deactivate the Fresco function via the button on the control panel. Wait until the frost or ice melt, then remove the drawer and dry the sides and bottom of the compartment.

Unpleasant odors inside the refrigerator

Clean the appliance completely according to the instructions. Hermetically cover all the food. Do not conserve food for prolonged periods of time.

The doors are difficult to open

The appliance is designed to ensure a fully hermetic closure. When the door is closed, a vacuum condition can occur: in this case it is necessary to wait a few seconds until the pressure balances before opening the door.

Appliance is cooling but lights and display are not working

Check to see if the appliance was accidentally placed into Sabbath Mode

The Ice Maker does not work

Make sure that the Ice Maker is on (Icemaker button on).

To switch on the Ice Maker press the button.

Make sure that the appliance is connected to the water supply.

The Ice Maker does not produce sufficient amounts of ice

On average, the Ice Maker produces approximately 10 cubes of ice every two and half hours.

The ice cubes freeze into one block

If the ice is not used frequently, it is possible that blocks of ice may form. It is recommended to remove the block of ice cubes and then let the Ice Maker fill the ice tray again.

The ice has an unusual flavor or color

- When the Ice Maker is started for the first time, it is recommended to empty the first full tray of ice cubes.
- If the refrigerator was switched off for more than one month or if the cartridge was not changed for more than six months, it could be necessary to replace the filter cartridge.
- Contact a plumber or a water treatment expert to make sure that the problem is not due to the water supply.

NOTE If the unit you purchased was used as a showroom model it may be in a special energy-saving mode called Demo Mode where the appliance appears to be operating (lights work and false temperatures are displayed) but no cooling actually takes place. If you suspect your appliance is in Demo Mode please contact your point of purchase for assistance with disabling this feature.

Malfunction indications appearing on the display

Display message	Malfunction description
Power Failure!!	Prolonged interruption of electrical power the appliance resumes operation automatically. the display shows the warmest temperatures achieved
Door Fridge OPEN	Fridge door open the message appears after a few minutes from the door opening
TriAction OPEN	TriAction drawer open the message appears after a few minutes from the drawer opening
Replace filter	Replace filter cartridge message appears when only 30% of filter capacity is left
Fridge too warm	Fridge too warm see Troubleshooting Guide
Fridge too cold	Fridge too cold wait for 12 hours: if malfunction persists call Customer Care for advice
Fresco too warm	Fresco Compartment too warm see Troubleshooting Guide
Fresco too cold	Fresco Compartment too cold wait for 12 hours: if malfunction persists call Customer Care for advice
TriAction too warm	reezer too warm see Troubleshooting Guide
TriAction too cold	Freezer too cold wait for 12 hours: if malfunction persists call Customer Care for advice
Error Code	Functional problems call Customer Care who may help you to solve the problem or put you in contact with the nearest Service Agent

Warning

This content is compiled from multiple sources and is provided for reference purposes only. It may not be complete or fully applicable to all situations. If you are unable to resolve your issue, please contact the product manufacturer or an authorized service provider for official support.

