

Features

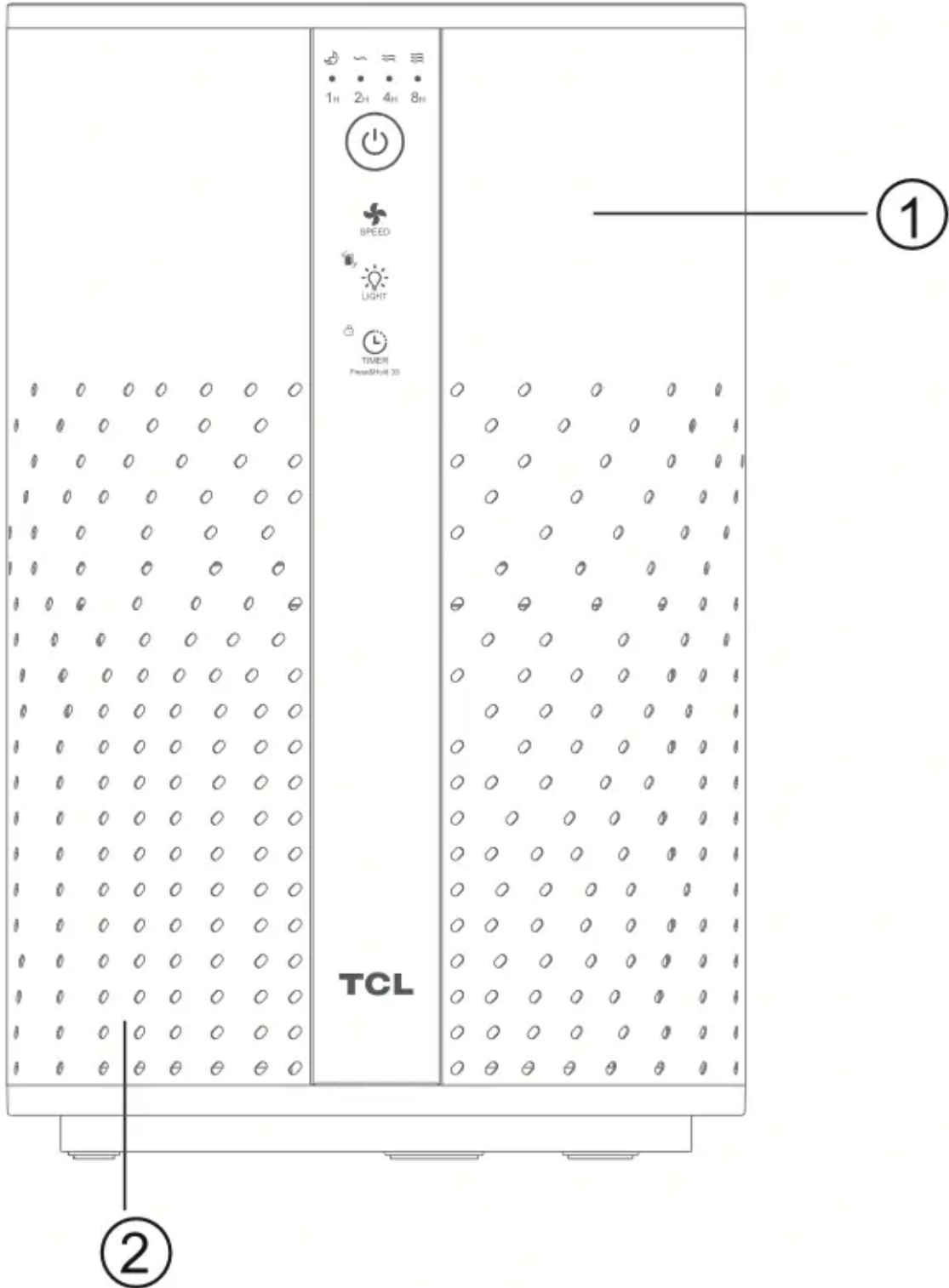

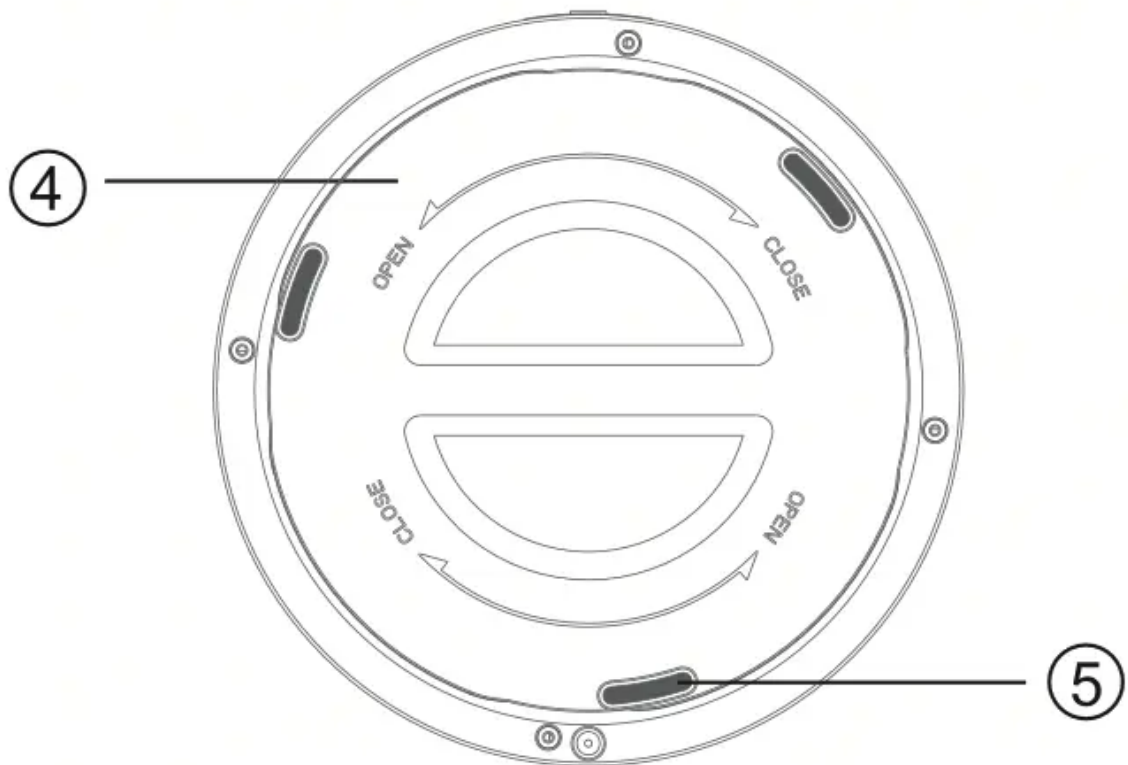

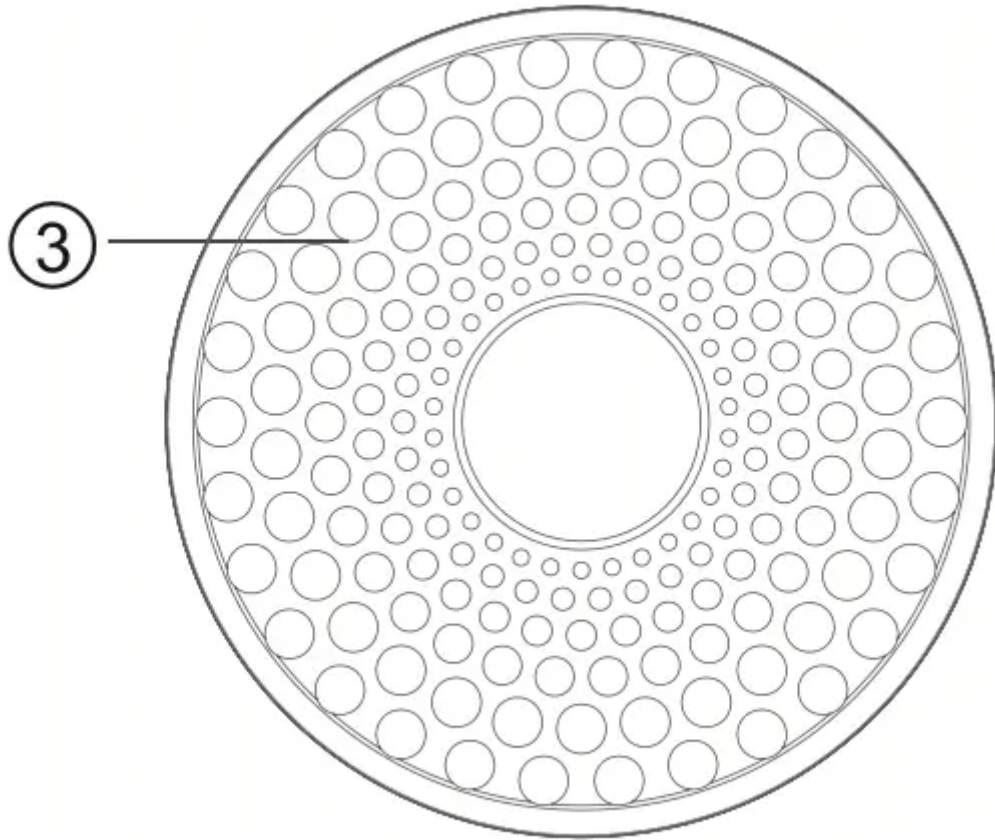

⑥

1. Metal Shell
2. Air Inlet
3. Air Outlet
4. Removable Base
5. Non-slip Pads
6. Multifunctional Filter

Important Notice: Please take the filter and power adapter out from the air purifier and remove the plastic wrapper outside the filter before use.

Preparation for Use

Unwrap the Package

Dismantle the 3-layer Purifying Filter

1. Flip the air purifier over.

Twist the filter cover counterclockwise and remove it.

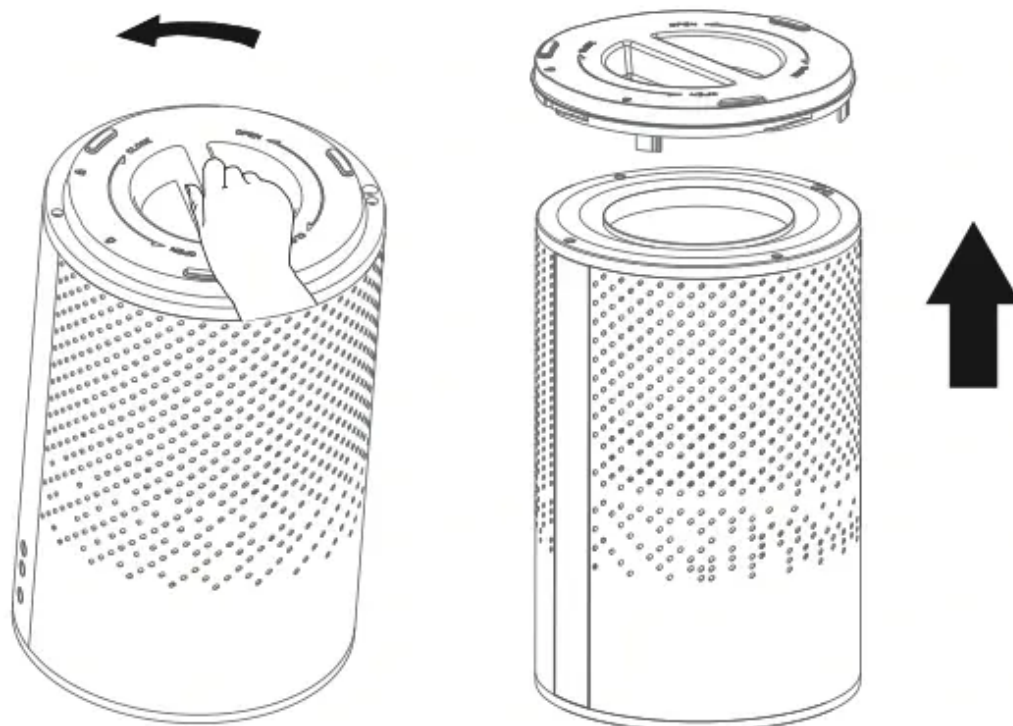

2. The filter and adapter are placed in the machine, please remove the cover to get them.

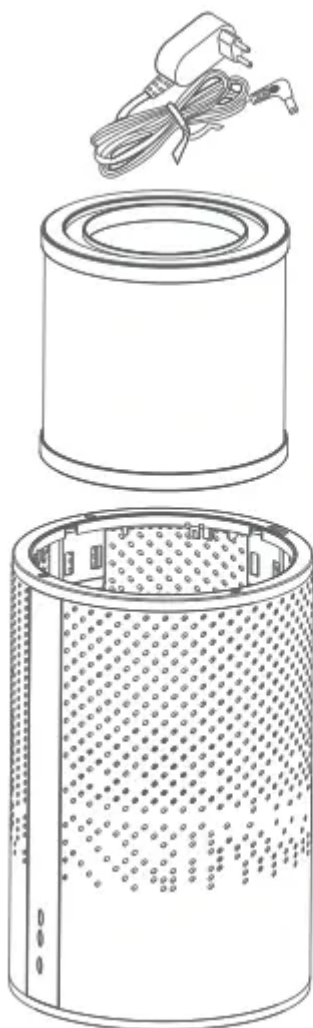

3. Remove the filter from its plastic packaging.

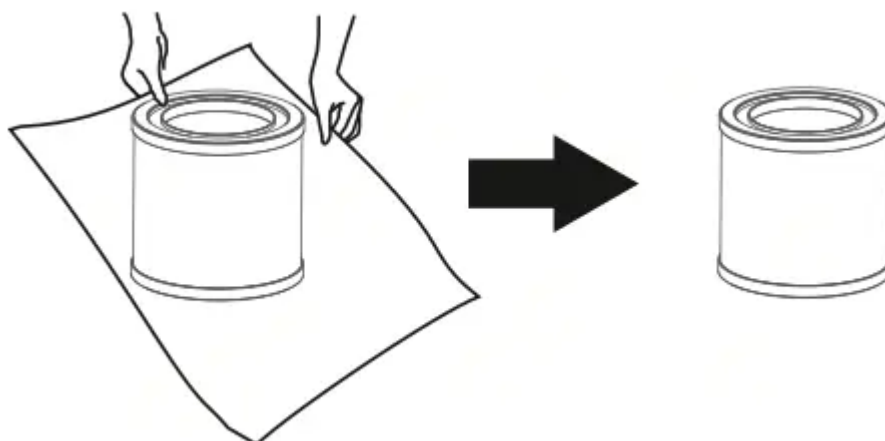

Important: Since the purifying filter is consumable, it is not applied to warranty. Please confirm that the filter is in good condition before use.

Install the 3-layer Purifying Filter

1. Place the filter back into the air purifier. (The side with drawstring should be placed outward.)

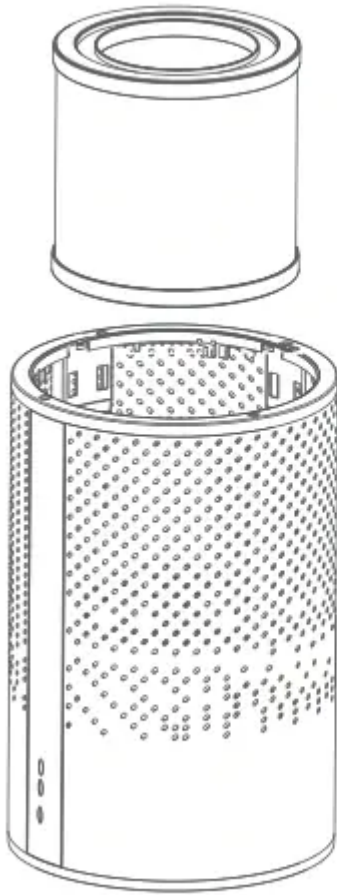

2. Replace the cover and cap. Twist the filter cover clockwise to tighten it.

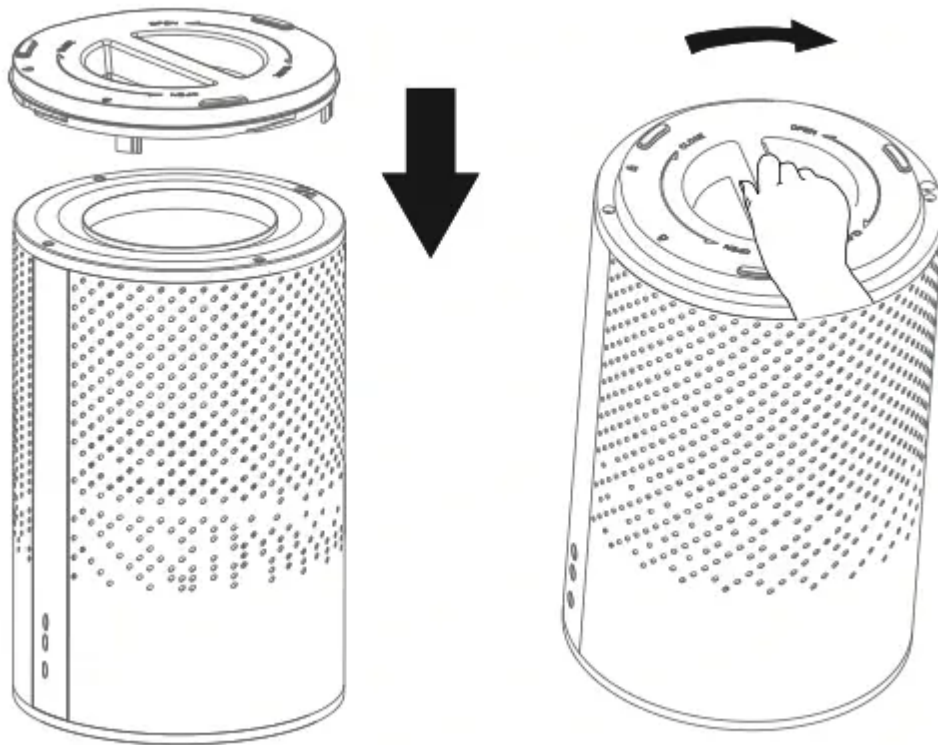

Important: Please do not use the air purifier when there is no filter installed.

Power On

Locate breeva A1 on a hard, horizontal surface and plug into outlet. Be sure that the air purifier is not blocked by other objects and there are no flames near the unit.

ONLY applicable for 100-240V, 50/60Hz power. Don't handle the plug or air purifier with wet hand. Once press the Power Button, you will hear a prompt "Beep" sound.

Please keep doors and windows closed during use. Under extreme environment, if the air quality is not improved after long time operation of the air purifier, please open door and window to keep air ventilation. For better air circulation work of breeva A1, allow at least 30cm of clearance on all sides of the purifier and 100cm of clearance on top of it.

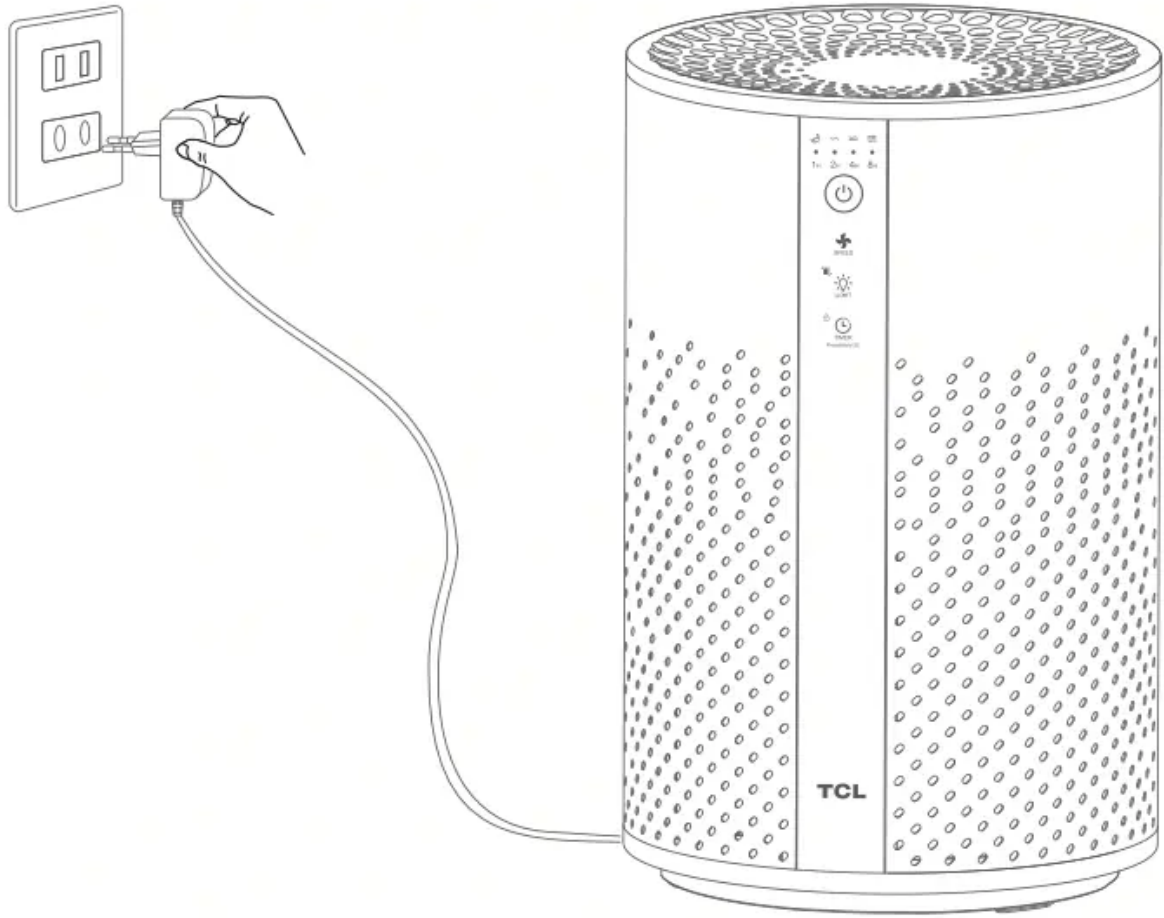

Control Panel

Control Panel of TCL breeze A1

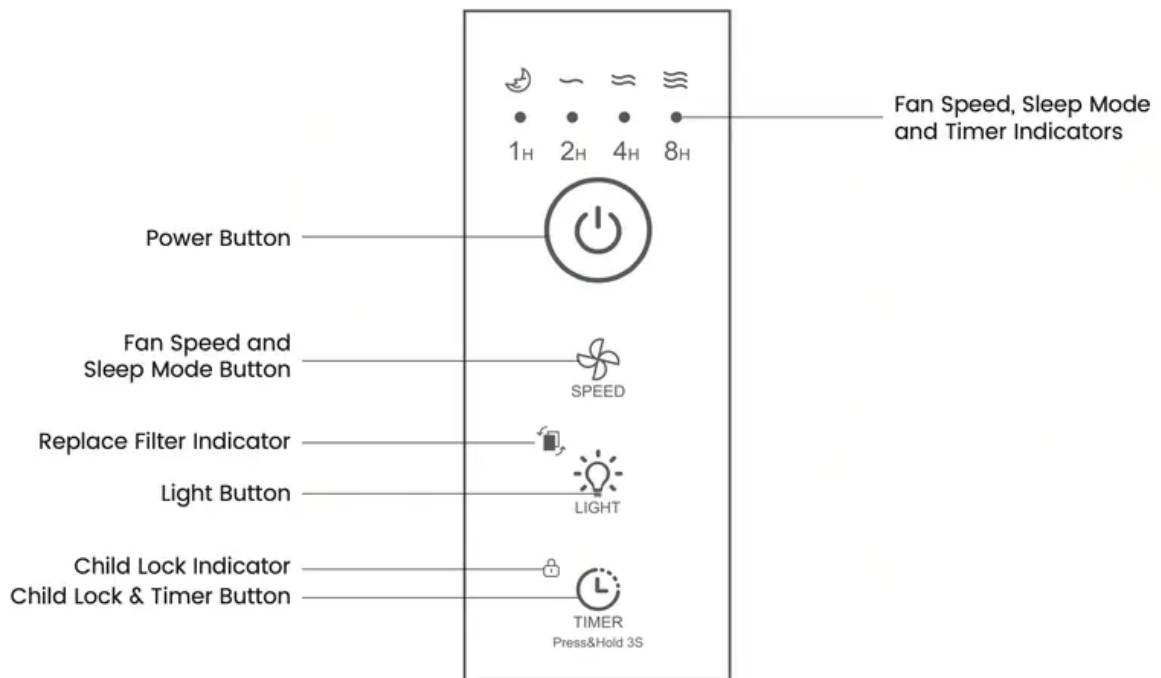

How to Use

Start-up

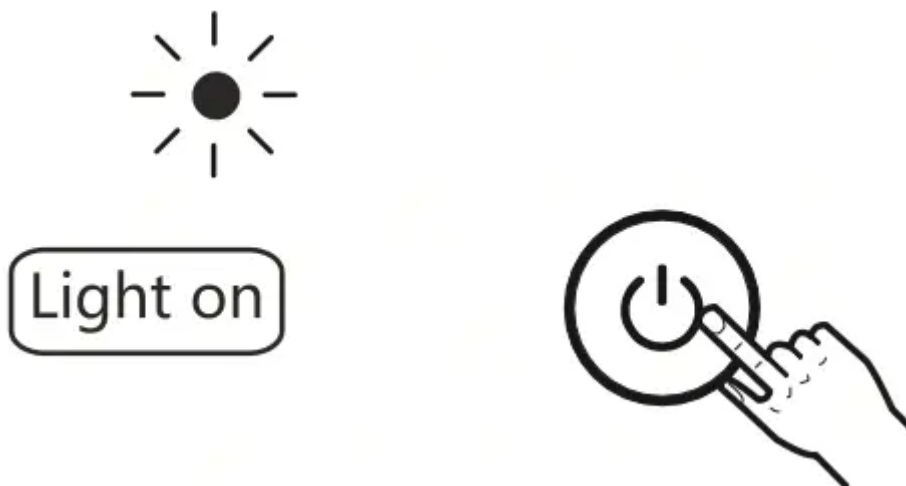

- Plug into standard electrical outlet and press the Power Button.
- Fan Speed Indicator "Low" lights up when the power button is turned on.
- When the "Child Lock" is set, the Power Button will fail to work except the lock is canceled.

Fan Speed



- Press the Fan Speed Button to switch the speed as you want.
- There are 4 fan speeds for you, ☾ (sleep), ~ (low), ≈ (medium), ≡ (high).
- When you choose Sleep Mode, other indicators on the panel will be off.

Light



- Press the Light Button to turn on and off the ambient colorful light.
- You may change the color of the light through pressing the Light Button again.

Timing

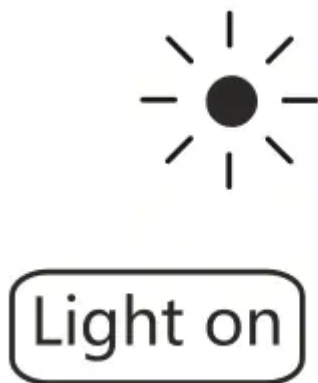

- Press the Timer Button to start up and shut down the timing function. You can set a timer for 1, 2, 4 and 8 hours.
- Tap the Timer Button repeatedly to select a time.
- To cancel a timer, tap the Timer Button until all timer indicators are off. If you press the Power Button after the timing is set, timing set before will be canceled.

Child Lock





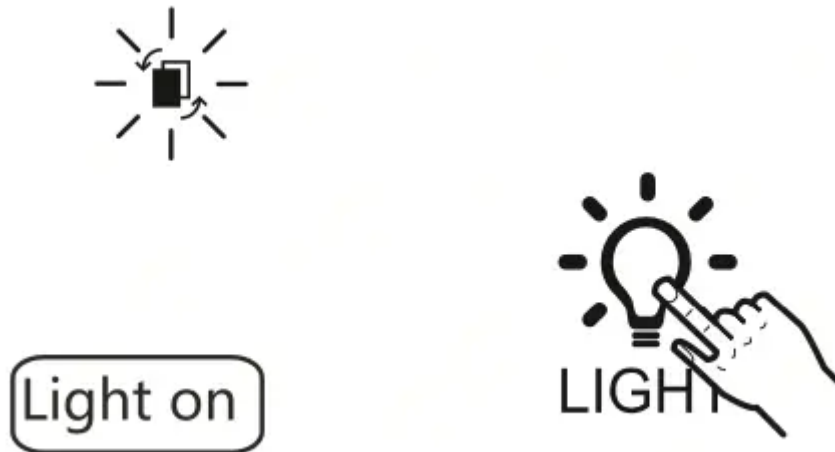

- Press the Timer Button and hold for 3 seconds to turn on/off the Child Lock function. When the Child Lock is on, all other buttons on the panel are unavailable.

Multifunctional Filter Reset



- There is internal timer computing the working time of Multifunctional Filter. When the Replace Filter Indicator turns yellow, it reminds user that the Filter is about to expire while the Indicator turns red, there will also be a buzzer reminding user of replacing a new filter.
- After replacing a new filter, please press Light Button and hold at least 3 seconds until the Replace Filter Indicator lights off to restart the internal timer so as to re-compute working time of the new filter.

What's in the Box

TCL breeva AI	Packing List				Remarks
Item	Air Purifier 	3-Layer Purifying Filter 	Adapter 	Manuel 	Flip the air purifier over. Twist the filter cover counterclockwise and remove it. The filter and adapter are placed in the machine, please remove the cover to get them. Remove the filter from its plastic packaging and place the filter back into the purifier with the handle facing up.
Quantity	1	1	1	1	

Maintenance

Maintenance Precautions

- The power plug must be unplugged and power connection must be disconnected before maintenance.

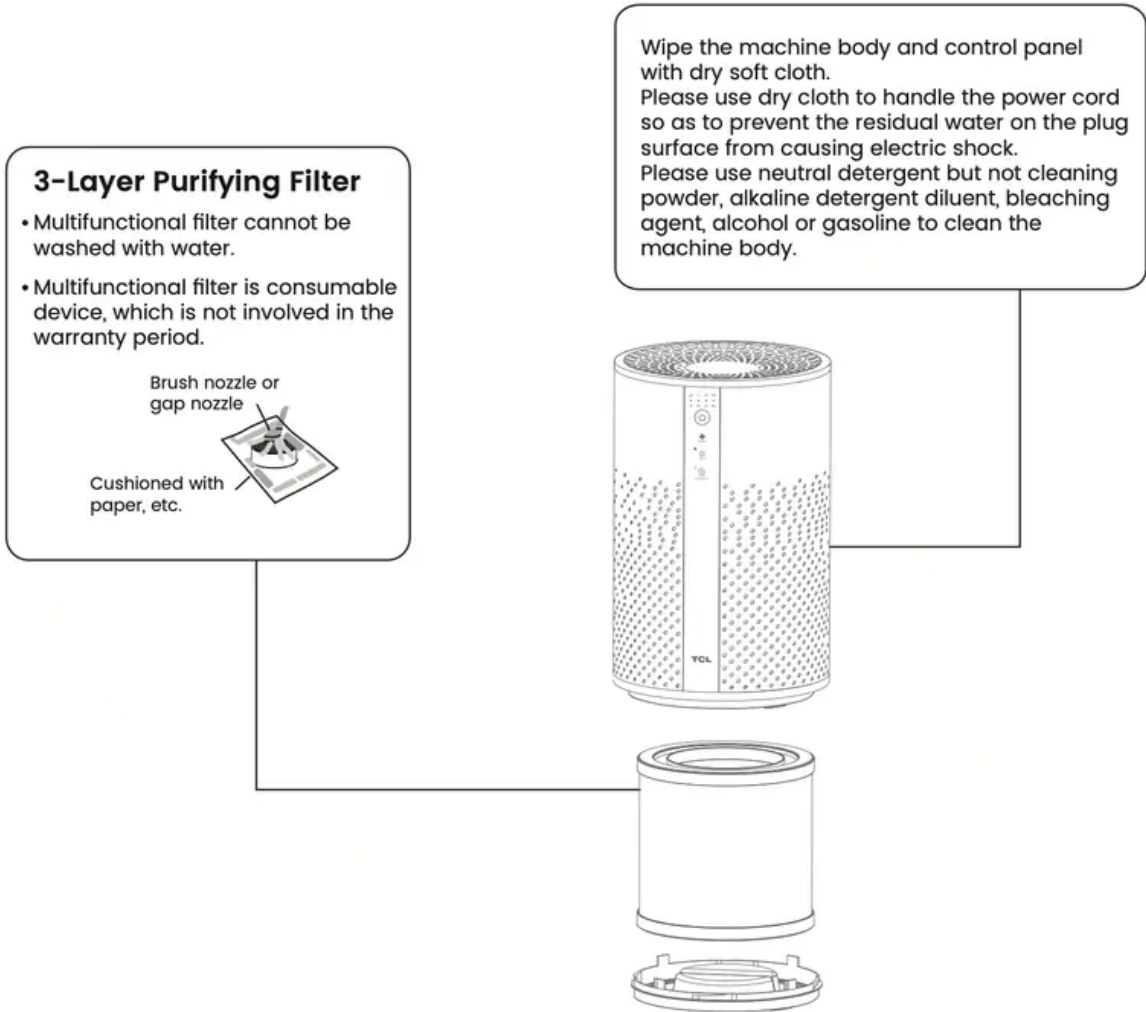

Notes: Please do not operate while dismantling the multifunctional filter.(It will lose the effect of dust removal and the absorbed dust may cause the sensor fault.)

REFERENCE TIME of REPLACING MULTIFUNCTIONAL FILTER	
Multifunctional Filter	When the Replace Filter Indicator is on. (about once every 3 to 6 months.)
Condition: The product keeps working 8 hrs/day and operating environment is ordinary.	
If the operating environment is heavily polluted, please shorten the replace time according to practical situation.	

- The replacement frequency of multifunctional filter may vary, depending on actual use and operating environment. Please replace the filter when purification is not effective.



- After replacing a new filter, tap on the Light Button and hold 3 seconds until the Replace Filter Indicator is off.
- Please handel the used multifunctional filter as non combustible rubbish.

Troubleshooting

The problems that you may encounter when using the machine are listed below. If you are unable to solve the problem according to following information, please contact Customer Support.

Problems	Possible Solution
The filter indicator flashes for a long time	You have neglected the prompt of replacing strainer. When the Replace Filter Indicator starts flickering, you are supposed to replace the filter timely in case of affecting the purifying efficiency. After replacing the filter, please follow the reset step and the indicator will be off.
There is no air from air outlet	Plug in the air purifier. Check to see if the power cord is damaged, if so, please contact Customer Support. Plug into a different outlet.
Poor air purifying performance	Tap Fan Speed Button to increase fan speed. Make sure no objects are blocking the sides or top of the air purifier (the inlet or outlet). Make sure the filter is removed from its packaging and properly in place. Close doors and windows while using the air purifier. Make sure the room is smaller than 161 ft ² (15m ²). The air purifier may not be as effective in larger rooms. Replace the filter.
There is dirt in the air which is hard to remove	Please check whether the filter is dirty. If is still no improved after maintenance, please replace the filter.
The smell in the air is hard to remove	If the air purifier is used in environment with cigarette, roast and other strong smells, it will generate odor in several weeks or months, please replace the filter and open window and door to keep ventilating frequently.

Warning

This content is compiled from multiple sources and is provided for reference purposes only. It may not be complete or fully applicable to all situations. If you are unable to resolve your issue, please contact the product manufacturer or an authorized service provider for official support.

Document generated by [ManualsFile](#)