

## About EyeSight

### Instrument panel display layout

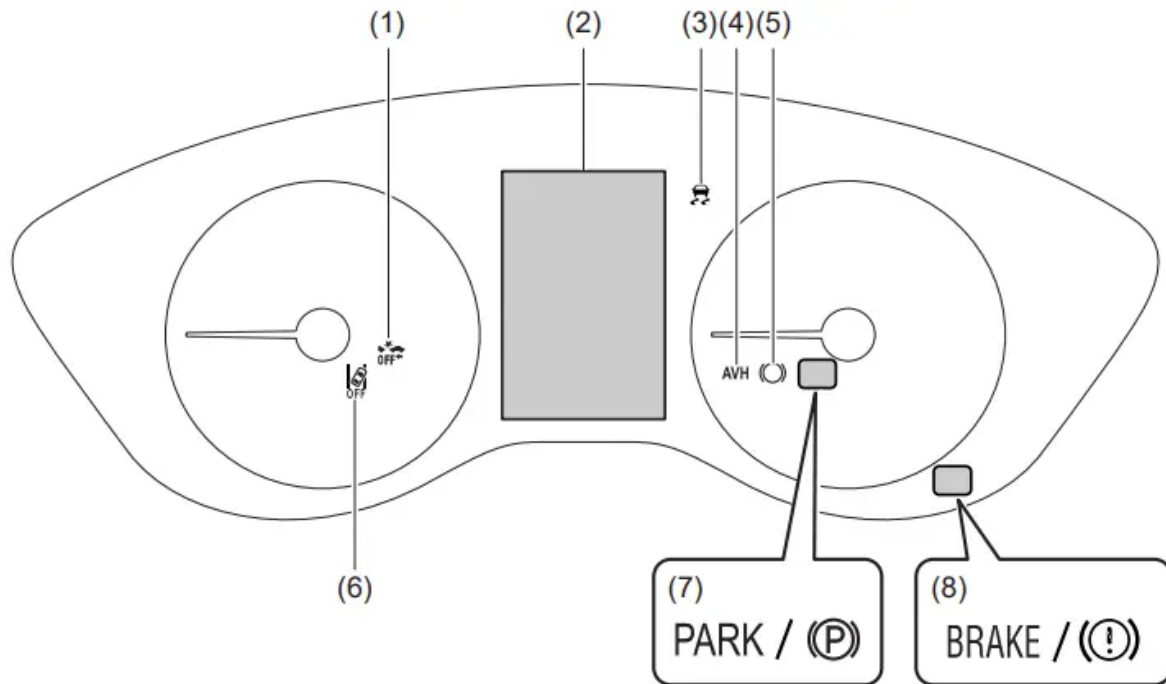

S03537

- (1) Pre-Collision Braking System OFF indicator light
- (2) Combination meter display
- (3) Vehicle Dynamics Control warning light
- (4) Auto Vehicle Hold ON indicator light
- (5) Auto Vehicle Hold operation indicator light
- (6) Lane Departure Warning OFF indicator light
- (7) Electronic parking brake indicator light
- (8) Brake system warning light

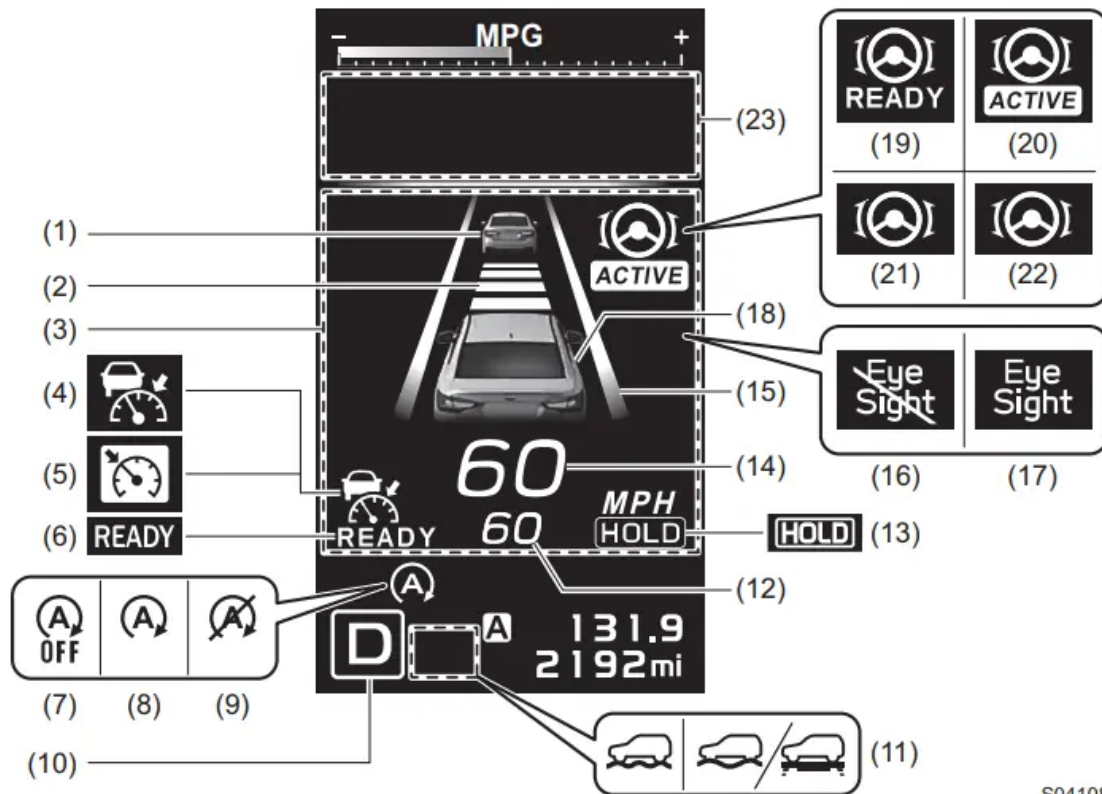

S04108

Display units can be changed in the Screen Settings. For details, refer to the Owner's Manual for your vehicle.

- (1) Lead vehicle indicator
- (2) Following distance setting indicator
- (3) EyeSight display area
- (4) Adaptive Cruise Control indicator
- (5) Conventional Cruise Control indicator
- (6) READY indicator
- (7) Auto Start Stop OFF indicator
- (8) Auto Start Stop indicator (green)/Auto Start Stop warning indicator (yellow)
- (9) Auto Start Stop No Activity Detected indicator light
- (10) Select lever/gear position indicator
- (11) X-MODE indicator (if equipped)
- (12) Set vehicle speed
- (13) HOLD indicator
- (14) Current vehicle speed
- (15) Lane indicator
- (16) EyeSight temporary stop indicator (white)



- (17) EyeSight warning indicator (yellow)
- (18) Your vehicle indicator
- (19) Lane Centering indicator (white) (For US models)
- (20) Lane Centering indicator (green) (For US models)
- (21) Lane Centering indicator (white) (For Canada models)
- (22) Lane Centering indicator (green) (For Canada models)
- (23) Warning screen area





#### Adaptive Cruise Control indicator

- This indicator illuminates when the  (CRUISE) switch is pressed.
- When Adaptive Cruise Control is activated, this indicator changes from white to green. When the driver accelerates the vehicle by depressing the accelerator pedal while Adaptive Cruise Control is operating, the indicator changes from green to white.

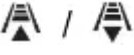

#### Conventional Cruise Control indicator

- This indicator illuminates when the  /  (Following distance setting) switch is pressed and held after pressing the  (CRUISE) switch.
- This indicator changes from white to green when Conventional Cruise

Control is activated.



#### READY indicator

**READY** illuminates when cruise control\* can be activated.

Adaptive Cruise Control and Conventional Cruise Control



#### HOLD indicator

**HOLD** illuminates when the stay-stopped function is operated while Adaptive Cruise Control is on.





### Lead vehicle indicator

When Adaptive Cruise Control is activated or when the stay-stopped function is engaged, this indicator illuminates when a vehicle in front has been detected.



### Following distance setting indicator

Indicates the following distance setting that was set with the  /  (Following distance setting) switch.



### Set vehicle speed

- Displays the set vehicle speed.
- This indicator changes from white to green when Adaptive Cruise Control or Conventional Cruise Control is activated.



### Select lever/gear position indicator

This indicator illuminates and shows which position the select lever or the gear is in.





### EyeSight warning indicator (yellow)

- This indicator illuminates or flashes when a malfunction occurs in the EyeSight system.
- When it is illuminated or flashing, none of the EyeSight functions can be used (including Adaptive Cruise Control and Pre-Collision Braking System, etc.).



### EyeSight temporary stop indicator (white)

- This indicator illuminates when the EyeSight system is temporarily stopped.
- When the ignition switch is placed in the ON position, this indicator will illuminate if the  (CRUISE) switch or the  (Lane Centering) switch is set to ON within approximately 7 seconds of the engine starting. It turns off when approximately 7 seconds have elapsed since the engine started.

- When it is illuminated, none of the EyeSight functions can be used except for Conventional Cruise Control.



**Auto Start Stop indicator (green) (also used as Auto Start Stop warning indicator (yellow))**

- This indicator illuminates in yellow when the ignition switch is turned to the ON position, and then it turns off after the engine starts.
- It illuminates in green while the Auto Start Stop system operates. It turns off after the engine restarts.
- It illuminates in yellow if a malfunction occurs in the Auto Start Stop system.



**Auto Start Stop OFF indicator**

This indicator illuminates when the Auto Start Stop system is turned off. It turns off when the Auto Start Stop system is turned on.

- Refer to the vehicle Owner's Manual for details.



**Auto Start Stop No Activity Detected indicator light**

When a vehicle is stopped, the indicator light illuminates when the operating conditions of the Auto Start Stop system are not met. The light will turn off when the vehicle starts driving.



**X-MODE indicator (if equipped)**

This indicator illuminates when the X-MODE is on.

- Refer to the vehicle Owner's Manual for details.



**Lane Departure Warning OFF indicator light**

- This indicator light illuminates when Lane Departure Warning and Lane Sway Warning are off.
- It also illuminates when the ignition switch is turned to the ON position. Approximately 7 seconds after the engine starts, the Lane Departure Warning OFF indicator light will turn off or remain illuminated depending on the current status (ON or OFF).



### Pre-Collision Braking System OFF indicator light

- This indicator light illuminates when Pre-Collision Braking System and Pre-Collision Throttle Management are off.
- It also illuminates when the ignition switch is turned to the ON position, and then turns off approximately 7 seconds after the engine starts.



### Lane indicator

- This indicator illuminates in gray when Lane Departure Prevention Function is turned on.
- It illuminates in white under the following conditions.
  - Lane Departure Prevention Function goes into the standby status.
  - Lane Centering Function is operating by detecting the lane markings.
- It illuminates in yellow when Lane Departure Prevention Function is operating.



### Brake system warning light

If the brake system warning light illuminates when the electronic parking brake is released while driving, turn Pre-Collision Braking System off. At this time, do not use Adaptive Cruise Control or Conventional Cruise Control.

If the brake system warning light does not turn off, immediately pull the vehicle over in a safe place. Contact a SUBARU dealer to have the system inspected.

- Refer to the vehicle Owner's Manual for details.



### Electronic parking brake indicator light

This indicator light illuminates when the electronic parking brake is applied.

- Refer to the vehicle Owner's Manual for details.



### Your vehicle indicator

When the brake pedal is depressed or the brake control function is activated, the brake lights on the vehicle indicator illuminate in red.



### Lane Centering indicator

- This indicator illuminates when Lane Centering Function is turned on by pressing the  (Lane Centering) switch (only when Adaptive Cruise Control is on).
- This indicator turns off when Adaptive Cruise Control is off.
- While Lane Centering Functions is operating, the indicator changes from white to green.



### Vehicle Dynamics Control warning light

This warning light illuminates when the ignition switch is turned to the ON position, and turns off approximately 2 seconds after the engine is started. It will illuminate if there is a malfunction in the Vehicle Dynamics Control electrical control system.

- Refer to the vehicle Owner's Manual for details.

## AVH Auto Vehicle Hold ON indicator light

This indicator light illuminates when the Auto Vehicle Hold is activated.

- Refer to the vehicle Owner's Manual for details.



### Auto Vehicle Hold operation indicator light

This indicator light illuminates while the vehicle is stopped by the Auto Vehicle Hold function.

- Refer to the vehicle Owner's Manual for details

## Switch layout

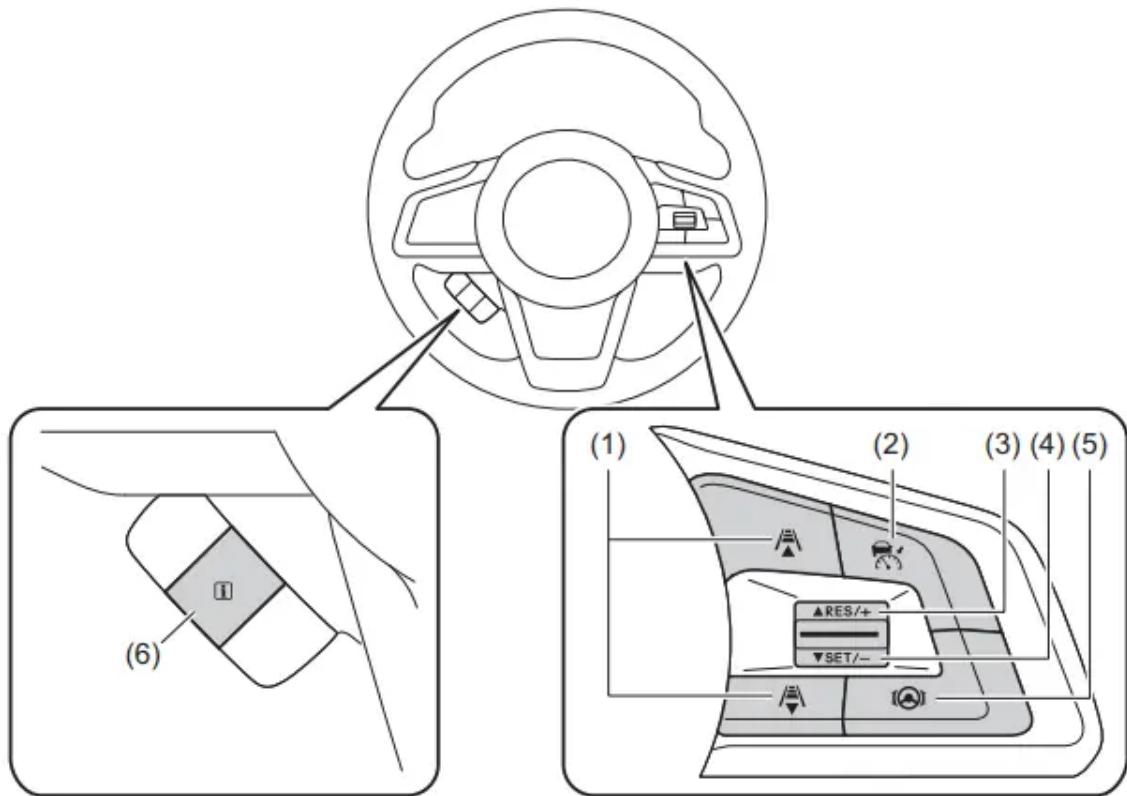

S03969

- |  |                              |
|--|------------------------------|
| (1)  (Following distance setting) switches | (4) SET/- switch             |
| (2)  (CRUISE) switch                       | (5)  (Lane Centering) switch |
| (3) RES/+ switch                           | (6)  switch                  |

### (CRUISE) switch

- Press this switch to turn cruise control\* on/off.
- When the (CRUISE) switch is pressed, (Adaptive Cruise Control indicator) appears on the EyeSight display area of the combination meter display, and then (Conventional Cruise Control indicator) appears by pressing and holding the (Following distance setting) switch for approximately 2 seconds. When (Adaptive Cruise Control indicator) or (Conventional Cruise Control indicator) is shown on the EyeSight display area, this indicates that the main cruise control is on.
- Press this switch to cancel the cruise control.

\*Adaptive Cruise Control and Conventional Cruise Control

### RES/SET switch

## SET/-

- Press this switch to set cruise control\*.
- Press this switch to reduce the set vehicle speed (when cruise control\* is currently set).
  - Adaptive Cruise Control
  - Conventional Cruise Control

\*Adaptive Cruise Control and Conventional Cruise Control

## RES/+

- Press this switch to set cruise control\*.
- After cruise control\* is canceled, press this switch to resume the cruise control function at the vehicle speed that was previously set.
- Press this switch to increase set vehicle speed (when cruise control\* is currently set).
  - Adaptive Cruise Control
  - Conventional Cruise Control

\*Adaptive Cruise Control and Conventional Cruise Control

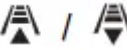

### Following distance setting) switches

- Press either of these switches to select the set following distance in 4 stages (only when Adaptive Cruise Control is on).
- When the  (CRUISE) switch is on, switching between Adaptive Cruise Control and Conventional Cruise Control is possible by pressing the  (Following distance setting) switch\*.

\*:To switch to Conventional Cruise Control, press and hold the switch for approximately 2 seconds or longer.



### (Lane Centering) switch

- Press this switch to turn Lane Centering Function on/off (only when Adaptive Cruise Control is on).
  - When Lane Centering Function status is standby, (Lane Centering indicator) (white) illuminates.
  - When Lane Centering Function status is active, (Lane Centering indicator) (green) illuminates.



### switch

Pull this switch to display the message that appeared in the warning screen area again.

## Center information display



- (1) Pre-Collision Braking System indicator
- (2) Lane Departure Warning indicator
- (3) EyeSight Assist Monitor

The settings of the on-board systems can be changed by operating the center information display.

Warning screens will be displayed on the center information display as needed.

- Pre-Collision Braking System indicator

This indicator illuminates when Pre-Collision Braking System and Pre-Collision Throttle Management are on.

- Lane Departure Warning indicator

This indicator illuminates when Lane Departure Warning and Lane Sway Warning are on.

- EyeSight Assist Monitor

This indicator illuminates when EyeSight Assist Monitor is on.

## Changing settings

The EyeSight settings can be changed by operating the center information display.

The following systems can also be turned on/off by operating the center information display.

- Vehicle Dynamics Control
- X-MODE (if equipped)
- Auto Vehicle Hold (AVH)
  - Refer to the vehicle Owner's Manual for details.

## Warning screens

The following warning screens will be displayed on the center information display

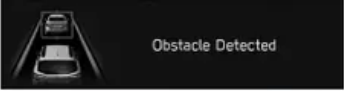
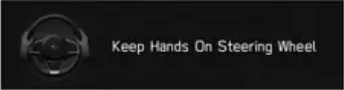
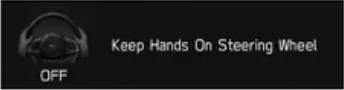

Item	Displayed screen
Pre-Collision Braking System warning (first braking and secondary braking)	 S03539
"Obstacle Detected" warning	
Lane Centering Function warning (no-operation of the steering wheel)	 S03540
Lane Centering Function cancellation (no-operation of the steering wheel)	 S03541

## Conventional Cruise Control

Conventional Cruise Control is a driving support system intended to allow more comfortable driving on expressways, freeways and interstate highways. It can be used to travel at a constant speed by maintaining the vehicle speed set by the driver. Please remember that you should not exceed posted speed limits.

### How to use Conventional Cruise Control

#### Setting Conventional Cruise Control

(1) Setting Adaptive Cruise Control to standby status Press the  (CRUISE) switch. At this time,  (Adaptive Cruise Control indicator) (white) and the following distance setting indicator are displayed on the EyeSight display area of the combination meter display. The set vehicle speed display will read "-- MPH (- - - km/h)".

When the  (CRUISE) switch is pressed, the initial cruise control mode is always Adaptive Cruise Control.

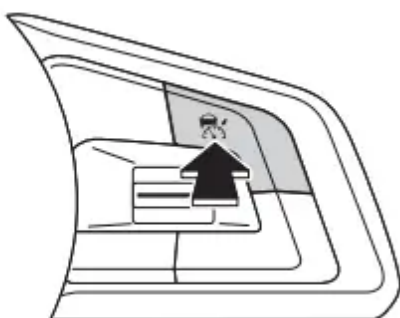

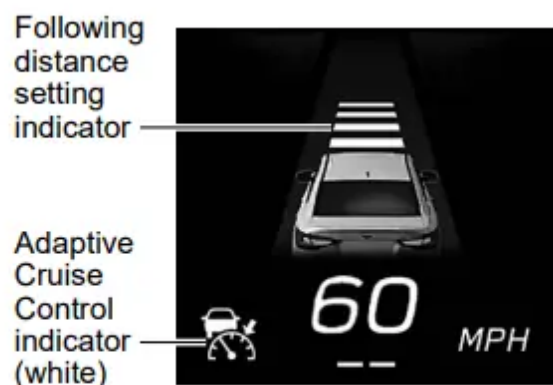

S03393



S03414

(2) Switch to Conventional Cruise Control.

Press and hold the  /  (Following distance setting) switch for approximately 2 seconds or longer to switch from Adaptive Cruise Control to Conventional Cruise Control. A notification sounds 1 short beep.

At this time, the following distance setting indicator on the EyeSight display area of the combination meter display turns off and  (Conventional Cruise Control indicator) (white) is displayed.

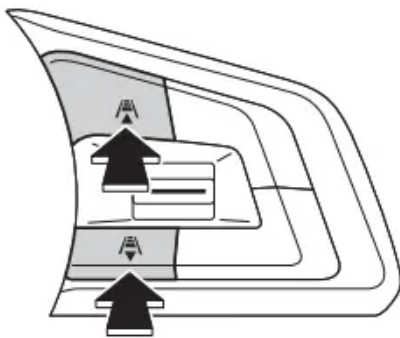

S03397

Conventional Cruise Control indicator (white)



S03431

To set the ready status:

Conventional Cruise Control can be activated when all of the following conditions are met and **READY** (READY indicator) is displayed on the EyeSight display area.

- All doors (except the rear gate/trunk) are closed.
- The driver's seatbelt is fastened.
- The electronic parking brake is not engaged. The electronic parking brake indicator light is turned off.
- The select lever is in the "D" or "M" position.
- The brake pedal is not depressed.
- The road is not on a steep slope.
- The steering wheel has not been turned significantly in either direction.
- The X-MODE is not turned on (the X-MODE indicator goes off). (if equipped)
- The vehicle speed is between approximately 20 mph (30 km/h) and 90 mph (145 km/h).

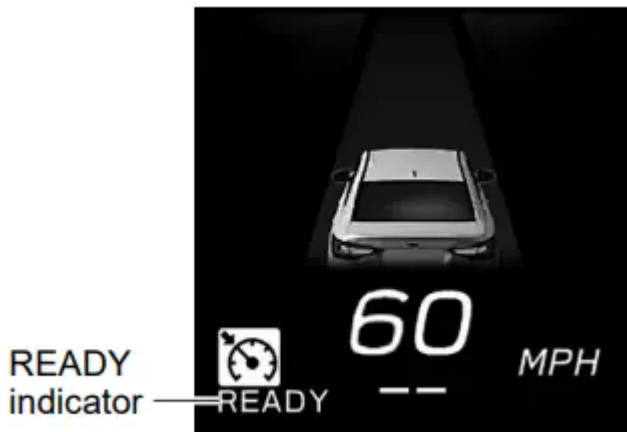

S03432

(3) Control the accelerator pedal to reach the desired speed.

(4) When the vehicle reaches the desired speed, press the RES/SET switch to the “RES/+” side or the “SET/-” side. The vehicle speed at the time when the switch is pressed will become the set vehicle speed, and constant speed driving will initiate.

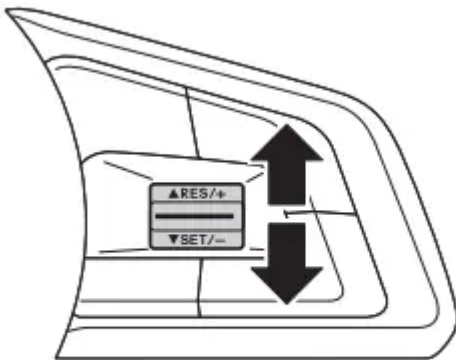

S03394

When Conventional Cruise Control is activated, **READY** (READY indicator) turns off, the set vehicle speed is displayed and  (Conventional Cruise Control indicator) changes from white to green.



S03433

### Increasing the set vehicle speed

Using the RES/SET switch

- Push to the “RES/+” side briefly. Every time the switch is pushed, the set vehicle speed will increase to the next 5 mph (5 km/h) increment.
- Push to the “RES/+” side continuously. While the switch is being pushed, the set vehicle speed will increase in increments of 1 mph (1 km/h).

When operating the switch, the set vehicle speed changes on the combination meter display.

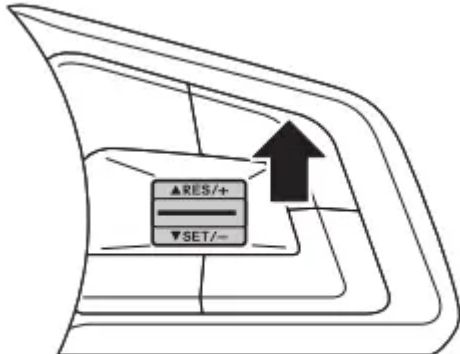

S03395

Using the accelerator pedal

1. Depress the accelerator pedal to increase vehicle speed.
2. When the desired speed is reached, press the RES/SET switch to the “SET/-” side. The speed at the time of pressing the switch will be set as the new set vehicle speed, and it appears on the EyeSight display area

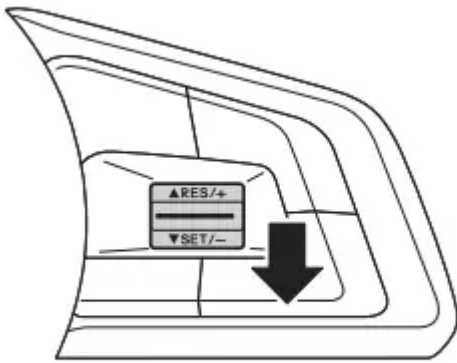

S03396

### Decreasing the set vehicle speed

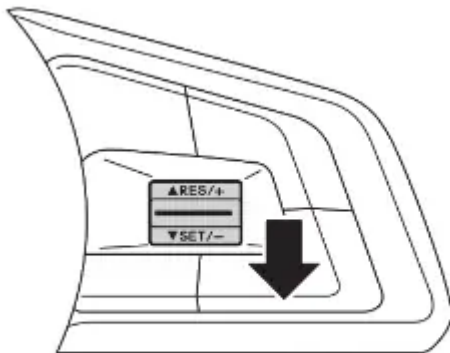

S03396

#### Using the RES/SET switch

Push to the “SET/-” side briefly.

Every time the switch is pushed, the set vehicle speed will decrease to the next 5 mph (5 km/h) decrement.

Push to the “SET/-” side continuously.

While the switch is being pushed, the set vehicle speed will decrease in decrements of 1 mph (1 km/h).

When operating the switch, the set vehicle speed changes on the combination meter display.

#### Using the brake pedal

1. Depress the brake pedal to decrease the vehicle speed. Conventional Cruise Control will be canceled and  (Conventional Cruise Control indicator) changes from green to white.
2. When the desired speed is reached, press the RES/SET switch to the “SET/-” side.

The speed at the time of pressing the switch will be set as the new set vehicle speed, and it appears on the EyeSight display area.

### Accelerating temporarily

Depress the accelerator pedal to accelerate temporarily.

When the accelerator pedal is released, the vehicle returns to the set vehicle speed.

### Decelerating temporarily

Depress the brake pedal to decelerate temporarily. When the brake pedal is depressed, Conventional Cruise Control will be canceled. While the set vehicle speed remains displayed on

the EyeSight display area,  (Conventional Cruise Control indicator) changes from green to white. Release the brake pedal and press the RES/SET switch to the “RES/+” side to reset the set vehicle speed.



S03579

### Canceling Conventional Cruise Control

Canceling by driver operation



Any of the following operations will cancel Conventional Cruise Control.

- Depress the brake pedal.

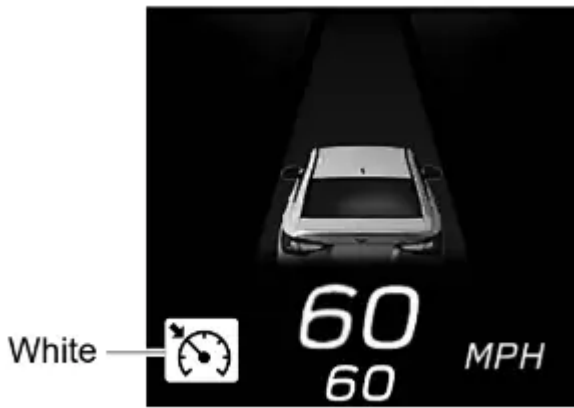
 (Conventional Cruise Control indicator) changes from green to white while the set vehicle speed remains displayed on the EyeSight display area.



S03579

- Press the  (CRUISE) switch.  (Conventional Cruise Control indicator) changes from green to white while the set vehicle speed remains displayed on the EyeSight display area.

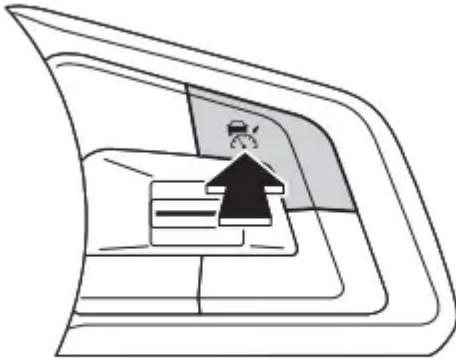

S03393

Automatic cancellation by the system In the following cases, a notification sounds 1 short beep and 1 long beep and the cruise control function is automatically canceled. (Conventional Cruise Control indicator) changes from green to white. Also, the Conventional Cruise Control cancellation message is displayed on the screen. After the conditions listed below have been resolved, perform the cruise control set operation again to reactivate cruise control.

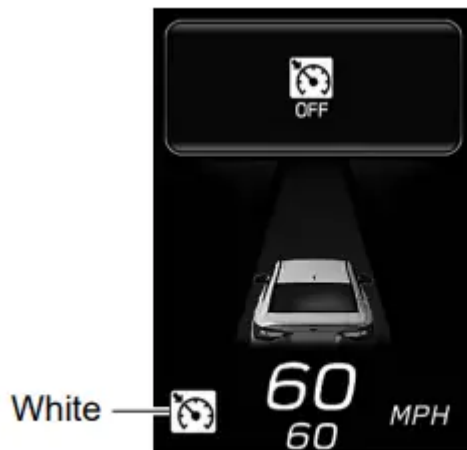

S03434

- The select lever is moved to a position other than “D” or “M”.
  - Conventional Cruise Control can be resumed after the select lever is returned to the “D” or “M” position.
- Vehicle speed drops to approximately 16 mph (25 km/h) or less (due to a steep uphill grade or some other reason).
- The X-MODE is turned on (the X-MODE indicator illuminates). (if equipped)
  - Conventional Cruise Control can be resumed after the X-MODE is turned off.
- Vehicle speed increases to approximately 100 mph (160 km/h) or more.
- The Vehicle Dynamics Control or the Traction Control Function is activated.
- Any door (except the rear gate/trunk) is opened.
- The driver’s seatbelt is unfastened.
- The electronic parking brake is engaged.
- The EyeSight system has a malfunction.  (EyeSight warning indicator: Yellow)
- The steering wheel is turned significantly in either direction.
- The grade of the road is steep.
- The Pre-Collision secondary braking is activated

### Restoring the previously set vehicle speed

The previously set vehicle speed is stored in memory. To restore that vehicle speed, press the RES/SET switch to the “RES/+” side.  (Conventional Cruise Control indicator) changes from white to green. You can restore the set vehicle speed when the previously set vehicle speed has been stored and the current vehicle speed is approximately 20 mph (30 km/h) or more.

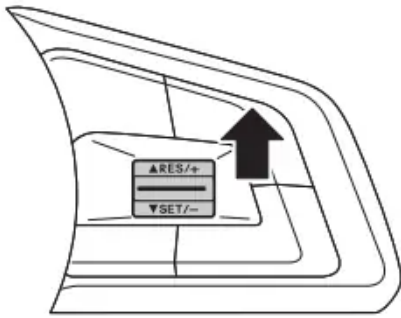



S03395



S03433

## Turning off Conventional Cruise Control



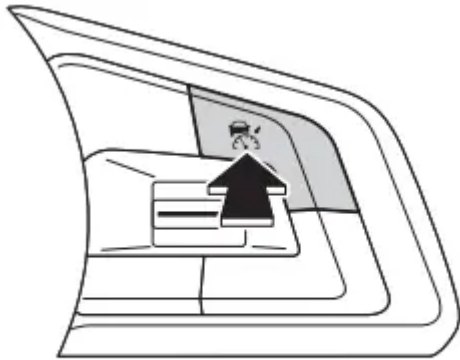

When Conventional Cruise Control is not active, press the  (CRUISE) switch.  (Conventional Cruise Control indicator) turns off on the EyeSight display area.



S03393

## Troubleshooting

### Adaptive Cruise Control cannot be activated.

- Did you remember to press the  (CRUISE) switch?
  - If you have not pressed the  (CRUISE) switch,  (Adaptive Cruise Control indicator) will not be shown.
- Is EyeSight operation temporarily stopped?
  - When EyeSight is temporarily stopped,  (EyeSight temporary stop indicator: White) is displayed on the combination meter display. Set Adaptive Cruise Control again after the cause for the temporary stop has been corrected.

- Is **READY** (READY indicator) displayed?
  - Adaptive Cruise Control cannot be activated when **READY** (READY indicator) is not displayed. Set Adaptive Cruise Control when **READY** (READY indicator) is displayed.

**READY (READY indicator) is not displayed.**

- Are the requirements for setting cruise control met?
  - For the conditions of **READY** (READY indicator) illumination, refer to the following pages.
    - (Adaptive Cruise Control)
    - (Conventional Cruise Control)

**A vehicle (in front of your vehicle) is not detected, detection is delayed or detection is lost quickly.**

- Is the vehicle in front stopped, moving slowly relative to your vehicle or moving extremely slowly?
  - Detection of stopped vehicles, vehicle moving slowly relative to your vehicle, and vehicles moving extremely slowly may be difficult.
- Is the windshield dirty or fogged?
  - If the windshield is dirty or fogged, it may not be possible to detect object or vehicles. Clean off the dirt or fog from the windshield, and then try using the system again.
- Is the vehicle in front far away?
  - The maximum detection distance of EyeSight's stereo camera is approximately 360 ft (110 m). Detection is not possible if the vehicle is farther away.
- Is the vehicle on a curve?
  - The detection range is limited in the horizontal directions when the stereo camera is properly aimed.
- Is the vehicle on a road with repeated uphill and downhill grades (such as an overpass), or on a banked road?
  - The detection range is limited in the vertical directions.
- Did the vehicle detected in front change?
  - Detection may be delayed after the vehicle in front has changed.

- Have water, snow or other substances been kicked up by the vehicle in front as it drives?
  - When water or snow have been kicked up, it may not be possible to detect the vehicle in front.

**Adaptive Cruise Control is activated even though there is no vehicle in front detected.**

- Is there a vehicle in the neighboring lane?
  - Depending on the road conditions, vehicles in neighboring lanes may be detected as well as a vehicle directly in front.
- Are you driving on or near a curve?
  - When driving on a curve, braking control may be activated in response to guardrails, the angle of the steering wheel, or roadside structures.

**Lead Vehicle Start Alert activates, even though there is no vehicle in front.**

- Depending on surrounding objects, traffic environment and weather, Lead Vehicle Start Alert may issue a warning in response to objects other than a vehicle that appears in front of your vehicle.

**EyeSight does not restart after a temporary stop.**

- Are you driving in the rain with poorly performing wipers or is there a smear on the windshield?
  - Replace the wipers with new ones, or clean the smear off the windshield. Are you driving in poor weather conditions with heavy rain, snow, fog, or dust?
    - In these cases, EyeSight may temporarily stop operating while visibility is very poor.
- Is your vehicle subject to sunlight from the front (sunset or sunrise, etc.) or to bright headlights from oncoming vehicles at nighttime?
  - In these cases, EyeSight may temporarily stop operating.
- Are you parking in an extremely hot or cold condition?
  - In either of these cases, EyeSight may temporarily stop operating until the temperature increases or decreases to a temperature at which the camera is operable.

**The timing of the “Obstacle Detected” warning is sometimes earlier or sometimes later than what seems to be normal operation.**

- The “Obstacle Detected” warning sounds when the system determines that more braking is necessary, based on conditions such as the distance from the vehicle in front and the difference in speed compared to it. As a result, timing may vary depending on how the

brakes are applied in relation to the vehicle in front, and your relative speed to that vehicle

**When the vehicle in front has turned off the roadway or the distance from the vehicle in front has increased, acceleration is sometimes slower or faster.**

- Depending on the timing of when the detection of the vehicle in front is lost,

EyeSight's ability to react may be slower, causing the start of acceleration to feel delayed and braking time to feel longer than what seems to be normal operation.



- What acceleration level did you select for cruise control?
  - Acceleration may vary because the cruise control characteristics vary depending on the selected mode.

**Cruise control is canceled automatically.**

- Did you perform one of the following operations?
  - (Adaptive Cruise Control)
  - (Conventional Cruise Control)
- Has the EyeSight system temporarily stopped while the Adaptive Cruise Control function was in use?

The  (Lane Centering) switch was pressed however Lane Centering Function does not activate.

- Is Adaptive Cruise Control activated?
  - Lane Centering Function activates only when Adaptive Cruise Control is activated.

 (Lane Centering indicator) does not illuminate even though the  (Lane Centering) switch is pressed.

- Is Adaptive Cruise Control turned off?
-  (Lane Centering indicator) does not illuminate when Adaptive Cruise Control is turned off

**Lane Centering Function and Lane Departure Prevention Function were unexpectedly canceled.**

- Did you take your hands off the steering wheel? Did you just lightly put your hands on the steering wheel while driving?
  - If the system does not detect the steering operation of the driver, it will temporarily cancel Lane Centering Function and Lane Departure Prevention Function.
- Did you turn a tight corner?
  - Lane Centering Function and Lane Departure Prevention Function do not operate while turning a tight corner.
- Did you perform one of the following operations?
  - (Lane Centering Function)
  - (Lane Departure Prevention Function)

**Lane Centering Function and Lane Departure Prevention Function do not operate even though there are lane markers.**

- Is the width of the road too narrow or too wide?
  - To operate Lane Centering Function and Lane Departure Prevention Function, the width of the road should be between approximately 10 ft (3 m) and 15 ft (4.5 m).

**A lead vehicle is driving ahead of my vehicle and the lead vehicle indicator is illuminated, however Lane Centering Function does not activate.**

- Is the width of the lead vehicle too narrow?
  - Lane Centering Function does not activate when the lead vehicle is a motorcycle or another 2-wheeled vehicle, super-compact car, or other narrow vehicle.
- Is there a speed difference between the lead vehicle and your vehicle? Or is the lead vehicle not directly in front of your vehicle?
  - Lane Centering Function may not activate in conditions such as when there is a speed difference between the lead vehicle and your vehicle (the lead vehicle is pulling away), or when the lead vehicle is meandering or driving at the edge of the lane.

**When Lane Centering Function is active, the interruption screen “Keep Hands On Steering Wheel” appears on the combination meter display in spite of gripping the steering wheel.**

- The system may not be detecting any steering operation even though you are gripping the steering wheel. Operate the steering wheel until the interruption screen disappears. If

the system continues to not detect any operation, Lane Centering Function may be canceled.

- If the vehicle is likely to depart the lane when Lane Centering Function is active, “Keep Hands On Steering Wheel” will be displayed. If Lane Centering Function is canceled in this state, “OFF” will be displayed.

**A noise occurs when automatic braking control activates.**

- This is the sound of the automatic braking control operating - there are some mechanical components to the system, and they do occasionally make audible sounds during automatic braking control. This does not indicate a malfunction.

**Braking control activates frequently when driving with Adaptive Cruise Control in heavy traffic.**

- When Adaptive Cruise Control is activated, the EyeSight system performs control based on the movement of vehicles or objects in front. As a result, acceleration and deceleration may be more frequent while the system adjusts to vehicles or objects the camera system is detecting. If it is difficult to maintain a consistent following distance under certain conditions (such as in heavy traffic, poor weather or urban environments, etc.), do not use Adaptive Cruise Control.

**The electronic parking brake is applied automatically while the stay-stopped function is operating.**

- The electronic parking brake will be applied in the following cases.
  - The stay-stopped function is continuously applied for approximately 2 minutes.
  - Automatic cancel conditions have been met.

**The engine is stopped while the stay-stopped function of Adaptive Cruise Control engages.**

- Does the Auto Start Stop indicator (green) illuminate?
  - This engine stop occurs as a result of the operation of the Auto Start Stop system. It does not indicate a malfunction.

**The Auto Start Stop system does not stop the engine while the stay-stopped function of Adaptive Cruise Control is engaged.**

- For information about the operation conditions of the Auto Start Stop system, refer to the Owner’s Manual for your vehicle.

**The engine does not restart after it has been automatically stopped while the stay stopped function of Adaptive Cruise Control has been engaged.**

- Does the Auto Start Stop warning indicator illuminate?
  - If the warning indicator illuminates, shift the select lever to the “P” position and start the engine with the brake pedal depressed.



- If the warning light does not turn off after the engine starts, immediately contact a SUBARU dealer to have the system inspected.

**Warning**

This content is compiled from multiple sources and is provided for reference purposes only. It may not be complete or fully applicable to all situations. If you are unable to resolve your issue, please contact the product manufacturer or an authorized service provider for official support.

---

Document generated by [ManualsFile](#)

