

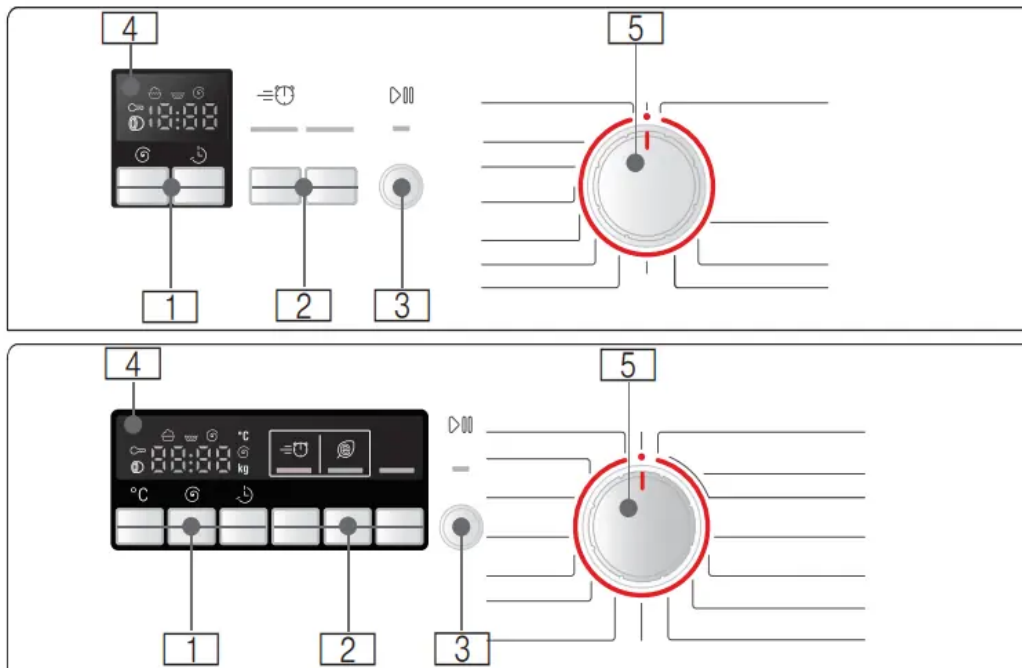

CONTROL PANEL



1. **Programme default settings** can be changed.
2. **Additional programme settings** can be selected.
3. Start/Reload for starting, interrupting (f.e. adding/removing laundry) and cancelling a programme
4. **Display panel** for settings and information
5. **Programme selector** for selecting a programme and for switching the machine on and off

Display panel

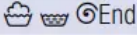
Settings for the selected programme		
Cold* - 90 °C	Temperature	in °C; Cold = cold
-- ...1200**	Spin speed; ** max. speed depends on the model	In rpm (rotations per minute); - - - = Rinse hold (without final spin)
1:30	Programme duration	Depends on the programme selection in h:min (hours:minutes)
1 - 24 h	Ready in	Programmes ends after ... h (h = hours)
7.0 kg	Max. load	

Status indicators for the programme progress (programme sequence):	
	Wash, rinse, spin, programme duration or end
	Open the washing machine door, add laundry
	Childproof lock
* depending on the model	

LAUNDRY

Prepare the laundry

Caution! Damage to the appliance/fabrics

Foreign objects (e.g. coins, paper-clips, needles, nails) may damage the laundry or components in the washing machine.

Therefore, note the following tips when preparing your laundry:

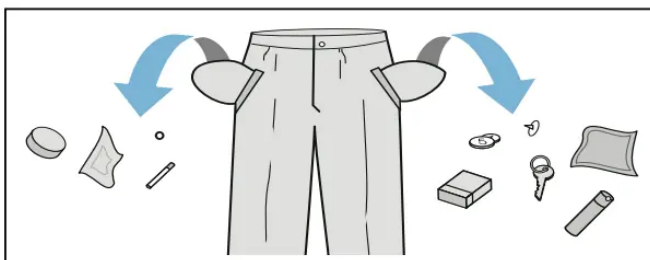

- Empty pockets.
- Look out for metal items (paperclips, etc.) and remove them.
- Wash delicates in a laundry bag (tights, underwired bras, etc.).
- Close any zips, button up any cover buttons.
- Brush sand out of pockets and collars.
- Remove curtain fittings or place curtains in a laundry bag.

Sorting laundry

Sort your laundry according to the care instructions and manufacturer's information on the care labels:





- Type of fabric/fibre
- Colour

Note: Laundry can discolour or not be cleaned correctly. Wash white and coloured laundry separately. Wash new bright fabrics separately the first time you wash them.

- Soiling: Wash laundry with the same level of soiling together. You can find examples of levels of soiling on 
 - Light: Do not prewash, select the SpeedPerfect setting if necessary
 - Normal
 - Heavy: Load less laundry, select a programme with prewash
 - Stains: Remove/pretreat stains while they are fresh. First, dab the stain with soapy water/do not rub. Then wash the items of laundry with the appropriate programme. Stubborn/dried-in stains can sometimes only be removed with several washes.
- Symbols on the care labels: The numbers in the symbols indicate the maximum washing temperature which may be used.



: Suitable for a normal washing process; e.g. **Cottons** programme

- : A gentle washing process is required; e.g. **Easy-Care** programme
- : An especially gentle washing process is required; e.g. **Delicate/Silk** programme
- : Suitable for washing by hand; e.g. **Wool** programme
- : Do not wash the laundry in the machine.

Starching

Note: Laundry must not be treated with fabric softener.

Starching is possible in all wash programmes if liquid starch is used. Starching with liquid starch is possible in programs such as Rinse and Cottons

Dyeing/bleaching

Dye should only be used in normal household quantities. Salt may damage stainless steel. Always follow the dye manufacturer's instructions.

Do **not** use the washing machine to bleach clothes.

Soaking

1. Pour soaking agent/detergent into compartment **II** in accordance with the manufacturer's instructions.

2. Select the desired programme.

3.



Press the button to start the programme.

4.



After approx. ten minutes, press the button to pause the programme.

5.



After the desired soaking time, press the button again to continue or change the programme.

Notes

- Load laundry of the same colour.
- No additional detergent is required; the soaking solution is used for washing.

DETERGENT

Correct selection of detergent

The care label is crucial for selecting the correct detergent, temperature and treatment of the laundry.

Note: Only use detergents for frontloading washing machines, low suds/ detergent foam.

- **Standard detergent with optical brighteners**

Suitable for boil-washable white laundry made from linen or cotton

Programme: Cottons/ cold - max. 90 °C

- **Detergent for colours without bleach or optical brighteners**

Suitable for coloured laundry made from linen or cotton

Programme: Cottons/ cold - max. 60 °C

- **Detergent for colours/delicates without optical brighteners**

Suitable for coloured laundry made from easy-care fibres, synthetic fibres

Programme: Easy-Care/ cold - max. 60 °C

- **Detergent for delicates**

Suitable for delicate, fine fabrics, silk or viscose

Programme: Delicate/Silk/ cold - max. 40 °C

- **Detergent for woollens**

Suitable for wool

Programme: Wool/ cold - max. 40 °C

Saving energy and detergent

For light and normal soiling, you can save energy (lower washing temperature) and detergent.

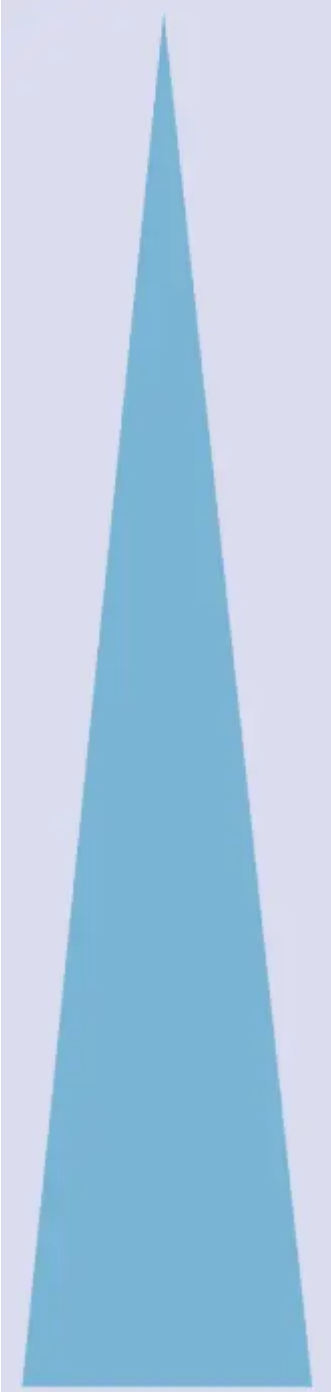
Saving	Soiling/note
<p data-bbox="252 271 855 349">Reduced temperature and detergent quantity as per the recommended dosage</p>  <p data-bbox="252 1816 855 1939">Temperature as per the care label and detergent quantity as per the recommended dosage for heavy soiling</p>	<p data-bbox="927 271 999 304">Light</p> <ul data-bbox="927 331 1458 618" style="list-style-type: none"> ■ Light summer/sports clothing (worn for a few hours) ■ T-shirts, shirts, blouses (worn for up to one day) ■ Guest bed linen and hand towels (used for one day) <p data-bbox="927 696 1026 730">Normal</p> <p data-bbox="927 757 1377 790">Visible dirt or a few light stains, e.g.:</p> <ul data-bbox="927 817 1437 1003" style="list-style-type: none"> ■ T-shirts, shirts, blouses (sweat soaked, worn a few times) ■ Towels, bedding (used for up to one week) <p data-bbox="927 1077 1011 1111">Heavy</p> <p data-bbox="927 1137 1430 1216">Dirt and/or stains clearly visible, e.g. tea towels, baby items, work clothing</p>

Note: When measuring the amount of all detergents/additives/care products and cleaning agents, please always check the manufacturer's instructions and information.

PROGRAM DEFAULT SETTINGS

You can find possible programme default settings in the overview; these differ depending on the model.

These are displayed in the display panel after selecting the programme.

You can change the default settings.

Temp. ° C

(Temperature)

Depending on the programme progress, you can change the preset temperature (in °C) before and during the programme.

To do this, repeatedly select the corresponding button until the required setting is displayed.

The maximum temperature that can be set depends on the programme which has been selected.

Overview of programmes



rpm

(Spin speed)

Depending on the programme progress, you can change the spin speed (in rpm; rotations per minute) before and during the programme.

To do this, repeatedly select the corresponding button until the required setting is displayed.

Setting — — —  : Rinse hold = without final spin, the laundry remains in the water after the final rinse.

You can select "Rinse hold" to prevent creasing if the laundry will not be taken out of the washing machine immediately after the programme has ended.

The maximum speed that can be set depends on the model and programme that have been selected.

Overview of programmes

Ready in

("Ready in" time)

When you select the programme, the relevant programme duration is displayed.

The programme duration is automatically adjusted when the programme is running. Changes to the programme default settings or programme settings also change the programme duration.

Before starting the programme, the programme end ("Ready in" time) can be preselected in increments of one hour (h = hours) up to a maximum of 24 hours.



To do this, repeatedly select the corresponding button until the required setting is displayed.

Note: The programme duration is included in the selected "Ready in" time.





After the start, the preselected time e.g. **8 h** is displayed and the time counts down to the start of the wash programme. The programme duration is then displayed, e.g. **2:30** (hours:minutes).

Changing the preselected time:

You can change the preselected time after the start of the programme as follows:

1. Press Start/Reload  .
2. Press the **Ready in**  button repeatedly until the required number of hours is displayed.
3. Press the **Start/Reload**  button.

Adding laundry while the preselected time continues running:

1. Press Start/Reload  .
2. 
The symbols **YES** and  light up on the display panel. The washing machine door can be opened and laundry can be added.
3. Close the washing machine door.
4. Press the **Start/Reload**  button. The preselected time continues to run.



ADDITIONAL PROGRAMME SETTINGS

You can find an overview of all possible additional settings on the supplementary sheet for the installation and operating instructions.

The settings vary depending on the model.



SpeedPerfect

Button depending on the model

washing in a shorter time while achieving a washing result that is consistent with, but uses more energy than the selected program without the speed setting.

Note: Do not exceed the maximum load



EcoPerfect

Button depending on the model

Energy-optimised washing by reducing the temperature while achieving a washing result that is consistent with the selected program without the eco setting.

Easy-Iron



( Easy-Iron)

Button depending on the model

Reduces creasing thanks to a special spin sequence followed by fluffing and reduced spin speed.

Note: The washing's residual moisture is increased.

Prewash

( Prewash)

Button depending on the model

For heavily soiled laundry.

There will be a prewash cycle at a low temperature before the main washing.

Note: Pour detergent into compartment I for the prewash cycle and into compartment II for the main washing.

Water Plus

( Water+)

Button depending on the model

Higher water level and additional rinse cycle for particularly sensitive skin and/ or for areas with very soft water

Rinse Plus

( Rinse+)

Button depending on the model

Additional rinse cycle, for areas with very soft water or for an even better rinsing result.

OPERATING THE APPLIANCE

Note: **Install** and **connect** washing machine properly. Before the 1st wash, wash once **without** any washing.

Preparing the washing machine

Notes

- Never switch on a damaged washing machine!
 - Inform customer service!
1. Connect the mains plug.
 2. Turn on the tap.
 3. Open the door.
 4. Check that the drum is completely emptied. Empty if necessary.

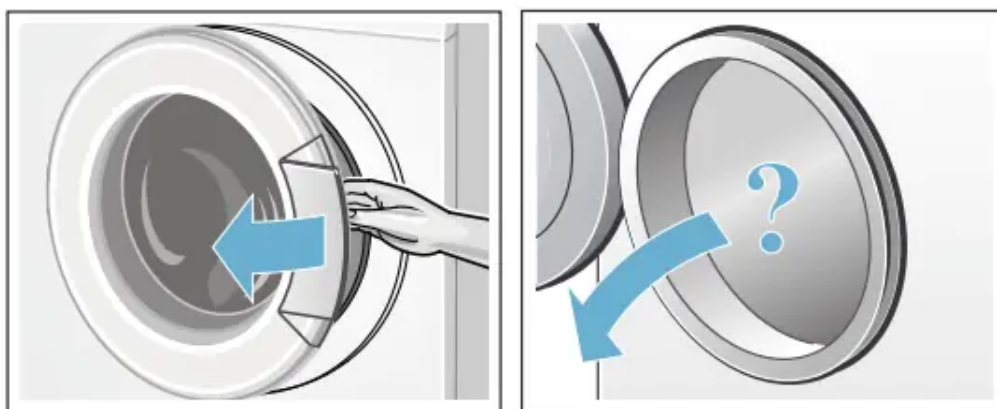

Select programme/switch on the appliance

Note: If you have activated the childproof lock, you must deactivate it before you can set a settings programme.

Use the programme selector to select the required programme. Can be rotated in either direction.

The washing machine is switched on.

The following figures are indicated continuously on the display panel for the selected programme:

- the programme length,
- the preset temperature* (*depending on the model),
- the preset spin speed and
- the maximum load.

Change the programme default settings

You can use the displayed programme presettings or adjust them.

To do this, repeatedly press the corresponding button until the required setting is displayed.

The settings are activated without needing to be confirmed. They are not saved when the appliance is switched off.

Programme default settings

Select additional programme settings

By selecting additional settings, you can better adapt the washing process to your items of laundry.

The settings can be selected or deselected depending on the programme progress.

The indicator lamp for the button lights up if a setting is active. The settings are not saved when the appliance is switched off.

Additional programme settings

Placing laundry into the drum

Warning Risk to life!

Items of laundry pretreated with cleaning agents that contain solvents, e.g. stain remover/cleaning solvent, may cause an explosion after being loaded into the washing machine. Hand-rinse these items of laundry thoroughly beforehand.

Notes

- Mix items of washing of varying sizes. Laundry items of different sizes distribute themselves better during the spin cycle. Individual laundry items may cause an unbalanced load.

- Observe the maximum indicated load. Overfilling adversely affects the washing result and encourages creasing.

1. Unfold presorted laundry items and place them in the washing drum.
2. Ensure that no items of laundry are trapped between the door and rubber seal.

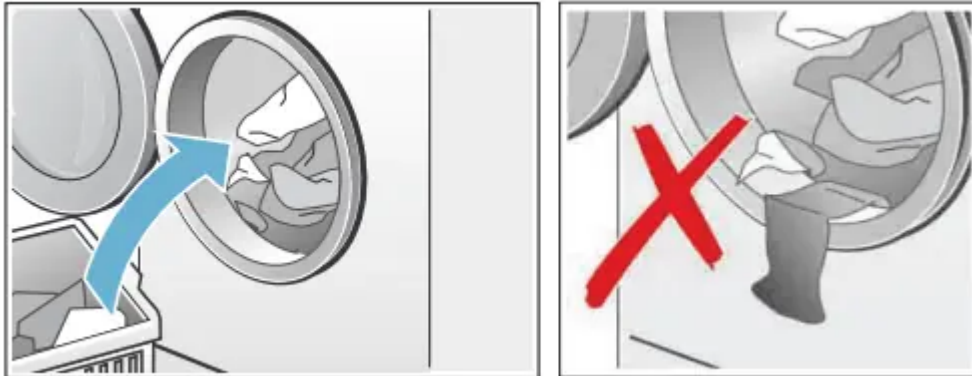

3. Close the door.



The indicator light on the Start button flashes, and the default settings for the programme appear continuously on the display panel. Changes may be made to the default settings.

Measure and add detergent and care products

Caution! Damage to the appliance

Cleaning agents and agents for pretreating laundry (e.g. stain removers, prewash sprays, etc.) may cause damage if they come into contact with the surfaces of the washing machine.

Do not allow these agents to come into contact with the surfaces of the washing machine. If necessary, immediately wipe away spray residue and other residues/ droplets with a damp cloth.

Dosing

Dose detergents and care products according to:

- The water hardness (ask your water supply company)

- The manufacturer's instructions on the packaging
- The amount of laundry
- Soiling

Filling

1. Pull out the detergent drawer.

Warning Eye/skin irritation!

- Detergent and care products may run out if the detergent drawer is opened while the machine is in operation.
- Open the drawer carefully.
- Rinse eyes/skin thoroughly if they come into contact with detergents or care products.
- If swallowed accidentally, seek medical advice.

2. Add detergent and/or care products

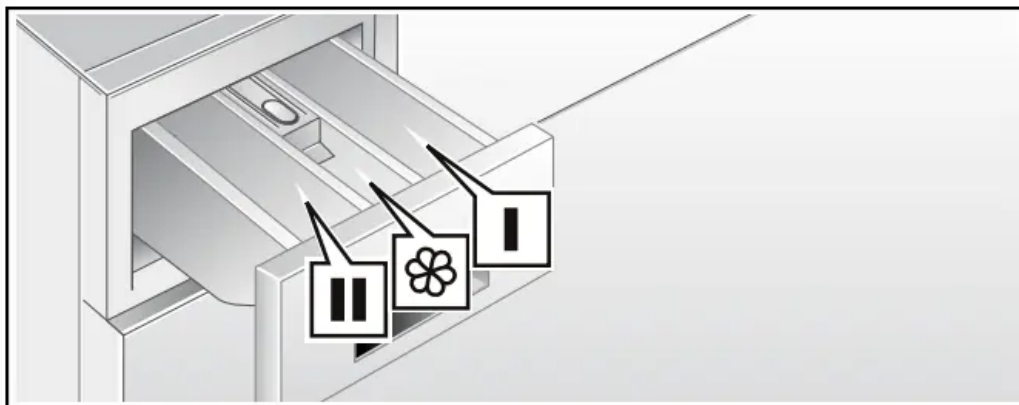

Dispenser I Detergent for prewash



Dispenser Softener, starch. Do not exceed maximum dose

Dispenser II Detergent for main wash, water softener, bleach, stain remover

Notes

- When measuring the amount of all detergents, additives, care products and cleaning agents, always follow the manufacturer's instructions.
- Dilute thick-consistency fabric softener and fabric conditioner with a little water. This will prevent blockages.
- Pour liquid detergent into corresponding dispenser and place in drum.

Start the programme

Select the Start button. The indicator light lights up and the programme starts.

Note: You will need to press and hold the  button to start the programme. This prevents the programme from being started if something accidentally brushes against the button.



The display panel shows the Ready in time while the programme is running or the programme length and the programme progress symbols once the wash cycle has started.

Note: If you want to lock the programme to prevent it from being inadvertently adjusted, you can select the childproof lock as follows.

Childproof lock

You can lock the washing machine to prevent the functions you have set from being changed inadvertently. To do this, activate the childproof lock when the programme has started.

To activate/deactivate the childproof lock, press and hold the Start button for approx. 5 seconds. The d symbol appears in the display panel.

-  lights up: The childproof lock is active.
-  flashes: The childproof lock is active, and the programme selector has been adjusted. To prevent the programme from stopping, turn the programme selector back to the original programme. The symbol lights up again.



Note: The childproof lock may remain activated until the next programme starts, even after the washing machine has been switched off. You must then deactivate the childproof lock before starting the programme and activate it again as necessary once the programme has started.

Adding laundry

After starting the programme, you can add or remove laundry if necessary.

To do this, Select the Start button. The washing machine checks whether adding laundry is possible.

If the following appears in the display panel:

- **Both** the **YES** and  symbols light up, it is possible to add laundry.
- **NO** and  flash, wait until **YES** and G light up. Do not open the door until **both** the **YES** and  symbols light up.
- **NO** lights up, it is not possible to add laundry.

Notes

- For safety reasons, the door remains locked when the water level or temperature is high, or while the drum is turning, and it is not possible to add laundry during this time. Select the Start button to continue the programme.
- Do not leave the door open for a prolonged period - water could run out of the laundry.

Changing the programme

If you have started a wrong programme by mistake, you can change the programme as follows:



1. Select the Start button to pause the programme.
2. Select another programme.
3. Select Start button for starting the programme. The new programme starts from the beginning.

Cancel the programme

For programmes at high temperatures:

1. Select the Start button to pause the programme.
2. To cool down washing: Select q Rinse programme.
3. Select the Start button.



For programmes at low temperatures:

1. Select the Start button to pause the programme.
2. Select  Spin/Drain  (if only a drain cycle is required: set rpm (spin speed) to - - -).
3. Press the Start button again.

Programme end during rinse hold

- - - appears in the display panel, and the start button indicator light flashes.

To end the programme:

1. Select  Spin/Drain  (if only a drain cycle is required: set rpm (spin speed) to - - -).
2. Select the Start button.

Programme end

End appears in the display panel.

If the  symbol also appears in the display panel, the washing machine has detected too much foam during the wash programme and automatically switched on a rinse cycle to remove the foam.

Note: Add less detergent to the next washing cycle with the same load.

Removing laundry/switching off the appliance

1. Open the door and remove the washing.
2. Set the programme selector to the "Off" position. The appliance is switched off.
3. Turn off the tap.

Not required for Aqua-Stop models. Contents of package

Notes

- Do not leave any items of laundry in the drum. They may shrink in the next wash or discolour another item.
- Remove any foreign objects from the drum and the rubber seal -risk of rusting.

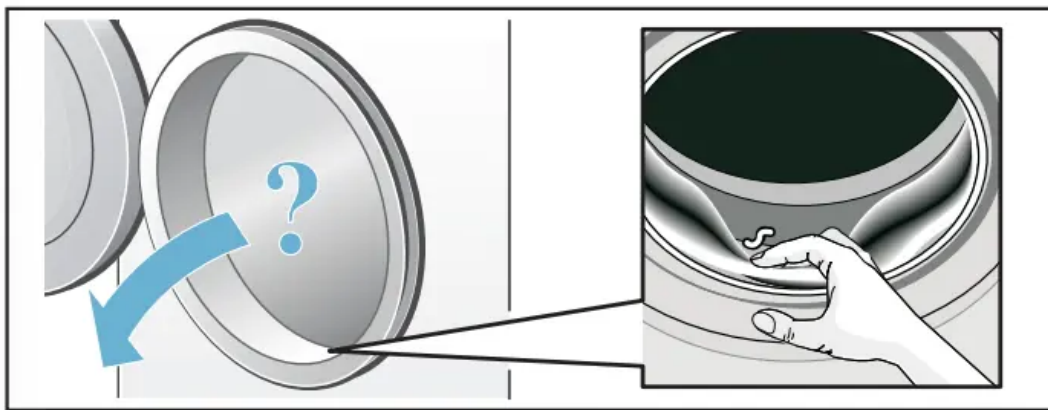

- Leave the door and detergent drawer open so that any residual water can dry away.
- Always remove the washing.
- Always wait until the programme ends, as the appliance could still be locked.
- If the display panel goes off at the end of a programme, the energysaving mode is active. To activate, select any button.

SENSORS

Automatic load sensing

The automatic load-sensing function perfectly adapts the water consumption to each programme depending on the type of fabric and the load.

Unbalanced load detection system

The automatic unbalanced load detection system detects imbalances and ensures even distribution of the laundry by repeatedly starting and stopping the drum spinning.

If the laundry is extremely unevenly distributed, the spin speed is reduced or the spin cycle is not performed for safety reasons.

Note: Place large and small items of laundry evenly in the drum.

VoltCheck

The automatic voltage control system detects unauthorised voltage drops during the washing process.

Note: Whenever there is an undervoltage, the colon flashes on the Ready in display on the display panel.



When the supply voltage is stable again, the programme continues running. The colon on the Ready in display stops flashing.

If the interruption causes the programme to be extended, the dot on the display flashes.



The voltage control system is activated when a program is started.

SETTING THE SIGNAL





1. Activate the setting mode for the signal volume

Set to	Press and hold the 0 button and turn one position to the right.	Press and hold the button for approx. five seconds until the display elements light up. Setting mode is activated.

2. Set the volume for the button signals (depending on the model)

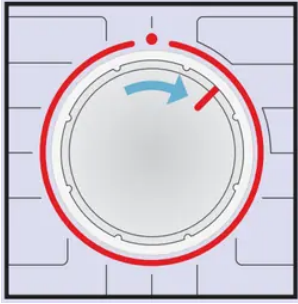
Press the button repeatedly until the desired volume is reached. 	Go to point 3 or	Set to to exit the setting mode for the signal volume.

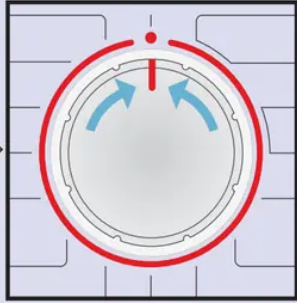
3. Set the volume for the information signals

		
Turn the dial one position to the right.	Press the button repeatedly until the desired volume is reached.	Set to  to exit the setting mode for the signal volume.

CLEANING AND MAINTENANCE

Warning Danger of death!

There is a risk of electric shock if you touch live components.

Switch off the appliance and unplug the mains plug.

Warning Risk of poisoning!

Toxic vapours can be produced by cleaning agents that contain solvents, e.g. cleaning solvent.

Do not use cleaning agents that contain solvents.

Caution! Damage to the appliance

Cleaning agents that contain solvents, e.g. cleaning solvent, can damage surfaces and components in the machine.

Do not use cleaning agents that contain solvents.

Machine housing/control panel

- Wipe the housing and the control panel with a soft, damp cloth.
- Remove the detergent residue immediately.
- Do not clean with a water jet.

Drum

Use chlorine-free cleaning agents and not steel wool.

Descaling

Descaling should not be necessary if the detergent is measured out correctly. However, if it is required, follow the manufacturer's instructions for the descaling agent. Suitable descalers can be obtained via our website or from our after-sales service.

Detergent drawer and housing

If the washing machine contains detergent or fabric softener residues:

1. Pull out the detergent drawer. Press down the insert and fully remove the drawer.
2. To remove the insert: Push the insert upwards from below with your finger.

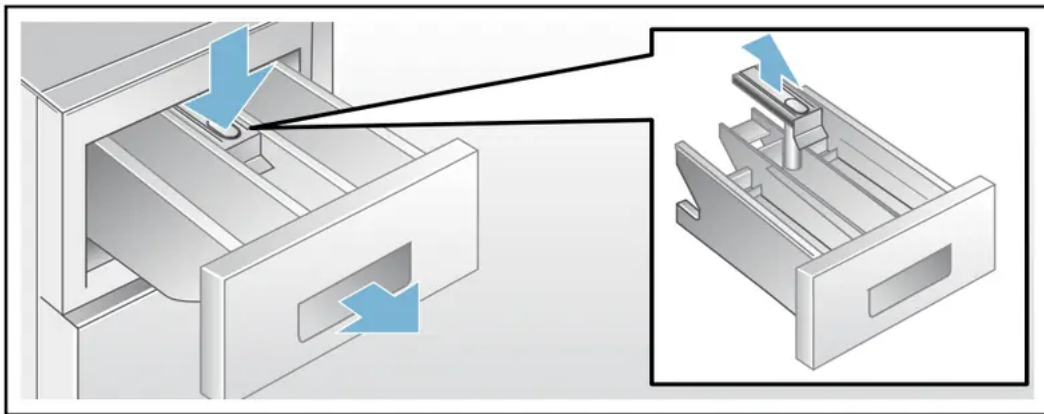

3. Clean the detergent dispenser tray and insert with water and a brush, and dry it. Clean the inside of the housing as well.
4. Fit the insert and lock it in place (push the cylinder onto the guide pin).
5. Push in the detergent drawer.

Note: Leave the detergent drawer open so that any residual water can evaporate.

Detergent solution pump blocked

Warning Risk of scalding!

When you wash at high temperatures, the water gets very hot. If you come into contact with the hot water, you may be scalded.

Allow the water to cool down.

1. Turn off the water tap so that no more water can flow in and has to be drained via the drain pump.
2. Switch off the appliance. Disconnect the mains plug.
3. Open and remove the service flap.

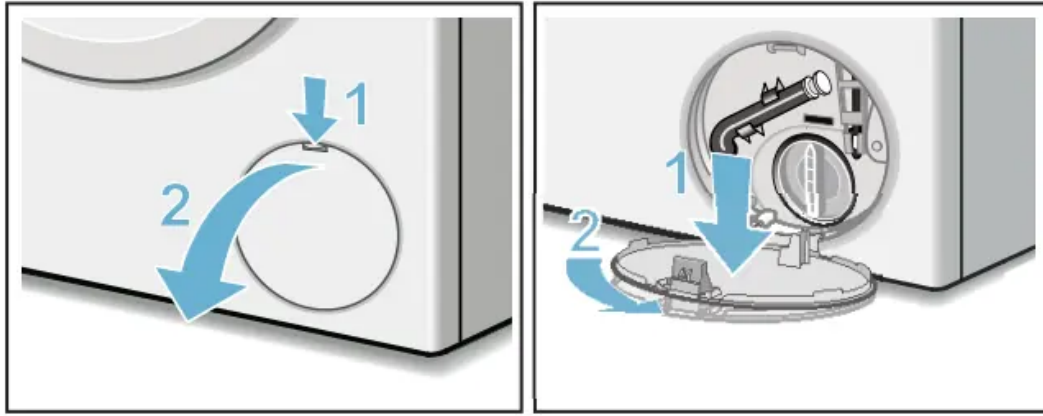

4. Take the drain hose out of the retainer.

Remove the sealing cap, allow the detergent solution to flow out into a suitable container.

Replace the sealing cap and place the drainage hose in the retainer.

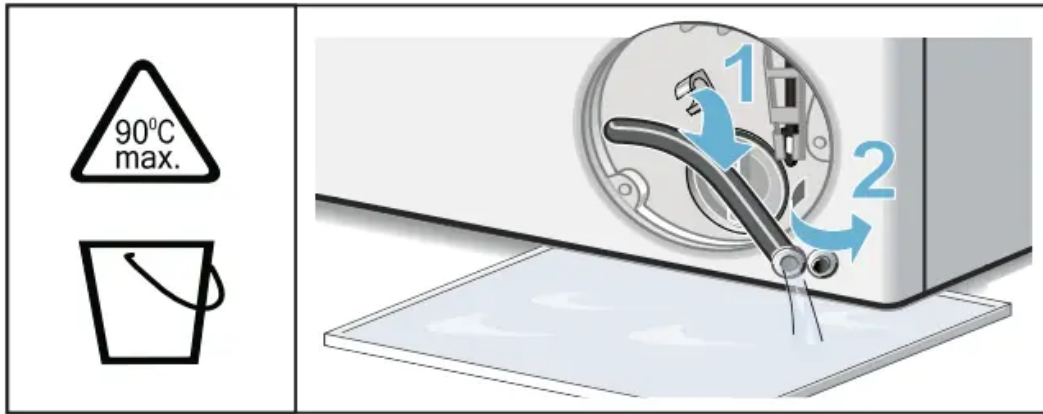

5. Carefully unscrew the pump cover, residual water may leak out.

Clean the interior, pump cover thread and pump housing. The impeller in the detergent solution pump must be able to rotate.

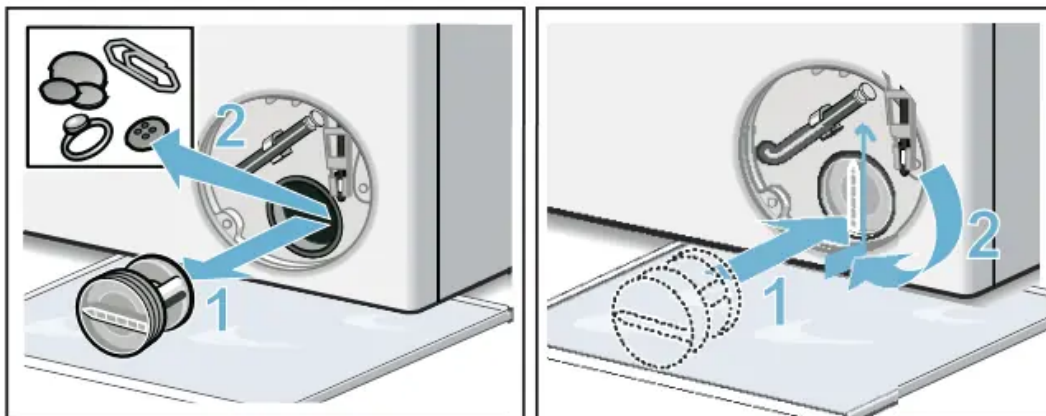

Refit the pump cover and screw it on tightly. The handle must be in a vertical position.

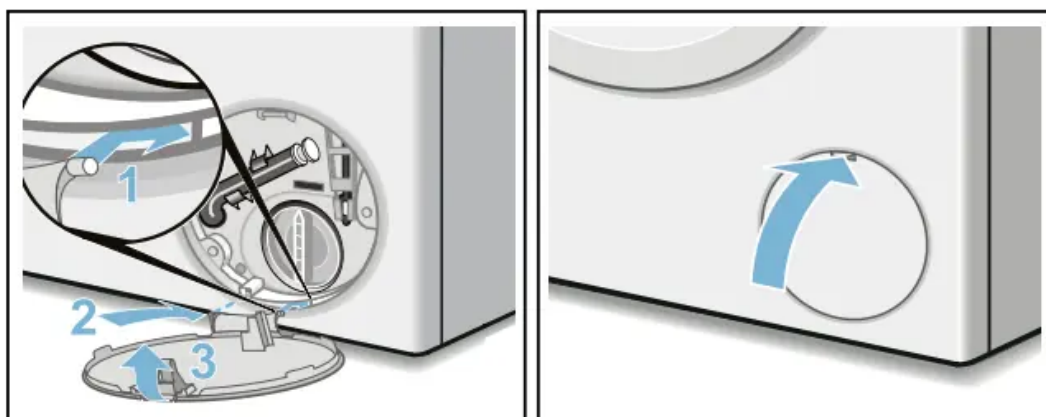

6. Place the service flap back on, lock it into place, and close it.



Note: To prevent unused detergent from flowing straight into the drain during the next wash: Pour

1 litre of water into compartment II and start the  Spin/Drain  programme (if only drain cycle is required, set rpm  on - - -).

The drain hose at the siphon is blocked

1. Switch off the appliance. Disconnect the mains plug.
2. Loosen the hose clamp. Carefully remove the drain hose; residual water may leak out.
3. Clean the drain hose and siphon connecting piece.

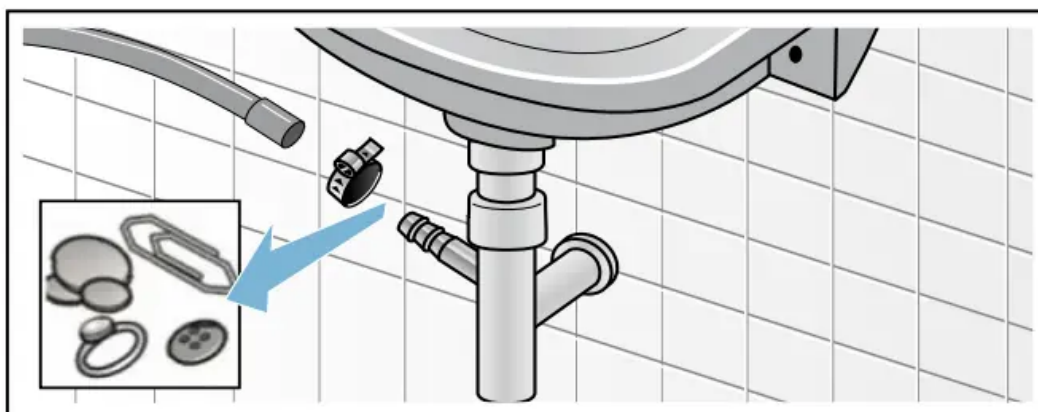



4. Reattach the drain hose and secure the connection using the hose clamp.

Filter in the water supply is blocked

For this, first reduce the water pressure in the supply hose:

1. Turn off the water tap.

2. Select any programme (except Rinse/Freshen up  //  Spin/Drain ).

3. Press **Start/Reload**  . Allow the programme to run for approximately 40 seconds.

4. Set the programme selector to off position. Disconnect the mains plug.

5. Clean the filter on the water tap: Remove the hose from the water tap. Clean the filter with a small brush.

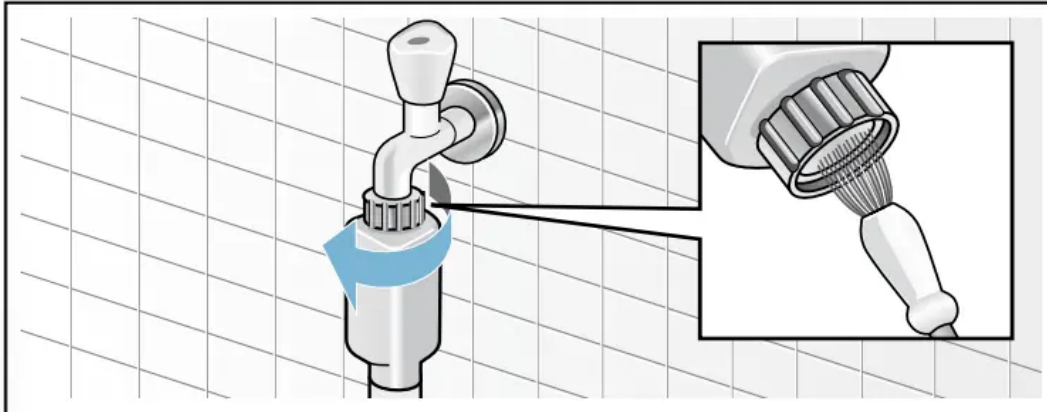

6. For standard and Aqua-Secure models, clean the filter on the rear of the appliance:

Remove the hose from the rear of the appliance,

Remove the filter using pliers and clean the filter.

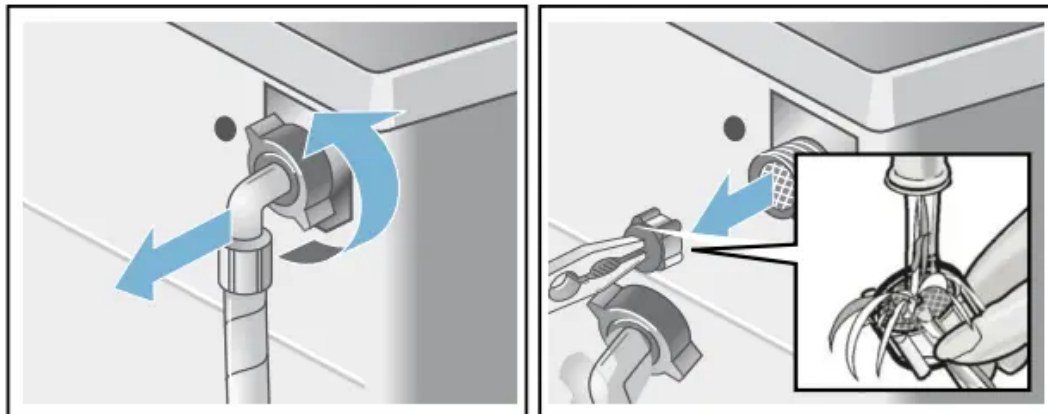

7. Connect the hose and check for leaks.

TROUBLESHOOTING

Emergency release

(depending on the model)

e.g. in the event of a power outage

Note: The programme will continue running when the power supply has been restored.

Warning Risk of scalding!

When you are washing at high temperatures, there is a risk of scalding if you come into contact with detergent solution and laundry.

If possible, leave it to cool down.

Warning Risk of injury!

You may injure your hands if you reach into the drum while it is turning.

Do not reach into the drum when it is turning. Wait until the drum has stopped turning.

Caution!

Water damage



Any escaping water may cause water damage. Do not open the washing machine door if water can be seen through the glass.

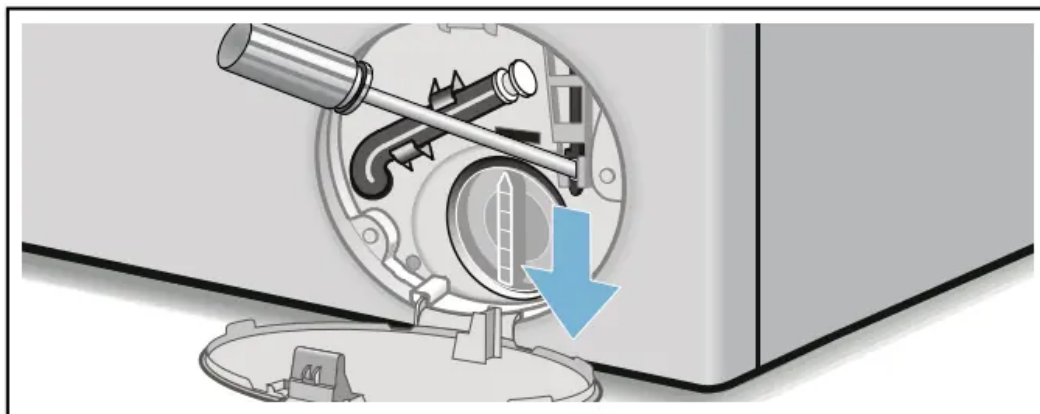

If the laundry has to be removed, the washing machine door can be opened as follows:







1. Switch off the appliance.
2. Disconnect the mains plug.
3. Drain the water.
4. Pull the emergency release downwards with a tool and release. The washing machine door can now be opened.







Information on the display panel



Display	Cause/remedial action
YES	The washing machine door is unlocked. It is possible to add laundry.
NO	<ul style="list-style-type: none"> • The temperature is too high. Wait until the temperature falls. • Water level too high. Not possible to add laundry. If necessary, close the washing machine door immediately. To continue the programme, press <p style="text-align: center;">Start/ Reload </p>
 flashes	<ul style="list-style-type: none"> • Laundry may be caught. Please open and close the washing machine door again and press Start/ Reload <p style="text-align: center;"></p> <ul style="list-style-type: none"> • If necessary, push the washing machine door closed or remove the laundry and push it closed again. • If necessary, switch the appliance off and on again; set the programme and make your individual settings; start the programme.
E:17	<ul style="list-style-type: none"> • Turn the water tap on fully, • The supply hose is kinked/trapped, • The water pressure is too low. <ul style="list-style-type: none"> ◦ Clean the filter in the water supply. ◦ If an additional water filter has been installed (depending on model) check for contaminants and clean if required → separate installation and cleaning instruction for water filter.
E:18	<ul style="list-style-type: none"> • The detergent solution pump is blocked. Clean the detergent solution pump.

Display	Cause/remedial action
	<ul style="list-style-type: none"> • The drain hose/waste pipe is blocked. Clean the drain hose at the siphon.
E:23	Water in the base tub, appliance leaking. Turn off the water tap. Call the after-sales service.
	The childproof lock is activated; to deactivate:
 flashes	Too much foam detected, a rinse cycle has been switched on.
<ul style="list-style-type: none"> ■ ■ 	The mains voltage is too low.
<ul style="list-style-type: none"> ■ 	Undervoltage in the wash programme. The programme is extended.
Other displays	Switch off the appliance, wait for 5 seconds and switch it back on again. If the display appears again, call the after-sales service.

Faults	Cause/remedial action
Water is leaking out.	<ul style="list-style-type: none"> • Attach/replace the drainage hose correctly. • Tighten the screw connection of the supply hose.
No water supply. Detergent not dispensed.	<ul style="list-style-type: none"> • Start/Reload  not pressed? • Tap not turned on? • Filter blocked? Clean the filter. <p>Note: If an additional water filter has been installed (depending on model), check for contaminants and clean if required → separate installation and cleaning instruction for water filter.</p> <ul style="list-style-type: none"> • Supply hose kinked or trapped?
Washing machine door cannot be opened.	<ul style="list-style-type: none"> • Safety function active. <p>Note: For safety reasons, the washing machine door remains locked when the water level or temperature is high (See → Cancel the programme) or while the drum is rotating.</p> <ul style="list-style-type: none"> • Is the  Childproof lock activated? Deactivate •  (Rinse hold = without final spin) selected? • Can the door be opened by emergency release only?
Programme does not start.	<ul style="list-style-type: none"> • Start/Reload  pressed or Ready in  time selected? • Washing machine door closed? • Is the  Childproof lock activated? Deactivate

Faults	Cause/remedial action
<p>Detergent solution is not emptied.</p>	<ul style="list-style-type: none"> •  (Rinse hold = without final spin) selected? • Clean the detergent solution pump. • Clean the waste pipe and/or drainage hose.
<p>Water not visible in the drum.</p>	<p>Not a fault - water below the visible area.</p>
<p>Spin result not satisfactory. Laundry wet/too damp.</p>	<ul style="list-style-type: none"> • Not a fault - the unbalanced load detection system has interrupted the spin because the laundry is unevenly distributed. <p>Distribute large and small items of laundry evenly in the drum.</p> <ul style="list-style-type: none"> • Spin speed selected too low?
<p>Spin cycle started and stopped several times.</p>	<p>Not a fault - the unbalanced-load detection system is adjusting the imbalance.</p>
<p>The programme duration is longer than usual.</p>	<ul style="list-style-type: none"> • Not a fault - the unbalanced-load detection system is adjusting the imbalance by repeatedly distributing the laundry. • Not a fault - the foam detection system active - adds an additional rinse cycle.
<p>The programme duration changes during the wash cycle.</p>	<p>Not a fault - the programme sequence is optimised for the particular washing process. This may lead to occasional changes in the programme duration in the display panel.</p>
<p>Residual water in the compartment</p>	<ul style="list-style-type: none"> • Not a fault - the effect of the care product is not affected. • Clean the insert if necessary.

Faults	Cause/remedial action
 for care products.	
Odours in the washing machine.	 Run the Drum clean programme without laundry. Use standard detergent.
The symbol  flashes in the display panel. Foam may escape from the detergent drawer.	<ul style="list-style-type: none"> • Too much detergent used? Mix one tablespoon of fabric softener with 1/2 litre water and pour into compartment II (not for outdoor fabrics, sportswear fabrics or those made with down). Reduce the detergent dosage for the next wash cycle. <ul style="list-style-type: none"> • Improper detergent use? Only use detergent suitable for front-loading washing machines.
Intense noise, vibrations and "wandering" during spinning.	<ul style="list-style-type: none"> • Is the appliance levelled? Level the appliance. • Are the appliance feet fixed? Secure the appliance feet. • Transport locks removed? Remove the transport locks.
Display panel/ indicator lamps do not function during operation.	<ul style="list-style-type: none"> • Power cut? • Circuit breakers tripped? Switch the circuit breakers back on or replace them. • If the fault occurs repeatedly, call the after-sales service.
Detergent residues on the laundry.	<ul style="list-style-type: none"> • Occasionally, phosphate-free detergents contain water-insoluble residues.

Faults	Cause/remedial action
	<ul style="list-style-type: none"> • Select Rinse/Freshen up  or brush the laundry after washing.
<p>NO appears on the display panel in reload mode.</p>	<ul style="list-style-type: none"> • Water level too high. Not possible to add laundry. Close the washing machine door immediately, if necessary. • To continue the programme, press Start/Reload 
<p>YES appears on the display panel in reload mode.</p>	<p>The washing machine door is unlocked. It is possible to add laundry.</p>
<p>The colon in the "Ready in" display (:;) flashes on the display panel.</p>	<p>The mains voltage is too low.</p>
<p>The single dot (.) flashes.</p>	<p>The undervoltage has caused the wash programme to be extended.</p>
<p>If you cannot correct a fault yourself (after switching off/on) or a repair is required:</p> <ul style="list-style-type: none"> • Set the programme selector to off position. The appliance is switched off. • Unplug the mains plug from the socket. • Turn off the tap and call the after-sales service. 	

Warning

This content is compiled from multiple sources and is provided for reference purposes only. It may not be complete or fully applicable to all situations. If you are unable to resolve your issue, please contact the product manufacturer or an authorized service provider for official support.

