

OVERVIEW

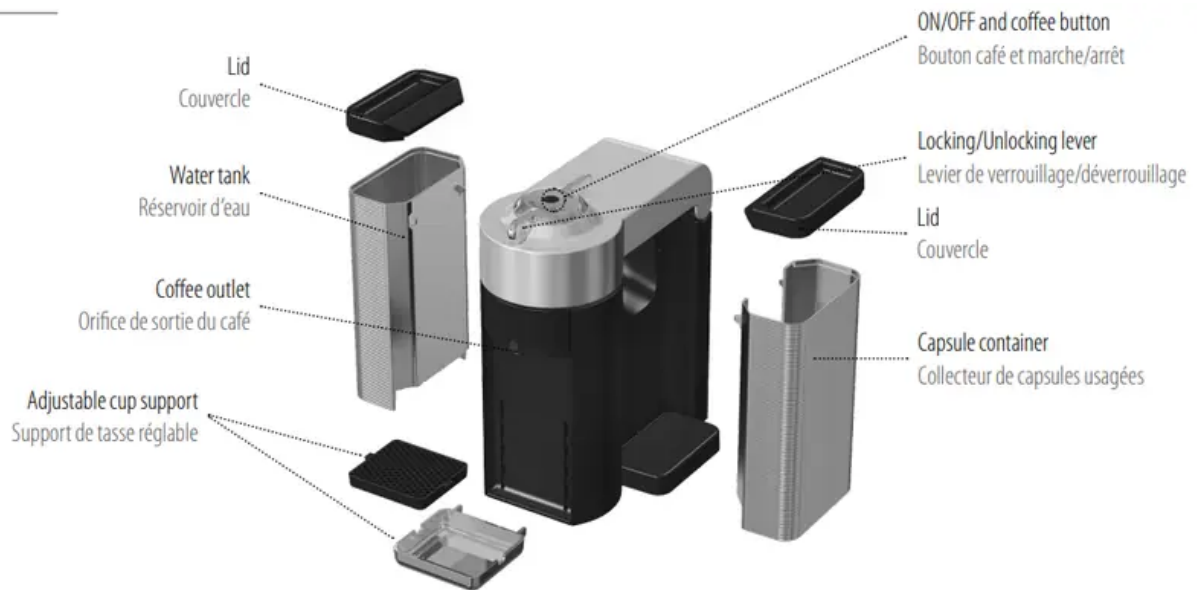

PACKAGING CONTENT



FIRST USE OR AFTER A LONG PERIOD OF NON-USE

CAUTION: first read the important safeguards to avoid risks of fatal electrical shock and fire

1. Rinse and clean the water tank before filling it only with fresh potable water. Put the water tank in place.

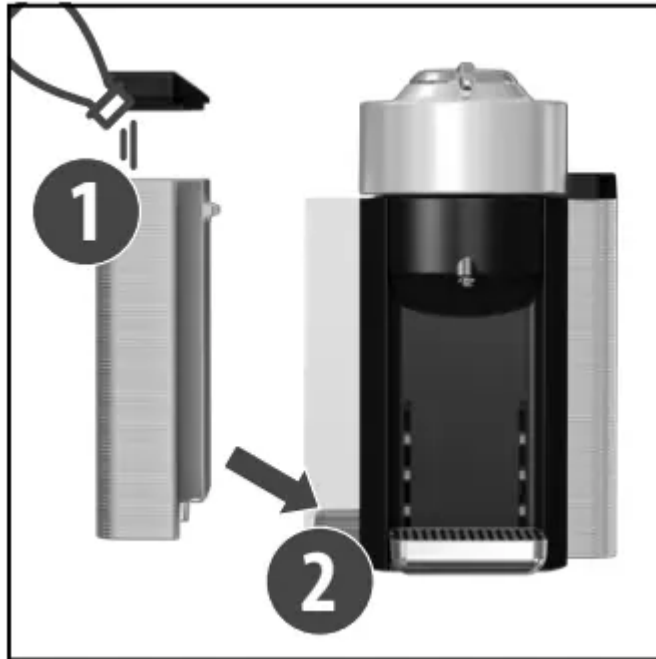

2. Ensure the capsule container, a cup and the cup support (if necessary for the selected cup size) are in place. For your safety, operate the machine only with cup and capsule container in position.

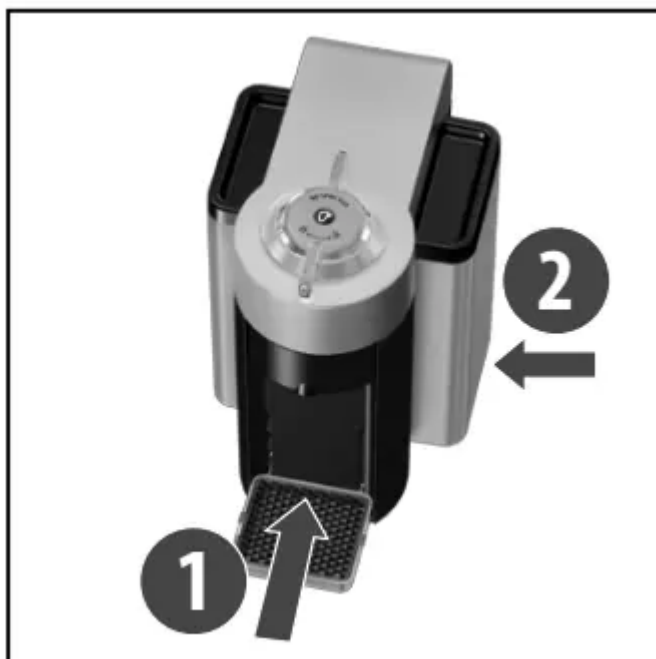

3. Plug the machine into the outlet.

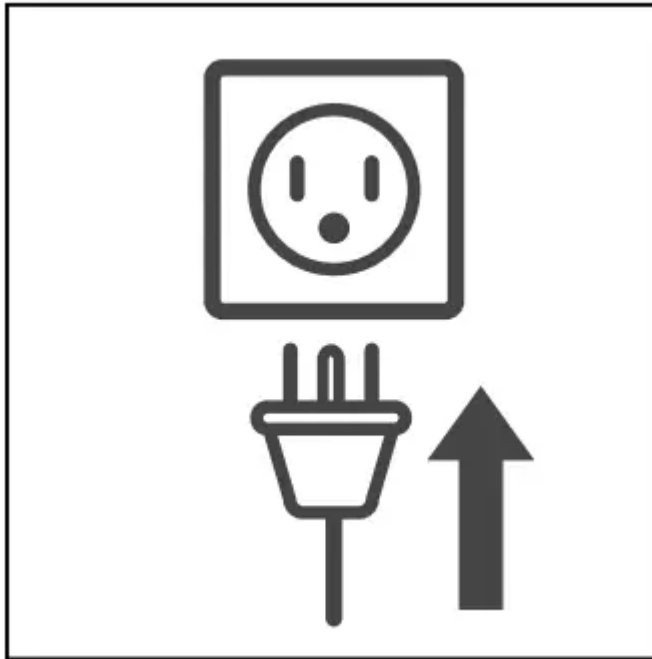

4. Turn the machine "ON" by pushing the button. The button will gradually illuminate as the machine heats up in approximately 15 seconds.

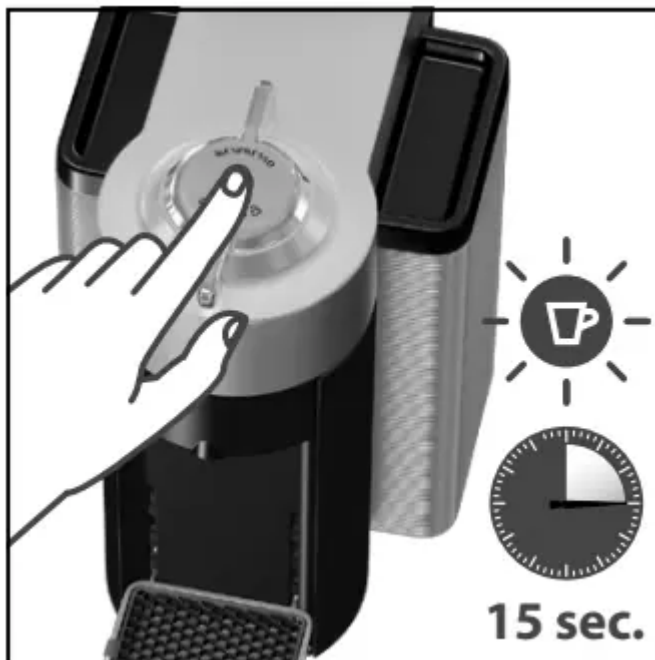

5. Steady light indicates the machine is ready

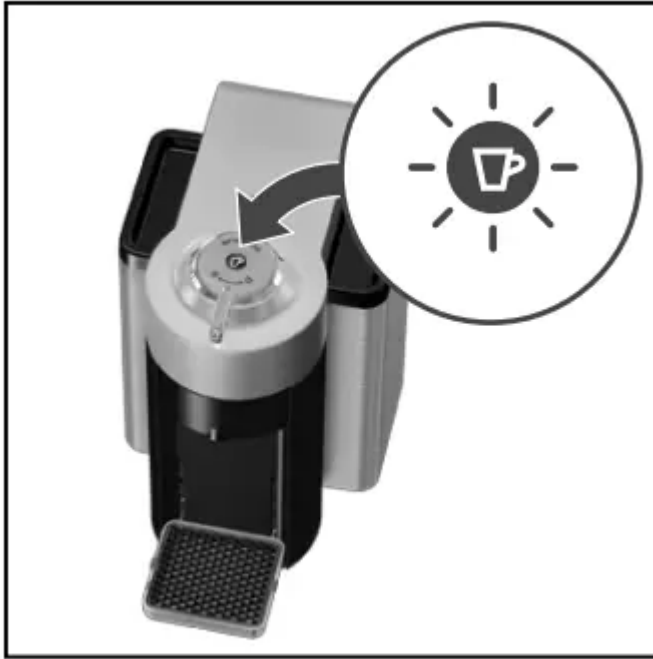

6. Place a container of at least 12.5 fl oz./0.4 l under the coffee outlet.



7. Close the machine if open and lock the machine by turning the lever left to the lock symbol on the machine head.



8. Press the button 3 times within 2 seconds to start cleaning and let the cleaning procedure complete automatically. It will take less than 2 minutes before a flow comes out. The procedure consists of 3 cycles of pumping water in, internal cleaning and water flowing from the outlet to complete.

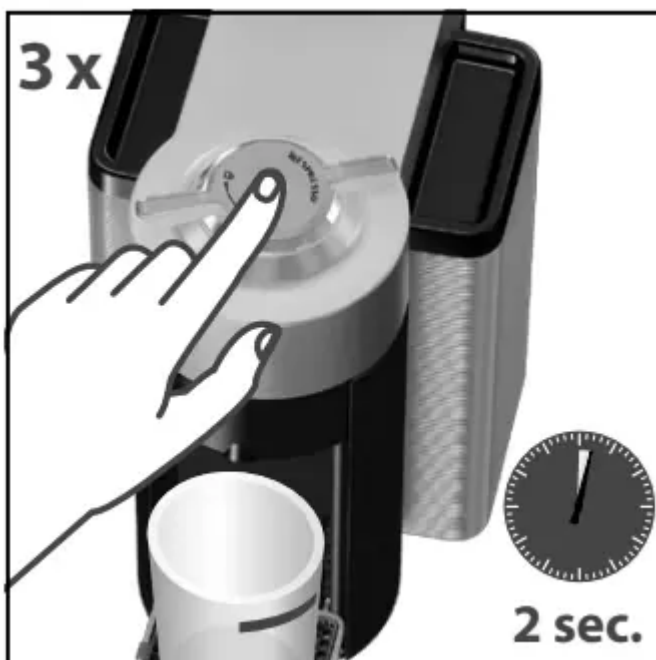

9. This operation may take up to 5 minutes. The procedure can be stopped at any time by pushing the button. The button will go to steady light. In case you want to resume the cleaning process, push the button again. To brew a coffee, insert a capsule, then close,

lock the machine by turning the lever left and push the button

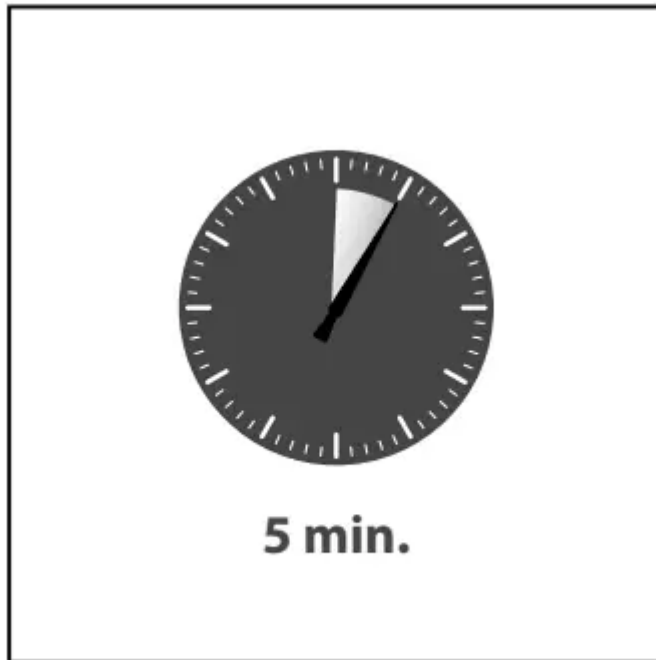

COFFEE PREPARATION

1. Fill the water tank with fresh potable water.

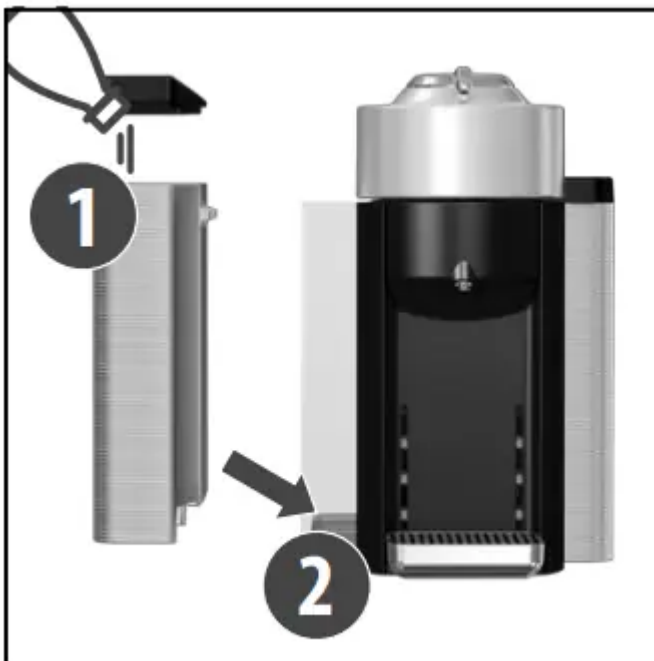

2. Turn the machine "ON" by pushing the button.



3. Lights will blink for approximately 15 seconds while the machine is heating up.



4. Steady light indicates the machine is ready.



5. The factory settings and recommended cup sizes are: 14 fl oz./414 ml for Alto, 7.77 fl oz./230ml for Coffee, 1.35 fl oz./40ml for Espresso

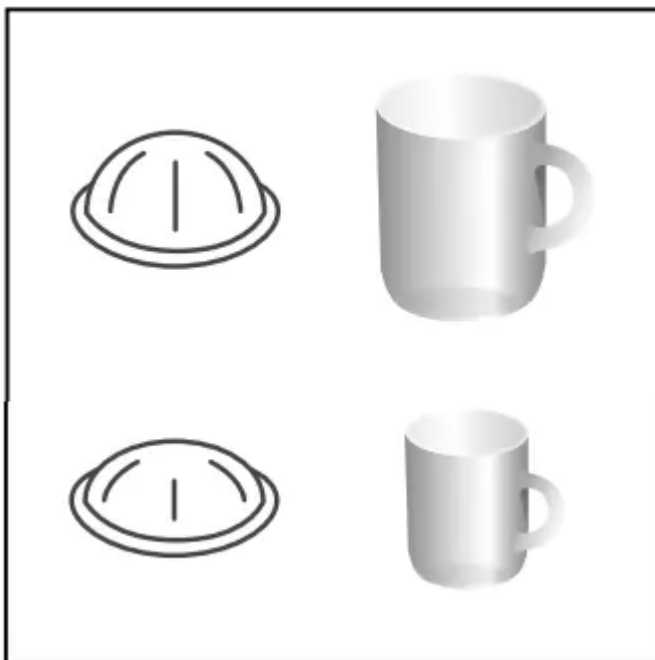

6. The cup support has 4 positions and can be temporarily removed to accommodate various cup sizes.

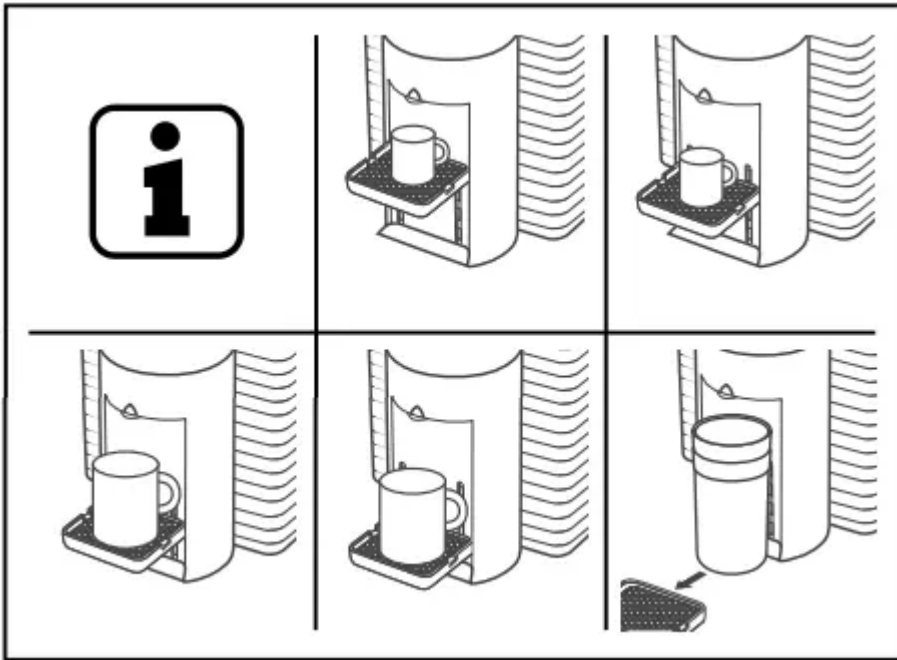

7. Place a cup of sufficient capacity under the coffee outlet. Risk of scalding may occur due to overflowing.



8. Unlock and open the machine head completely.



9. This machine operates with Nespresso Vertuo capsules. Nespresso classic capsules cannot be used in this machine.

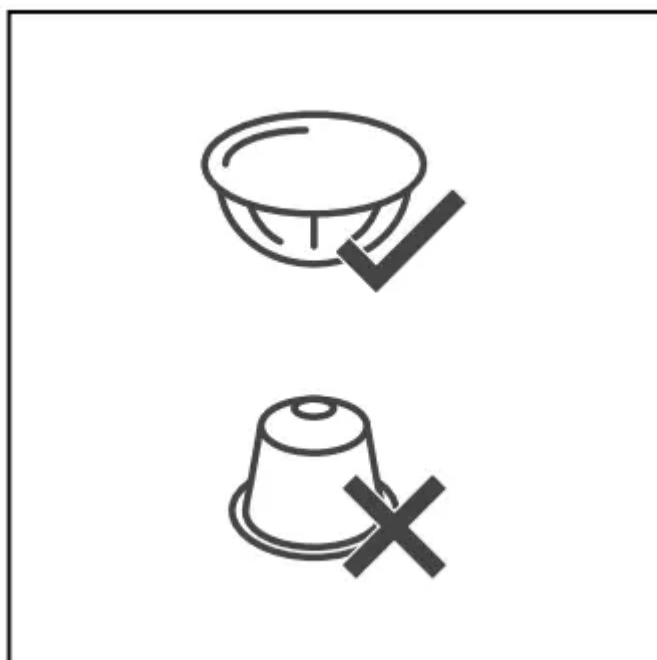

10. Insert a Nespresso Vertuo capsule with the dome shape at the bottom. Be careful not to injure yourself on sharp points or trap your fingers when reaching inside the machine.



NOTE: to avoid damaging the machine, use only fresh, unused capsules. Ensure previous capsule has been ejected before inserting a fresh one.

11. Close the head and lock the machine by turning the lever left to the lock symbol on the machine head.



NOTE: you can do this even when the machine is still heating up. The coffee will then flow automatically when the machine is ready

12. Push the button to start the coffee preparation. It will take some time before the coffee flow comes out (due to barcode reading and coffee pre-wetting).

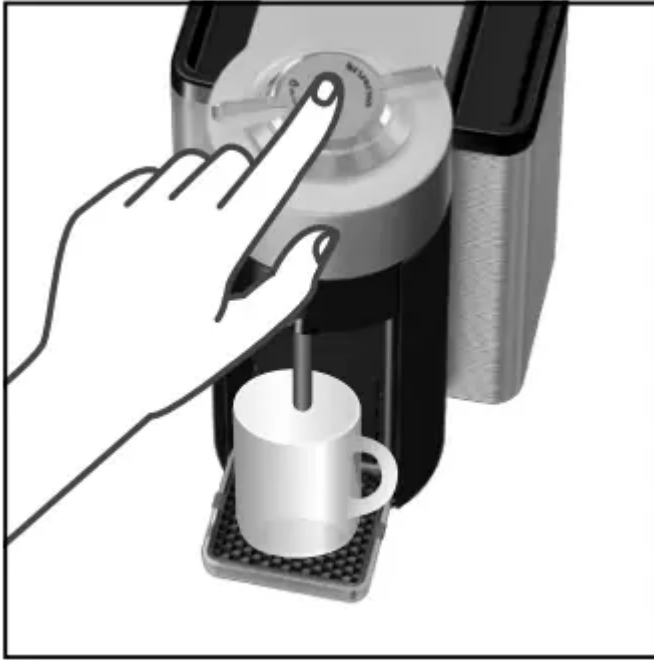

NOTE: the machine will automatically recognize the inserted capsule and select the coffee preparation parameters and cup length defined by Nespresso coffee experts to extract the coffee blend at its best.

13. To stop the coffee flow early, push the button.



14. To manually top off your coffee, push the button and push again to stop when desired volume is reached.



15. Turn the lever to the right and open the head to automatically eject the capsule.



ENERGY SAVING CONCEPT

The machine can be turned "OFF" at any time by holding the button for 3 seconds. Automatic "OFF" Mode: the machine will turn off automatically after 9 minutes of non-use.



PROGRAMMING THE WATER VOLUME

1. The programming is specific to each capsule size, Alto, Coffee or Espresso. Cup sizes can be reprogrammed from 0.3 fl oz./10 ml to 17 fl oz./500 ml.

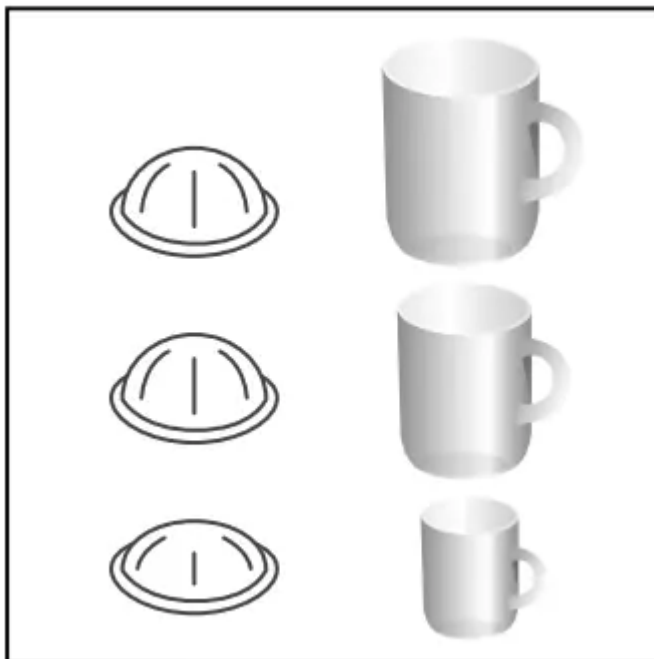

2. Open the machine head; Insert the capsule blend you want to program; Close the head; Lock the machine

3. Push and hold the button until desired volume is reached.



4. Water volume level is now stored for the capsule size used for the programming.

NOTE: once a customer-specific volume is programmed by the user, every time that capsule size is inserted in the machine, the preparation will stop at the user-programmed cup size. it is possible to restore cup size volumes, refer to 'Reset to factory settings' section.

RESET TO FACTORY SETTINGS

1. Open the machine head and let the used capsule be ejected.



2. Close the head. Leave the lever in “UNLOCKED” position.



3. Push the button 5 times within 3 seconds. The button will blink slowly 5 times to confirm reset is done



EMPTYING THE SYSTEM BEFORE A PERIOD OF NON-USE, FOR FROST PROTECTION OR BEFORE A REPAIR

1. Empty the water tank and put it in place



2. Place a container under the coffee outlet.



3. Unplug the power cord

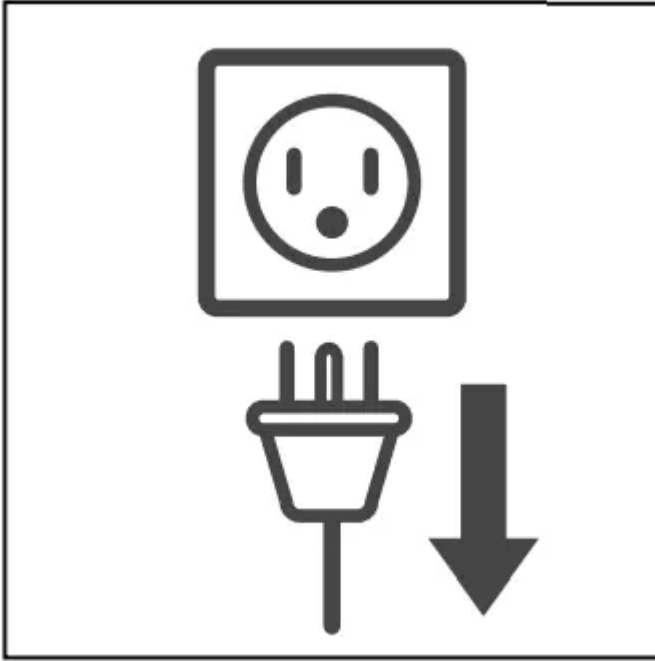

4. Open the machine head and let the used capsule be ejected.



5. Reclose the head and turn lever left until “LOCKED” position.



6. Push and hold the button while replugging the power cord and then release the button

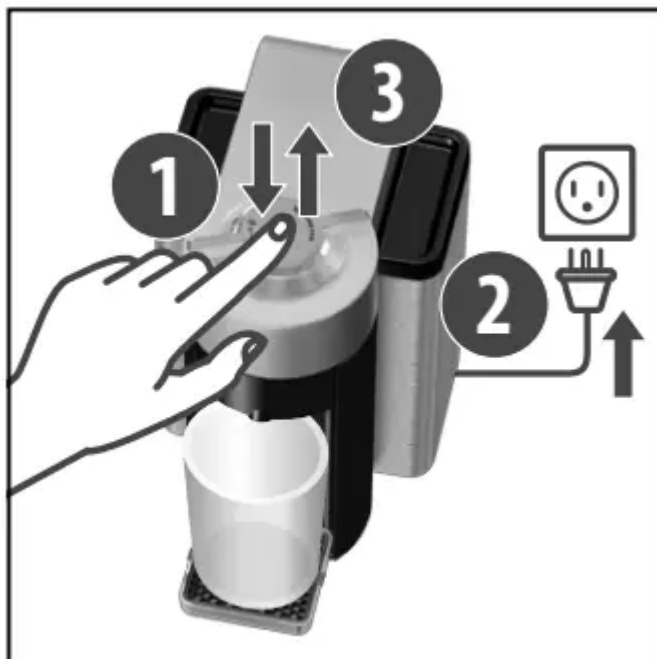

7. Machine turns “OFF” automatically when machine is empty.

CAUTION: caution should be exercised when plugging in the coffee machine with the button pressed as the machine evacuates remaining liquids using heat. Small quantities of steam may emit from the machine.



CLEANING

1. Rinse and clean the water tank before filling it with fresh potable water. Put the water tank in place

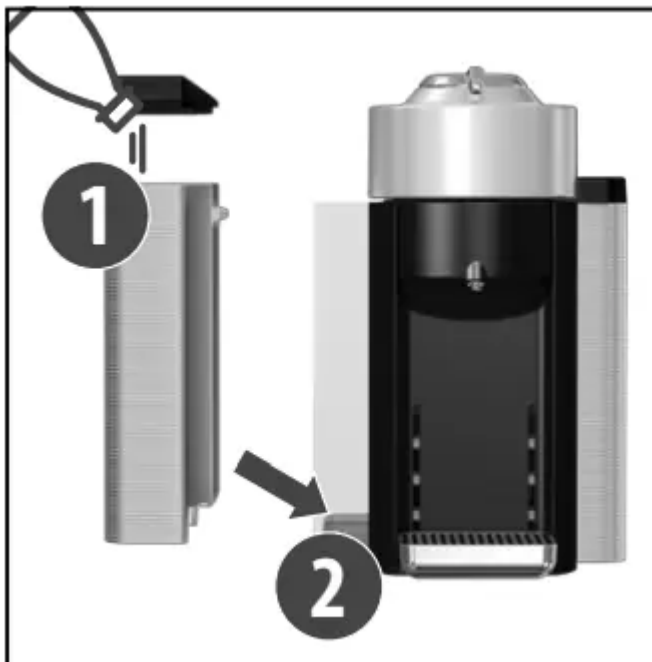

2. Rinse the cup support. Place a container of at least 13.5 fl oz./0.4 l under coffee outlet



3. Open the machine head and let the used capsule be ejected. Empty and rinse the capsule container



4. Close the head and turn lever left until “LOCKED” position.



5. Push the button 3 times within 2 seconds. The button will blink quickly during the procedure. It will take less than 2 minutes before a flow comes out. The cleaning procedure will run automatically for 5 minutes. The procedure consists of 3 cycles of pumping water in/internal cleaning/water flowing from outlet to complete

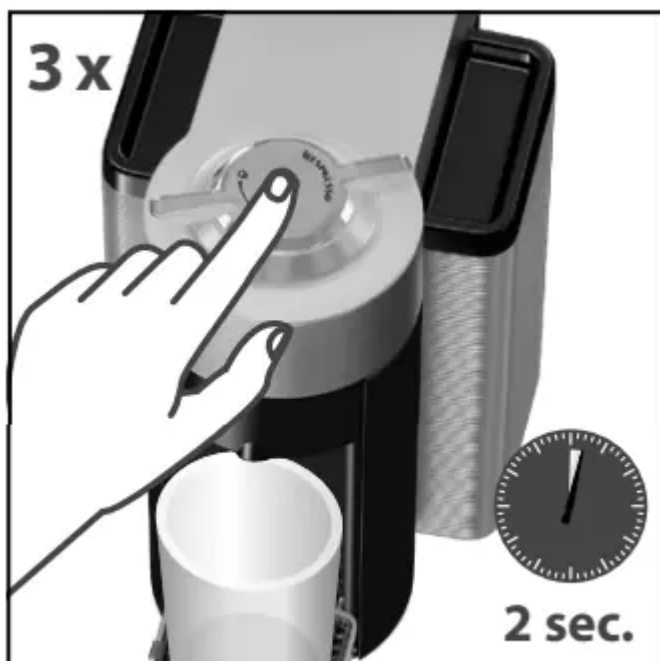

6. The procedure can be stopped at any time by pushing the button. The button will go to a steady light. In case you want to resume the cleaning process, push the button again. To brew a coffee, open the head and insert a capsule, then close, lock the machine by turning the lever left and push the button

CAUTION: do not use any strong or abrasive cleaning agent or solvent cleaner. Do not put in a dishwasher. Never immerse the appliance or part of it in water. Clean the coffee outlet regularly with a clean damp cloth. Please use only clean tools for cleaning the machine

DESCALING

NOTE:duration: approximately 20 minutes

CAUTION: read the important safeguards on the descaling package. The descaling solution can be harmful. Avoid contact with eyes, skin and surfaces. Never use any product other than the Nespresso descaling kit available through the Nespresso Club to avoid damage to your machine. For any additional questions you may have regarding descaling, please contact your Nespresso Club.

1. Turn the machine "ON" by pushing the button. Blinking light: heating up.
Steady light: ready
2. Open the machine head and let the used capsule be ejected.



3. Reclose the machine and leave the lever in “UNLOCKED” position: towards the front of the machine



4. Empty the cup support and the used capsule container
5. Fill the water tank with 1 unit of Nespresso descaling liquid and add 17 fl oz./0.5 l of water
6. To enter the descaling mode, hold the button for at least 7 seconds

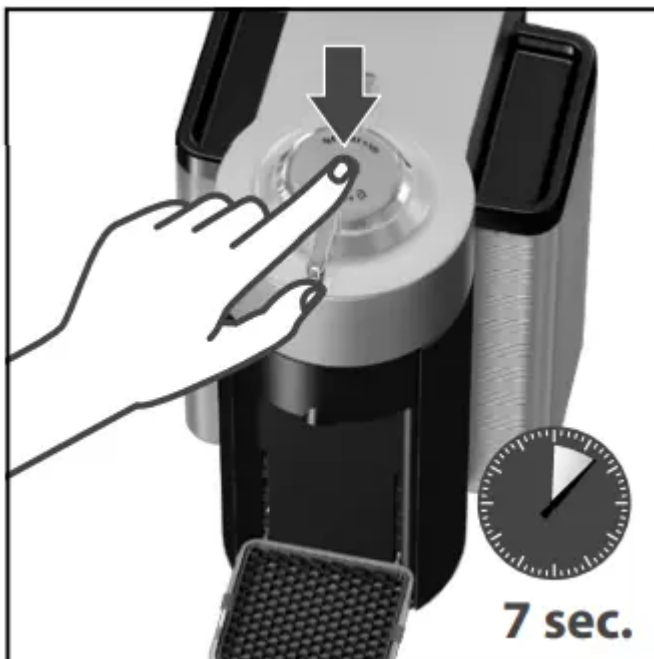

7. The button will start blinking rapidly. You now have 45 seconds to confirm you want to enter descaling mode.



8. Follow the next step to do so otherwise the machine will return to the ready for brewing coffee mode
9. Lock the machine by turning the lever left to the lock symbol on the machine head and unlock by turning right. Hold the button again for at least 7 seconds in “UNLOCKED” position.

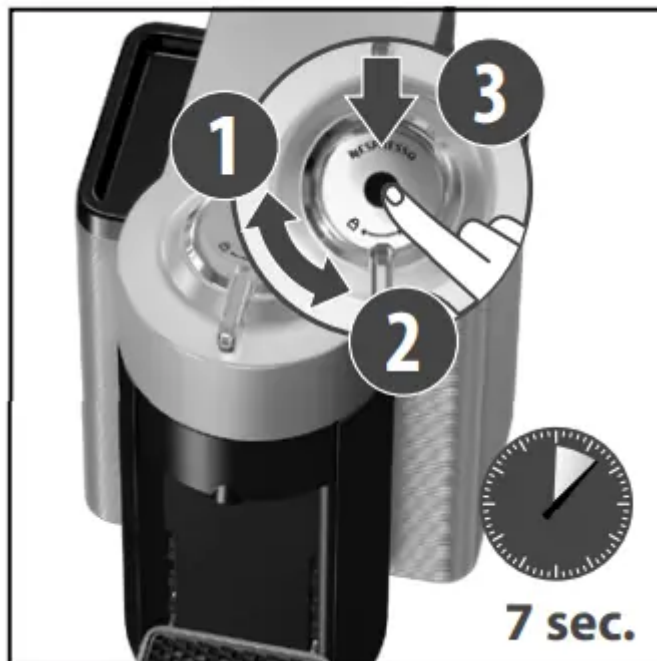

10. Place a container (minimum volume: 20 fl oz./ 0.6 l) under the coffee outlet.



11. Place a container (minimum volume: 20 fl oz./ 0.6 l) under the coffee outlet.

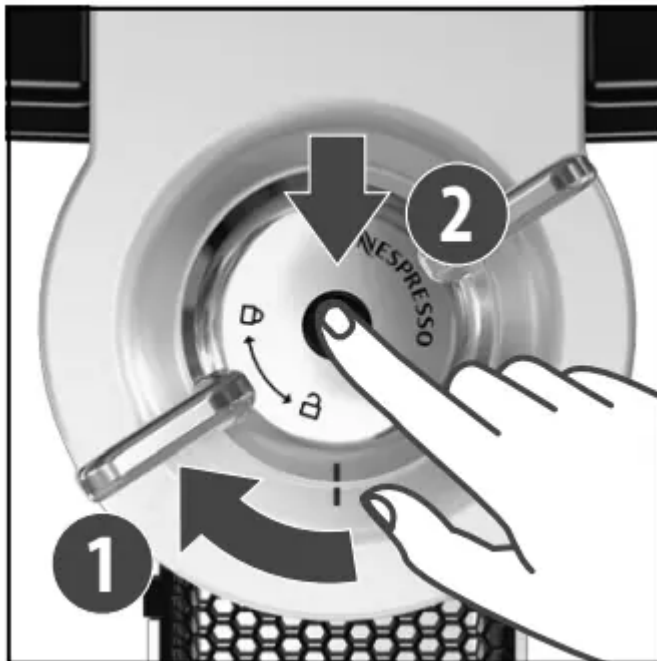

12. Empty, rinse and clean the water tank and cup support thoroughly

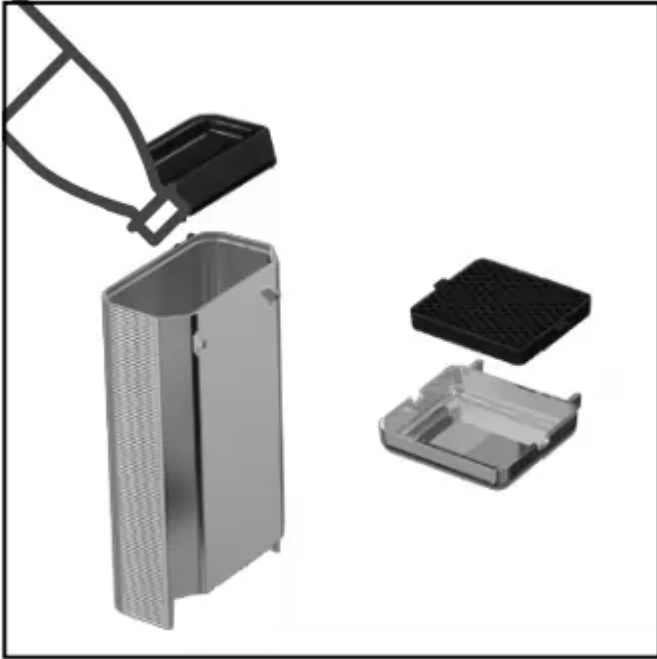

13. Fill the water tank with fresh potable water and put it back in place on the machine.

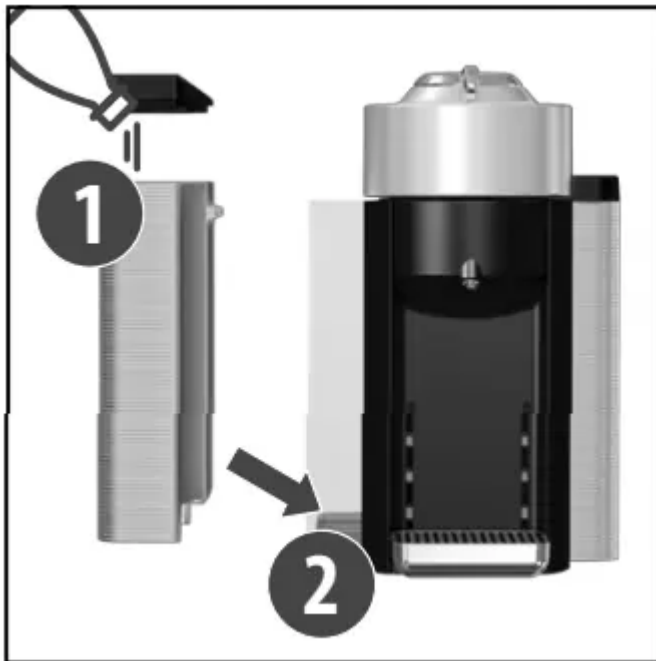

14. When ready, push the button to rinse the machine. The machine will stop automatically when complete. The procedure can be stopped at any time by pushing the button.



15. To exit the descaling mode, hold the button for at least 7 seconds.



16. The button will stop blinking rapidly and become steady





































17. Descaling is completed. Allow the machine to dry for 10 minutes before using it.

18. The machine is now ready for use

This machine is equipped with a descaling alert: the light will blink alternately 3 times, then become steady. Machine can only be operated to make coffee a few more times once the alert appears before descaling becomes mandatory.







NOTE: if the machine is completely scaled, the descaling program may not function and the machine will stop and blink. Pause the program in this case for several minutes, allowing the descaling agent to penetrate the scale build-up, then push the button again to restart the descaling

BLINKING SUMMARY

DESCRIPTION	INDICATION (→ troubleshooting/dépannage)
No light on the button Bouton éteint	Machine OFF → see points 1 & 10* Machine éteinte → Voir points 1 & 10* 
Steady illuminated button Bouton allumé constant	Ready mode Machine prête 
Regular blinking: once/second Clignotement régulier: une fois/seconde	Coffee preparation → see point 6 Préparation du café → voir point 6  ...
Blinks quickly: twice/second Clignotement rapide: 2 fois/seconde	Cleaning mode → see point 6* Nettoyage → voir point 6*    ...
Blinks rapidly: three times/second Clignotement très rapide: 3 fois/seconde	Descaling/Emptying → see point 6* Détartrage/Vidange → voir point 6*      ...
Pulse up: lighting up to steady ON, then OFF... Pulsation montante: s'allume lentement, puis s'éteint...	Heating up → see point 7* Préchauffage → voir point 7*     ...
Pulse down: fading to OFF, then ON... Pulsation descendante: s'éteint lentement, puis se rallume...	Cooling down after overheating → see point 7* Refroidissement après une surchauffe → voir point 7*     ...
Blinks rapidly twice, then long OFF... Double clignotement très rapide, puis s'éteint...	Error → see points 7 & 8* Erreur → voir points 7 & 8*     
Button ON for 1.5 second, then OFF for 0.5 second... Bouton allumé pour 1.5 secondes, puis éteint pour 0.5 seconde...	Water tank is empty → see point 5* Réservoir d'eau vide → voir point 5*    ...
Blinks 5 times in 10 seconds Clignotement 5 fois en 10 secondes	Reset to factory settings Retour aux paramètres d'usine    ... 10"
Light alternately blinking 3 times and then steady on. Clignotement alternatif 3 fois avant de se stabiliser.	Descaling alert → see point 11* Alerte de détartrage → voir point 11*       ...
	 0 1" 2"

SPECIFICATIONS

Vertuo ENV135

	120 Volts, 60 Hertz, 1350 Watts (USA/CA)
	~11 lb (~5 kg)
	40 fl oz.* (1.2 L*) / 54 fl oz.* (1.6 L*)
	7.9 in* 200 mm*
	9.0 in* 228 mm*
	12.2 in 310.5 mm
	12.3 in 313.2 mm

* Depending on model

* Selon le modèle



TROUBLESHOOTING



<p>1. No light on the button</p>	<p>→The machine has turned “OFF” automatically; push the button or “UNLOCK” the machine.</p> <p>→ Check the outlet, plug, voltage, and fuse.</p>
<p>2. No coffee, no water.</p>	<p>→Check that the water tank is filled.</p> <p>→ Check that a fresh capsule is inserted in correct position, that the lever is properly locked and push the button to start.</p> <p>→Descale if necessary.</p> <p>→Open the machine head and let the capsule be ejected. Then perform a cleaning as per cleaning section.</p>
<p>3.Coffee is not hot enough.</p>	<p>→Preheat cup with hot water from the tap.</p> <p>→Descale if necessary.</p>
<p>4. The machine doesn't start and has light steady on. If blinking, see next points.</p>	<p>→Check that lever is properly locked.</p> <p>→If you want to brew a Coffee or Espresso, check that a fresh capsule is inserted in correct position, that the lever is properly locked and push the button to start.</p> <p>→If you are cleaning, descaling or emptying the system, check that no capsule is inserted then close, lock the machine and push the button to start one of these operations.</p>
<p>5.The machine doesn't start and light blinks alternately; 1 blink and 1 pause.</p>	<p>→Fill the water tank and push button to start.</p> <p>→Check that lever is properly locked.</p>

<p>6.Light blinks while machine is running</p>	<p>→If coffee is flowing normally, this indicates the machine is working properly.</p> <p>→If only water is flowing, the machine is executing a user request for either cleaning, descaling or emptying the system. Refer to the corresponding paragraph in this user manual.</p> <p>→If there is no intention to clean, descale, or empty the system, then push the button to stop the machine. If the machine is still blinking, exit descaling mode by holding the button for at least 7 seconds or refer to next section.</p> <p>→If problem persists, call the Nespresso Club</p>
<p>7.Light blinks and machine is not running.</p>	<p>→It will take some time before the coffee flow comes out (due to barcode reading and pre-wetting the coffee).</p> <p>→Check that a fresh capsule is inserted in correct position, that the lever is properly locked and push the button to start.</p> <p>→ Fill the water tank and push button to start.</p> <p>→Turn the machine to “OFF mode” by pushing the button for 3 seconds and then push it again to turn the machine “ON”. Now wait approximately 20 minutes to allow the machine to cool down after extensive use.</p> <p>→If the machine doesn’t turn “OFF” then exit descaling mode by pushing the button for at least 7 seconds.</p>
<p>8.Light blinks alternately 2 blinks and 1 pause continuously. Machine is not running.</p>	<p>→During regular Coffee/ Espresso preparation : 1) Unlock the lever and open the machine head to check that a fresh undamaged capsule is inserted in the correct position; 2) Check that the lever is in “LOCKED” position 3) Check that the water tank is filled.</p> <p>→During Descaling, Emptying and Cleaning: 1) Check that capsule is ejected 2) Check that the lever is in “LOCKED” position.</p> <p>→During Programming Volume: 1) Check if a capsule has been well inserted 2) Please refer to the corresponding chapter</p> <p>→ If problem persists:</p> <ol style="list-style-type: none"> 1. Unlock the lever and open machine head. 2. Replace capsule (if needed). 3. Disconnect powercord from the outlet and plug the machine back into outlet after 10 seconds.

	4. Close the head and press the button to turn "ON" and press again to start brewing. If problem persists, call the Nespresso Club.
9. Leakage or unusual coffee flow.	→Check that the water tank is well positioned.
10. Machine turns to "OFF" mode.	→To save energy the machine will turn off after 9 minutes of non-use. →See paragraph on "Energy Saving Concept".
11. Light alternately blinking 3 times and then steady on	→Descaling needed: machine can be operated when alert appears only a few times after this alert before descaling becomes necessary.
12. Coffee grounds in the cup	→ Perform the cleaning procedure twice. →See paragraph on "Cleaning".

Warning

This content is compiled from multiple sources and is provided for reference purposes only. It may not be complete or fully applicable to all situations. If you are unable to resolve your issue, please contact the product manufacturer or an authorized service provider for official support.