

FEATURES AND BENEFITS

KEY PARTS AND COMPONENTS

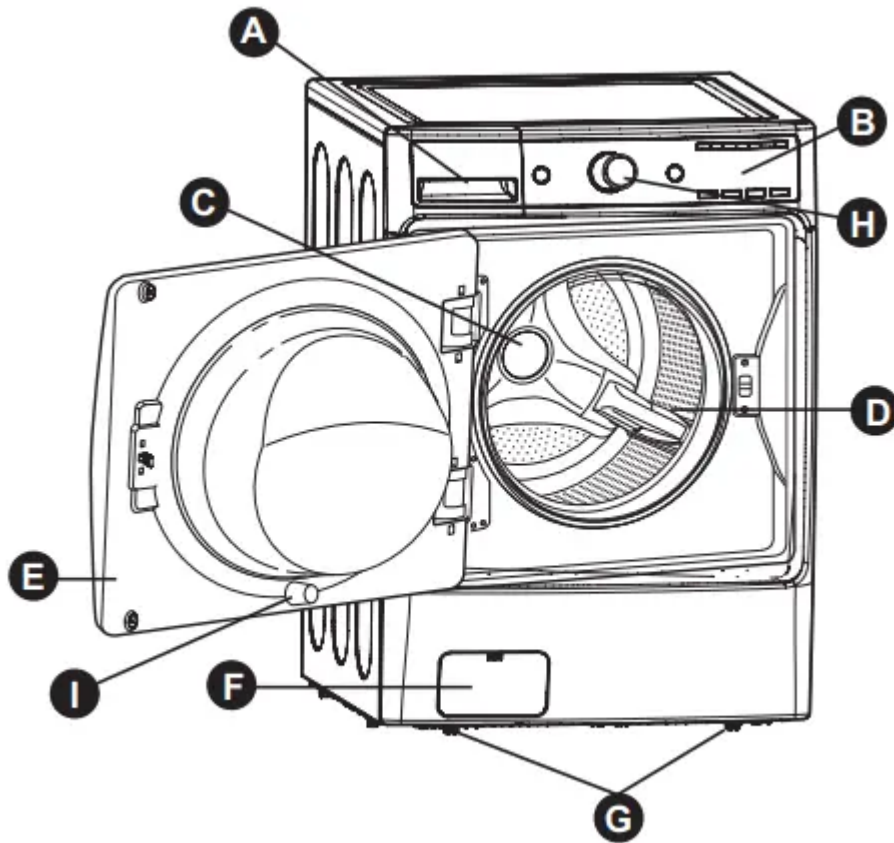

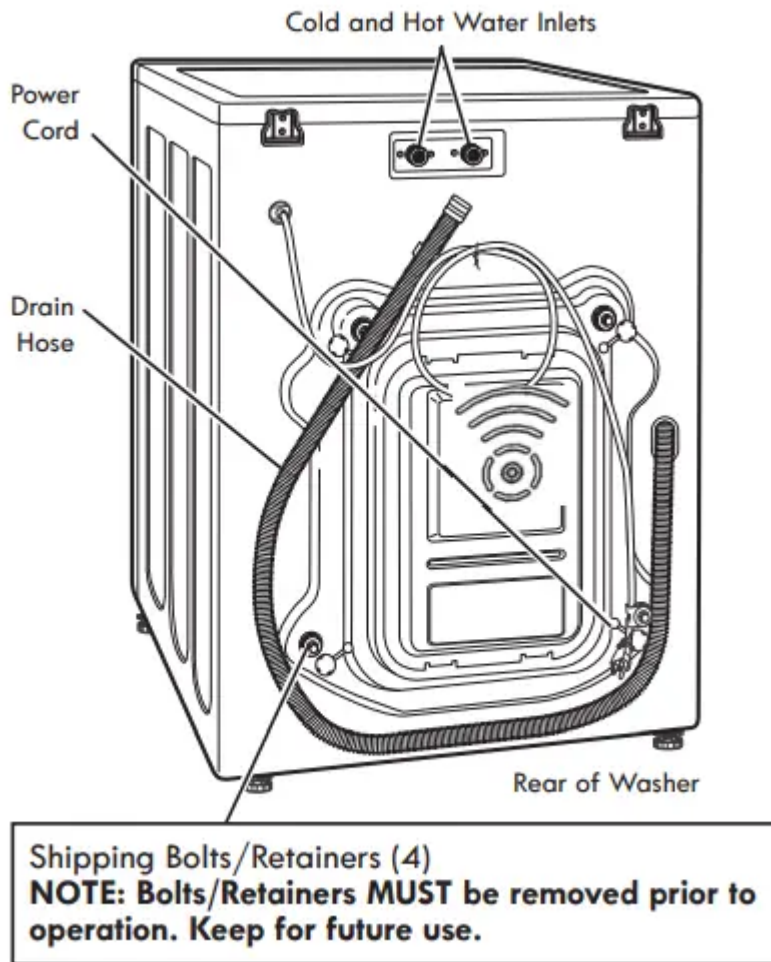

A. DETERGENT DISPENSER: There are four compartments. One each for prewash, main wash, liquid bleach, and liquid fabric softener.

B. CONTROL PANEL WITH LED DISPLAY: The easy-to-read LED display shows cycle options, settings, cycle status, and estimated time remaining during operation. NOTE: Sensors in the washer automatically detect the size of the wash load to optimize washing time, based on the selected cycle and options.

C. DIRECT-DRIVE MOTOR: The direct-drive motor provides improved performance and reliability while increasing energy efficiency. (Motor is not visible.)

D. LARGE-CAPACITY STAINLESS STEEL DRUM: The ultra-large stainless steel drum offers extreme durability and is tilted to improve efficiency and allow easier access for large items.

E. EASY-ACCESS LOCKING DOOR: The extra-large door locks during operation. The door will not open until it is safe to do so.

F. FILTER ACCESS PANEL: Provides easy access to the drain pump filter, which allows you to clean the filter or retrieve lost items without a service call.

G. LEVELING FEET: Four leveling feet (two in the front and two in the back) adjust to improve washer stability on uneven floors. Feet are adjusted and locked in place using the adjusting wrench included with the washer.

H HIGH-EFFICIENCY STEAM CYCLES: During high-efficiency steam cycles, hot steam interacts with fabrics to help remove tough stains.

I DOOR MAGNET: Safely and conveniently keeps the door ajar. There are two door closed positions, fully closed and slightly ajar. In the latter position, the door is only closed to the door magnet to keep the door slightly open when the washer is not in use. This will promote air circulation and allow the interior of the machine to dry. To use this feature, close the door just until it contacts the door magnet.

HOW TO USE

WARNING: To reduce the risk of fire, electric shock, or injury to persons, read and follow this entire Use & Care Guide, including the Important Safety Instructions, before operating this washer.

CONTROL PANEL FEATURES

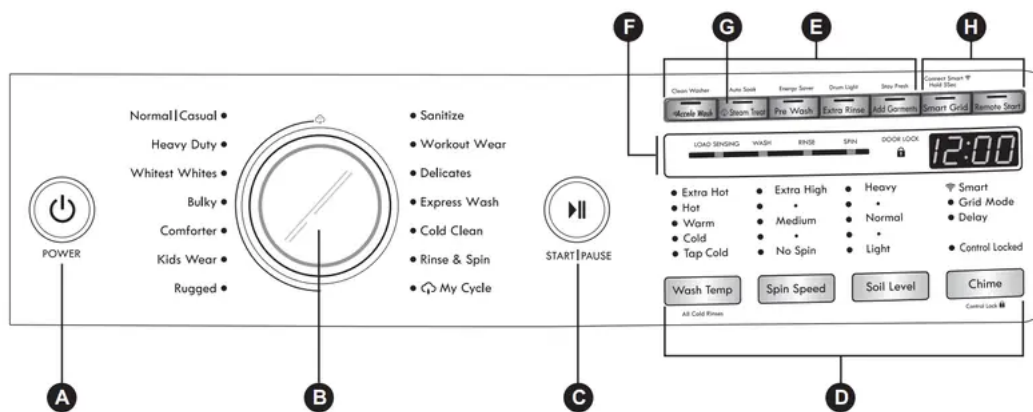

A. POWER (ON/OFF) BUTTON: Press to turn the washer ON or OFF.

NOTE: Pressing the POWER button during a cycle will cancel that cycle and any load settings will be lost. The door will unlock after a brief pause, unless the water level or temperature is too high.

B. CYCLE SELECTOR KNOB: Turn this knob to select the desired cycle. Once the desired cycle has been selected, the standard presets will appear in the display. These settings can be adjusted using the cycle setting buttons any time before starting the cycle.

C. START/PAUSE BUTTON: Press this button to start the selected cycle. If the washer is running, use this button to pause the cycle without losing the current settings.

NOTE: If you do not press the START/PAUSE button within one hour of selecting a cycle, the washer automatically turns OFF.

D. CYCLE MODIFIER BUTTONS: Use these buttons to adjust the settings for the selected cycle. The settings light up above the buttons to show the current selection.

E. SPECIAL CYCLE AND OPTION BUTTONS: These buttons are used to activate special cycles or options.

F. TIME AND STATUS DISPLAY: The display shows the cycle status, door lock status and estimated time remaining.

G. STEAM TREAT BUTTON: Select the STEAM TREAT button to add steam to the selected cycle for added cleaning power.

NOTE: The steam option is not available on all cycles.

H. SMART FEATURES: The Remote Start and Smart Grid features allow you to control your washer remotely with a smart phone and to lower energy costs by avoiding peak usage times, respectively. See page 24 in this guide and the booklet shipped with your washer for more information.

OPERATING THE WASHER

1. SORT LAUNDRY AND LOAD WASHER: Sort laundry by fabric type, soil level, color and load size, as needed. Open the door and load selected items into the washer.



2. TURN ON THE WASHER: Press the POWER button to turn ON the washer. The lights around the cycle selector knob will illuminate and a chime will sound.



3. SELECT A CYCLE: Turn the cycle selector knob in either direction to select the desired cycle. The preset Wash Temperature, Spin Speed, Soil Level, and Option settings for that cycle will be shown.

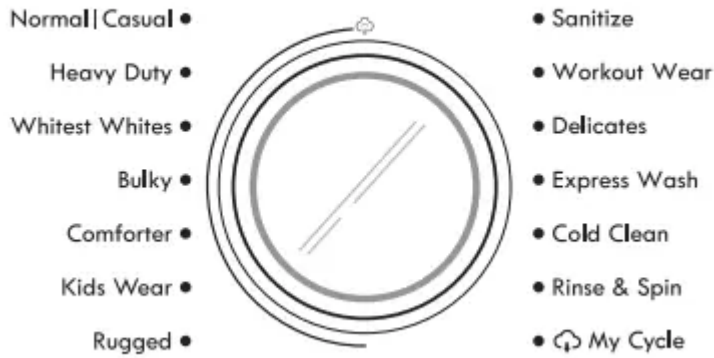

4. SELECT CYCLE MODIFIERS: Default settings for the selected cycle can now be changed if desired. Use the cycle modifier buttons. NOTE: To protect your fabrics, not all modifiers are available on all cycles.

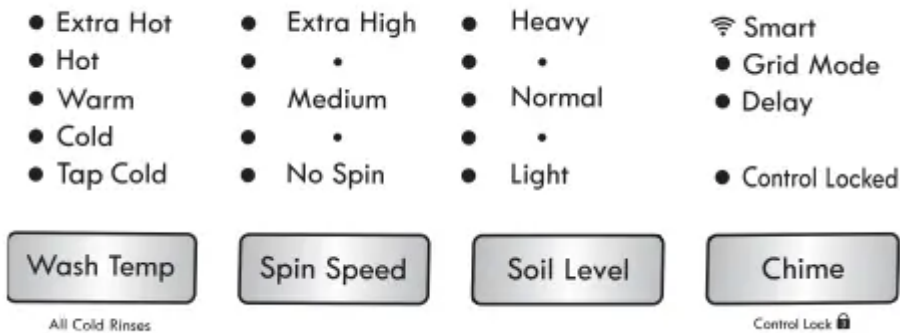

5. SELECT CYCLE OPTIONS: Cycle options can be added using the option buttons.

NOTE: Not all options are available on all cycles. A different chime will sound and the LED will not come on if the selection is not allowed.



6. ADD DETERGENT: Add High-Efficiency (HE) detergent to the detergent dispenser drawer. For proper wash performance, always measure the detergent using the measuring device provided by the detergent manufacturer.



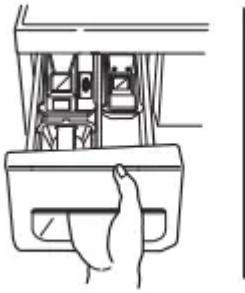

7. **BEGIN CYCLE:** Press the **START/PAUSE** button to begin the cycle. The door will lock, the washer will briefly tumble the load without water to measure its weight, and then the washer will begin the selected wash cycle. Pressing the **START/PAUSE** button will pause the cycle and the door will unlock. Press the **START/PAUSE** button again to resume the wash cycle.



CYCLE GUIDE

The cycle guide below shows the default settings, available options and recommended fabric types for each cycle. Allowable modifier adjustments are shown below the default setting for each cycle.

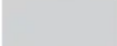
-  = Available Option
-  = Default Setting

Cycle	Fabric or Load Type	Load Sensing	Wash Option	Wash Temp.	Spin Speed	Soil Level	Accela Wash	Steam Treat	Pre Wash	Extra Rinse	Stay Fresh	Auto Soak	Energy Saver
Normal/Casual	Cotton, linen, towels, shirts, sheets, jeans, mixed loads.	Yes	Yes	Warm	• (High)	Normal							
				Extra Hot Hot Cold Tap Cold	Extra High Medium • (Low)	Heavy Light	●	●	●	●	●	●	●
Heavy Duty	Heavily soiled cotton fabrics.	Yes	Yes	Warm	Extra High	Heavy							
				Extra Hot Hot Cold Tap Cold	• (High) Medium • (Low)	Normal Light	●	●	●	●	●	●	●
Whitest Whites	Heavily to normally soiled white cottons.	Yes	Yes	Hot	• (High)	Normal							
				Warm Cold Tap Cold	Extra High Medium • (Low) No Spin	Heavy Light	●	●	●	●	●	●	
Bulky	Large items such as blankets and comforters.	No	Yes	Warm	Medium	Normal							
				Hot Cold Tap Cold	• (Low) No Spin	Heavy Light	●	●	●	●	●	●	
Comforter	Comforters, blankets, rugs.	No	Yes	Warm	• (High)	Normal							
				Hot Cold Tap Cold	Medium • (Low) No Spin	Heavy Light	●	●	●	●	●	●	
Kids Wear	Specially designed to clean and thoroughly rinse kids wear.	Yes	Yes	Hot	• (High)	Heavy							
				Warm Cold Tap Cold	Extra High Medium • (Low) No Spin	Normal Light		●	●	●	●	●	
Rugged	Heavily soiled hard and thick items such as jeans and construction work wear.	Yes	Yes	N/A	• (High)	N/A							
					Extra High Medium • (Low) No Spin			●		●	●		

*CERTIFIED BY NSF: NSF International (formerly the National Sanitation Foundation), certifies that this wash cycle reduces 99.9% of bacteria on laundry through high temperature, when used with powdered detergent.

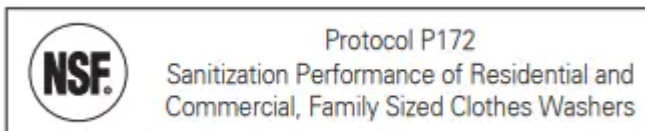

NOTE:

- To protect your garments, not every wash temperature, spin speed, soil level, or option is available with every cycle. A chime will sound and the LED will not light if the selection is not allowed.
- The washer automatically adjusts the wash time for the amount of laundry, water pressure, water heating time and other operating conditions.
- These cycles use various wash motions to enhance cleaning and/or fabric care performance. The wash motions may sound different at different stages of the wash cycle. This is normal.
- The recommended load size for the Sanitize cycle is 10 lb. (4.5 kg).
- When the Accela Wash option is selected, the drum spins to rinse the clothes. To use the No Spin option, you must deselect the Accela Wash option.



Cycle	Fabric or Load Type	Load Sensing	Wash Option	Wash Temp.	Spin Speed	Soil Level	Accela Wash	Steam Treat	Pre Wash	Extra Rinse	Stay Fresh	Auto Soak	Energy Saver
Sanitize*	Heavily soiled items such as work clothes, diapers, etc.	Yes	Yes	Extra Hot	• (High)	Normal							
					Extra High Medium • (Low) No Spin	Heavy Light	●	●	●	●	●	●	
Workout Wear	Permanent press, synthetic items.	No	Yes	Warm	Medium	Normal							
				Cold Tap Cold	• (Low) No Spin	Heavy Light			●	●	●		
Delicates	Dress shirts, blouses, nylons, sheer or lacy garments.	No	Yes	Cold	Medium	Normal							
				Warm Tap Cold	• (Low) No Spin	Heavy Light			●	●	●	●	
Express Wash	Lightly soiled clothing and small loads.	No	Yes	Hot	Extra High	Light							
				Warm Cold Tap Cold	• (High) Medium • (Low) No Spin	Normal Heavy	●			●	●		
Cold Clean	Small loads of cotton, linen, towels, shirts, sheets, jeans, mixed loads.	Yes	Yes	Cold	• (High)	Normal							
				Tap Cold	Extra High Medium • (Low) No Spin	Light			●	●	●	●	
Rinse & Spin	Loads that only need to be rinsed.	No	No	Cold	• (High)	N/A							
					Extra High Medium • (Low) No Spin				●	●			
My Cycle (Default: Small Load)	For downloadable cycles.	Yes	Yes	Warm	• (High)	Normal							
				Hot Cold Tap Cold	Extra High Medium • (Low) No Spin	Heavy Light			●	●	●		







SORTING WASH LOADS

Fabric Care Labels

Many articles of clothing include a fabric care label. Using the chart below, adjust the cycle and option selections to care for your clothing according to the manufacturer's recommendations.

Fabric Care Labels



Machine wash cycle

		
Normal	Permanent press/ wrinkle resistant	Gentle/ delicate
		
Hand wash	Do not wash	Do not wring

Water temperature

●●●	●●	●
Hot	Warm	Cold/cool

Bleach symbols

		
Any bleach (when needed)	Only non-chlorine bleach (when needed)	Do not bleach

Grouping Similar Items

- For the best washing results, and to reduce the possibility of damage to clothing, care should be taken to sort the clothing into loads that are made up of similar items. Mixing different fabric types and/or soil levels can result in poor wash performance, color transfer or discoloration, fabric damage or linting. Fabrics should be sorted into groups as described below.
- Colors: Sort articles by color. Wash dark clothes together in a separate load from light colors or whites. Mixing dark clothes with light clothes can result in dye transfer or discoloration of the lighter clothes.
- Soil Level: Wash heavily soiled clothing together. Washing lightly soiled clothing in the same load with heavily soiled clothing could result in poor wash performance for the lightly soiled clothing.
- Fabric Type: Delicate articles should not be mixed with heavier or sturdier fabric types. Washing delicates in a load with heavy fabrics can result in damage to the more delicate fabrics. Washing heavier fabrics in a delicate load can result in poor wash performance for the heavier fabrics and possible damage to the delicates.
- Lint Type: Some fabrics attract and bind lint to them while others give off lint in the laundry process. Avoid mixing these lint collectors and lint producers in the same load. Mixing these fabrics will result in pilling and linting on the lint collectors. (For example, lint collector – knit sweater; lint producer – terrycloth towels.)

Loading the Washer

- Check all pockets to make sure that they are empty. Items such as clips, matches, pens, coins, and keys can damage both your washer and your clothes.
- Close zippers, hooks, and drawstrings to prevent these items from snagging or tangling on other clothes.
- Pretreat heavily stained areas for best results.
- Combine large and small items in a load. Load large items first.
- Large items should not be more than half of the total wash load.
- The drum should not be tightly packed with items. The door of the washer should close easily.
- To prevent an out-of-balance load, do not wash single items. Add one or two similar items to the load. Large, bulky items, such as a blanket, comforter, or bedspread, should be washed individually.
- Do not wash or spin waterproof items, such as rain coats, sleeping bags, etc.
- When unloading the washer, check under the door seal for small items.

NOTE: Make sure that the door seal area is clear when closing the door. Overloading the washer can cause items to get caught between the door and the seal. This can damage both the items and the seal.



- **DO NOT OVERLOAD THE DRUM**
- **MAKE SURE CLOTHING IS NOT CAUGHT IN THE DOOR GASKET**

Sort Laundry...			
by Colors	by Soil	by Fabric	by Lint
Whites	Heavy	Delicates	Lint Producer
Lights	Normal	Easy Care	Lint Collector
Darks	Light	Sturdy	

- For best performance, load clothes as shown.

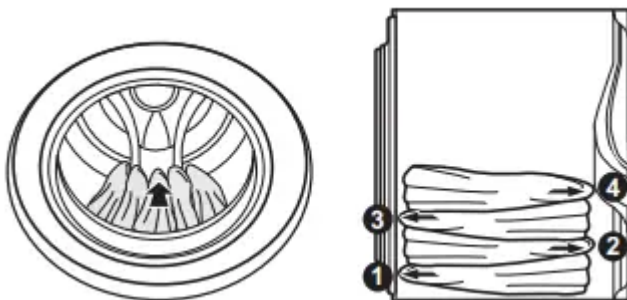

- Load clothes loosely, and do not overfill the drum. Clothes need room to circulate in order to get clean.
- Do not press down on items while stacking them in the drum.

ABOUT THE DISPENSER DRAWER

The automatic dispenser consists of four compartments which hold:

- Liquid chlorine bleach.
- Liquid fabric softener.

- Liquid or powdered detergent for prewash.
- Liquid or powdered detergent and color-safe bleach for main wash.

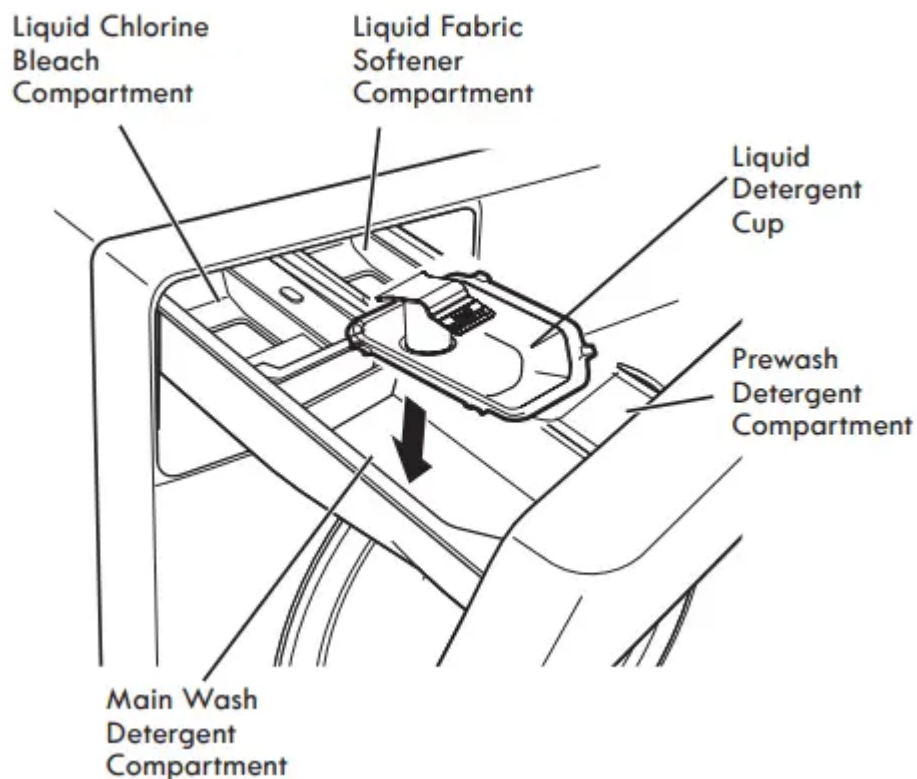

Pre-Wash Detergent Compartment

- Add liquid or powdered detergent to this compartment when using the Pre-Wash option. Always use HighEfficiency (HE) detergent with your washing machine.
- The amount of detergent added for the Pre-Wash option should be $\frac{1}{2}$ the amount recommended for the main wash cycle. For example, if the main wash cycle requires $\frac{1}{2}$ measure of detergent, add $\frac{1}{4}$ measure to the Pre-Wash compartment.

NOTE: If using liquid detergent for the main wash when using the Pre-Wash option, the liquid detergent cup accessory must be used in the main wash dispenser. This will prevent the main wash liquid detergent from being dispensed immediately.

Main Wash Detergent Compartment

- This compartment holds laundry detergent for the main wash cycle. The detergent is added to the load at the beginning of the cycle. Always use High-Efficiency (HE) detergent with your washing machine. Either powdered or liquid detergent may be used.
- Never exceed the manufacturer's recommendations when adding detergent. Using too much detergent can result in detergent buildup in clothing and the washer.

NOTE: Liquid or powdered color-safe bleach may be added to the main wash compartment with detergent of the same type. DO NOT add liquid or powdered color-safe bleach to the bleach dispenser. DO NOT mix liquid and powdered cleaning agents within the same compartment.

Liquid Bleach Compartment

This compartment holds liquid chlorine bleach, which is dispensed automatically at the proper time during the wash cycle.

- Do not add powdered or liquid color-safe bleach to this compartment. The bleach compartment is designed to dispense liquid chlorine bleach only. Powdered or liquid color-safe bleach will not dispense properly.
- Always follow the manufacturer's recommendations when adding bleach. Do not exceed the maximum fill line since this can cause the bleach to be dispensed immediately, causing damage to fabrics. Using too much bleach can damage fabrics.
- Never pour undiluted liquid chlorine bleach directly onto the load or into the drum. Fabric damage can occur.

Fabric Softener Compartment

This compartment holds liquid fabric softener, which is automatically dispensed during the final rinse cycle.

Never exceed the manufacturer's recommendations when adding softener. Using too much fabric softener can result in buildup in clothing and the washer. Either powdered or liquid fabric softener may be used.

- Always follow the manufacturer's recommendations when adding fabric softener. Do not exceed the maximum fill line. Using too much fabric softener may stain clothes.
- Dilute concentrated fabric softeners with warm water. Do not exceed the maximum fill line.
- Never pour fabric softener directly onto the load or into the drum.

DETERGENT AND DISPENSER USE

A Word About Detergents

High-Efficiency (HE) detergents produce fewer suds, dissolve more efficiently to improve washing and rinsing performance, and help to keep the interior of your washer clean. Using detergent that is not HE may cause oversudsing and unsatisfactory performance which could result in error codes, cycle failure, and machine damage.

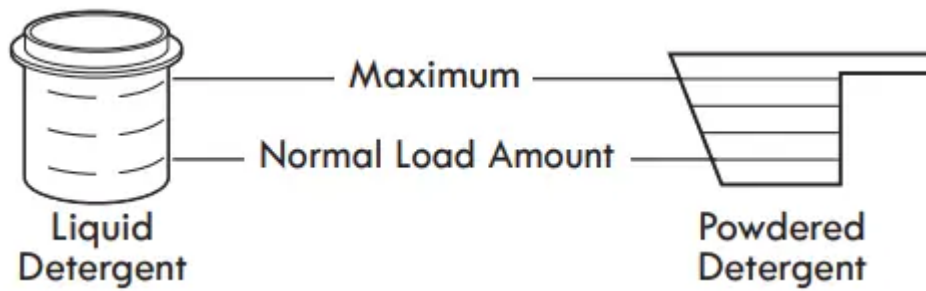

For proper wash performance, always measure the detergent using the measuring device provided by the detergent manufacturer.

- The normal amount of HE detergent needed, for average loads, is less than $\frac{1}{2}$ of the recommended maximum. Use less detergent for soft water, light soil or smaller loads. Never use more than the maximum amount recommended by the detergent manufacturer.



Designed to use only High-Efficiency (HE) detergent

IMPORTANT: Your washing machine is designed for use with only High-Efficiency (HE) detergents. HE detergents are formulated specifically for front-load washers and contain suds-reducing agents. Always look for the HE symbol when purchasing detergent.

IMPORTANT: Not all detergents are the same. Pay careful attention to the amount of detergent used to avoid oversudsing, poor rinsing and detergent buildup in clothing, and residue buildup that can contribute to odors in the machine. **NEVER** use a cup or scoop other than the one supplied by the manufacturer of the detergent you are using. Never use more than the maximum amount of detergent recommended by the manufacturer.

- Always measure the detergent amount. While HE detergents are designed for this type of washing machine, be careful when measuring the detergent. For most normal loads, no more than $\frac{1}{4}$ to $\frac{1}{2}$ of cap or scoop of HE detergent should be used.

NOTE: Extra care must be exercised when using 2X and 3X concentrated detergents because even a little bit extra can contribute to the problems mentioned above.

NOTE: Detergents designated as HE compatible may not provide optimal results.

Filling the Dispenser

To add detergent, bleach, and fabric softener to the automatic dispenser:

1. Open the dispenser drawer.
2. Load the laundry products into the appropriate compartments.
3. Close the drawer before starting the cycle.

NOTE: It is normal for a small amount of water to remain in the bleach and softener compartments at the end of the cycle.

IMPORTANT: Do not place or store laundry products, such as detergent, bleach, or liquid fabric softener, on top of your washer or dryer. Wipe up any spills immediately.

These products can damage the finish and controls

TIME AND STATUS DISPLAY

The time and status display shows the estimated time remaining, cycle progress, and door lock status.

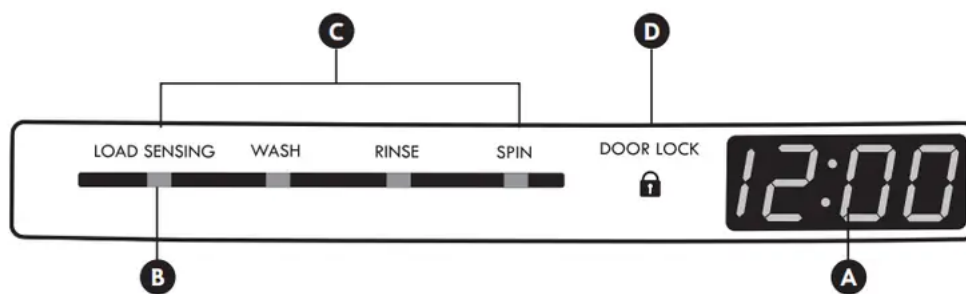

A. ESTIMATED TIME REMAINING: When the START/PAUSE button is pressed, the washer will automatically detect the load size for cycles that use load sensing. The control will then optimize the wash and rinse times, based on the selected cycle, modifiers and options. When the load size has been determined, the display will change from dashes (- - -) to the estimated time for that cycle. For non-load sensing cycles, the estimated time will display when the cycle is selected.

NOTE:

- The time shown is only an estimate. For example, the time displayed may pause for a period of time while the machine is heating the water or balancing the load. Under certain conditions, the machine can pause for extended periods of time.
- Estimated time is based on normal operating conditions. Several external factors (load size, room temperature, incoming water temperature, etc.) also affect the length of estimated time vs. actual time.

B. LOAD-SENSING INDICATOR: At the beginning of cycles that use the load sensing feature, the LOAD SENSING light will blink while the load size is being measured. Once the size has been determined, the control adjusts the cycle for optimum performance. Estimated time remaining will not display until the load size has been determined, and may be different for each load.

C. CYCLE STATUS INDICATOR: These status LEDs illuminate to indicate which stage of the cycle is currently running. A blinking light indicates the active stage of the cycle. When that stage is complete, the light will remain steady.

D. DOOR LOCK INDICATOR: Indicates that the door is locked. The washer door will lock while the washer is operating. The door can be unlocked by pressing START/PAUSE to pause the washer.

NOTE:

- If the temperature in the washer is too high, the door cannot be unlocked until the washer has cooled.
- If the water level is too high, the door will not unlock. To drain the water, press POWER, then press the SPIN SPEED button without selecting a cycle. Press START/PAUSE and the water will drain and the clothes will spin out. Do not try to force the door open, as this will damage the door.

CYCLE MODIFIER BUTTONS

Each cycle has default settings that are selected automatically. You may also customize these settings using the cycle modifier buttons. Press the button for the desired modifier until the indicator light for the desired value is lit. The washer automatically adjusts the water level for the type and size of wash load for best results and maximum efficiency. Due to the high-efficiency nature of this product, water levels may be much lower than expected. This is normal operation and cleaning/ rinsing performance will not be compromised.

NOTE: To protect your garments, not every wash temperature, spin speed, soil level, or option is available with every cycle. A chime will sound and the LED will not light if a selection is not allowed

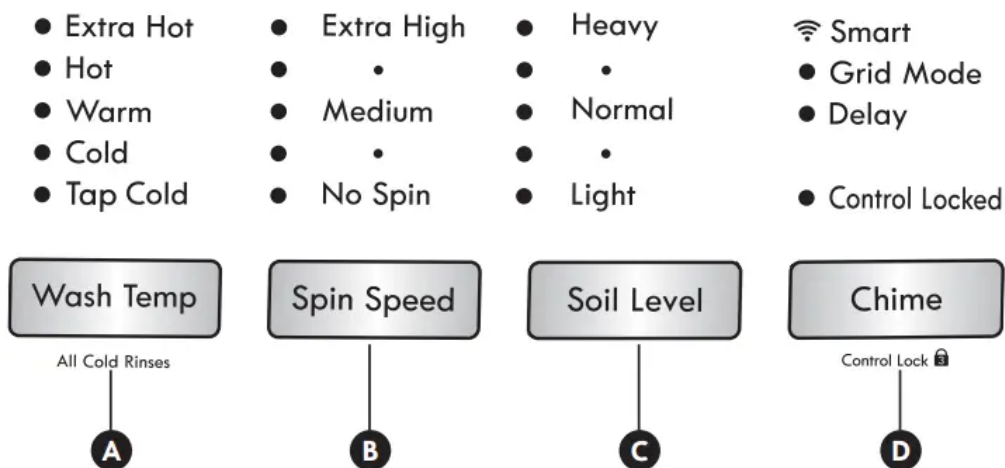

A. **WASH TEMP:** Wash Temp selects the wash and rinse temperature combination for the selected cycle. Press the Wash Temp button until the indicator light for the desired setting is lit.

- Select the water temperature suitable for the type of load you are washing. Follow the garment fabric care labels for best results.
- Cold rinses use less energy. The actual rinse temperature depends on the temperature of the cold water at the faucet.
- Cold water is used for all rinse cycles.

B. **SPIN SPEED:** Higher spin speeds extract more water from clothes, reducing drying time and saving energy. Press the SPIN SPEED button until the desired speed is selected. Some fabrics, such as delicates, require a slower spin speed. To protect your clothing, not all spin speeds are available for all cycles. The Drain & Spin cycle:

1. Press the POWER button to turn ON the washer.
2. Press the SPIN SPEED button to select the desired spin speed. For drain only, select the NO SPIN option.
3. Press the START/PAUSE button. The water will drain and the clothes will tumble before the spin routine begins.

C. **SOIL LEVEL:** Adjusting the soil level setting will modify the cycle to allow more time for heavily soiled clothes or less time for lightly soiled clothes. Press the SOIL LEVEL button until the desired soil level is selected.

D. **CHIME:** Press repeatedly to adjust the volume of the chime and keypad tones. You may turn the end-of-cycle chime and keypad tones ON or OFF with the CHIME button.

STEAM CYCLES AND OPTIONS

Your washing machine features several additional cycle options that customize cycles to meet your individual needs.

1. Turn ON the washer and turn the cycle selector knob to select the desired cycle.
2. Use the cycle modifier buttons to adjust the settings for that cycle.
3. Press the cycle option button(s) for the option(s) you would like to add. The button will light when that option is selected. For secondary functions, press and hold the button for three seconds. The LED will blink when the secondary option is selected. Both options cannot be selected together.
4. If the selected option is not allowed for the selected cycle, the chime will sound twice to alert you and the LED will not illuminate.
5. Press the START/PAUSE button to start the cycle. After a brief delay, the door will lock and the cycle will begin.

NOTE: To protect your garments, not every option is available with every cycle.

NOTE: If the START/PAUSE button is not pressed within one hour, the control will shut off and the settings will be lost.

STEAM TREAT

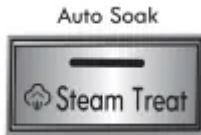

Select the STEAM TREAT button to add steam to the selected cycle for added cleaning power. Adding steam to cycles helps provide improved cleaning performance. By creating steam, fabrics get the benefit of a deep clean. The steam option is not available on all cycles.

To add steam to a cycle:

1. Turn ON the washer and turn the cycle selector knob to select a cycle that allows the steam option. Refer to the Cycle Guide to see which cycles allow steam.
2. Press the STEAM TREAT button. The washer will automatically adjust the cycle settings.
3. Set any other desired options.
4. Press the START/PAUSE button to start the cycle.

NOTE: The door may be very warm during steam cycles. This is normal. Do not attempt to override the door lock mechanism or reach into the washer during a steam cycle. Steam can cause severe burns.

IMPORTANT NOTES ABOUT STEAM CYCLES:

- Steam may not be visible during the steam cycles. This is normal.
- Do not use steam with delicate fabrics such as wool, silk, or easily discolored fabrics.

ACCELA WASH

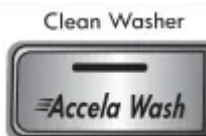

- The Accela Wash option uses a twin waterspray and detergent injection which reduces cycle time while maintaining wash performance when added to a cycle.

PRE WASH

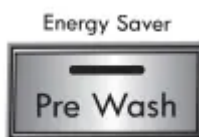

- Select this option to add a 15-minute prewash, rinse and spin cycle to the chosen cycle. This is especially useful for heavily soiled items.

EXTRA RINSE



- This option will add an extra rinse to the selected cycle. Use this option to help ensure the removal of detergent or bleach residue from fabrics.

STAY FRESH



- This feature helps keep wrinkles from setting in clothes and helps keep them fresh if they are not removed from the washer as soon as the cycle is complete. Press and hold the ADD GARMENTS button for three seconds to tumble the clothes intermittently and circulate fresh air through the drum for up to nineteen hours. Press the POWER button or the START/PAUSE button to remove clothes at any time.

DRUM LIGHT



- The drum is equipped with a blue LED light that illuminates when the washer is turned on. This light automatically turns off when the door is closed and the cycle starts. To turn on the light during a cycle, press and hold the EXTRA RINSE button for three seconds. The drum light will illuminate and then turn off automatically after four minutes.

NOTE: Clothes may appear to be yellow in the washer while the drum light is on. This effect is caused by the reflection of the light.

ADD GARMENTS



Use this function to add garments or remove foreign objects like coins or keys after the cycle has started.

1. Press ADD GARMENTS. The cycle pauses and the door unlocks.
2. Open the door, add garments or remove foreign objects, and close the door.
3. Press START/PAUSE to restart the cycle. The cycle continues automatically.

NOTE:

- After checking the water level/temperature conditions for safety, the door unlocks once the wash movement has stopped. (Door Lock LED turns off.)
 - This may take several seconds depending on the water level. When a lot of water is in the tub, the door unlocks after water drains to a safe level.
 - If the temperature in the tub is higher than 113°F (45°C), a short warning chime sounds and ADD GARMENTS is NOT allowed for safety.
- ADD GARMENTS is disabled during the CLEAN WASHER cycle for safety.
- To preserve wash performance, wash time may be extended depending on when garments are added to a cycle.

WARNING:

- Be careful when opening the door as wet laundry may drip or fall out when the door is opened.
- Do not attempt to force the door to open when locked. Doing so could result in damage to the machine, malfunction, or personal injury.
- Make sure the area around the door seal is clear before closing the door. If laundry gets caught between the door and the seal, it can damage the rubber gasket and may result in leaking.

SPECIAL FUNCTIONS

CLEAN WASHER

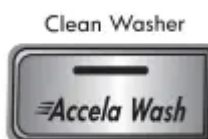

Detergent residue can build up in the wash drum over time and can lead to a mildewy or musty smell. The CLEAN WASHER cycle is specially designed to remove this buildup using bleach or

another cleaner designed specifically for cleaning front load washers. Run the CLEAN WASHER cycle once a month, or more often under heavy use conditions or if odor is present. See complete instructions in the CARE AND CLEANING section.

1. Turn ON the washer and press and hold the ACCELA WASH button for three seconds. Selecting any other cycle after CLEAN WASHER has been selected will cause the CLEAN WASHER cycle to be cancelled.
2. Fill the bleach dispenser to the MAX line with liquid chlorine bleach. Do not overfill the bleach dispenser. Overfilling will cause the bleach to dispense immediately. NOTE: For other drum cleaning products, follow the cleaner manufacturer's instructions and recommendations. For powdered cleaning products, add the cleaner to the main wash compartment of the dispenser drawer. Place tablet cleaners directly into the drum.
3. Press the START/PAUSE button to start the cycle.
4. After the cycle has ended, secure the door slightly ajar with the door magnet. This will promote air circulation and allow the interior of the machine to dry. To use this feature, close the door just until it contacts the door magnet.

NOTE: Do NOT use this cycle with clothes, and do NOT add detergent or fabric softener.

AUTO SOAK

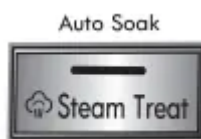

- Use the AUTO SOAK option to presoak garments to help remove difficult spots or stains on fabric. This option provides a 30-minute presoak prior to the start of the selected cycle. At the end of the presoak time, the selected cycle will use the same water.
- To use the AUTO SOAK feature, press and hold the STEAM TREAT button for three seconds.

ENERGY SAVER

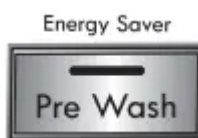

This option saves energy by using cooler water while increasing the wash and rinse times to maintain wash performance. This feature is only available with the NORMAL/ CASUAL and HEAVY DUTY cycles as listed below.

To use the Energy Saver option, press and hold the PRE WASH button for three seconds.

- NORMAL – Hot becomes Warm

- NORMAL – Warm becomes Cold
- HEAVY DUTY – Hot becomes Warm

CONTROL LOCK



- Use this option to disable the controls. The washer can only be locked during a cycle. This feature can prevent children from changing cycles or operating the machine. Once set, the controls remain locked and Control Lock must be turned OFF before the controls can be used again. Once the washer has shut off, the power button will allow the machine to be turned ON, but the controls will still be locked. When the controls are locked, “CL” will display alternately with the estimated time remaining.
- Press and hold the CHIME button for three seconds to activate or deactivate the controls

SMART GRID

Lower your laundry energy costs by avoiding peak usage periods, with information supplied by your local electric utility company.

NOTE: When Smart Grid is enabled, you may experience delays or extended cycle times during peak usage periods. To do laundry during peak usage periods without any delays, refer to the information below to cancel the Smart Grid function.

You must download the Kenmore Smart app to your mobile device, connect your Kenmore Smart appliance to the internet, and register the appliance to your account in order to use the Smart Grid function.

Connecting the Washer to the Internet

Refer to the Quick Start Guide that came with your smart appliance for detailed instructions on creating a Kenmore account and setting up the appliance for connected operation from your smart phone. For additional assistance, visit <http://www.kenmore.com/smart>.

Using Smart Grid

1. Smart Grid is initially enabled. Press the SMART GRID button once to disable the function. Once Smart Grid is set, the settings will be maintained even when the appliance is turned off.
2. Press the SMART GRID button before the cycle starts, to cancel the function completely. The Smart Grid LED will turn off.

3. Press the SMART GRID button during the cycle, to cancel the function for that cycle only. The Grid Mode LED will turn off and Smart Grid will be canceled for the cycle in process. Smart Grid will resume for the next cycle.

REMOTE START



Use a smart phone to control your appliance remotely.

NOTE: For better performance and to protect your clothes, this function can only be used with certain cycles and options. You must first close the door and connect to the internet to use this function. The SMART icon LED should be illuminated.

Using Remote Start

1. Select a cycle and options.
2. Press REMOTE START. The Remote Start LED will turn on.
3. Start the washer from the application on your smart phone. (For more information, see the booklet shipped with your washer.) If you do not start the washer remotely, the washer will wait to start the cycle until the START button is pressed.

MY CYCLE

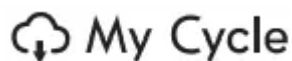

Use the My Cycle feature in the Kenmore Smart app to select and download an additional cycle to your washing machine. The default MY CYCLE on the washer is SMALL LOAD.

CARE AND CLEANING

WARNING: To reduce the risk of fire, electric shock, or injury to persons, read this entire Use & Care Guide, including the Important Safety Instructions, before operating this washer.

- Unplug the washer before cleaning to avoid the risk of electric shock. Failure to follow this warning can cause serious injury, fire, electric shock, or death.
- Never use harsh chemicals, abrasive cleaners, or solvents to clean the washer. They will damage the finish.

REGULAR CLEANING

Cleaning the Exterior

- Proper care of your washer can extend its life. The outside of the machine can be cleaned with warm water and a mild, nonabrasive household detergent. Immediately wipe off any spills with a soft, damp cloth.

IMPORTANT: Do not use solvents, cleaning alcohols, or similar products. Never use steel wool or abrasive cleaners because they can damage the surface.

Care and Cleaning of the Interior

- Use a towel or soft cloth to wipe around the washer door opening, door seal, and door glass. These areas should be kept clean to ensure a watertight seal. Be sure to wipe under the inside rubber seal to remove any moisture or soil. Always remove items from the washer as soon as the cycle is complete. Leaving damp items in the washer can cause wrinkling, color transfer, and odor. Run the CLEAN WASHER cycle once a month, or more often if needed, to remove detergent buildup and other residue.

Clean Washer

1. Remove any clothing in the drum.
2. Open the dispenser drawer.
3. Add liquid chlorine bleach or another drum cleaner designed specifically for cleaning front load washers.
 - If using liquid chlorine bleach Add liquid chlorine bleach to the bleach compartment of the drawer. (NOTE : Do not exceed the maximum fill line and do not pour undiluted liquid bleach directly into the wash drum.)
 - If using powdered cleaner Remove the liquid detergent cup and add powdered cleaner to the main wash compartment of the dispenser drawer.
 - If using tablet cleaner Add tablet cleaner directly to the wash drum.
NOTE: Do not add tablet cleaner to the dispenser drawer. Do not add any laundry detergent or fabric softener to the drawer when using CLEAN WASHER.
4. Turn ON the washer and press and hold the ACCELA WASH button for three seconds, and the LED will blink. Selecting any other cycle after CLEAN WASHER has been selected will cause the CLEAN WASHER cycle to be cancelled.
5. After the cycle ends, open the door and allow the drum interior to dry completely.

NOTE: Run the CLEAN WASHER cycle once a month. If a mildewy or musty smell is present, run the CLEAN WASHER cycle once a week for three consecutive weeks.

Door Seal and Glass Cleaning

Due to the location and nature of the door seal, some detergent and soil residue may build up on the door glass and seal. Periodic cleaning with a bleach solution can help remove buildup and stains, and can help sanitize the seal to prevent odors.

NOTE: Wear rubber gloves and eye protection while performing the following procedure:

1. Dilute $\frac{3}{4}$ cup (177 ml) liquid chlorine bleach in 1 gallon (3.8 L) of warm/hot water.
2. Use this solution to wipe down all surfaces of the gasket and door glass to remove any deposits. Be sure to fold back the lip of the gasket to get under the inner edge where residue can build up.

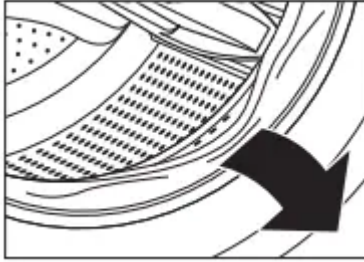

3. Dry the gasket and glass with a dry cloth.
4. To allow the gasket to dry completely, secure the door slightly ajar with the door magnet. This will promote air circulation and allow the interior of the machine to dry. To use this feature, close the door just until it contacts the door magnet.

NOTE:

- Follow the manufacturer's instructions for proper use of bleach.
- To avoid damaging the gasket, NEVER use undiluted bleach to clean the gasket.

Removing Mineral Buildup

- If you live in an area with hard water, mineral scale can form on internal components of the washer. Use of a water softener is recommended in areas with hard water.
- Use a descaler, such as Washer Magic®, to remove visible mineral buildup. After descaling, always run the CLEAN WASHER cycle before washing clothing. Do NOT use steel wool or abrasive cleaners.

Storing the Washer

If the washer will not be used for an extended period of time and is in an area that could be exposed to freezing temperatures, perform the following steps to protect the washer from damage.

1. Turn OFF the water supply.
2. Disconnect hoses from water supply and drain water from hoses.
3. Plug the power cord into a properly grounded electrical outlet.
4. Add 1 gallon of nontoxic recreational vehicle (RV) antifreeze to the empty wash drum and close the door.

5. Press the POWER button, then press the SPIN SPEED button without selecting a cycle. Press the START/ PAUSE button to activate the drain pump. This will expel some of the antifreeze, leaving enough to protect the washer from damage.
6. Unplug the power cord, dry the drum interior with a soft cloth, and close the door.
7. Refer to the instructions below to clean and dry the dispenser drawer.
8. Store the washer in an upright position.
9. To remove the antifreeze from the washer after storage, run the EXPRESS WASH cycle. Do not add laundry to this cycle.

Cleaning the Dispenser

The dispenser should be cleaned periodically to remove buildup of detergent and other laundry products that can cause the dispenser not to dispense the laundry product properly.

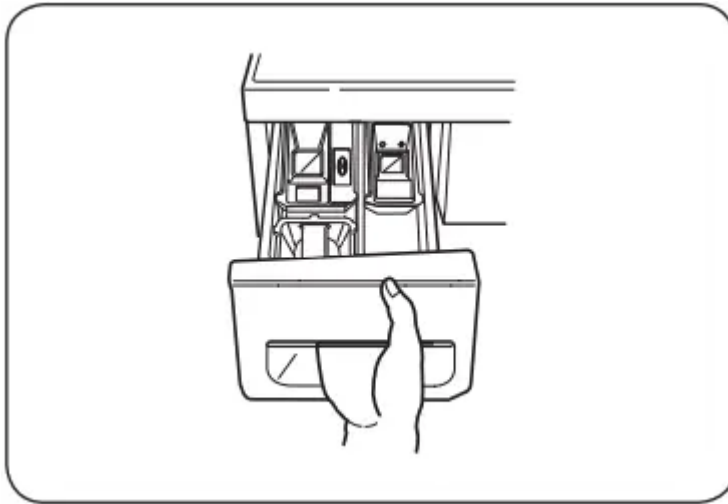

1. Pull the dispenser drawer out until it stops. REGULAR CLEANING (continued) CARE AND CLEANING

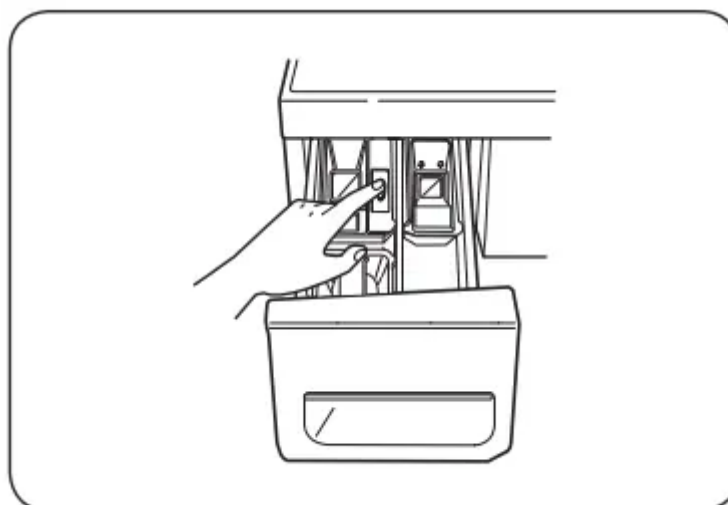

2. Press down the lock tab located between the bleach and softener compartments and slide the drawer out.

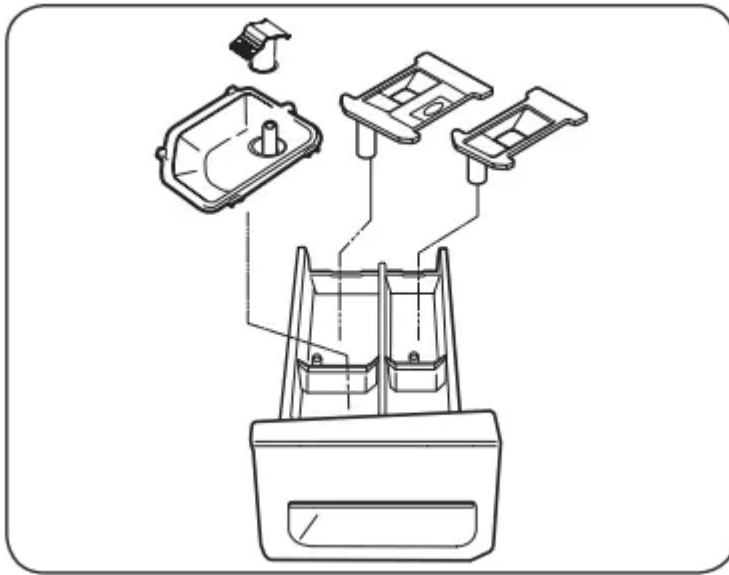

3. Remove the liquid detergent box, softener and bleach inserts from their compartments.

4. Clean the dispenser compartments and inserts with warm water.

WARNING: Certain internal parts are intentionally not grounded and may present a risk of electric shock only during servicing. Service personnel - Do not contact the following parts while the appliance is energized: pump, valve, motor, control board.

MAINTENANCE

Cleaning the Water Inlet Filters:

If the washer does not fill properly, an error message will show on the display. The inlet valve filter screens could be plugged by hard water scale, sediment in the water supply, or other debris.

NOTE: The inlet screens protect the delicate parts of the inlet valve from being damaged by particles that could enter the valves with the water supply. Operating the washer with these filters removed could cause a valve to fail to open, resulting in flooding and/or property damage.

IMPORTANT: ONLY use new, high-quality inlet hoses when installing this laundry product. Aftermarket hoses are not guaranteed to fit or function correctly. Other hoses may not tighten correctly and could cause leaks. Subsequent damage to product or property will not be covered under the terms of the product warranty.

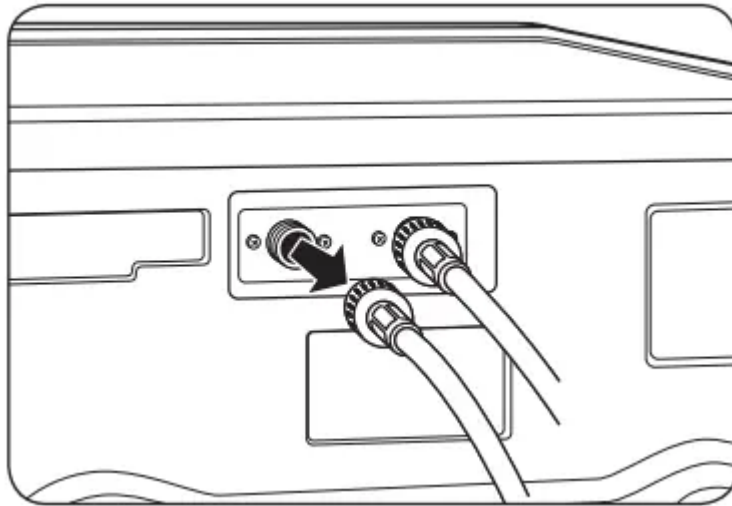

1. Turn OFF both water faucets completely. Unscrew the hot and cold water lines from the back of the washer.

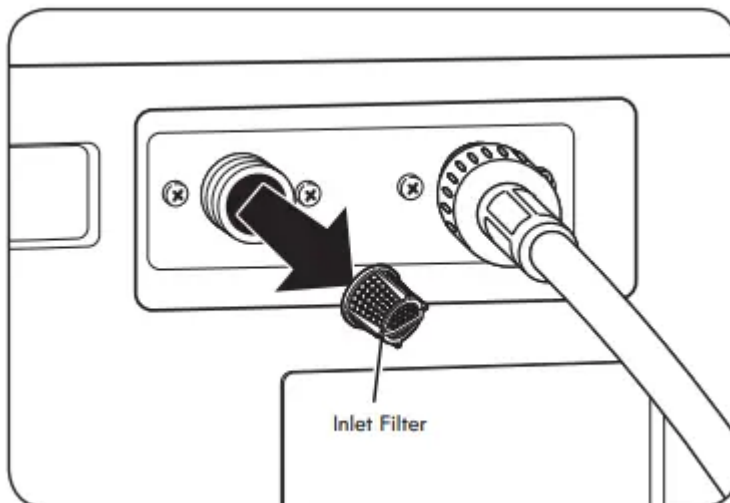

2. Carefully remove the filters from the water valves and soak them in white vinegar or a lime scale remover, following the manufacturer's instructions. Be careful not to damage the filters while cleaning.

3. Rinse thoroughly before reinstalling. Press the filters back into place.

4. Before reattaching the hoses, flush the hoses and water lines by running several gallons of water through the hoses and into a bucket or drain.

Cleaning the Drain Pump Filter

The washer is equipped with a filter that helps prevent excess lint and foreign objects like buttons, keys, and coins from causing damage to the pump. If the washer fails to drain properly, unplug the washer and allow the water to cool, if necessary, before proceeding.

1. Open the drain pump filter access panel.

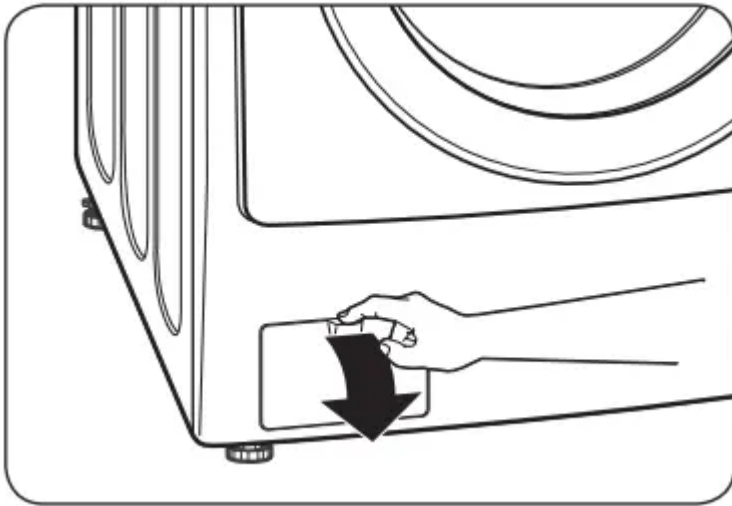

2. Unclip the drain hose and pull it out. Place the end of the drain hose into a shallow pan or a floor drain. Make sure not to pull the hose out too far, or it may not drain properly

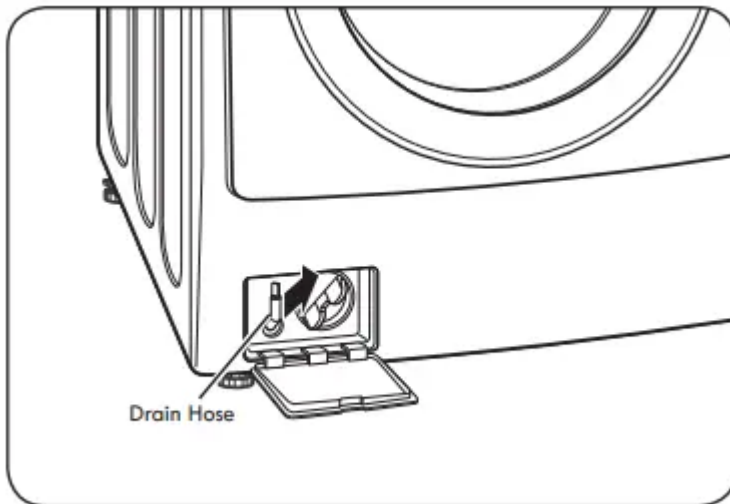

3. Remove the plug from the drain hose, and allow the water to drain completely.

NOTE: If there is a large amount of water in the drum, you may have to empty your container several times.

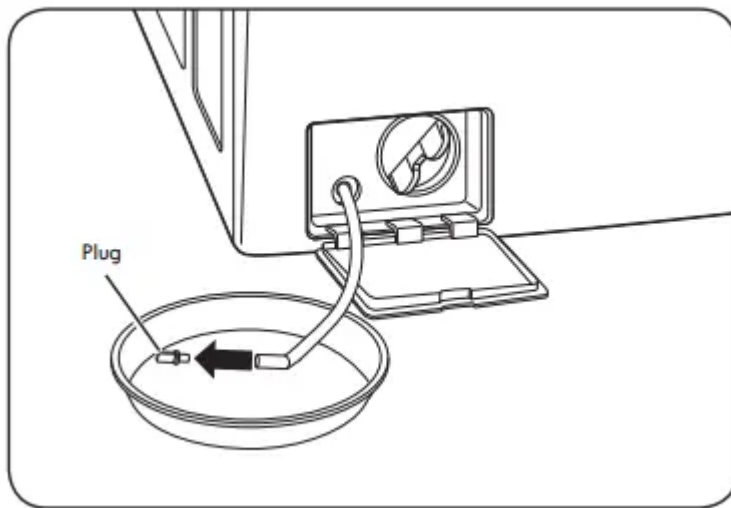

4. Twist the pump filter counterclockwise to remove. Remove any lint and foreign objects from the pump filter. Insert pump filter back into opening and twist clockwise to secure. Be sure to close the drain pump filter access panel.

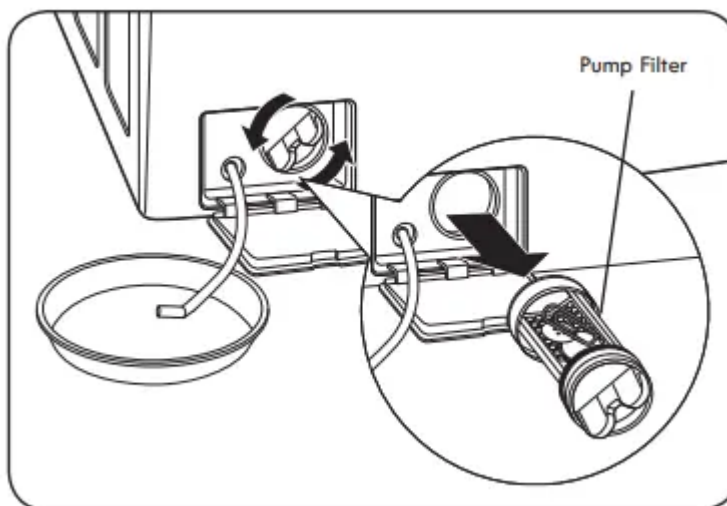

TROUBLESHOOTING GUIDE

NORMAL SOUNDS YOU MAY HEAR

The following sounds may be heard while the washer is operating. They are normal.

- Clicking: Door locking mechanism clicks when the door locks and unlocks.
- Humming or gurgling: Drain pump is pumping water from the washer at times during a cycle.
- Spraying or hissing: Water spraying or circulating during the cycle.
- Splashing: Clothes tumbling in the drum during the wash and rinse cycles.

BEFORE CALLING FOR SERVICE

If your washer does not function properly or does not function at all, check the following before you call for service.

Problem	Possible Cause	Solutions
Rattling and clanking noise	Foreign objects, such as keys, coins, or safety pins, may be in drum or pump.	Stop washer, check drum and drain filter for objects. If noise continues after washer is restarted, call for service.
Thumping sound	Heavy wash loads may produce a thumping sound. Washer load may be out of balance. Washing shoes or tightly tangled clothes.	This is normal. If sound continues, washer is probably out of balance. Stop and redistribute load. Pause the cycle and redistribute the load. Make sure door unlocks.
Vibrating noise	Shipping bolts and/or packaging materials were not removed. Wash load may be unevenly distributed in the drum. Not all leveling feet are resting firmly and evenly on the floor. Floor not rigid enough.	See the UNPACKING AND REMOVING section in the installation requirements. See the BOLTS section in the installation requirements. Pause the cycle and redistribute the load. Make sure door unlocks. See Leveling the Washer in the Installation Instructions. Make sure that the floor is solid and does not flex. See Flooring in the Installation Requirements.
Water leaking around washer	Inlet hose connection is loose at tap or washer. House drain pipes are clogged. Drain hose has come out of drain. Drain hose is not inserted far enough. Door glass is dirty.	Check hoses. Check and tighten hose connections. Unclog drain pipe. Contact a plumber if needed. Tie drain hose to inlet hose or standpipe to prevent it from coming out during drain. It should be inserted about 8-12 inches (20.3-30.5 cm) into the drain. Inspect door glass periodically to make sure there is no buildup of residue or other foreign matter. Follow the cleaning instructions.
Excessive sudsing	Too much detergent or incorrect detergent.	 Only use detergent with the High Efficiency (HE) logo. See Detergent Use in the Installation section.

<p>Staining</p>	<p>Bleach or softener dispensed too soon.</p> <p>Bleach or softener was added directly to the wash load in the drum.</p> <p>Washer was not unloaded promptly.</p> <p>Clothes were not properly sorted.</p>	<p>Dispenser compartment is overfilled causing bleach or softener to dispense immediately.</p> <p>Dispenser drawer closed too quickly causing bleach or softener to dispense immediately.</p> <p>Laundry chemicals must be loaded into the dispenser.</p> <p>Always remove items from the washer as soon as possible after the cycle is complete.</p> <p>Always wash dark colors separately from light colors and whites to prevent discoloration.</p> <p>Never wash heavily soiled items with lightly soiled items.</p>
<p>Washer will not turn ON</p>	<p>Power cord is not properly plugged in.</p> <p>House fuse is blown, circuit breaker has tripped, or power outage has occurred.</p> <p>House fuse is blown, circuit breaker has tripped, due to multiple appliances on one outlet.</p>	<p>Make sure that the plug is plugged securely into a grounded, 3-prong, 120-VAC, 60-Hz outlet.</p> <p>Reset circuit breaker or replace fuse. Do not exceed the fuse capacity. If the problem is a circuit breaker, it should be corrected by a qualified electrician.</p> <p>Reset circuit breaker or replace fuse. If no other appliance is connected to the outlet, call an electrician to have an additional circuit installed.</p>
<p>Door will not unlock when cycle is stopped or paused</p>	<p>Interior temperature of washer is too high.</p> <p>Water level in washer is too high.</p>	<p>The washer door has a safety feature to prevent personal injury. For example, if the washer is still hot during the hot wash stage of a sanitize cycle, the interior temperature of the drum will be very high and the door will not unlock. This is normal. Allow the washer to cool until the DOOR LOCK indicator turns OFF on the display.</p> <p>To drain the water, press POWER, then SPIN SPEED button without selecting a cycle.</p>
<p>Wash cycle time is longer than usual</p>	<p>The washer automatically adjusts the wash time for the amount of laundry, water pressure, water heating time and other operating conditions.</p>	<p>This is normal. The washer adjusts cycle time automatically to provide optimal results for the selected cycle. The time remaining shown on the display is only an estimate. Actual time may vary.</p>



<p>Musty or mildewy odor in washer</p>	<p>Incorrect or too much detergent has been used.</p> <p>Inside of drum was not cleaned properly.</p>	<p>Use only High-Efficiency (HE) detergent in accordance with the manufacturer's instructions.</p> <p>Run the CLEAN WASHER cycle regularly. Wipe around and under the door seal frequently. Refer to the Care and Cleaning of the Interior.</p> <p>Clean around door seal/glass to prevent mildew.</p>
<p>Wrinkling</p>	<p>Washer not unloaded promptly.</p> <p>Washer overloaded.</p> <p>Hot and cold water inlet hoses are reversed.</p>	<p>Always remove items from the washer as soon as the cycle is complete.</p> <p>When washing large loads, do not overload. The washer can be fully loaded, but the items should not be tightly packed and the door should be closed.</p> <p>Hot water rinse can set wrinkles in garments. Reverse the inlet hose connections.</p>
<p>Strange odors coming from washer</p>	<p>Dryer heating.</p> <p>Newly installed washer.</p> <p>Build-up of residue on washer, foreign object in door gasket, clogged drain pump filter, clogged or kinked drain hose.</p>	<p>As the dryer heats, it may initially cause a musty smell. This is normal and does not affect performance.</p> <p>Smell comes from the rubber attached to the door. It will eventually dissipate after first few wash cycles.</p> <p>Periodically clean the gasket. Mold and mildew or other substances inside the gasket may produce musty smells.</p> <p>Clean the drain pump filter regularly. Foreign objects or substances on the drain pump filter may produce mildew or musty smells.</p> <p>If the drain hose is not installed properly, a musty smell may be emitted because of a backflow of drain water into the tub. Make sure that the drain hose is not clogged.</p>

Your washing machine is equipped with an automatic error-monitoring system to detect and diagnose problems at an early stage.

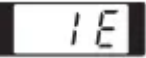
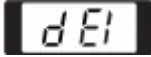
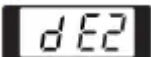
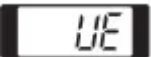

Problem	Possible Cause	Solutions
<p>Water in the washer drains slowly or not at all, or the display shows: </p>	<p>Drain hose is kinked, pinched, or clogged.</p> <p>The drain pump filter is clogged.</p> <p>Drain discharge is more than 96 inches (244 cm) above bottom of washer.</p>	<p>Make sure the drain hose is free of clogs, and is not pinched behind or under the washer. Clean the drain pump filter. See Maintenance and Cleaning section.</p> <p>Adjust or repair drain. Maximum drain height is 96 inches (244 cm).</p>
<p>Washer fills with water slowly or not at all, or the display shows: </p>	<p>Water supply faucets are not open fully. Water line hoses are kinked, pinched, or crushed.</p> <p>Water inlet filters are clogged.</p> <p>Water supply pressure to faucet or house is too low.</p> <p>Water supply connected with leak-limiting hoses.</p>	<p>Make sure that the water faucets are fully open.</p> <p>Make sure the hoses are not kinked or pinched. Be careful when moving the washer during or after maintenance.</p> <p>Clean the inlet filters. See Maintenance and Cleaning section.</p> <p>Check another faucet in the house to make sure household water pressure is adequate and not restricted.</p> <p>Hoses designed to limit leaks can trip false leaks and prevent the washer from filling. The use of leak-limiting hoses is not recommended.</p>
<p>Cycle won't start, or the display shows:  or </p>	<p>The door is not closed properly.</p>	<p>Make sure that the door is closed properly. Press the START/PAUSE button. After starting a cycle, it may take a few moments before the drum starts to turn or spin. The washer will not operate if the door is locked.</p> <p>If the door is closed and locked and the error message is displayed, call for service.</p>
<p>The display shows: </p>	<p>Load is too small.</p> <p>Load is out of balance.</p>	<p>Add 1 or 2 similar items to help balance the load.</p> <p>The washer has an imbalance detection and correction system. If individual heavy articles are overloaded (bath mat, bath robe, etc.) and the imbalance is too great, the washer will make several attempts to restart the spin cycle.</p>

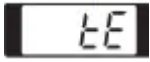
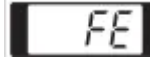
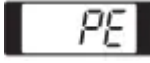
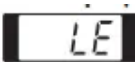
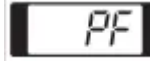
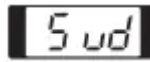
		imbalance is still detected, the washer will display the error code.
<p>The display shows:</p> 	Control error.	Unplug the washer and wait 60 seconds. Plug the washer back in and try again. If the error reappears, call for service.
<p>The display shows:</p> 	Water level is too high due to a faulty water valve.	Close the water faucets, unplug the washer, and call for service.
<p>The display shows:</p> 	The water level sensor is not working correctly.	Close the water faucets, unplug the washer, and call for service.
<p>The display shows:</p> 	A motor error has occurred.	Allow the washer to stand for 30 minutes. Plug the washer back in and restart the cycle. If the LE error code persists, call for service.
<p>The display shows:</p> 	A power failure has occurred.	If the power to the washer has been interrupted during a cycle, the PF error code will display when the washer is turned ON. This will allow you to restart the cycle. In fact, the previous cycle may not have completed. Select any cycle to clear the error and use the washer.
<p>The display shows:</p> 	If the washing machine detects too many suds, it displays this error code and adds a Suds Reducing cycle. This adds about two hours to the cycle time. If too many suds are detected during spinning, the washing machine stops to help prevent leaking.	Do not add more than the manufacturer's recommended amount of detergent. To remove suds, turn the washer off and wait 30 minutes. Then restart the Rinse & Spin cycle.

Warning

This content is compiled from multiple sources and is provided for reference purposes only. It may not be complete or fully applicable to all situations. If you are unable to resolve your issue, please contact the product manufacturer or an authorized service provider for official support.