

Environmental protection

Packaging/old appliance



Dispose of packaging in an environmentally-responsible manner.

This appliance is labelled in accordance with European Directive 2012/19/EU concerning used electrical and electronic appliances (waste electrical and electronic equipment - WEEE).

The guideline determines the framework for the return and recycling of used appliances as applicable throughout the EU.

Energy-saving tips

- Spin the laundry before drying. The drier the laundry, the shorter the drying time will be, thus consuming less energy.

- Load the dryer with the maximum load.

Note: Do not exceed the maximum load for the programs, as this prolongs the drying time and increases energy consumption.

- Ventilate the room and keep the air inlet on the dryer free to ensure air exchange.

- Clean the fluff filter after each drying cycle. If the fluff filter is dirty, the drying time is prolonged and energy consumption is increased.

- **Energy saving mode:** If the dryer is not operated for a prolonged period, it automatically switches off before the program starts and when the program has ended to save energy. The display panel and indicator lamps go off after a few minutes and the Start button flashes. To activate the lighting, press any button, open or close the dryer door or turn the program selector.

Installation and connection

Scope of delivery

- Dryer
- Installation and operating instructions
- Basket for woollens *
- Condensation drain*

Installing and connecting the dryer

Warning Risk of death!

There is a risk of electric shock as the dryer is operated with electricity.

- Check the dryer for visible damage. You must not operate the dryer if it is damaged.
- Before connecting the dryer to the power supply, ensure that the electric voltage specified on the rating plate matches the voltage of your socket.
- Only use residual current circuit breakers with the following symbol: 
- Ensure that the mains cable is not kinked or trapped and that it does not come into contact with heat sources or sharp edges.

Warning

Children could lock themselves in the dryer, putting their lives at risk!

Do not set up the dryer behind a door or sliding door as this may obstruct the dryer door or prevent it from opening.

Caution! Risk of injury

- As the dryer is heavy, you could injure yourself by trying to lift it. Do not lift the dryer on your own.
- You could cut your hands on the sharp edges of the dryer. Do not hold the dryer by the sharp edges.
- Protruding parts on the dryer may break off when it is lifted or pushed. Do not move the dryer by holding on to protruding parts.

Caution!

Risk of material damage to the dryer or fabrics

- Check the dryer for damage caused during transportation. Never operate a dryer if it is damaged.
- Any residual water in the dryer may freeze and damage the dryer. Do not install the dryer in rooms that are at risk of frost.

During installation ensure that:

- The dryer is placed on a clean, level and firm surface,
- The mains plug can be accessed at all times,
- The air inlet on the dryer is kept clear and there is sufficient ventilation,
- The area around the dryer is kept clean and
- The dryer is levelled using the threaded feet.

Note: Check the alignment of the appliance with a spirit level and correct if necessary. Change the height by turning the appliance feet. All appliance feet must stand firmly on the ground.

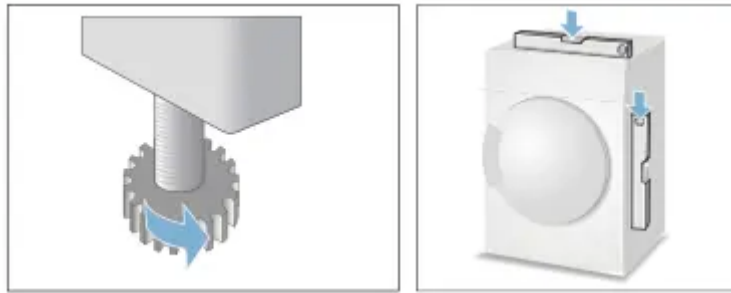

Incorrect alignment may cause high noise levels, vibrations and improper movement of the drum.

Note: If in doubt, have the appliance connected by a specialist.

Optional accessories

Order optional accessories * from the after-sales service:

■ Washer-dryer stack connection set:

To save space, the dryer can be placed on top of a suitable washing machine of the same width and depth.

The dryer must be fastened to the washing machine using this connection set.

Order number with pull-out worktop: WTZ11400; Order number without pull-out worktop: WTZ20410.

* Depending on the model

■ Platform:

For easier loading and unloading, raise your dryer with a platform. Transport laundry with the clothes basket integrated into the platform drawer.

Order number: WMZ20500.

■ Basket for woollens:

Dry individual woollen items, sports shoes and soft toys in the basket for woollens.

Order number: WMZ20600.

Transport and frost protection

To empty the condensate container:

1. Use the programme selector to select any programme.
2. Press the Start button.
3. Wait for 5 minutes.

Note: The condensation is drained.

4. Empty the condensate container again.
5. Switch off the dryer.

Caution!

Any residual water may leak out and cause material damage. Transport the dryer in an upright position.

Draining the condensation water

Condensation will form in the appliance as it dries the laundry.

You must ensure that the drain hose is connected when you operate the appliance.

If there is no drain hose connected to the appliance, the condensation water from the appliance will run into the condensation container. In this case, you will need to empty the condensation container each time the dryer finishes drying the laundry, and also if it becomes full before drying is complete.

Connect the drain hose as follows:

1. Remove the accessories from the dryer drum.

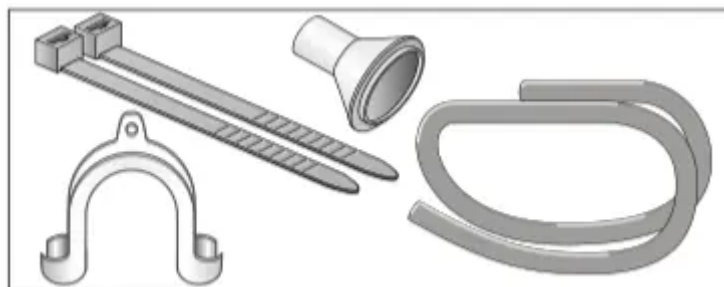

2. When the dryer is delivered from the factory, the hose for discharging the condensation into the condensation container is fastened to the connecting piece.
3. Detach the condensation hose from the socket.

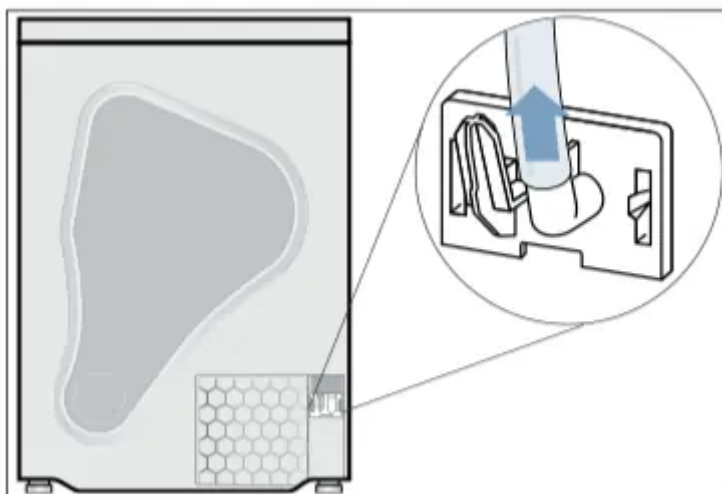

4. Place the condensation hose in the "parked" position.

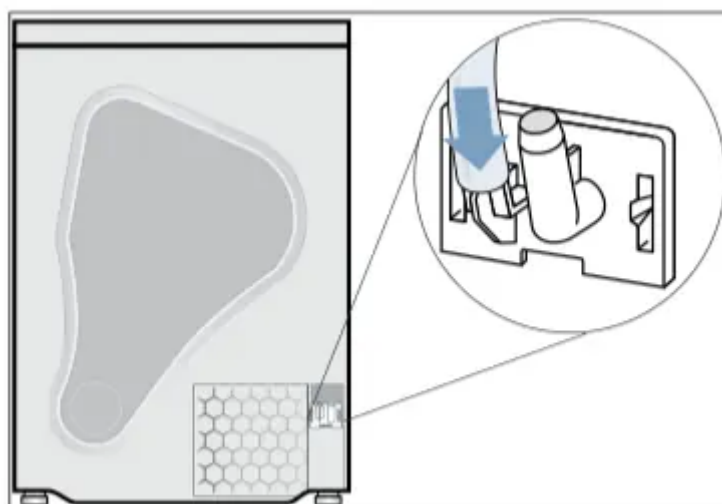

5. Take the drain hose from the accessories and secure it to the free connecting piece.

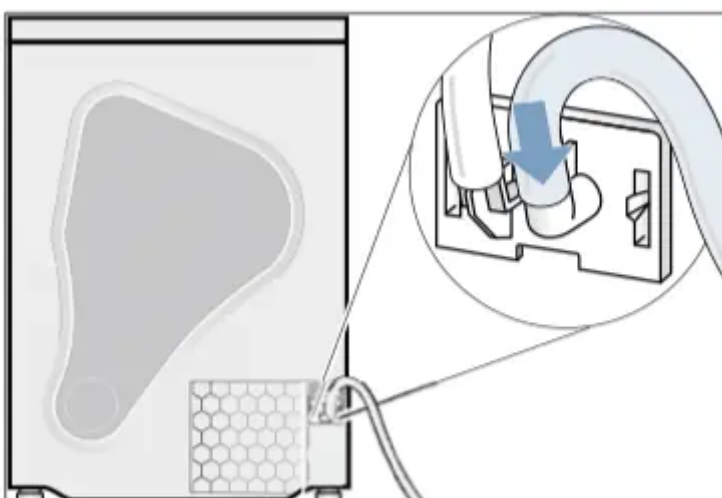

6. Fasten the other end of the drain hose with the remaining accessories, depending on the connection situation (A, B or C).

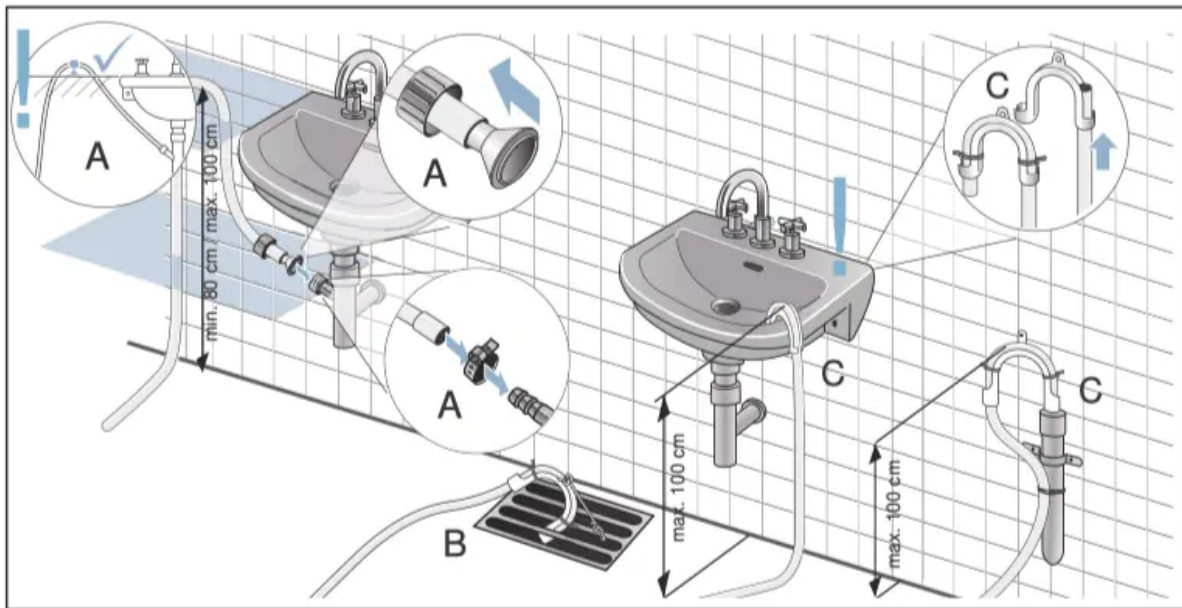

Caution!

Accumulated water can be drawn back into the dryer and may cause material damage.

Check that the water drains away from the wash basin quickly. The drain must not be sealed or blocked.

Caution!

Material damage due to leaks or draining water.

Secure the drain hose so that it cannot slip out. Do not kink the drain hose. Ensure that a height difference of max. 100 cm and min. 80 cm between the installation surface and the drain is maintained for drainage into a siphon.

The condensation water is now discharged via the drain hose into the waste-water system or into a washbasin.

Note:

If you want to drain the condensation water back into the condensation container, reverse these steps.

The main points in brief

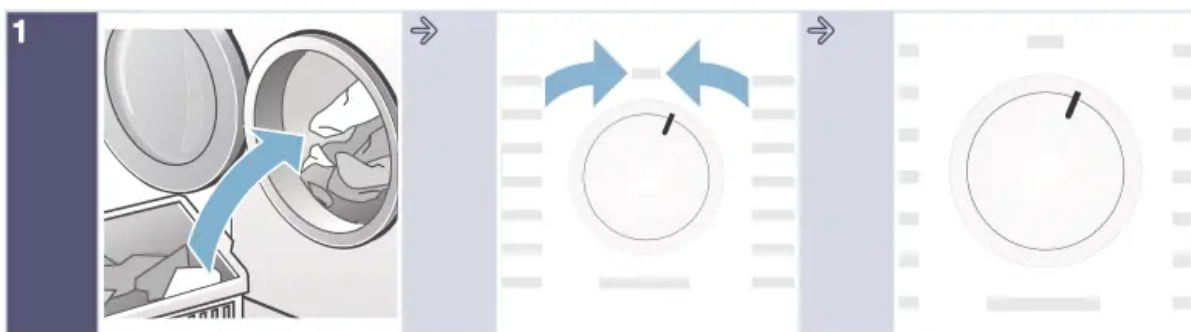

1. Load the laundry and close the door.
2. Switch on the dryer.
3. Select a programme and, if necessary, adjust the programme default settings.



1. Select the start button 
2. Dry.
3. Unload the laundry.

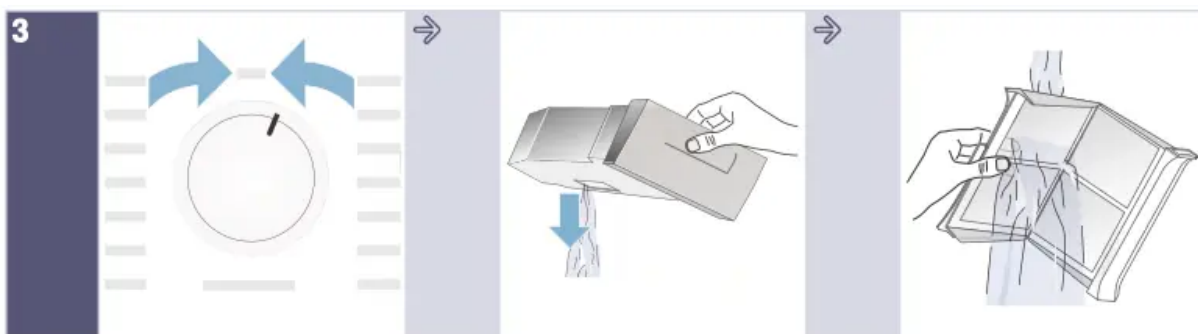

1. Switch off the dryer.
2. Empty the condensate container.
3. Clean the fluff filter.

Getting to know your appliance

Dryer

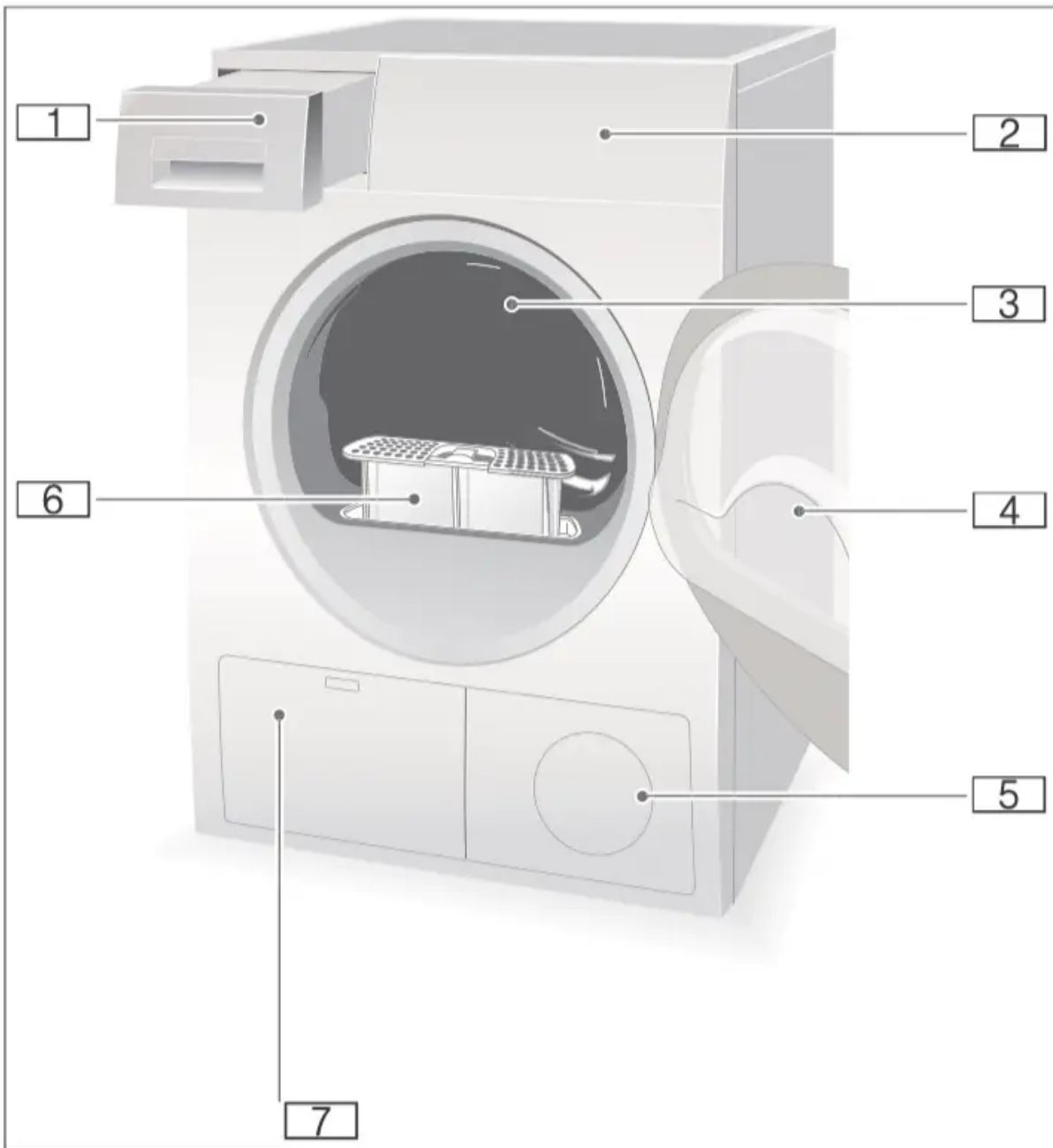

- 1** Condensate container
- 2** Control and display panel
- 3** Drum interior light (depending on the model)
- 4** Dryer door
- 5** Air inlet

6 Fluff filter

7 Heat exchanger

Control panel

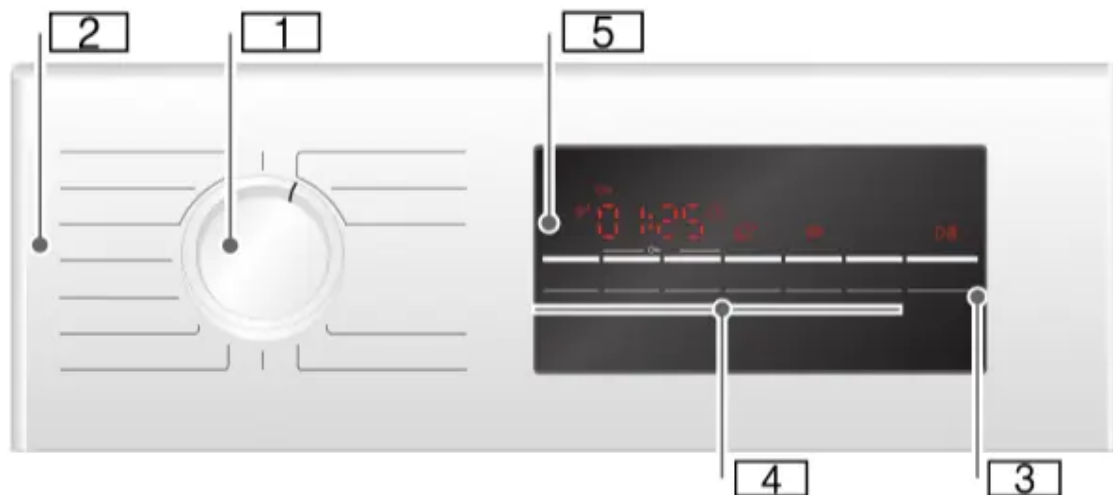

1 Use the programme selector to switch the dryer on and off and to select the programme.

2 Programmes → Page 22.

3 Start button for starting or interrupting the programme → Page 24.

4 Buttons → Page 24.

5 Display panel with buttons → Page 20.

Display panel

Buttons in the display panel

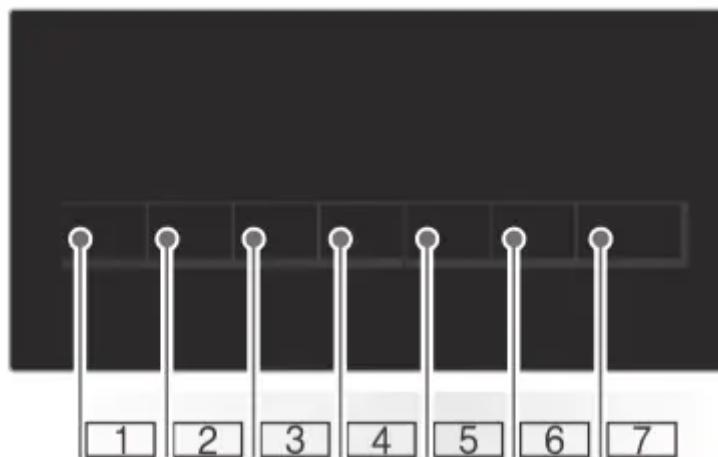







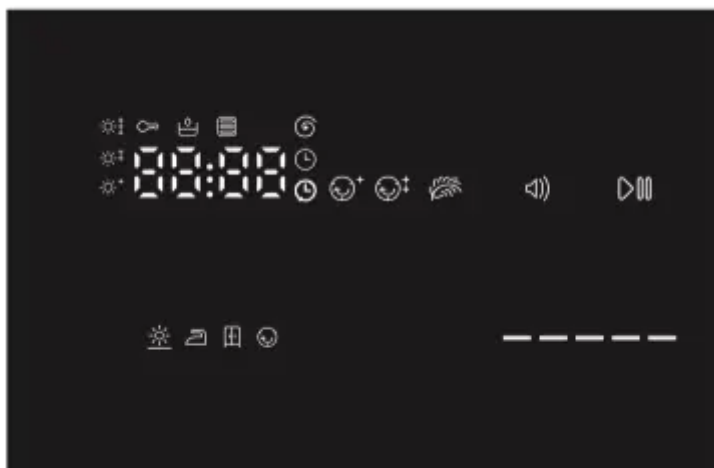







- 1 Select the degree of dryness.
- 2 Select the drying time.
- 3 Select the Ready in time.
- 4 Select Anti-Crease.
- 5 Select Low-Heat Drying.
- 6 Switch the signal on or off.
- 7 Select Start/Pause.

For a detailed description of all buttons, see → Page 24 onwards.

Display panel



	"Anti-Crease" selected.
	Fine adjustment of the dryness level.
	Time programme selected.
	"Ready in" time selected.
	Childproof lock selected.
	Spin speed selected.
	Low-Heat Drying selected.
	Audible signal active.
	Start or Pause selected.
3 h	Programme delay in hours when "Ready in" time is selected.
1:27	Expected programme duration in hours and minutes.
   	End - P - Programme progress: Dry; Iron Dry; Cupboard Dry; Anti-Crease; End and Pause.
	Empties the condensate container; → <i>Page 28</i> .
	Cleans the fluff filters; → <i>Page 27</i> .

Laundry

Preparing the laundry

Warning

Risk of explosion/fire!

Remove any cigarette lighters and matches from pockets.

Caution!

The dryer drum and fabrics could be damaged.

Remove all objects from pockets and observe the following information:

- Tie cloth belts, apron strings, etc. together or use a laundry bag.
- Close zips, hooks and eyelets and buttons. Button up large items of laundry, such as covers.
- Remove any metal objects, such as paper clips, from pockets.

- To ensure a consistent drying result, sort laundry by fabric type and drying programme.
- Always dry very small items of laundry, e.g. babies' socks, together with large items such as towels.
- Knitted fabrics such as T-shirts and jerseys often shrink the first time they are tumble-dried. Use a gentle programme.
- Do not overdry easy-care laundry. This increases creasing of the laundry.
- Use timed programmes for single garments.
- Some detergents and care products, e.g. starch or softeners, contain particles which may be deposited on the moisture sensor. This may impair the sensor function and in consequence the drying result.

Notes

- When washing laundry to be tumble-dried, use the correct amount of detergent and care products as specified in the manufacturer's instructions.
- Clean the moisture sensor regularly → Page 31.

Sorting washing according to:

- Suitable for tumble drying a
- Dry at normal temperature
- Dry at low temperature
- Do not tumble-dry

Note: Do not load laundry from the washing machine directly into the tumble dryer. Sort the spun laundry before placing it in the dryer drum.

If you dry thin, thick and multi-layer fabrics together, they will dry to differing degrees. To achieve an even drying result, you should therefore only dry together laundry of the same type of fabric and structure. If you feel that the laundry is still too damp, you can select a timed programme for subsequent drying → Page 22.

Caution!

Possibility of material damage to the dryer or laundry.













Do not tumble-dry the following fabrics:



- Laundry contaminated with oil.
- Unwashed fabrics.
- Non-breathable fabrics (e.g. rubbercoated).







- Easily damaged fabrics such as silk, synthetic curtains.

Programmes and buttons

Programmes

Programme and fabrics	Maximum load and programme settings/info
<p>Name of the programme</p> <p>Which fabrics is the programme suitable for?</p>	<p>The maximum load is based on the dry weight of the fabrics</p> <p>Possible programme settings</p>
<p>Cotton  Very Dry </p> <p>Hard-wearing, heat-resistant fabrics that are made of more than one layer of cotton or linen and do not dry readily.</p>	<p>8 kg</p>
<p>Cotton  Cupboard Dry </p> <p>Normal, hard-wearing and heat-resistant fabrics made of a single layer of cotton or linen.</p>	<p>8 kg</p>
<p>Cotton  Iron Dry </p> <p>Normal, hard-wearing and heat-resistant fabrics made of a single layer of cotton or linen that need to be damp after drying and are suitable for ironing or hanging up.</p>	<p>8 kg</p>
<p>Easy Care  Very Dry </p> <p>Synthetic or blended fabrics that are made of more than one layer and do not dry readily.</p>	<p>3.5 kg</p>
<p>Easy Care  Cupboard Dry </p> <p>Normal synthetic or blended fabrics made of a single layer.</p>	<p>3.5 kg</p>
<p>Easy Care  Iron Dry </p>	<p>3.5 kg</p>

<p>Normal synthetic or blended fabrics made of a single layer that need to be damp after drying and are suitable for ironing or hanging up.</p>	
<p>Sportswear </p> <p>Weatherproof and outdoor clothing with a membrane coating and water-repellent fabrics.</p>	<p>1.5 kg</p>
<p>Allergy Plus </p> <p>Hard-wearing towels made of cotton.</p>	<p>6 kg</p>
<p>Mix </p> <p>Mixed load consisting of cotton and synthetic fabrics.</p>	<p>3 kg</p>











<p>Timed program warm </p> <p>All types of fabric; time programme.</p> <p>Suitable for pre-dried or slightly damp laundry and for drying off multi-layered, thick laundry.</p> <p>Notes</p> <ul style="list-style-type: none"> ■ Only dry wool, sports shoes and soft toys with the basket for woollens → Page 14. ■ In the time programme, the laundry's residual moisture is not automatically detected. If the laundry is still too damp after the drying programme, repeat the programme and, if required, extend the programme length. 	<p>3 kg</p>
<p>Timed program cold </p> <p>All types of fabric. For freshening up or airing items of laundry that have not been worn for long.</p>	<p>3 kg</p>
<p>Shirts 15' </p> <p>For optimum drying results, dry a maximum of 5 shirts at one time. After drying, iron the laundry or hang it up and leave for a period of time: Residual moisture is then distributed evenly.</p>	<p>1 kg</p>
<p>SuperQuick 40' </p> <p>Synthetics and light cottons.</p>	<p>2 kg</p>
<p>Down Wear </p> <p>Fabrics, pillows, bedspreads or eiderdowns filled with down.</p> <p>Dry large items individually.</p>	<p>1.5 kg</p>
<p>Wool finish </p>	<p>3 kg</p>

Fabrics made from wool or a wool blend that are suitable for tumble drying.

--



Buttons

Buttons	Explanations and notes
<p>Note: Not all buttons and their functions can be selected in all programmes.</p>	
<p>Fine adjust </p>	<p>If the laundry is too damp after drying, you can finely adjust the dryness level e.g. Cupboard Dry. The dryness level can be increased with the degree of dryness in three stages, from  to .</p> <p>If you have adjusted the dryness level, the setting for all programmes with a selectable dryness level is retained even after the dryer is switched off.</p> <p>Note: The higher the degree of dryness, the longer the programme duration.</p>
<p>Drying Time </p>	<p>Adjust the programme length for the time programmes. Between 20 minutes and 3 hours, in 10-minute increments.</p>
<p>Finished in </p>	<p>The programme will end in 1-24 hrs. Set the "Ready in" time in increments of one hour to delay the start of the programme. The required number of hours after the programme ends is displayed in the display panel.</p>
<p>Easy-Iron </p>	<p>The drum moves the laundry at regular intervals for 60 or 120 minutes after drying, in any programme, to prevent creasing.</p>
<p>Low Heat </p>	<p>Reduced temperature for delicate fabrics, e.g. polyacrylic or elastane. Selecting the button will extend the drying time.</p>
<p>Buzzer </p>	<p>A signal sounds after the programme has ended.</p>
<p> 3 sec. (Childproof lock 3 sec.)</p>	<p>Press and hold the "Ready in" time button and the drying time button at the same time for 3 seconds to activate or deactivate the childproof lock.</p>
<p>Start/Pause </p>	<p>Starts or pauses the programme.</p>

Operating the appliance

Loading laundry and switching on the dryer

Note: The dryer must be correctly positioned and connected, → Page 13.

1. Place the laundry in the drum.
2. Turn the programme selector to any programme to switch the dryer on.
3. Close the dryer door.

Caution!

Possibility of material damage to the dryer or laundry.

Take care not to trap any laundry in the door.

Setting a programme

Note: If you have activated the childproof lock, you must deactivate it before you can set a programme, see → Page 24.

1. Select the required programme; detailed information on the programmes can be found from → Page 22 onwards.
2. Use the programme selector to set the required programme. The default programme settings for the selected programme appear in the display panel.

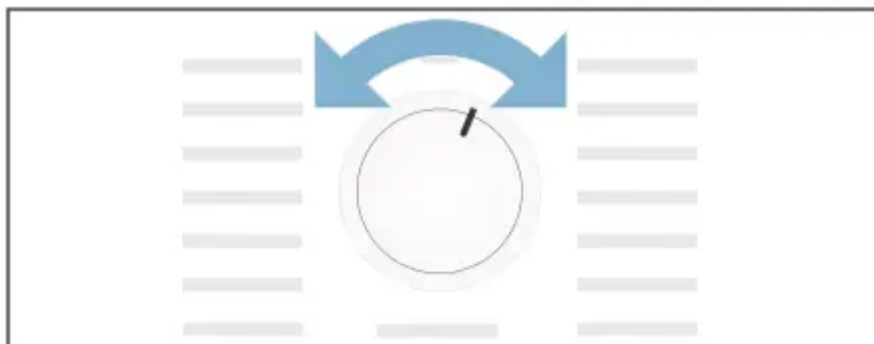

Note: Default programme settings are standard settings that are already defined when a programme is selected. After selecting a programme, you can see the default programme settings in the display panel.

3. If required, adjust the default programme settings. You can find detailed information on this from → Page 22 onwards.

Starting the programme

Press the Start button.

Note: If you want to lock the programme to prevent it from being adjusted inadvertently, you can select the childproof lock, see → Page 24.

Programme sequence

The programme status is indicated in the display field.

e.g. 1:27 Expected programme duration in hours and minutes.

Note: When a programme is selected, the expected drying time for the recommended load is displayed. During drying moisture sensors detect the remaining moisture in the load and adjust the programme length (except timed programmes). This is visible via the time remaining leaping forward.



Dry



Iron Dry



Cupboard Dry



AntiCrease



- P - Pause



End

Changing the programme or adding laundry

You can remove or add laundry and change or alter the programme at any time during drying.

1. To pause the programme, open the dryer door or press the Start button.
2. Add or remove laundry.
3. Select another programme or an additional function, if required.
4. Close the dryer door.
5. Press the Start button.

Note: The programme duration in the display panel is updated depending on the load and residual moisture in the laundry. The values displayed may change after the programme is changed or the load is adapted.

Cancelling the programme

The programme can be interrupted at any time; to pause, open the dryer door or press the Start button.

Caution!

Risk of fire. Laundry may catch fire.

If you cancel the programme, you must remove the laundry items and spread them out so that the heat can disperse.

Programme end

End appears in the display panel.

Removing laundry and switching off the dryer

1. Remove the laundry.
2. Turn the programme selector to the "off" position.

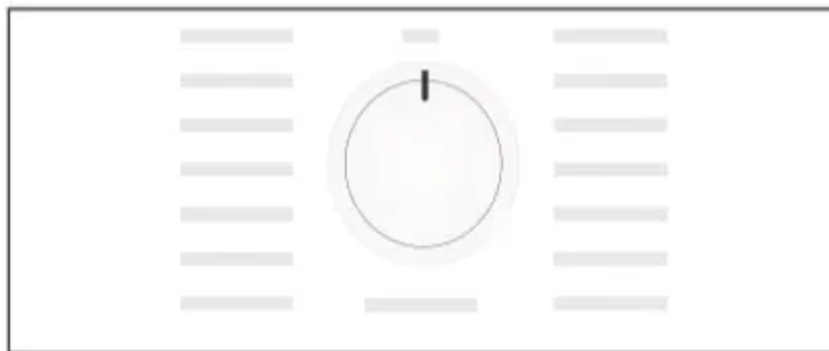

Clean the fluff filter

Note: During drying, fluff and hair from the laundry is trapped by the fluff filter. If the fluff filter is blocked or dirty, this reduces the flow of air, which prevents the dryer from achieving its maximum performance. Clean fluff filters also reduce energy consumption and the drying time.

Clean the fluff filter after each drying cycle:

1. Open the dryer door and remove all fluff from the door.
2. Remove the fluff filter.

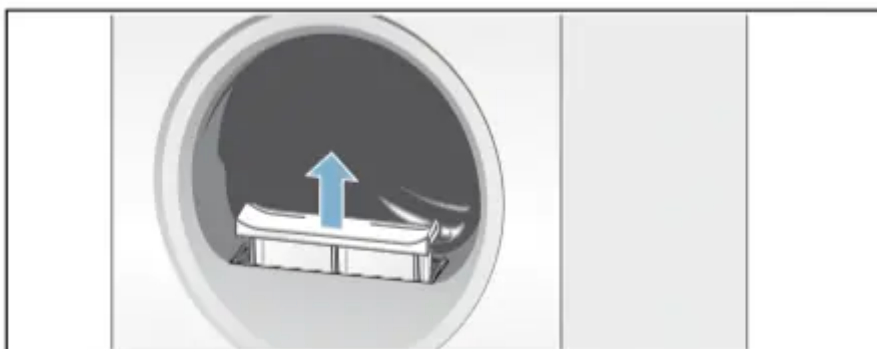

3. Remove the fluff from the fluff filter.

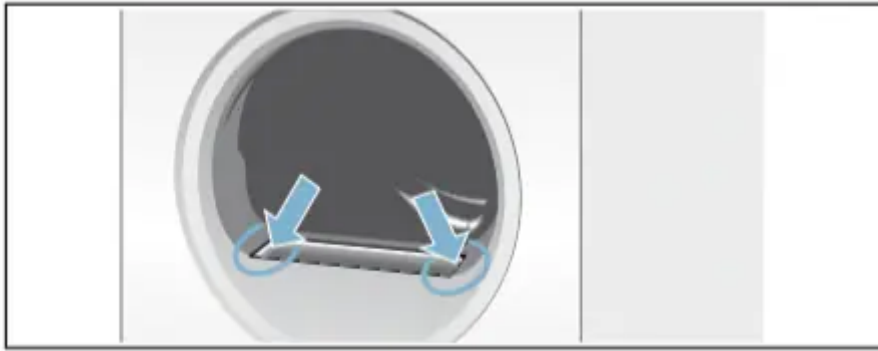

Note: Ensure that no fluff falls into the open shaft.

4. Open the fluff filter and remove all the fluff.
5. Rinse away the fluff under running water or clean the fluff filter in the dishwasher.

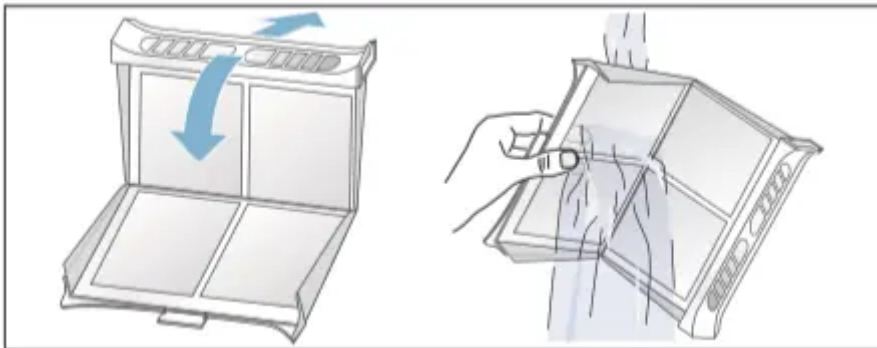

6. Dry the fluff filter, close it and reinsert the fluff filter.

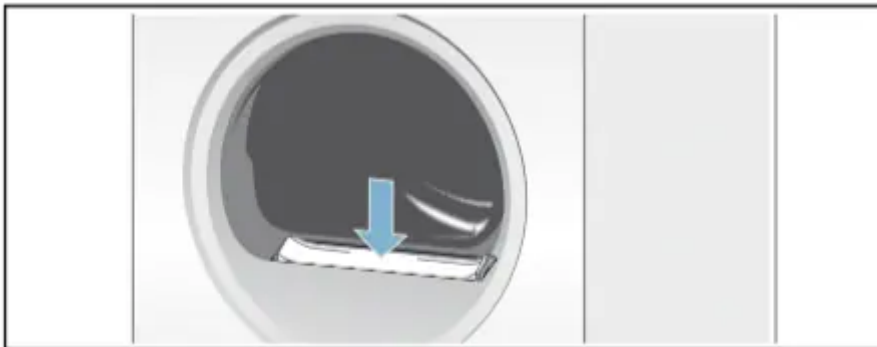

Caution!

The dryer may be damaged.

Do not operate the dryer without a fluff filter or if the fluff filter is defective.

Emptying the condensate container

By default, the condensation from the appliance runs into the condensation container.

Alternatively, you have the option of discharging the condensation water * supplied depending on the model. If you choose to discharge the condensation water into the waste-water system, you will



not need to empty the condensation container during the drying programme or after each time you use the dryer.

1. Pull out the condensate container horizontally.

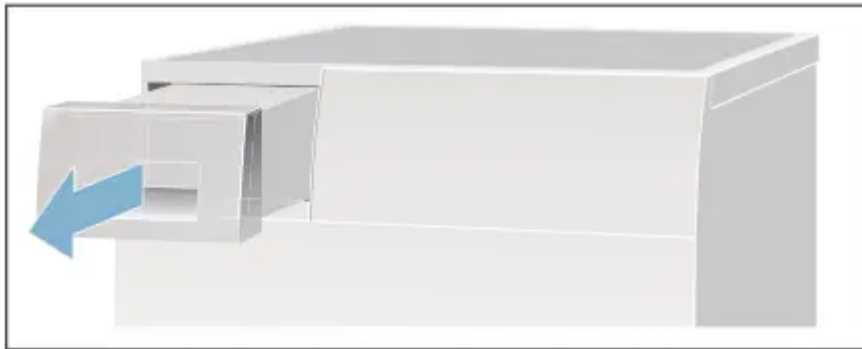

2. Pour out the condensation water.

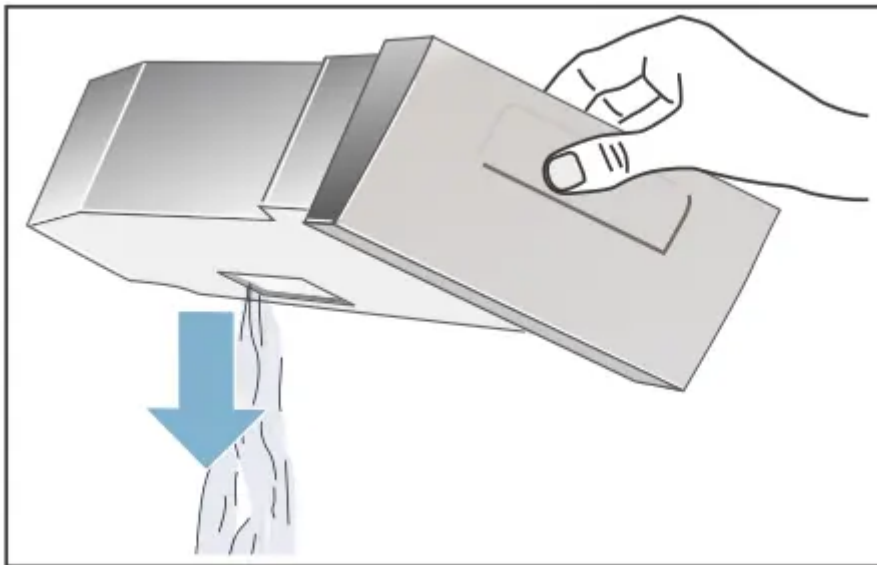

Caution!

Dirty condensation water may be harmful to your health and cause material damage.

Condensation water is not suitable for drinking and may be contaminated with fluff. Do not drink the condensation water or reuse it.

* into the waste-water system via a drain hose

3. Push in the condensate container until you feel it lock back into place in the dryer.





Signal setting

You can change the following settings:

- The spin speed that is used for spinning your laundry before it is dried,
- The volume of the audible signal at the end of the programme,
- The volume of the audible button signals.

You will need to activate the setting mode in order to change these settings.



Activating setting mode

1. Switch the dryer on.
2. Select the "Cottons" programme in position 1 and wait for five seconds. Setting mode is now activated.

The symbols go out in the display panel and the programme duration is displayed.

1. Press and hold the Start button and, at the same time, turn the programme selector clockwise to position 2.
2. The spin speed is shown in the display.
3. Press the "Ready in" time button or the drying time button to change the spin speed.
4. Turn the programme selector clockwise to position 3.
5. The volume of the audible signal at the end of the programme is shown in the display.



0 = off, 1 = quiet, 2 = medium, 3 = loud, 4 = very loud

6. Press the "Ready in" time button or the drying time button to change the volume.
7. Turn the programme selector clockwise to position 4.
8. The volume for the audible button signal is shown in the display.



0 = off, 1 = quiet, 2 = medium, 3 = loud, 4 = very loud

9. Press the "Ready in" time button or the drying time button to change the volume.

Exiting setting mode

Turn the programme selector to the "Off" position once you have set the required spin speed and the volume. The settings have now been saved.

Cleaning

Cleaning the dryer and the control panel

Warning Risk of death!

There is a risk of electric shock as the dryer is operated with electricity. Disconnect the dryer from the mains before cleaning.

Clean the dryer using only water and a soft, damp cloth.

Remove all detergent residue, spray residue or other residues immediately. Do not use cleaning agents or agents for pre-treating laundry (e.g. prewash sprays, stain removers). Do not use high-pressure cleaners or steam jet cleaners to clean your appliance.

Cleaning the heat exchanger

Notes

- Clean the heat exchanger several times a month if you use the dryer more than twice a week.

- If there is debris in the heat exchanger, this will increase the amount of time required for drying and will compromise the drying results.

1. Allow the dryer to cool down and place an absorbent cloth beneath the maintenance flap.

Note: Residual water may leak out.

2. Open the maintenance flap fully.

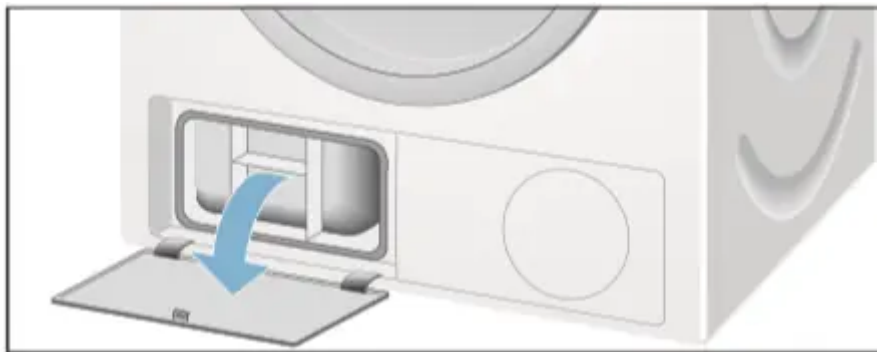

3. Turn both locking levers towards each other.

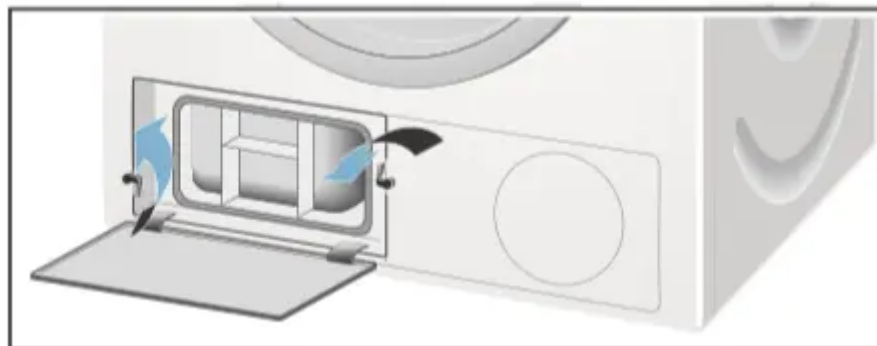

4. Remove the top cap from the heat exchanger.

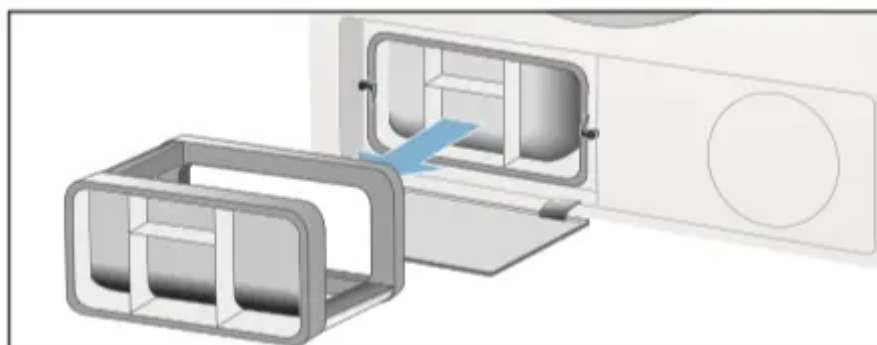

5. Remove the heat exchanger.

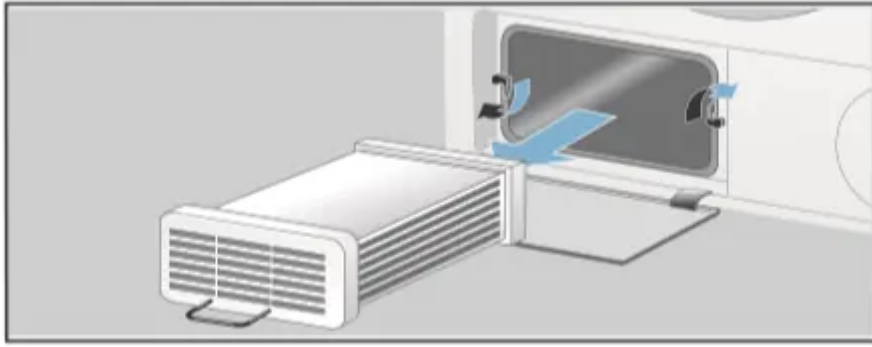

6. Flush water through the heat exchanger from all sides to completely remove all fluff.

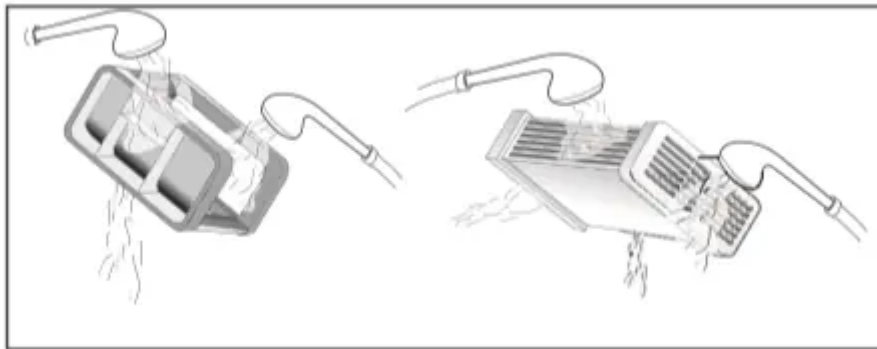

Caution!

There is a risk of damage to the heat exchanger.

Only use water to clean the heat exchanger, and do not use any hard objects or objects with sharp edges to remove the fluff.

7. Remove all fluff from the seals on the dryer and on the heat exchanger.
8. Allow all the water to drip off.
9. First insert the heat exchanger, and then fit the heat exchanger's top cap in place.
10. Turn both locking levers back and close the maintenance flap until it locks into place.

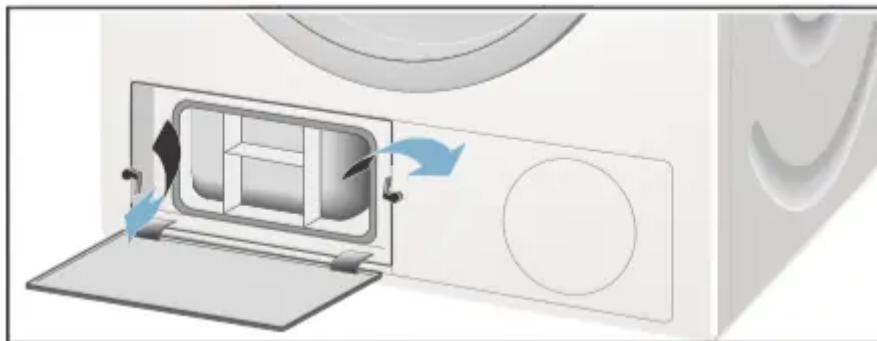

11. Close the maintenance flap and press on it until you feel it click in place.

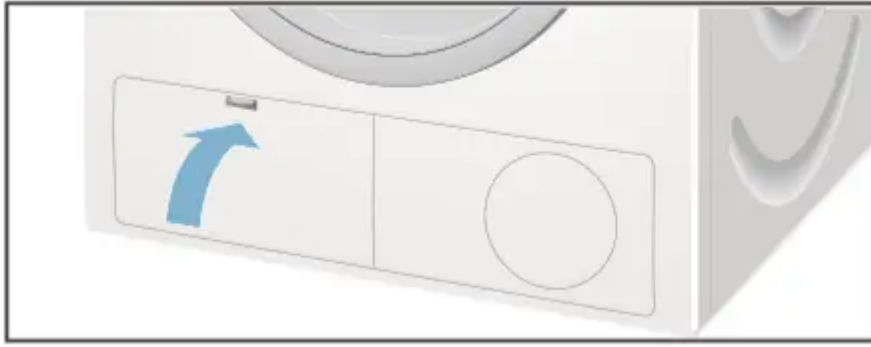

Cleaning the moisture sensor

Note: The dryer is equipped with a stainless-steel moisture sensor. The moisture sensor measures how damp the laundry is.

After long periods of usage the moisture sensor may become covered by a fine layer of limescale or residues of detergents and care products. Such residues must be removed regularly as the sensor function and in consequence the drying result may be impaired.



Open the door and clean the moisture sensor with a coarse sponge.



Caution!

Moisture sensor may be damaged. Do not clean moisture sensors with abrasives and steel wool.

Faults and what to do about them

Faults	Cause/remedy
 on the display panel and drying has been interrupted.	<ul style="list-style-type: none"> ■ Empty the condensate container and press the Start button → Page 28. ■ If the optional condensation drain is installed, the drain hose may be blocked. Check the hose for deposits and flush the hose out.
 on the display panel.	Clean the fluff filter and/or the heat exchanger, then select the Start button → Page 27; → Page 30.
Dryer does not start.	<ul style="list-style-type: none"> ■ Mains plug plugged in or fuse checked? ■ Programme selected? Select a programme. ■ Dryer door open? Close the door. ■ Childproof lock activated? Deactivate the childproof lock. ■ "Ready in" time selected? Programme starts after a delay.
Display panel goes off and Start button flashes.	Not a fault. Energy saving mode is active → Page 12.
Creasing.	<ul style="list-style-type: none"> ■ Creasing occurs when you have exceeded the maximum load or selected the wrong programme for the type of fabric. All the required information can be found in the programme table. ■ Remove clothes immediately after drying; creasing may occur if they are left in the drum.
Water is leaking out.	Not a fault; the dryer may be positioned on an incline. Level the dryer.
Change in the programme duration displayed during drying.	Not a fault. The moisture sensors detect the remaining moisture in the load and adjust the programme length (except timed programmes).

Laundry is not dried correctly or is still too damp.

- After the end of the programme, warm laundry feels damper than it actually is. Spread the laundry out and allow the heat to disperse.
 - Finely adjust the dryness level – this extends the drying time but does not increase the temperature. Your laundry will become drier → Page 24.
 - Select a programme with a longer drying time or increase the drying level. This does not increase the temperature.
 - Select a timed programme for subsequent drying of laundry that is still damp → Page 22.
 - If you have exceeded the maximum load for the programme, the laundry may not be dried properly.
 - Clean the moisture sensor in the drum. The sensor may become covered by a fine layer of limescale or residues of detergents and care products which then impair its function. Your laundry is not being dried correctly → Page 31.
 - Drying has been interrupted as a result of a power cut, because the condensate container is full or because the maximum drying time has been exceeded.
- Note:** See also the laundry tips → Page 21.

<p>Drying time too long?</p>	<ul style="list-style-type: none"> ■ The fluff filter may be dirty and cause a longer drying time. Clean the fluff filter. ■ If the air inlet on the dryer is blocked or not freely accessible, this may increase the drying time. Make sure that the air inlet remains unobstructed. ■ If the ambient temperature is higher than 35 °C, this may extend the drying time. ■ Insufficient air circulation in the room may increase the drying time. Venti- late the room.
<p>Humidity in the room increases.</p>	<p>Not a fault. Make sure the room is sufficiently ventilated.</p>
<p>Power cut.</p>	<p>The drying programme is interrupted. Remove the laundry and spread it out, or restart the programme.</p>

* Depending on the model

Note:

If you cannot rectify the fault yourself by turning the dryer off and on, please contact our after-sales service.

Warning

This content is compiled from multiple sources and is provided for reference purposes only. It may not be complete or fully applicable to all situations. If you are unable to resolve your issue, please contact the product manufacturer or an authorized service provider for official support.

