

Installation

Follow these instructions carefully to ensure a proper installation of this refrigerator and to prevent accidents before using it.

WARNING

- Use the refrigerator only for its intended purpose as described in this manual.
- Any servicing must be performed by a qualified technician.
- Dispose of the product packaging material in compliance with the local regulations.
- To prevent electric shock, unplug the power plug before servicing or replacing parts.

Refrigerator at a glance

The actual refrigerator and provided parts of your refrigerator may differ from the illustrations in this manual, depending on the model and the country.

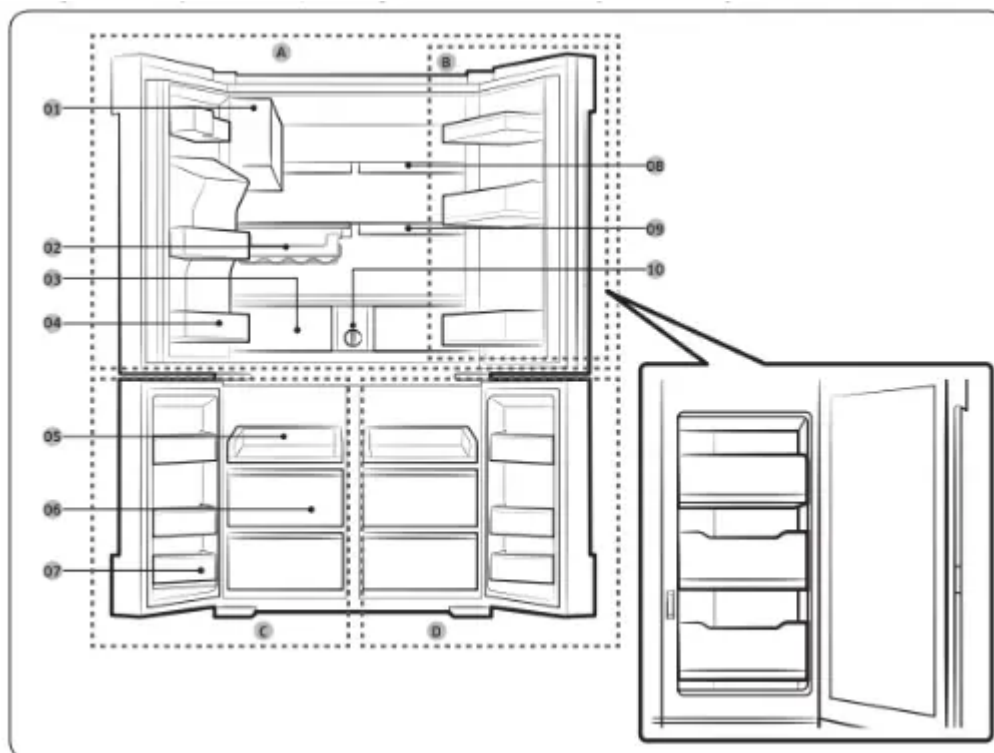

- 01 Auto Ice Maker
- 02 EZ Fresh Vegetable & Fruit Drawers
- 03 Fridge Multi-Purpose Guard
- 04 Easy Slide-Shelf
- 05 Dry Food and Meat Storage Drawers
- 06 Freezer door Bins

- 07 Fixed Shelf
- 08 Quick Space Shelf
- 09 Water filter
- 10 Wine Rack

- A. Fridge
- B. Showcase Door
- C. Freezer
- D. FlexZone

 **CAUTION**

- When the inner case is open, do not open the show case. The show case is likely to be pushed back and may be damaged.
- When closing the show case, make sure the show case is closed properly. If you close the show case properly, you will hear a clicking sound.

 **NOTE**

- For energy efficiency, keep all shelves, drawers, and baskets in their original positions.
- When closing the door, make sure the vertical hinged section is in the correct position to avoid scratching the other door.
- If the vertical hinged section is reversed, put it back into the correct position, and then close the door.
- Moisture may form at times on the vertical hinged section.
- If you close a door forcefully, the other door may open.
- If the internal or external LED lamp is out of order, contact a local Samsung service center.

Door removal for entrance

If the refrigerator cannot pass through the entrance to your home or kitchen due to its size, follow these instructions to remove and then re-install the refrigerator's doors. If you do not need to remove the doors, go to page 26 for the installation instructions.

Tools required (not provided)

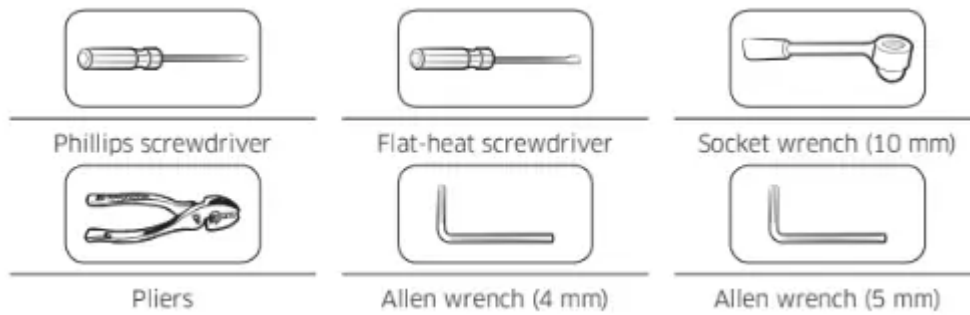

Detaching the fridge doors

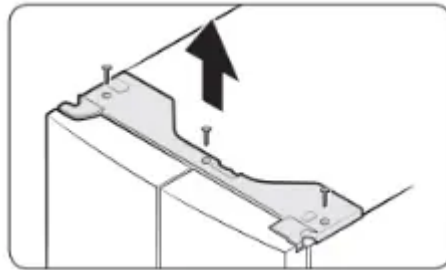

1. With the door closed, use a Phillips screwdriver to remove the screws (x3) from the top cover. Pull up and remove the top cover with the connectors.

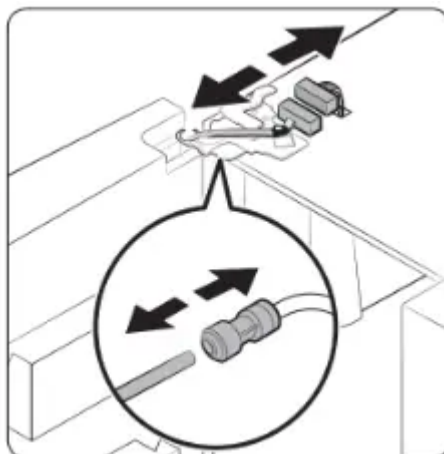

2. Disconnect the two wire connectors on the left door. The position of the connectors differs with the model.

CAUTION

- Do not remove both doors simultaneously. Make sure to remove one door at a time. Otherwise, any of the doors may fall and cause physical injury.
- Make sure the refrigerator is off before disconnecting the connectors.

3. Disconnect the water tube from the coupler on the left door as shown.

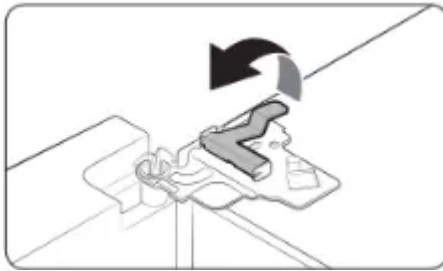

4. Gently draw up the clamp in several steps. To prevent finger injuries, do not apply a sudden force to the clamp.

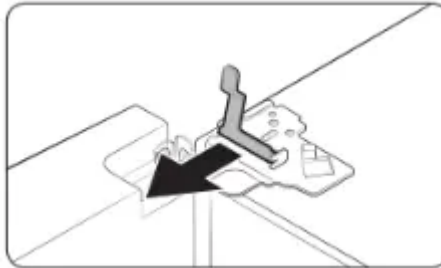

5. Pull up the clamp to remove.

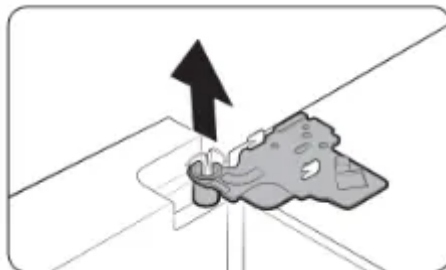

6. Open the door 90 degrees. While holding the door, pull up and remove the top hinge. Be careful not to damage the connector wires when you remove the hinge.

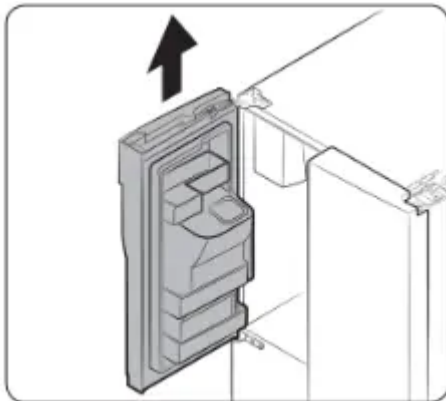

7. Gently pull up the door vertically to remove. Do not apply excessive force to the door. The door may fall, causing physical injury.

8. Lay the door down on a flat surface.

9. Repeat the steps above for the other door, except for Step 3. There is no water tube on the right side door.

Detaching the freezer doors

CAUTION

- Be sure to remove the fridge doors before removing the freezer doors.
- Use caution when disconnecting the bottom connectors.

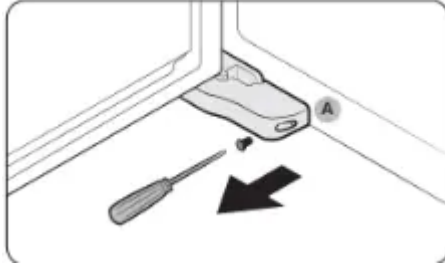

1. With the freezer door open, use a Phillips screwdriver to remove the screw holding the cover (A) of the adjustable leg.

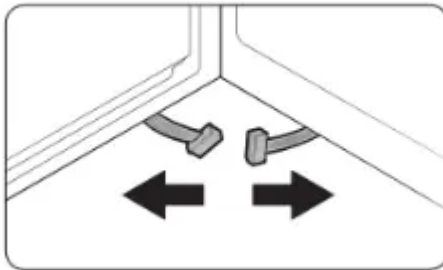

2. Disconnect the wire connectors.

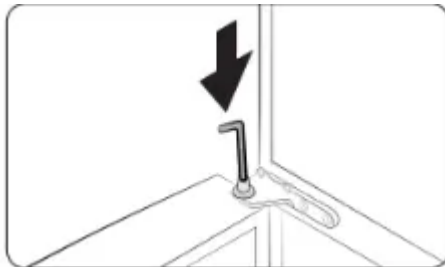

3. Locate the hinge shaft. While holding the door with one hand, use a flat-head screwdriver or wrench to press the shaft down. Make sure to hold the door to prevent the door from falling.

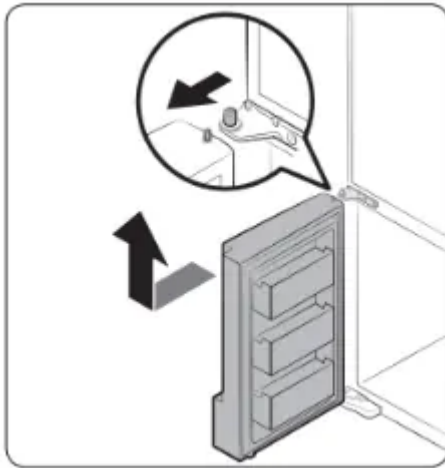

4. To prevent contact with the middle hinge, slightly tilt the door to the front, and then lift it up to remove.

5. Repeat the steps above for the other door.

Re-attaching the freezer doors

CAUTION

- Before re-attaching the doors, make sure all the electrical connectors are properly connected.
- The freezer doors must be re-attached before the fridge doors.
- Be careful not to damage or step on the wires during this process.

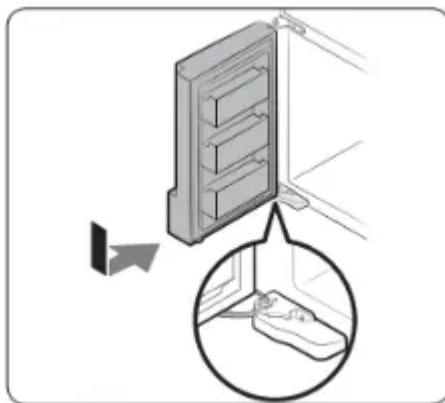

1. Insert the freezer door into the bottom hinge while pushing the freezer door in the direction of the arrow.

CAUTION

- Be careful not to damage or step on the wires during this process.

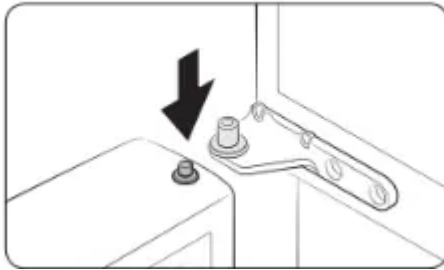

2. While pressing the hinge shaft down, position the door so that the hinge shaft is below the shaft hole in the middle hinge. Release the hinge shaft so that it enters the shaft hole.

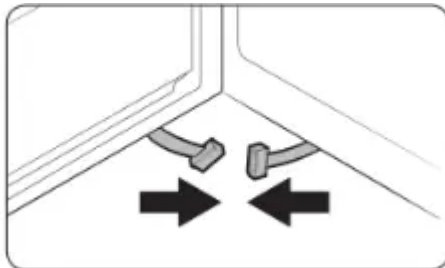

3. With the door open, connect the bottom connectors in the direction of the arrows.

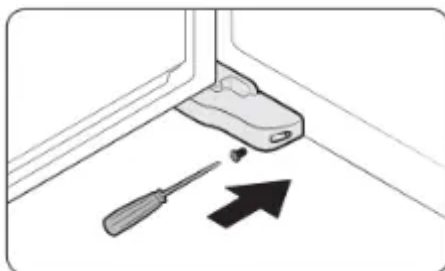

4. Attach the levelling foot cover using a Phillips screwdriver. Be careful not to damage or step on the connectors.

5. Repeat the steps above for the other door.

Re-attaching the fridge doors

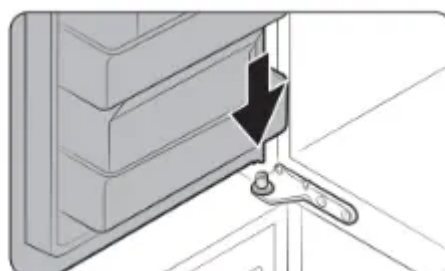

1. While holding the door open by more than 90 degrees, insert the shaft on the middle hinge into the hole on the bottom of the door.

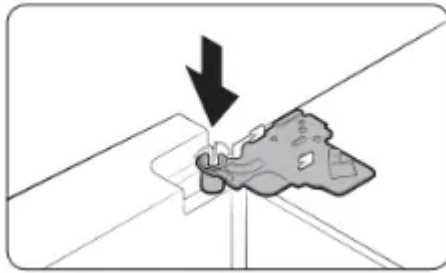

2. Put the top hinge into position on the top of the refrigerator, and then insert the hinge shaft into the top hole of the door. Make sure the wires from the door pass through the hole in the hinge shaft.

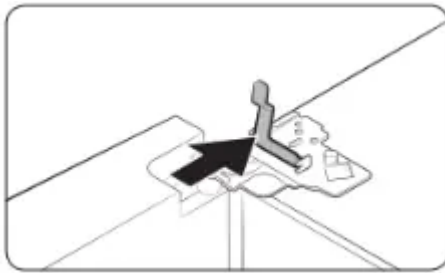

3. Insert the clamp in the direction of the arrow.

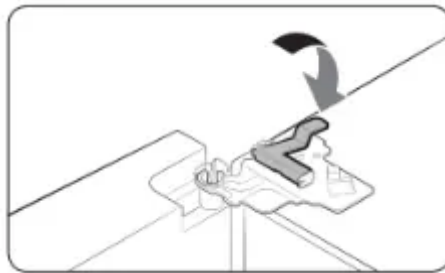

4. Push back the clamp as shown.

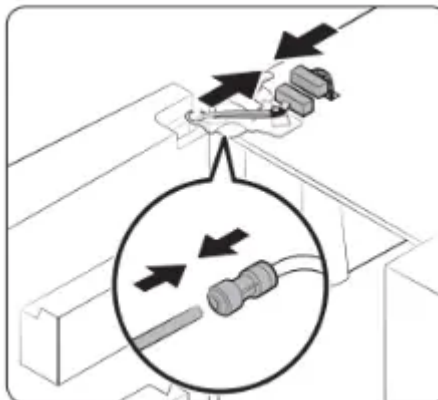

5. Connect the wire connectors.

 **CAUTION**

- Make sure the wire connectors are connected properly. Otherwise, the display will not operate.
- Connect the water tube.

⚠ CAUTION

- To prevent water leaks, make sure the red clips tighten the coupler properly.
- Keep the clips out of children's reach.

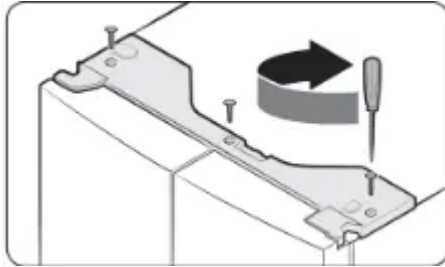

7. Repeat the above steps for the other door, except for Step 6. The right door does not have a water tube.

8. Attach the top cover with the front side first, and then press down on its back to get it into position. Then, tighten the screws (x3).

Step-by-step installation

STEP 1 Select a site

The site must:

- Have a solid level surface without carpeting or flooring that may obstruct ventilation
- Be out of direct sunlight
- Have adequate room for opening and closing the door
- Be away from any heat source
- Provide room for maintenance and servicing
- Have a temperature range between 50 °F (10 °C) and 110 °F (43 °C)

Clearance

See the pictures and table below and on the next page for installation space requirements.

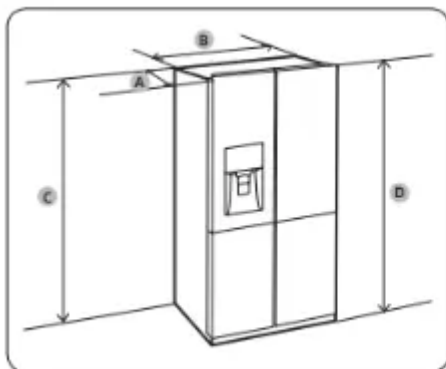

Depth "A"	34 1/4" (871 mm)
Width "B"	35 3/4" (908 mm)
Height "C"	70 3/4" (1797 mm)
Overall Height "D"	71 7/8" (1825 mm)

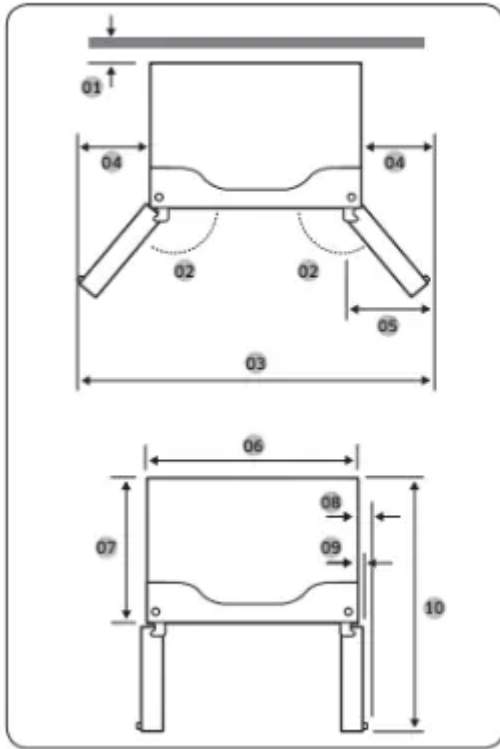

- 01 2" (50 mm)
- 02 125°
- 03 59 5/8" (1515 mm)
- 04 11 7/8" (303 mm)
- 05 12" (305 mm)
- 06 35 3/4" (908 mm)
- 07 24" (610 mm)
- 08 2 3/4" (70 mm)
- 09 1 3/4" (43 mm)
- 10 42 1/4" (1075 mm)

NOTE

The measurements of your refrigerator may differ from those listed above, depending on the measuring method.

STEP 2 Flooring

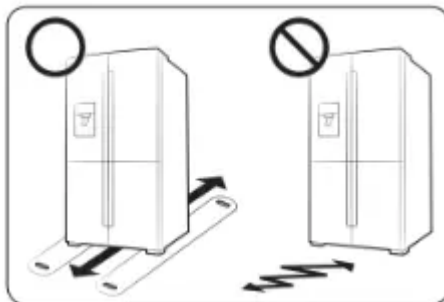

- The surface of the installation location must support a fully loaded refrigerator.
- To protect the floor, put a large piece of cardboard under each leg of the refrigerator when you move it for installation.
- To protect the floor once the refrigerator is in its final position, do not move it unless necessary. If you have to move it, place thick paper or cloth such as an old carpet, along the movement path.

NOTE



If the refrigerator cannot pass through entrance to your home or kitchen due to its size, see Door removal for entrance on page 18.

STEP 3 Adjust the levelling feet

CAUTION

- When installed, the refrigerator must be level on a flat, solid floor. Not leveling the refrigerator can cause damage to the refrigerator or physical injury.
- Levelling must be performed with the refrigerator empty. Make sure no food items are inside the refrigerator.
- For safety reasons, adjust the front side a little higher than the rear side.

You can level the refrigerator using the front legs. The front legs have a special screw (leveller) for levelling purposes. Use a flat-head screwdriver for levelling.

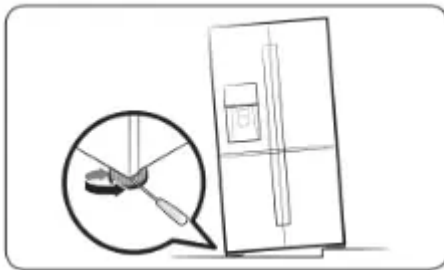

- To adjust the height of the freezer side: Insert a flat-head screwdriver into the leveller of the freezer-side front leg. Turn the leveller clockwise to raise the refrigerator. Turn it counterclockwise to lower.
- To adjust the height of the fridge side: Insert a flat-head screwdriver into the leveller of the fridge-side front leg. Turn the leveller clockwise to raise the refrigerator. Turn it counterclockwise to lower.

STEP 4 Adjust the door height and the door gap

Snap rings

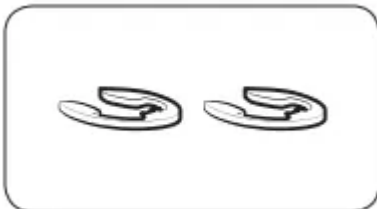

The height of a door can be adjusted using the provided snap rings, which come in 4 different sizes (1 mm, mm, 2 mm, and 2.5 mm).

To adjust the height of a door

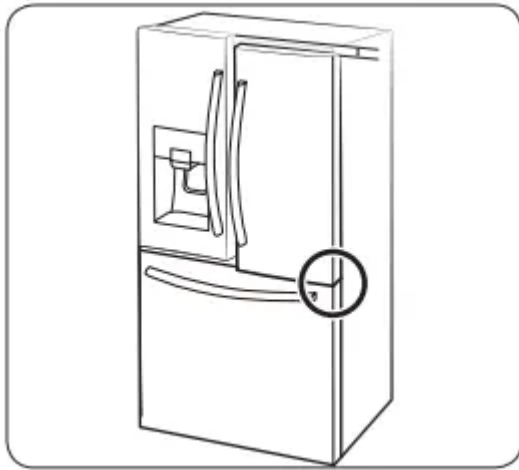

1. Check the height difference between the doors, and then lift up and hold the door with the lower height.

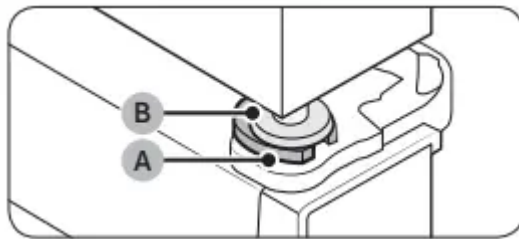

2. Insert a suitable-sized snap ring (A) between the door grommet (B) and the hinge as shown.

 **CAUTION**

- Insert only one snap ring. If you insert two or more snap rings, the rings may slip out or make a rubbing noise.
- Keep the snap rings out of children's reach and keep them for future use.
- Do not raise the door too much. The door can contact and damage the top cover.

To correct the door gap (applicable models only)

RF28K907*



Door gaps can be corrected using the gap bolt on the top right corner of the refrigerator.

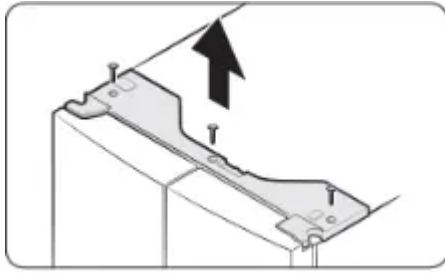

1. With the door closed, use a Phillips screwdriver to remove 6 screws on the top cover with the wire connectors.

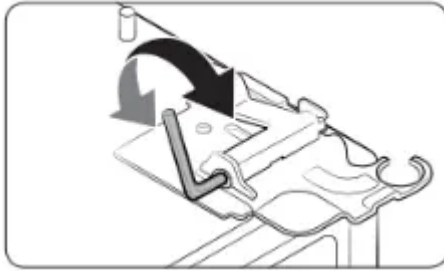

2. Use a 4 mm Allen wrench (not provided) to correct the door gap between two doors.

- To widen the gap, turn the gap bolt clockwise.
- To narrow the gap, turn the gap bolt counterclockwise.

3. When done, reinsert the top cover.

CAUTION

The electrical connectors must be left intact during this process. Use caution so you don't tangle the connector wires or peel off the coating.

STEP 5 Connect the water dispenser line

A water dispenser with a filter is one of the helpful features on your new refrigerator. To help promote better health, the water filter removes unwanted particles from your water. However, it does not sterilize or destroy microorganisms. You may need to purchase a water purifying system to do that. The water line also connects to the ice maker. For the ice maker to operate properly, water pressure of 30 to 120 psi (206 to 827 kPa) is required. If the refrigerator is installed in an area with low water pressure (below 30 psi / 206 kPa), you can install a booster pump to compensate for the low pressure. After you have connected the water line, make sure the water storage tank inside the refrigerator is properly filled. To do this, press the water dispenser lever until water runs from the water outlet.

NOTE

- Water line installation kits are available at extra cost from your retailer. We recommend using a water line installation kit that contains copper tubing and a 1/4" compression nut.
- Use the new hose-sets supplied with the appliance only. Do not re-use an old hose set.

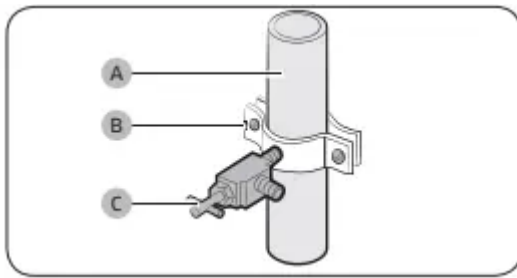

1. Shut off the main water source.
2. Insert the pipe clamp (B) and the shutoff valve (C) into the cold water line (A).

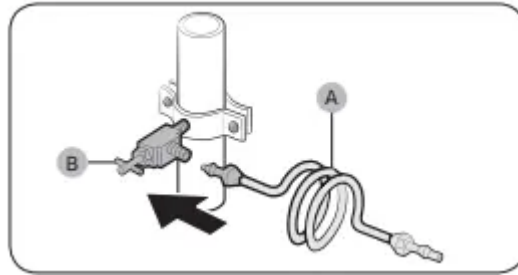

3. Connect the water line installation kit (A) to the shutoff valve (B).

Connect the water supply line to the refrigerator

There are several items you must purchase to complete this connection. You may find these items sold as a kit at your local hardware store.

Copper Tubing	<ul style="list-style-type: none"> • 1/4" copper tubing • 1/4" compression nut (1 pc) • Ferrule (2 pc)
Plastic Tubing	<ul style="list-style-type: none"> • 1/4" plastic tubing → Molded end (Bulb) • 1/4" compression nut (1 pc)

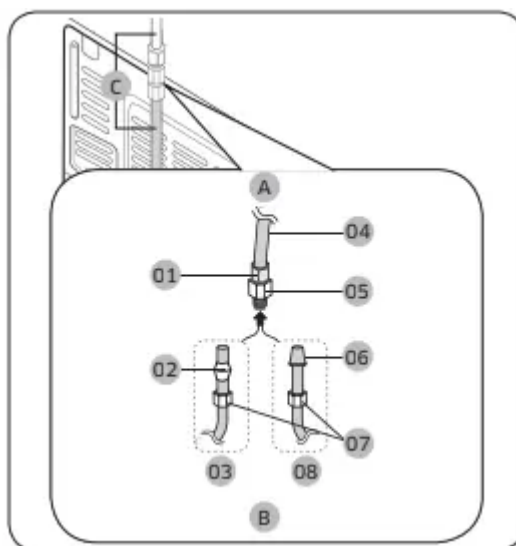

A. Refrigerator

B. Household water supply line

C. Water Line: must be kept straight.

1. Compression Nut (1/4") (Assembled)
2. Ferrule (Not supplied)
3. Copper tubing (Not supplied)
4. Plastic Tubing (Assembled)
5. Compression Fitting (Assembled)
6. Molded end (Bulb)
7. Compression nut (1/4") (Not supplied)
8. Plastic Tubing (Not supplied)

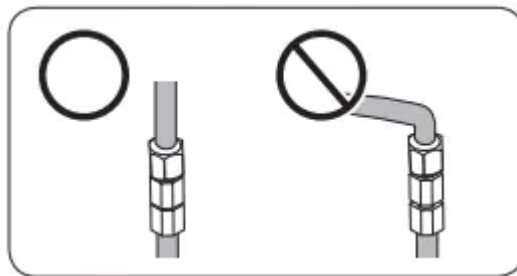

NOTE

If you have to relocate the refrigerator after connecting the water line (C), make sure the joined section of the water line is straight.

1. Connect the household water line to the assembled compression fitting.
 - If you are using copper tubing, slip the compression nut (B) (not supplied) and ferrule (not supplied) on the copper tubing (not supplied) as shown.
 - If you are using plastic tubing (A), insert the molded end (Bulb) of the plastic tubing (A) into the compression fitting.

CAUTION

If you use plastic tubing, (A) do not use it without the molded end (Bulb).

2. Tighten the compression nut (B) onto the compression fitting. Do not over-tighten the compression nut (B).
3. Turn the water on and check for any leakage. If you find water drops or leakage in the connection areas, turn off the main water supply. Check the connections and, if necessary, tighten.
4. Flush 1 gallon of water through the filter before drinking or using the water from the refrigerator. (Flush approximately 6 minutes.) To flush, press a large glass or cup against the water dispenser lever. Fill the glass, empty it, and then repeat.

5. After you turn on the refrigerator, let the ice maker make ice for 1 to 2 days. Over that period of time, throw out the first 1 or 2 buckets of ice the ice maker makes to ensure all impurities have been removed from the water line.

NOTE

Only connect the water line to a potable water source.

- If you have to repair or disassemble the water line, cut off 1/4" of the plastic tubing to make sure you get a snug, leak-free connection.
- You can test the water line quickly using a paper cup. Under normal conditions, the water dispenser can fill a 5 3/4 oz. (170 cc) cup in about 10 seconds.

STEP 6 Initial settings

After you complete the following steps, the refrigerator should be fully functional.

1. Plug the power cord into the wall socket to turn the refrigerator on.
2. Open the door, and check if the interior light lights up.
3. Set the temperature to the coldest setting, and then wait for about an hour. Then, the freezer will be slightly chilled, and the motor should be running smoothly.
4. Wait until the refrigerator reaches the set temperature. Now the refrigerator is ready to use.

STEP 7 Final check

When installation is complete, confirm that:

- The refrigerator is plugged into an electrical outlet and grounded properly.
- The refrigerator is installed on a flat, level surface with appropriate clearance between it and any walls or cabinets.
- The refrigerator is level and is sitting firmly on the floor.
- The door opens and closes freely, and the interior light turns on automatically when you open the door.

Operations

Feature panel

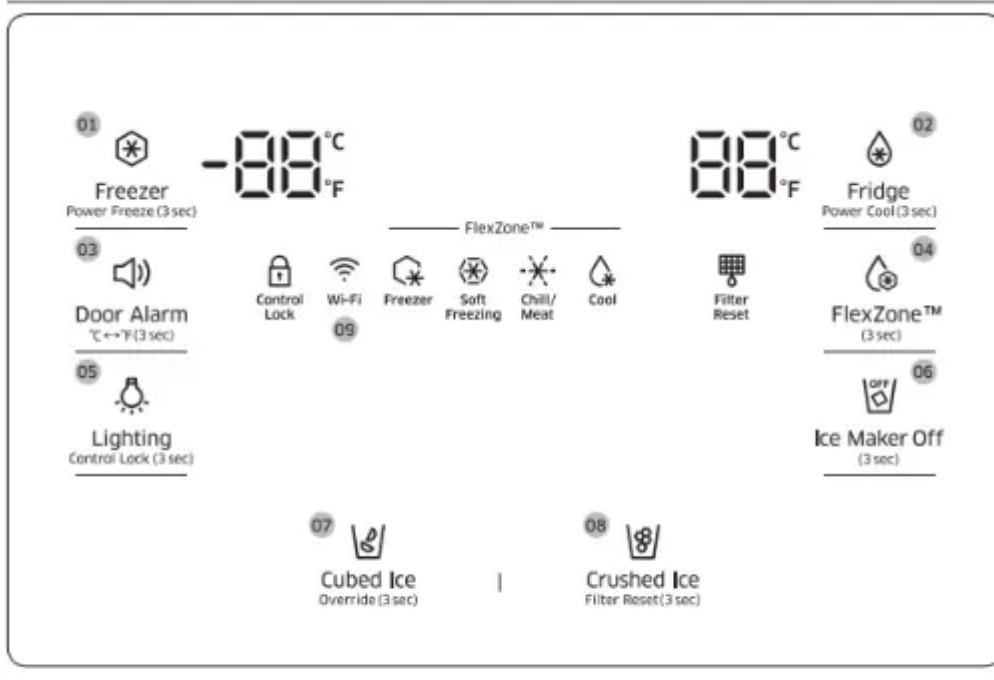

- | | | |
|----------------------------------|--------------------------------------|------------------------------|
| 01 Freezer / Power Freeze | 02 Fridge / Power Cool | 03 Door Alarm |
| 04 FlexZone | 05 Lighting / Control Lock | 06 Ice Maker Off |
| 07 Cubed Ice / Override | 08 Crushed Ice / Filter Reset | 09 Network connection |

NOTE

When you change the temperature on the panel, the panel displays the actual temperature inside the refrigerator until the temperature matches the temperature you set. Then, the panel displays the new set temperature. Note that it will take time for the refrigerator to reach the new temperature. This is normal. During this time, you need not set the temperature again.

01 Freezer / Power Freeze (3 sec)

Freezer

You can use the Freezer button to set the freezer temperature or to activate/deactivate Power Freeze. To set the freezer temperature, press Freezer repeatedly. Available temperatures are between 5 °F (-15° C) and -8 °F (-23 °C).

Power Freeze

Power Freeze lowers the freezer temperature and speeds up the freezing process. In Power Freeze mode, the freezer runs at full power for several hours and then returns to normal operation and the previous temperature setting.

- To activate Power Freeze, press and hold Freezer for 3 seconds. The corresponding indicator (❄) lights up, and the refrigerator speeds up the freezing process for you.
- To deactivate, press and hold Freezer for 3 seconds again. Power Freeze shuts off and the freezer returns to the previous temperature setting.
- To freeze large amounts of food, activate Power Freeze at least 20 hours before putting food in the freezer.

NOTE

Using Power Freeze increases power consumption. If you do not need the Power Freeze function on, make sure you turn it off so that the refrigerator can return to normal operation and the previous temperature setting.

02 Fridge / Power Cool (3 sec)

Fridge

You can use the Fridge button to set the fridge temperature or to activate/deactivate Power Cool.

To set the fridge temperature, press Fridge repeatedly to select a desired temperature between 34 °F (1 °C) and 44 °F (7 °C).

The temperature indicator displays the currently set or selected temperature.

Power Cool

The Power Cool function lowers the fridge temperature and speeds up the cooling process. In the Power Cool mode, the fridge runs at full power for several hours and then returns to normal operation and the previous temperature setting. Use Power Cool to rapidly cool food that spoils quickly or to rapidly cool the refrigerator after the door has been left open for some time.

To start Power Cool, press and hold Fridge for 3 seconds. The Power Cool icon lights and the refrigerator speeds up the cooling process.

To deactivate, press and hold Fridge for 3 seconds again. Power Cool turns off and the refrigerator returns to the previous temperature setting.

NOTE

Using Power Cool increases power consumption. If you do not need the Power Cool function on, make sure you turn it off so that the refrigerator can return to normal operation and the previous set temperature.

03 Door Alarm / °C ⇔ °F (3 sec)

Door Alarm

You can enable or disable the door alarm by pressing Door Alarm.

When Door Alarm is enabled and a door is left open for more than 2 minutes, the alarm will sound and the alarm indicator will blink. The Door Alarm function is enabled by factory default.

°C ⇔ °F

You can use the Door Alarm button to switch the temperature scale between Celsius and Fahrenheit.

To switch the temperature scale, press and hold Door Alarm for seconds.

04. FlexZone

With the FlexZone function, you can select an appropriate temperature for the food you have stored in the FlexZone compartment. The FlexZone compartment is located on the bottom right of the refrigerator. To initiate the FlexZone function, press and hold FlexZone for 3 seconds, and then press FlexZone repeatedly to cycle through the modes. When a desired mode is selected, release the button. The FlexZone function has the following four modes:

Freezer

Select Freezer to set the FlexZone compartment to the same temperature as the freezer.

Use to keep frozen food fresh.

Soft Freezing

Select Soft Freezing to set the FlexZone compartment to 23 °F (-5 °C).

Use to keep meat and fish fresh for an extended time.

Chill / Meat

Select Chill / Meat to set the FlexZone compartment to 30 °F (-1 °C).

Use when storing deli food such as steak, cold cuts, fish, bacon, and cheese.

Cool

Select Cool to set the FlexZone compartment to 41°F (5 °C).

Use when storing beverages that you will use fairly quickly or beverages you want to keep cold such as water, juice, soft drinks, and beer.

CAUTION

- When you switch or turn off this function, blood in meat or moisture in food may come out due to the temperature change.

- Do not store meat or food in the FlexZone compartment at the Cool setting. The meat or food may spoil.

NOTE

If the FlexZone button does not activate the function, make sure the button is unlocked. Press and hold Lighting/Control Lock for more than 3 seconds until the lock icon turns off. Then, press and hold FlexZone for more than 3 seconds to change the mode.

05 Lighting / Control Lock (3 sec)

Lighting

By default, the dispenser lamp turns on only when the dispenser is used. If you want to keep the dispenser lamp turned on (continuous mode), press Lighting. The lighting indicator also turns on. To restore the default settings, press Lighting again.

Control Lock

To prevent accidental setting changes, press and hold Control Lock for seconds. All controls will be disabled and the Lock indicator () will turn on.

When Control Lock is on, the refrigerator does not dispense ice or water, even if the Dispenser Lever is pressed.

To deactivate, press and hold again for 3 seconds. The Lock indicator turns off and the controls are re-enabled.

Device authentication

When connecting the refrigerator to Samsung Smart Home App or Samsung smart devices such as Samsung Smart TVs, follow the app's or device's onscreen instructions and press and hold Control Lock for seconds. The temperature panel displays "on" for 5 seconds before proceeding with the authentication procedure. Note that the Control Lock function will be not affected by this authentication.

06 Ice Maker Off (3 sec)

Ice Maker Off

To disable ice making, press and hold Ice Maker Off for 3 seconds.

In this mode, ice making is disabled even if you press Cubed Ice or Crushed Ice. To turn ice making back on, press and hold Ice Maker Off again for 3 seconds.

07 Cubed Ice / Override (3 sec)

Cubed Ice

You can select an ice type.

Press Cubed Ice to dispense cubed ice. The corresponding indicator turns on.

Override

The Override function activates/deactivates Smart Grid (See page 46).

Press Cubed Ice/Override for 3 seconds to set/clear the Override function.

08 Crushed Ice / Filter Reset (3 sec)

Crushed Ice

You can select an ice type.

Press Crushed Ice to dispense Crushed Ice. The corresponding indicator turns on.

Filter Reset

After about 6 months of using the original water filter (which typically amounts to about 320 gallons (1200 liters) of water), the Filter indicator blinks red to remind you that the filter needs to be replaced.

When this happens, replace the filter, and then press and hold Crushed Ice for 3 seconds. This resets the filter lifecycle detector and turns off the Filter indicator.



NOTE

- Some areas have relatively large amounts of lime in their water. This may reduce the lifecycle of the filter. In these areas, you will have to replace the water filter more often than specified above.
- If water is not dispensing properly, the water filter is most likely clogged. Even if the Filter indicator is not blinking, replace the water filter.

Cooling Off

Cooling Off mode (also called Shop mode), is designed for use by retailers when they are displaying refrigerators on the shop floor.

In Cooling Off mode, the refrigerator's fan motor and lights operate normally, but the compressors do not run so that neither the refrigerator or the freezer run the cooling process.

To enter Cooling Off mode, press and hold Fridge, Freezer, and Door

Alarm for 5 seconds. The refrigerator chime sounds with the message of "OFF" on the temperature panel.

To exit, press and hold again for 5 seconds.

09 Network connection

You can control and monitor your refrigerator through the Samsung Smart Home app. For more information, see the Samsung Smart Home section.

NOTE

- Recommended encryption systems include WPA/TKIP and WPA2/AES. Any newer or unstandardized Wi-Fi authentication protocols are not supported.
- Wireless networks may be affected by the surrounding wireless communication environment.
- If your Internet service provider has registered the MAC address of your PC or modem for identification, your Samsung Smart Refrigerator may fail to connect to the Internet. If this happens, contact your Internet service provider for technical assistance.
- The firewall settings of your network system may prevent your Samsung Smart Refrigerator from accessing the Internet. Contact your Internet service provider for technical assistance. If this symptom continues, contact a local Samsung service center or retailer.
- To configure the wireless access point (AP) settings, see the user manual of the AP.
- Samsung Smart Refrigerators support both Wi-Fi 2.4 GHz with IEEE 802.11 b/g/n and Soft-AP protocols (IEEE 802.11 n is recommended).
- Unauthorized Wi-Fi wireless routers may fail to connect to applicable Samsung Smart Refrigerators.

Samsung Smart Home

Installation

Visit the Google Play Store, Galaxy Apps, or Apple App Store and search for “Samsung Smart Home”. Download and install the Samsung Smart Home app provided by Samsung Electronics to your smart device.

NOTE

- The Samsung Smart Home app is designed for Android 4.0 (ICS) or higher, or iOS 7.0 or higher, and is optimized for Samsung smartphones (Galaxy S and Galaxy Note series).
- For improved performance, the Samsung Smart Home app is subject to change without notice, or discontinued support according to the manufacturer’s policy.

Samsung account

You are required to register your Samsung account to use the app. If you don’t have a Samsung account, follow the app’s onscreen instructions to create a free Samsung account.

Getting started

1. Run the Samsung Smart Home app and log in with your Samsung account. iPhone users are required to provide the login information each time they access the app.
2. Select Device > the + icon, and then tap Refrigerator.

3. Follow the onscreen instructions to provide the necessary information about the router, and then tap Next.
4. Press and hold Fridge for more than 5 seconds until the "AP" message appears on the freezer display. Your refrigerator will be registered with the app.
5. When device registration is complete, the refrigerator icon will appear on the Samsung Smart Home app.
6. Tap the refrigerator icon to open the refrigerator page.
7. When a network connection is established, the Wi-Fi icon lights up on your refrigerator.

Refrigerator app

Integrated control

You can monitor and control your refrigerator at home and on the go.

- Tap the refrigerator icon in the Samsung Smart Home to open the refrigerator page.
- Check the operation status or notifications related to your refrigerator, and change options or settings if necessary.

NOTE

Some options or settings of the refrigerator may not be available for remote control.

Key features

Register Samsung Smart Home appliances to the Samsung Smart Home server for remote access.

Menu overview

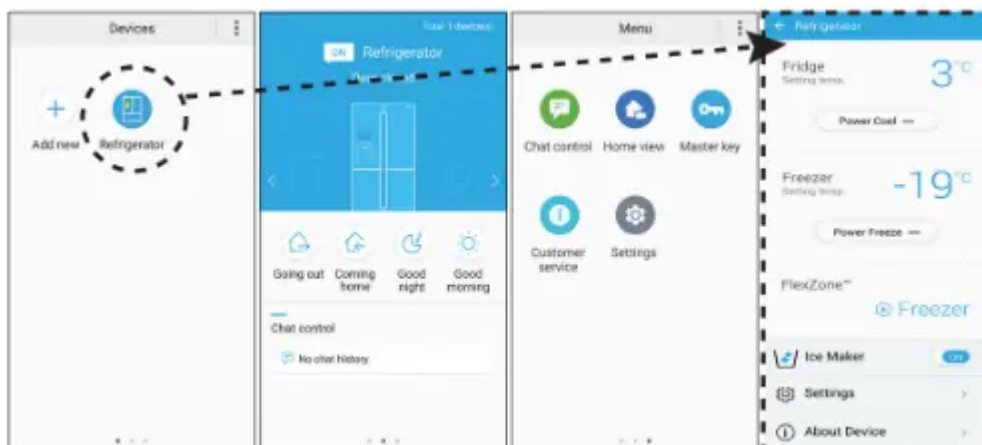

- Tap Refrigerator to open the settings page of the refrigerator.
- Swipe to move to the next page.

Chat control

You can control your Samsung Smart Home appliances remotely, or check the operating status.

Home view (applicable models only)

By using the built-in camera of a Samsung Smart Home appliance, you can monitor your living room. This is available only with applicable models.

Master key

The master key is designed to control the locking system for different user activities such as going out, coming home, going to bed at night, and waking up in the morning. This is available only with applicable models.

Customer service

The user manual is downloadable, and the contact information for customer support is also provided.

Settings

You can check the connected device as well as the software information (version and open-source licenses), and add devices or select a country.

You can simulate the operation of the current device for demonstration purposes.

Refrigerator settings

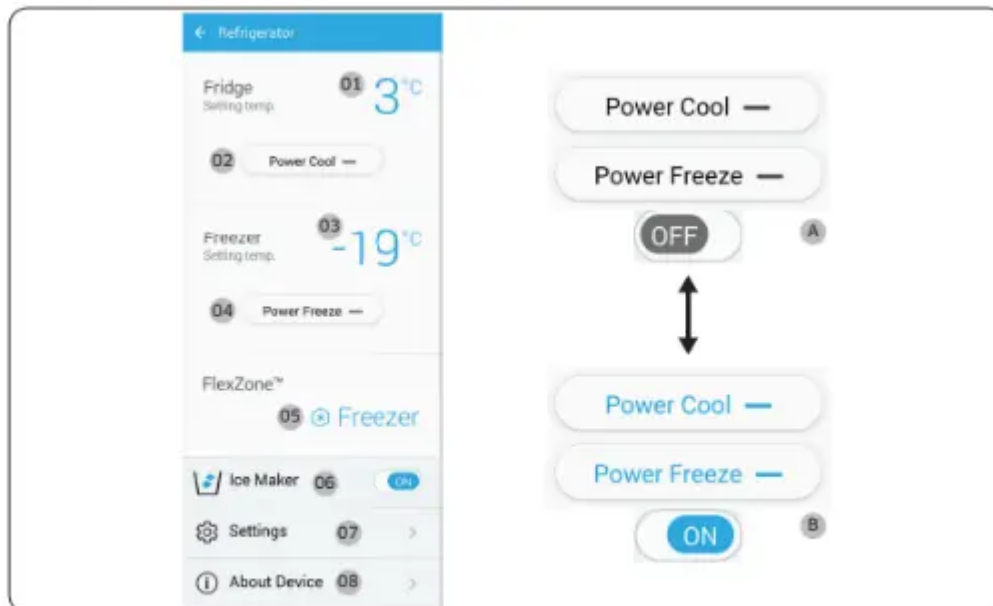

A: Disabled (black)

B: Enabled (blue)

Fridge

01 Displays the currently set fridge temperature.

02 You can turn on or off Power Cool, and check the current settings.

Freezer

03 Displays the currently set freezer temperature.

04 You can turn on or off Power Freeze, and check the current settings.

FlexZone™

05 Displays the current mode setting.

Ice Maker

06 You can turn on or off Ice Maker, and check the current settings as well as the ice making status.

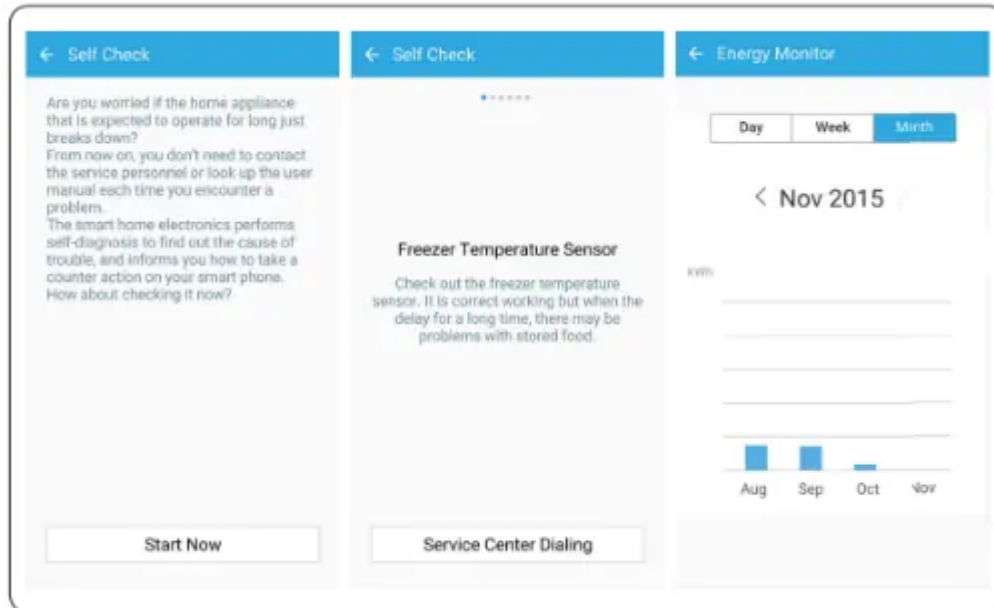

Settings

07. On the Settings screen, you can monitor the energy usage status of your refrigerator in a preferred format. Supported formats are daily, weekly, or monthly cumulative energy consumption reports covering a max of the last 180 days.

About Device

08. Displays the product information including the current version, tutorial, Self Check, and Help Desk. The user manual is downloadable, and the contact information for customer support is also provided.

Self Check

By referencing Self Check, you can check the diagnostic results of your refrigerator. If the refrigerator detects an issue to check, it displays detailed information about the issue that can be used for customer service.

SMART GRID Function (Demand Response)

When the refrigerator operates in SMART GRID (Demand Response) mode, the Energy Management Refrigerator function can control energy usage or delay the operation of some functions to save money when energy prices or demand are the highest.

NOTE

- You can deactivate the SMART GRID (Demand Response) function at any time using the (Override On/Off function.)
- To use the SMART GRID (Demand Response) function, you need a separate contract with your electric utility company.

In addition, to use the Smart Grid (Demand Response) function, you must register for the service with your electric company. The company must have an EMS (Energy Management System) that supports SEP (Smart Energy profile).

Using the SMART GRID (Demand Response) Function

This feature monitors energy prices and demand information from your utility company and sends notifications to the refrigerator to run high energy consuming tasks during off-peak times when electricity costs and demand are lower. If the refrigerator receives a control signal from the utility company, the refrigerator will display the DAL (L3) ~ TALR (L4) levels on the refrigerator display and control the power consumption according to the level.

[Exception condition] The DAL and TALR control signals from a utility company work as long as product performance is maintained. If the refrigerator receives the SMART GRID (Demand Response) signal (DAL or TALR), the refrigerator will operate in Delay Appliance Load (Display:L3) or Temporary Appliance Load Reduction (Display:L4) mode.

- Delay Appliance Load (L3): The refrigerator responds to a DAL signal by providing a moderate load reduction for the duration of the delay period. This function controls functions that consume a lot of energy such as adjusting the Cooling system, running the defrost cycle, and making ice.
- When the refrigerator operates in DAL (L3) mode, "L3" is displayed on the refrigerator display.
- DAL mode is automatically deactivated after it lasts for the amount of time stipulated by the DAL signal (max. 4.5 hours) or when the Override key is pressed.
- Temporary Appliance Load Reduction (L4): The refrigerator responds to a TALR signal by aggressively reducing the load for a short time period. This function reduces energy consumption by stopping the compressor and controlling the functions that consume a lot of energy such as the defrost cycle and making ice.
- When the refrigerator operates in TALR (L4) mode, "L4" is displayed on the refrigerator display.

- TALR (L4) mode is automatically deactivated after it lasts for the received duration max. 15 minutes), or when the Override key is pressed. The mode is immediately deactivated and the refrigerator returns to the normal state when the door is opened or closed, or the dispenser is used.

To check the MAC address

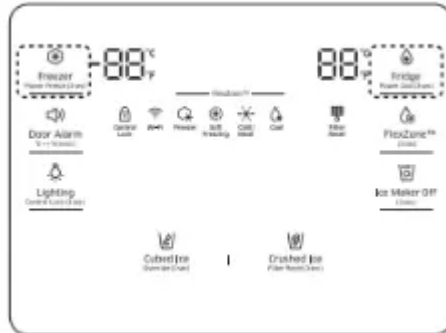

1. In this mode, the MAC address appears on the temperature panel (on both the freezer and the fridge sections of the panel) sequentially for 1 minute. Press and hold both Freezer and Fridge for 6 seconds. The temperature panel blinks. Then, press Freezer again to display the MAC address. The fridge beeps.
2. For example, if the MAC address is the temperature panel displays the address for 1 minute in this sequence: "-- / --" "11 / 22" After the 1 minute, the MAC address disappears and the temperature panel returns to the normal state.

NOTE

The temperature panel displays "-- / --" for an unknown MAC address or if a Wi-Fi connection is not established or is lost.

Override Mode

When you want the refrigerator to ignore the SMART GRID (Demand Response) signal from the utility company, you can activate OVERRIDE mode.

When you activate OVERRIDE mode, the refrigerator ignores the SMART GRID (Demand Response) signal and is not controlled by the utility company.

Activating and deactivating Override mode

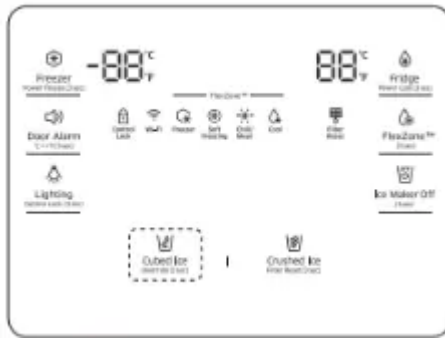

1. Press and hold Cubed Ice for 3 seconds.
2. A buzzer sounds and `Or` and `on` is displayed in the freezer and fridge temperature displays for 5 seconds.
3. If the refrigerator receives a SMART GRID (Demand Response) signal from the utility company, `Or` is displayed in the freezer temperature display.
4. To deactivate OVERRIDE mode, press and hold Cubed Ice for 3 seconds.
5. A Buzzer sounds and `Or` and `oF` is displayed on the fridge and freezer temperature displays for 5 seconds.

NOTE

- Alternatively, you can activate or deactivate OVERRIDE mode using the Samsung Smart Home app and the Energy Management function. See the next page.

Using the Energy Management Function

The Energy Management function enables you to control and monitor your Energy Management refrigerator using the Smart Home app for your convenience.

NOTE

To use the Energy Management refrigerator functions, you have to install the corresponding app first.

1. Operational Status

- You can check the DR and Override status.

2. Energy Consumption Reporting

- Shows the accumulated power consumption. Power consumption data is updated every 10 minutes.

NOTE

The energy consumption report may differ from the power consumption specifications of the product depending on the operating environment and the stored food.

3. Delay Defrost Capability

- The Delay Defrost Capability function saves energy by delaying the defrost operation to a time specified by the user. You can configure the time, and this function will save energy during the specified period in a 24-hour cycle. If the time is not set, the function works with the default time settings. The default time settings are below:
- 6 am to 10 am: 1st. November ~ 30th. April
- 3 pm to 7 pm: 1st. May ~ 31th. October

To change the time setting for the Delay Defrost Capability

You can change the time setting for the Delay Defrost Capability on the app.

Special features

The refrigerator has many convenient features.

Water dispenser

With the water dispenser, you can dispense water without opening the fridge door.

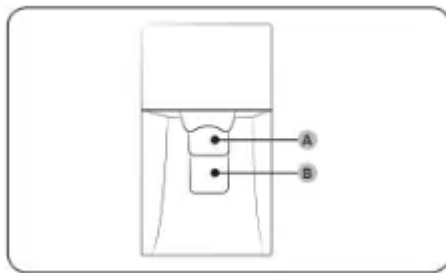

The water dispenser offers 3 options: chilled water, cubed ice, and crushed ice.

If you do not want to dispense ice, simply press the water lever (B).

With the Ice Maker enabled,

1. Press to select an ice type.
2. Put a water glass on the ice lever (A) and push it. Ice is dispensed from the dispenser.
3. Then, put the glass on the water lever (B) and push it. Water is dispensed from the dispenser.

NOTE

- To get ice and water, push the ice lever (A) first for ice, then move your glass down and press the water lever (B) for water.
- If you push both levers at once, only the first pushed lever operates.
- To prevent spills, wait 1 second before removing the glass after dispensing.
- Make sure the glass is in line with the dispenser to prevent the dispensed water from spilling out.

- If you do not use the water dispenser for 2-3 days, the dispensed water may have an abnormal smell or taste. This is not a system failure. Discard the first 1-2 glasses of water.

Ice maker

The refrigerator has a built-in ice maker that automatically dispenses ice so that you can enjoy filtered water with cubed or crushed ice to your preference.

Ice making

After you have installed your refrigerator and plugged it in, follow these instructions to ensure proper ice making and to keep the ice bucket full of ice:

1. Let the refrigerator operate for at least 24 hours to ensure optimal performance.
2. Dispense the first 4 to 6 ice cubes into a glass.
3. Wait another 8 hours and dispense another 4 to 6 ice cubes.
4. Then, wait another 16 hours and dispense the first glass-full of ice.



NOTE

- If you consume all the ice at once, you must wait 8 hours before dispensing the first 4 to 6 cubes. This ensures that the ice bucket is filled with ice properly.
- Ice cubes generated rapidly may look white, which is normal.

Diagnosis

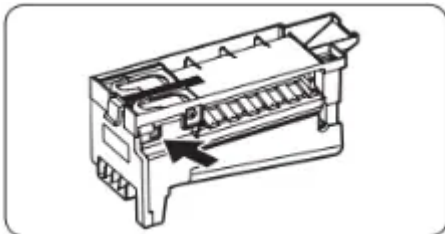

If ice does not dispense, first check the ice maker.

To check the ice maker

1. Press Test on the side of the ice maker. You will hear a chime (ding-dong) when you press the button.
2. You will hear another chime if the ice maker is operating properly.



CAUTION

- If the ice making chime rings repeatedly, contact the waterline installer or a local Samsung service center.
- Do not press Test repeatedly after the ice tray is filled with ice or water. Water may overflow or ice may jam.

- Do not put food in the ice bucket. The frozen food may damage the ice maker, especially when you open or close the door.
- When the refrigerator recovers power after a power failure, the ice bucket may contain a mix of melted and jammed ice cubes, which can prevent the ice maker from working properly. To prevent this, make sure to empty the ice bucket before using the refrigerator.
- Do not put fingers or any objects into the dispenser outlet or the ice maker. This can cause physical injury or property damage.
- When reinserting the ice maker tray, make sure that the tray is properly centered at the entrance. Otherwise, the tray can get stuck.

Ice Maker Off

If you press Ice Maker to turn the ice maker off, make sure to remove all ice cubes from the ice bucket. Remaining ice cubes may clump together, making it difficult to remove them.

To remove the ice bucket

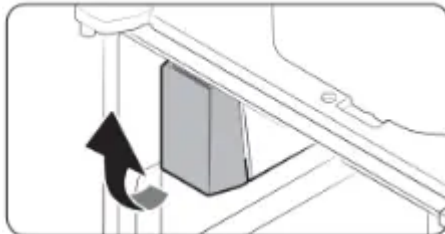

1. Hold the bottom of the ice bucket with one hand and hold the side with the other hand.
2. Gently lift it up and pull out.

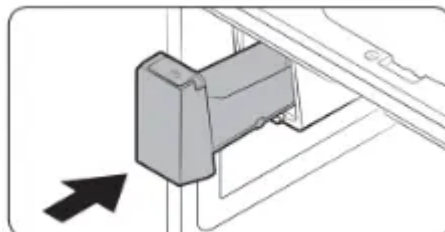

3. Remove the remaining ice cubes and put the ice bucket back into place.

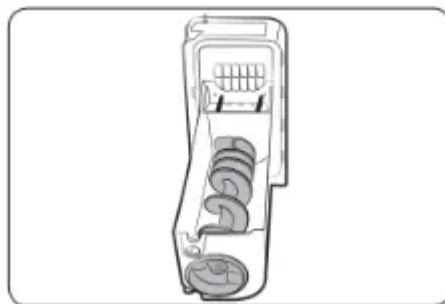

If the ice bucket is not firmly inserted, turn the ice screw 90 degrees, and then try again.

 **NOTE**

Removal of the ice bucket does not affect the thermal and mechanical performance of the refrigerator.

Water clouding

Water supplied to the refrigerator flows through a core alkaline filter. During this filtering process, the water pressure of the water increases and the water becomes saturated with oxygen and nitrogen. This causes the water to look misty or cloudy temporarily when dispensed. This is normal and the water will look clear after a few seconds.

Wine Rack

The refrigerator ships with the wine rack, which can be positioned in one of 3 positions: under the shelf, in the partition guide or on top of the sliding shelf of the FlexZone. Availability of the position depends on the model.

CAUTION

To remove or insert the wine rack, make sure that the wine rack is empty.

Under the shelf

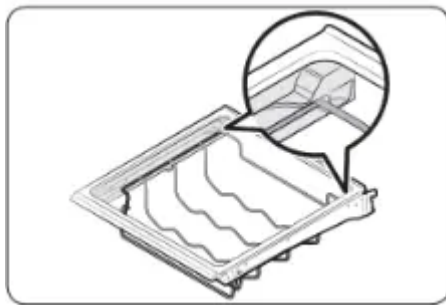

Insert the wine rack under the shelf of the fridge. Make sure to insert it to the end as marked in the figure.

In the partition guide

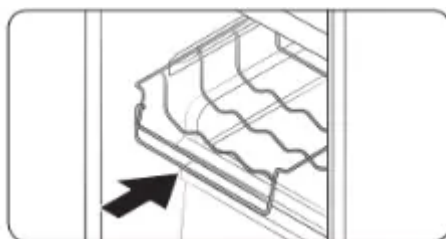

Insert the wine rack in the partition guide of the FlexZone.

- Make sure the front of the wine rack fits in the partition guide on the inner left-hand side of the FlexZone.

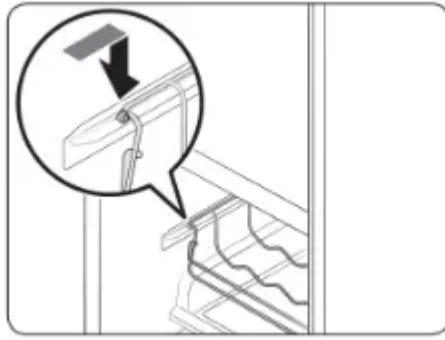

On the sliding shelf

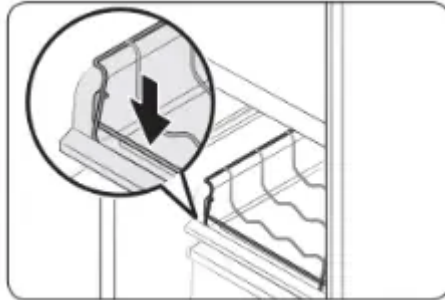

Insert the wine rack on top of the sliding shelf of the FlexZone, normally below the partition guide.

CAUTION

- Do not store wine bottles in the freezer. The bottles freeze and break, causing physical injury.
- Do not store wine bottles in two rows. The bottles may fall, causing physical injury.
- Do not store the wine bottles taller than 330 mm in height. The bottles may break when you close the door, causing physical injury.

Maintenance

Handling and care

Ice bucket (applicable models only)

If you do not dispense ice for an extended period, ice may form clumps inside the bucket. If this happens, remove and empty the ice bucket.

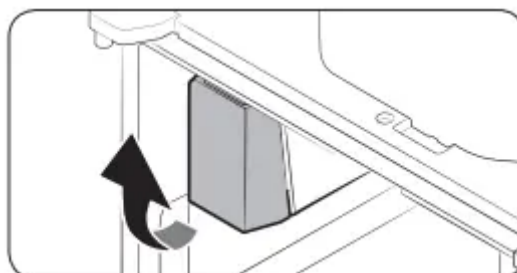

1. To remove the ice bucket, gently lift it up, and then pull it out slowly while holding the bottom of the bucket with one hand and the side with the other hand.
2. Empty the bucket.

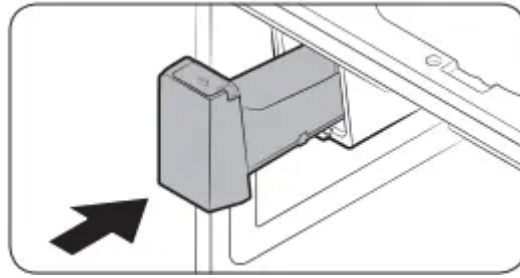

3. When done, put the bucket back into position. If the bucket does not fit in, turn the helix screw 90 degrees, and then try again.

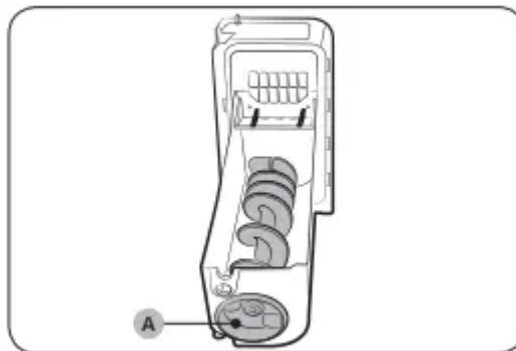

If the ice bucket is not firmly inserted, turn the Helix (A) 90 degrees, and then try again.

 **CAUTION**

- Do not apply excessive force to the bucket cover. The cover may break.
- Do not forcefully close the door. Water may spill over the ice maker.
- To prevent injury, make sure to clean up any ice or water that has fallen on the floor.
- To prevent accidents or injury, do not let children play with the water dispenser or the ice maker.
- Do not put your hand or an object into the ice chute. This may cause physical injury or product damage.
- Use only the provided ice bucket. Third-party ice buckets may cause a system failure.

 **NOTE**

- The water pressure required for ice making is between 30 to 120 psi (206 to 827 kPa).
- Noise from the ice maker as it produces ice during the ice making process is normal.
- While the door is open, neither the ice maker nor the water dispenser operates.

Tempered glass shelves (fridge)

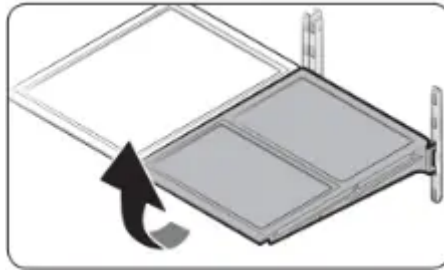

- To remove a shelf, fully open the corresponding door. Hold the front of the shelf, and then gently lift up and slide out.

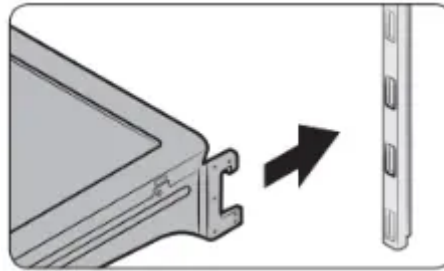

- To reinsert, hold the shelf at an angle so the front is higher than the back, and then insert the top hook into the top shelf notch. Then, lower the shelf and insert the bottom shelf hook into the bottom shelf notch.

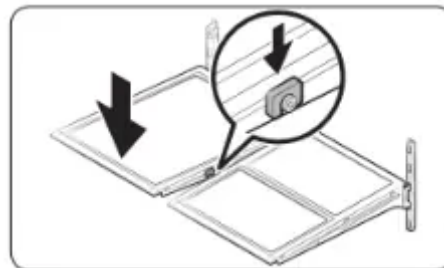

 **CAUTION**

- The tempered glass shelves are heavy. Use caution when removing them.
- The shelf must be inserted correctly. Do not insert upside down.
- Glass containers may scratch the surface of glass shelves.

Door bins

The top door bin section has a marked line to ensure easy removal and proper reinsertion.

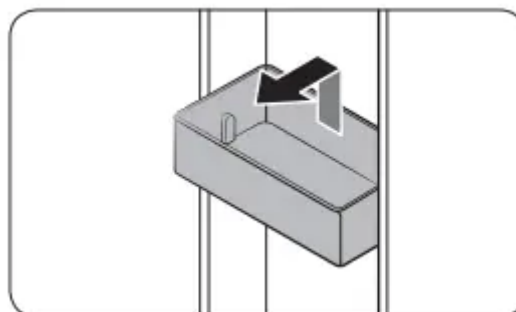

Lift up the door bin, and then pull out straight.



CAUTION

Do not allow children to play with the bins. Sharp-edged corners may cause injury.

Vegetable & fruit drawers (EZ fresh zone)

Gently lift up the front of the drawer and slide out.

We recommend that you remove the door bins before removing the drawer. This is to prevent damage to the door bins.

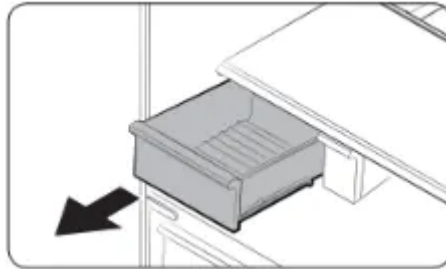

Vegetable shelf

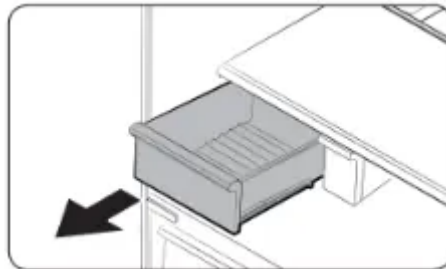

1. Slide out the left-side vegetable drawer.

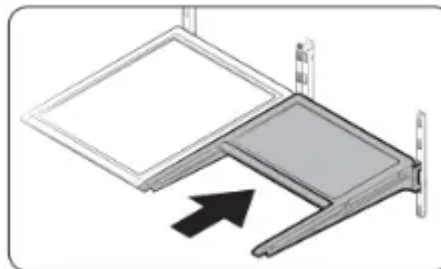

2. Slide in the right-side foldable shelf.

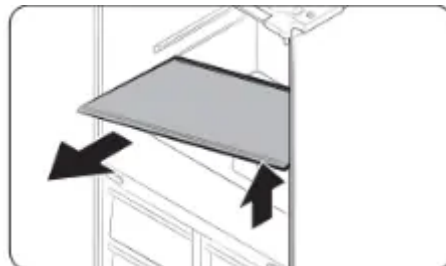

3. While supporting the vegetable shelf with one hand, slide it out with the other hand.

NOTE

To use the space that is opened up after removing the foldable shelf, take out the vegetable shelf.

To reinsert, follow the steps above in the reverse order.

Ice bucket

To remove the ice bucket, see the Maintenance section on page 53.

Cleaning

Interior and exterior



WARNING

- Do not use benzene, thinner, home/car detergent, or Clorox™ to clean the refrigerator. They may damage the surface of the refrigerator and cause a fire.
- Do not spray water onto the refrigerator. This may cause electric shock.

Regularly use a dry cloth to remove all foreign substances such as dust or water from the power plug terminals and contact points.

1. Unplug the power cord.
2. Use a moistened, soft, lint-free cloth or paper towel to clean the refrigerator's interior and exterior.
3. When done, use a dry cloth or paper towel to dry well.
4. Plug in the power cord.

Replacement

Water filter



WARNING

- Do not use third-party water filters. Use only Samsung-provided or -approved filters.
- Unapproved filters may leak and damage the refrigerator, causing electric shock. Samsung is not responsible for any damage that may occur from use of third-party water filters.

The Filter Reset indicator (**Filter**) turns red to let you know it is time to replace the water filter. Before replacing the filter, make sure the water supply line is shut off.

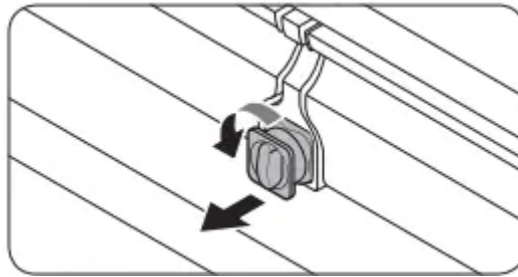

1. Shut off the water supply line.
2. Turn the knob of the filter cartridge 90 degrees counterclockwise (1/4 turn). The filter cartridge unlocks.

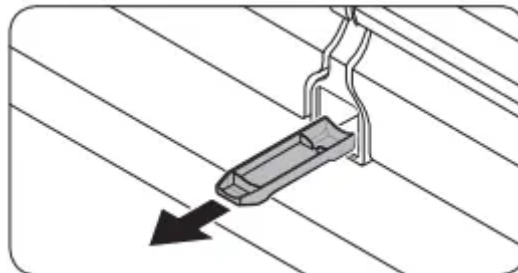

3. Pull out to remove the cartridge.
 - If the water filter is severely contaminated, the cartridge may not be easy to remove. If that is the case, use force to remove the cartridge.
 - To prevent water leaks from the filter opening, pull the cartridge straight out while removing it.
4. Insert a new filter cartridge. Use only Samsung-provided or approved filters.

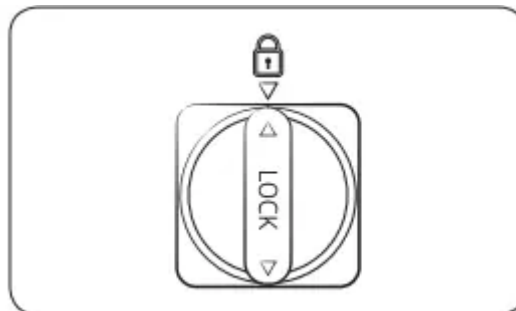

5. Turn the cartridge knob clockwise to lock into place.
6. Press and hold Ice Maker on the main panel for 3 seconds to reset the life cycle detector. The Filter Reset indicator turns off.
7. When you are done replacing the filter, open the water valve and run water through the dispenser for about 7 minutes. This is to remove impurities and air from the water line.

 **NOTE**

- A newly installed filter may cause the water dispenser to spurt water briefly. This is because air has entered the waterline.

- The replacement process may cause the water dispenser to drip for a short period of time. If it drips, simply wipe up any water on the floor with a dry towel.

Reverse osmosis water filtration system

The water pressure of the water supply system to a reverse osmosis water filtration system must be between 30 to 120 psi (206 to 827 kPa). The water pressure of the reverse osmosis water filtration system to the refrigerator's cold water line must be at least 40 psi (276 kPa).

If the water pressure is below these specifications:

- Check if the sediment filter in the reverse osmosis system is blocked. Replace the filter if necessary.
- Refill the water tank in the reverse osmosis system with water.
- If your refrigerator has a water filter, it may further reduce the water pressure when used in conjunction with a reverse osmosis system. Remove the water filter.

For more information or servicing, contact a licensed plumbing professional.

Ordering a new filter

To purchase a new water filter, contact a local Samsung service center or visit www.samsungparts.com on the web.

LED Lamps

To replace the lamps of the refrigerator, contact a local Samsung service center.



WARNING

- The lamps are not user-serviceable. Do not attempt to replace a lamp yourself. This can cause electric shock.

Troubleshooting

If you encounter a problem with the refrigerator, first check the tables starting below, and then try the suggested actions.

General

The refrigerator does not operate or cool.

- Make sure the power cord is connected properly.
- Make sure the temperature control is set correctly. Try setting to a lower temperature.
- Make sure the refrigerator is not being exposed to direct sunlight and is not near a heat source. Failing to do so may affect the cooling performance.
- Make sure the refrigerator is far enough away from rear walls, side walls, or cabinets to allow proper ventilation.

- Failing to do so may affect the cooling performance.
- Too much food can block the internal ventilation of the refrigerator. To keep the refrigerator operating normally, do not put too much food inside.

Food in the fridge freezes.

- Check if the temperature control is set to the lowest temperature. If so, change to a higher temperature.
- This can happen if the ambient room temperature is too low.
- Set the room temperature higher.
- Check if food containing a high proportion of water has been put in the coldest area of the fridge or near the cooling vent.
- If so, move the food to other shelves in the fridge.

You hear unusual noises or sounds.

- Make sure the refrigerator is installed on a stable, flat surface.
- Make sure the refrigerator is far enough away from rear walls, side walls, and cabinets to allow proper ventilation.
- Make sure that there are no foreign objects (coins, keys, cutlery, etc.) inside or underneath the refrigerator.
- The refrigerator may produce a ticking sound from inside.
- This occurs when the various accessories contract or expand as the temperature inside changes. This is normal.

The front corners and sides become warm and form condensation.

- To prevent condensation from forming, the refrigerator has heat-proof piping in the front corners. If the ambient temperature rises, this equipment may not work effectively. This is not a system failure.
- Make sure the door is closed properly. Condensation may form if you leave the door open for an extended period of time.
- Condensation may form on the exterior surface of the refrigerator if humid air comes into contact with the cool surface of the refrigerator.

The ice maker does not make ice.

- If you have used all the ice in the ice bucket, you must wait for 12 hours for the refrigerator to make more ice.
- See if the Ice Maker Off icon is lit. If it is, press and hold Ice Maker Off for 3 seconds.
- Make sure the freezer is set below 32 °F (0 °C) (or 23 °F (-5 C) in warm ambient air).
- Make sure the water line is properly connected and the shut- off valve is open.

- Check if the ice bucket contains ice clumps. If it does, empty the ice bucket and try again.

The water dispenser is not functioning.

- Make sure the water line is properly connected and the shut-off valve is open.
- Make sure the water supply line tubing is not damaged such as crushed or kinked.
- Make sure the water filter is installed properly.

You hear a bubbling sound.

- This is normal. The bubbling sound comes from refrigerant circulating through the refrigerator.

A bad smell comes from inside the refrigerator.

- Check for any spoiled food. We recommend cleaning the refrigerator on a regular basis and removing any spoiled or suspect food items.
- Make sure strong smelling food is wrapped tightly or stored in air tight containers.

Frost forms on the interior walls.

- Make sure the air vents are not blocked by food or any other objects so that the air can circulate freely. For efficient air circulation, it is recommended to arrange food items evenly.
- Make sure the door is closed properly.

Condensation or water drops form on or around the vertical mullion.

While the refrigerator is operating, condensation or water drops may form on or around the vertical mullion if the surrounding humidity is too high.

Samsung Smart Home

Could not find "Samsung Smart Home" in the app market.

- The Samsung Smart Home app is available for smartphones that run Android 4.0 (ICS) or higher, or iOS 7.0 or higher.

The Samsung Smart Home app fails to operate.

- The Samsung Smart Home app is available on applicable models only.
- The old Samsung Smart Refrigerator app cannot connect with Samsung Smart Home models. The Samsung Smart

Home app is installed but is not connected to my refrigerator.

- You must log into your Samsung account to use the app.
- Make sure that your router is operating normally.

- If the Wi-Fi icon on the refrigerator's display is off, this indicates that no network connection has been established yet. In this case, use the Samsung Smart Home app to connect and register your refrigerator to the access point (AP) of your house.

Could not log into the app.

- You must log into your Samsung account to use the app.
- If you don't have a Samsung account, follow the app's onscreen instructions to create one.

An error message appears when I try to register my refrigerator.

- Easy Connection may fail due to the distance from your access point (AP) or electrical interference from the surrounding environment. Wait a moment and try again.

The Samsung Smart Home app is successfully connected to my refrigerator but does not run.

- Exit and restart the Samsung Smart Home app, or disconnect and reconnect the router.
- Unplug the power cord of the refrigerator, and plug it again after 1 minute.

Smart Grid

What Do I Need to use the Energy Management and Smart Grid functions?

To use the Smart Grid (Demand Response) and Energy Management functions on your refrigerator, you need the following:

Devices

- Wireless access point (router)
- Samsung Energy Management-supported refrigerator
- Smartphone

Registration

- Connect your refrigerator to your home Wi-Fi network.
- Register for the EMS service with your electric company that has an EMS (Energy Management System) supporting SEP (Smart Energy profile).

Application

- Download the Samsung Smart Home app from the Google Play Store, Apple App Store, or Samsung Galaxy Apps.
- Install and run the Samsung Smart Home app on your smartphone.

Why isn't the Energy Management function working normally?

- Make sure that your home router is operating normally with proper Internet service and connection.

- Make sure that the refrigerator is connected to the AP.

Checkpoints

- Connect your smartphone to the router (AP, Access Point), and then check if you can browse the Internet on the smartphone.
- Check if the Wi-Fi icon on the refrigerator's display is on. If not, connect the refrigerator to the AP.

Why isn't the Delay Defrost Capability working normally?

- Make sure that your home router is operating normally with proper Internet service and connection.
- Make sure that the refrigerator does not display L3 or L4 on the display panel.

Warning

This content is compiled from multiple sources and is provided for reference purposes only. It may not be complete or fully applicable to all situations. If you are unable to resolve your issue, please contact the product manufacturer or an authorized service provider for official support.