

Getting started

Unit care

HDD/USB HDD handling care

- The HDD is a high precision recording instrument and is easily susceptible to damage. Therefore, be careful of the following points while the unit is turned on, especially during operation, otherwise the HDD and the recorded content may be damaged:
 - Do not subject the unit to any vibration and shock.
 - Do not remove the AC mains lead from the household mains socket.
- The HDD is a temporary storage device
 - It is recommended to save the recorded content on a disc or to keep the original data or CDs that they were copied from.
 - If you notice a problem with the HDD such as repetitive strange sounds, immediately save (backup) all content and request service. If you continue using the HDD with a problem, the unit or the recorded content will be damaged.
- If the HDD or USB HDD is damaged, the recorded content cannot be recovered.

Setup precautions

- Do not place on anything that generates heat like a Set Top Box, etc.
- Place in an area where condensation does not occur. Conditions where condensation may occur
 - When there is an extreme change in temperature.

In the above situation, without turning the unit on, let the unit adjust to the room temperature and wait 2–3 hours until condensation is gone.

- The unit may breakdown if cigarette smoke or bug spray/vapour, etc. gets inside the unit.

When moving the unit

Before moving the unit, ensure the disc tray is empty.

1. Switch the unit to standby mode. (Wait until “BYE” disappears from the display.)
2. Remove the AC mains lead from the household mains socket.
3. Move only after the unit has come to a complete stop (approx. 3 minutes) in order to avoid subjecting to vibration and shock. (Even after the unit is switched to standby mode, the HDD continues operating for a short time.)

Cleaning

- Wipe with a soft, dry cloth.
- Never use alcohol, paint thinner or benzine to clean this unit.
- Before using chemically treated cloth, carefully read the instructions that came with the cloth.
- Use the lens cleaner (not supplied) to clean the unit's lens.

When requesting this unit for repair

The registration of the USB HDD may be cancelled in the process of repairing this unit. You can use the USB HDD again by re-registering, but all recorded content already on the USB HDD will be lost. In such cases, the recorded content (data) cannot be recovered.

To dispose or transfer this unit

This unit may contain private information. Before disposing of or transferring this unit, perform the following to delete the data, including personal or secret information:

- Format HDD (-> 62)
- Perform "Shipping Condition" (-> 66)

Main unit

Front

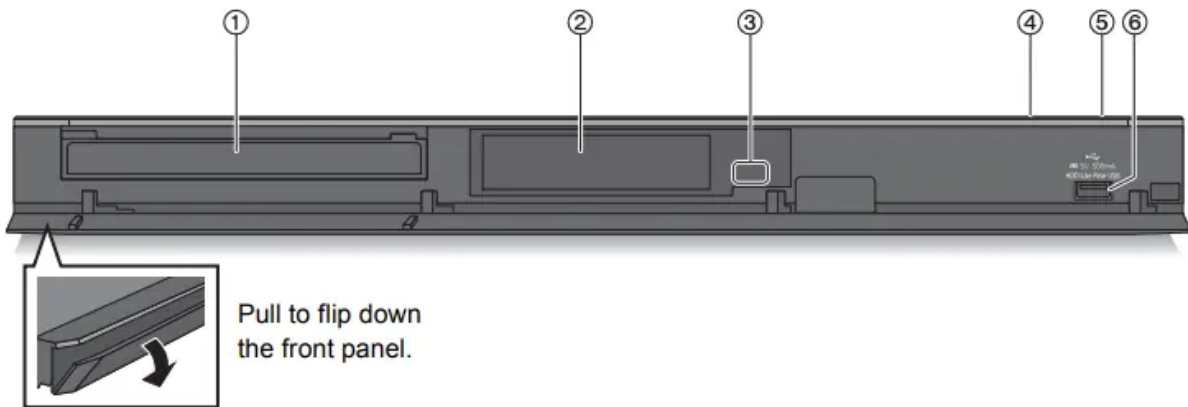

1 Disc tray

2 Display (→ 7)

3 Remote control signal sensor

- Angle: Approx. 20° up and down, 30° left and right
- Distance: Within approx. 7 m in front of the unit

4 Open/close disc tray

5 Standby/on switch (⏻/⏻) Press to switch the unit from on to standby mode or vice versa. In standby mode, the unit is still consuming a small amount of power.

6 USB port (DC 5 V 500 mA)

Inserting or removing media

Disc

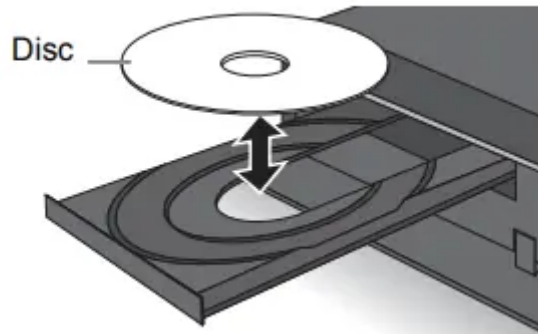

USB device

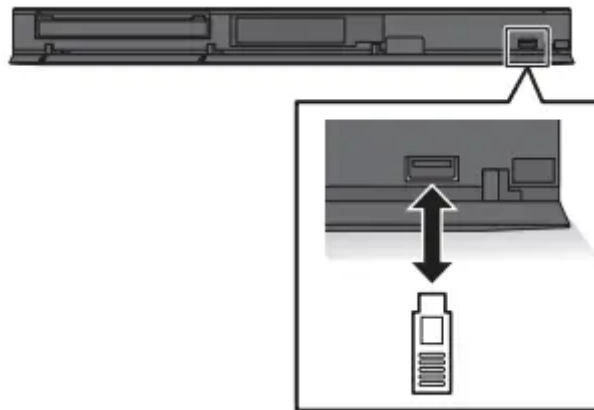

- While writing to/reading from the media, do not switch the unit to standby mode or remove the media. Such action may result in loss of the media contents.
- When inserting the media, ensure that it is facing the right way up.
- The USB port on the front side does not support USB HDDs. Connect a USB HDD to the USB port on the rear side. (⇒ 54, Connecting the USB HDD)

Display

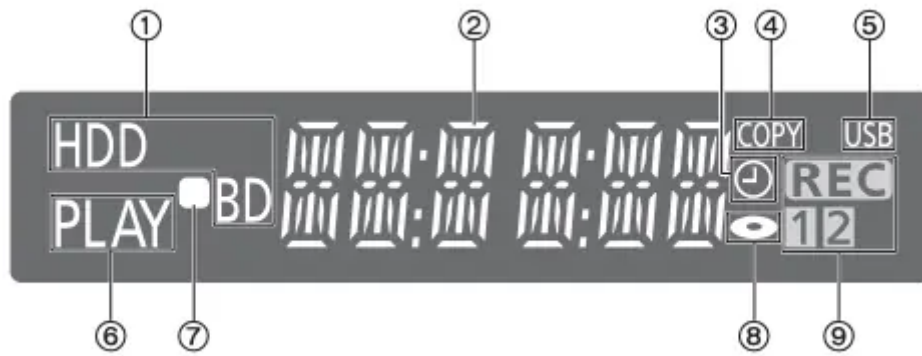

1 Drive (HDD or BD) indicator

2 Main display section indicator

- Messages and other information are displayed. (⇒ 71)

3 Timer recording indicator

This indicator lights up when the timer recording standby is activated.

4 Copying indicator

5 USB port indicator

6 Playback indicator

7 Remote control signal indicator

8 Disc indicator

9 Recording indicator

- “REC” lights up while recording is in progress.
- “1” flashes when the first timer recording standby is activated or recording is paused, and lights up while recording is in progress. (In the same way as “1”, “2” lights up or flashes for the second recording.)

Rear

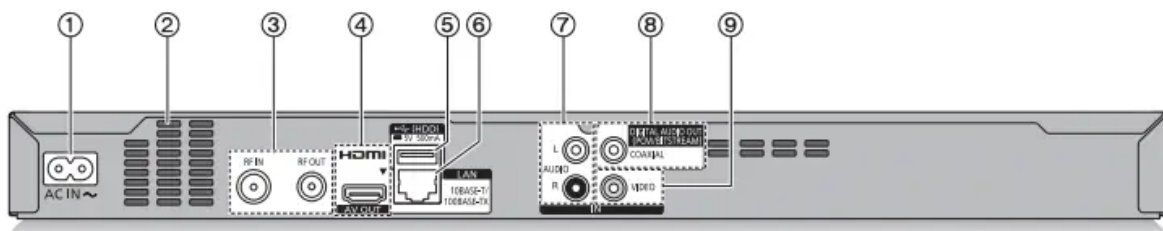

1 AC IN terminal (~)

2 Ventilation hole

3 RF IN/OUT terminal

4 HDMI terminal

5 USB port ( DC 5 V 500 mA)

- Connect a USB HDD to this USB port.

6 LAN port

7 AUDIO IN terminal

8 COAXIAL terminal

9 VIDEO IN terminal

 Class II equipment (The construction of the product is double-insulated.)

Remote Control

Instructions for operations are generally described using the remote control.

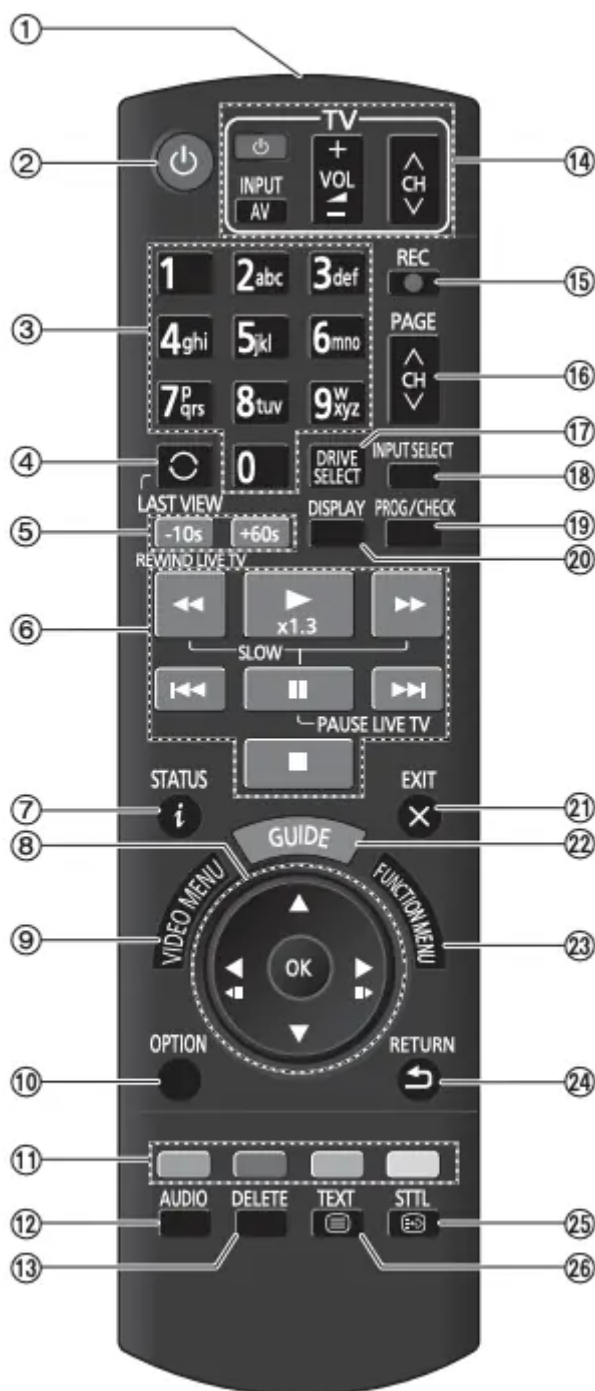

1 Transmit the remote control signal

- Point it at remote control signal sensor on this unit. (⇒ 6)

2 Switch the unit from on to standby mode or vice versa

3 Select channels and title numbers, etc./Enter numbers or characters

4 Switch to the previously watched channel (⇒ 19)

5 Manual skip (⇒ 33) -10s: Skip approx. 10 seconds backward +60s: Skip approx. 1 minute forward

- 6 Basic operations for recording and play, REWIND LIVE TV/PAUSE LIVE TV (⇒ 21)
- 7 Show Information (⇒ 19, 29, 32)
- 8 Selection/OK, Frame-by-frame (⇒ 32)
- 9 Show Video Menu, Top Menu, Pop-up Menu (⇒ 28, 33)
- 10 Show OPTION menu (⇒ 34, 36, 49)
- 11 Colour buttons (red, green, yellow, blue) (Use in accordance with instruction on the screen.)
- 12 Select audio (⇒ 20, 33)
- 13 To delete unwanted recorded titles, timer programmes, video, photo or music (⇒ 36)
- 14 TV operation buttons (⇒ 11)
- 15 Start recording (⇒ 22, 52)
- 16 Channel select (⇒ 19) Change pages in the Video Menu screen etc.
- 17 Select drive (HDD, Disc or USB)
- 18 Input select (⇒ 19, 52)
- 19 Show the Timer recording screen (⇒ 25)
- 20 Show Playback Menu (⇒ 34)
- 21 Exit the menu screen
- 22 Show the TV Guide screen (⇒ 20)
- 23 Show the FUNCTION MENU screen (⇒ 18)
- 24 Return to previous screen
- 25 Show subtitles (⇒ 19, 33)
- 26 Show Teletext (⇒ 19)

Connection

3D programmes can be played back when this unit is connected to a 3D compatible TV.

- Before connection, turn off all equipment and read the appropriate operating instructions.
- Use the High Speed HDMI cables. Non-HDMI-compliant cables cannot be utilized. It is recommended that you use Panasonic's HDMI cable.

When outputting 24p signal, please use HDMI cables 5.0 meters or less.

- When the unit is not to be used for a long time To save power, unplug it from the household mains socket. This unit consumes a small amount of power, even when the unit is in standby mode. (→ 72)

Basic connections

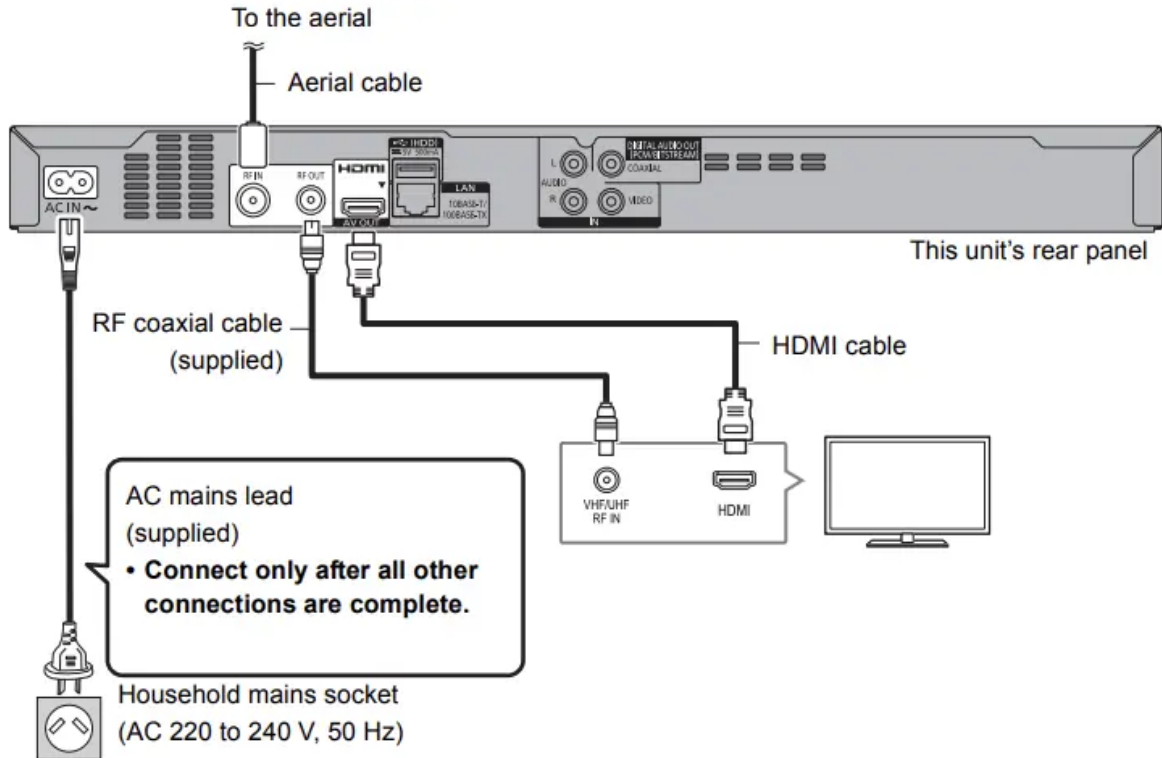

- Keep the RF coaxial cables as far away as possible from other cables.

Connect the Set Top Box or video equipment

- Connect to terminals of the same colour.

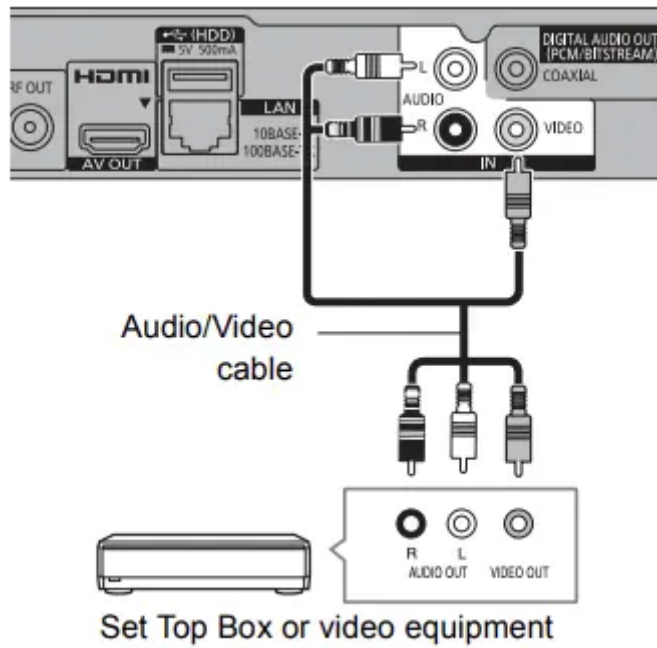

Amplifier/receiver connections

HDMI terminal

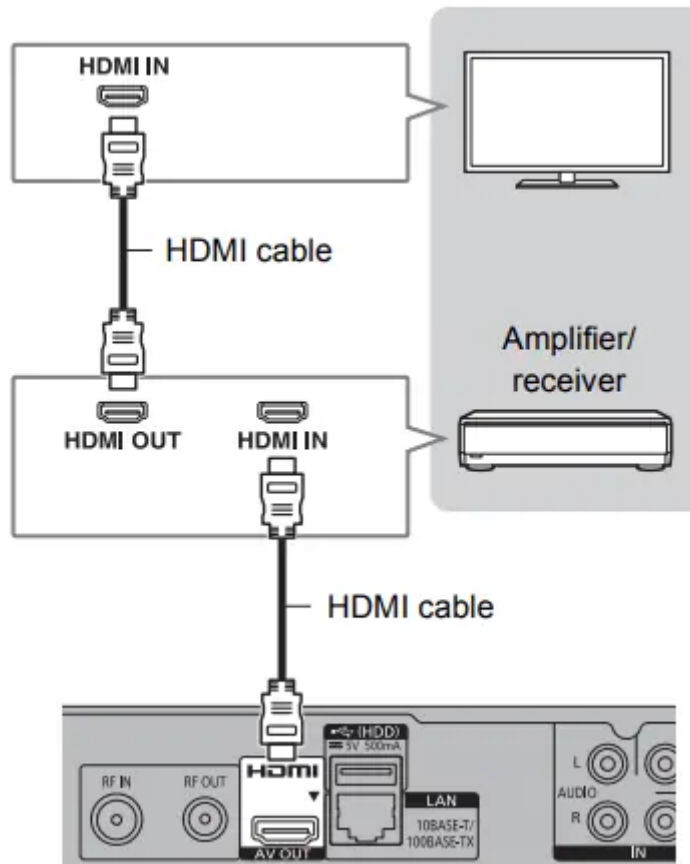

- You will not be able to view 3D programmes with this connection if your amplifier/receiver is not 3D compatible.



- When using a TV or an amplifier/receiver that does not display “ARC” on the HDMI terminal, it is necessary to connect the TV and the amplifier/receiver with a digital audio cable to enjoy the TV audio on the amplifier/receiver.

DIGITAL AUDIO OUT terminal

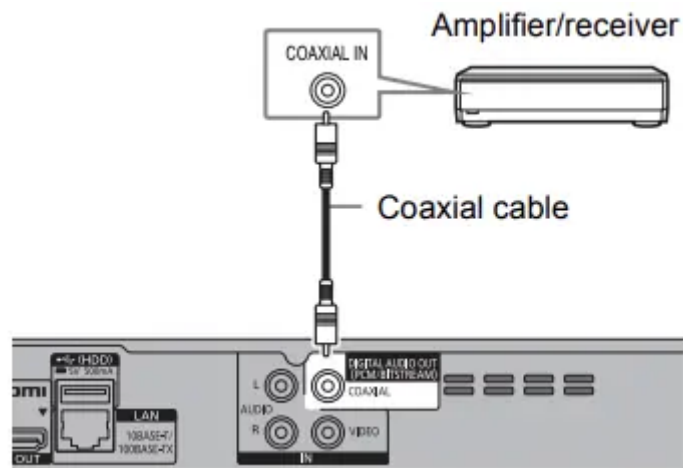

- When you do not want the audio to be output from the TV, set “HDMI Audio Output” to “Off” (⇒ 65).

Network connection

We recommend that you connect this unit to a network. By doing so, you can:

- Enjoy BD-Live
- Keep this unit up to date at all times through software (firmware) updates (⇒ 56, Software (Firmware) Update)

For details about connection method, refer to the instructions supplied with the connected equipment.

After you make the LAN cable connection, the network setting is needed. (⇒ 12, Easy Network Setting)

LAN cable connection

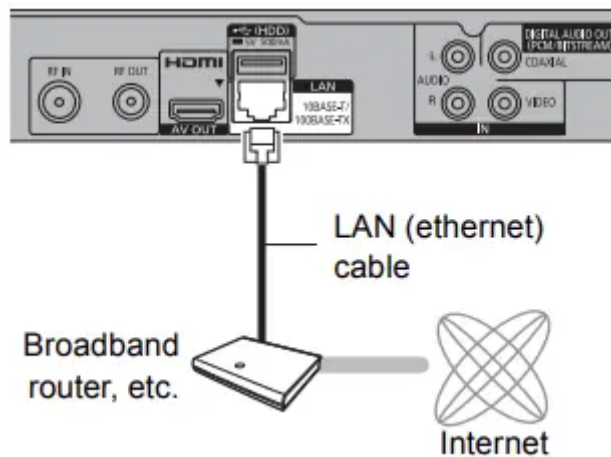

- Use category 5 or above straight LAN cables (STP) when connecting to peripheral devices.

Settings

TV operation buttons

The TV can be operated from the TV operation buttons of the remote control.

- Perform the setting if you cannot operate the TV with the TV operation buttons. While pressing [TV ], enter the code with the number buttons.



Manufacturer and Code No.

Manufacturer	Code	Manufacturer	Code
Panasonic	01/02/03/04	NEC	36
AIWA	35	NOBLEX	33
AKAI	27/30	NOKIA	25/26/27/60/61
BEKO	05/71/72/73/74	NORDMENDE	10
BENQ	58/59	OLEVIA	45
BRANDT	10/15	ONWA	30/39/70
BUSH	05	ORION	05
CENTREX	66	PEONY	49/69
CURTIS	05	PHILCO	41/48/64
DAEWOO	64/65	PHILIPS	05/06/46
DESMET	05	PHONOLA	05
DUAL	05	PIONEER	37/38
ELEMIS	05	PROVIEW	52
FERGUSON	10/34	PYE	05
FINLUX	61	RADIOLA	05
FISHER	21	SABA	10
FUJITSU	53	SALORA	26
FUNAI	63/67	SAMSUNG	32/42/43/65/68
GOLDSTAR	05/50/51	SANSUI	05
GOODMANS	05	SANYO	21/54/55/56
GRADIENTE	36	SCHNEIDER	05/29/30
GRUNDIG	09	SEG	05/69/75/76/77/78
HITACHI	05/22/23/40/41	SELECO	05/25
IRRADIO	30	SHARP	18
ITT	25	SIEMENS	09
JVC	17/30/39/70	SINUDYNE	05
KDS	52	SONY	08
KOLIN	45	TCL	31/33/66/67/69
KONKA	62	TELEFUNKEN	10/11/12/13/14
LG	05/50/51	TEVION	52
MAG	52	THOMSON	10/15/44
METZ	05/28/79	TOSHIBA	16/57
mitsubishi	05/19/20/47	WHITE WESTINGHOUSE	05
MIVAR	24	YAMAHA	18/41



- If your TV brand has more than one code listed, select the one that allows correct operation.
- If the brand of your TV is not listed or the code number is invalid for your TV, this remote control is not compatible with your TV.

Easy Setting

1. Turn on the TV, then select the appropriate AV input to suit the connections to this unit.
2. Press  on the remote control or  on this unit.
 - The Easy Setting will start at the initial power on.
3. Select the country you live in, and press [OK].

• **[For_Australia]**

If you select “Australia”, the “Region Selection” will appear. Select the region you live in, and press [OK].

• **[For_New_Zealand]**

If you select “New Zealand”, a screen asking you to restart this unit will appear. Press [OK] to restart it. Wait until a screen appears again. After the screen appears, Easy Setting resumes.

4. Follow the on-screen instructions and perform the settings.

Auto Setup starts.

(This operation may take some time.)

e.g., **[For_Australia]**

RF Ch	Channel Name	Type	Quality
35	○○○○	Digital TV	10
35	○○○○	Digital TV	10
Digital TV: 2			
Searching			

5. Clock is set automatically.

If the clock setting screen appears, set the time manually. (⇒ 66, Clock)

6. Set “Quick Start” to “On”, “Off” or “Timer Setting for Quick Start”, then press [OK]. For details, refer to “Quick Start”. (⇒ 65)

7. Select the aspect ratio that matches the connected TV.

For details, refer to “TV Aspect”. (⇒ 64)

When “Easy Setting has been completed.” appears, Easy Setting is completed.

- Select “Yes” to set network settings.
- Select “No” to finish the Easy Setting.

To stop partway

Press [RETURN 

To restart setup (⇒ 60, Auto Setup)











- If tuning is cancelled partway through, it may not be possible to receive the channels. Restart setup again.





Easy Network Setting

After Easy Setting is completed, select “Yes”. Easy Network Setting will start automatically. When “Easy Network Setting is finished.” appears Press [OK].

HDD and media information

For more details, refer also to the specifications. (⇒72)

Media type	Standard symbol	Recordable contents	Playable contents
Built-in hard disk drive (HDD)	 HDD	<ul style="list-style-type: none"> • Video • AVCHD/AVCHD 3D • MKV • MP4 • MPEG2 	<ul style="list-style-type: none"> • JPEG • MPO (3D photo) • AAC • MP3
External hard disk drive (USB HDD) (⇒ 16)	 USB HDD	<ul style="list-style-type: none"> • Video^{#1} 	<ul style="list-style-type: none"> • AVCHD/AVCHD 3D^{#2, 3} • MKV • MP4 • MPEG2 • JPEG • MPO (3D photo) • AAC • MP3
BD-Video	 BD-V	-	<ul style="list-style-type: none"> • Video
BD-RE BD-RE DL	 BD-RE	<ul style="list-style-type: none"> • Video • AVCHD/AVCHD 3D • JPEG • MPO (3D photo) 	
BD-R BD-R DL	 BD-R	<ul style="list-style-type: none"> • Video • AVCHD/AVCHD 3D^{#2} 	<ul style="list-style-type: none"> • MKV
DVD-Video^{#4}	 DVD-V	-	<ul style="list-style-type: none"> • Video
DVD-RAM	 RAM	<ul style="list-style-type: none"> • Video • JPEG • MPO (3D photo) 	<ul style="list-style-type: none"> • AVCHD^{#2}
DVD-R DVD-R DL	 DVD-R	<ul style="list-style-type: none"> • Video • AVCHD^{#2} 	<ul style="list-style-type: none"> • MKV • JPEG • MPO (3D photo) • AAC • MP3

Media type	Standard symbol	Recordable contents	Playable contents
DVD-RW 		DVD-RW - • Video	• AVCHD ^{※2}
+R/+R DL		+R - • Video	• AVCHD ^{※2} • AAC • JPEG • MP3 • MPO (3D photo)
+RW		+RW - • Video	• AVCHD ^{※2}
Audio CD (CD-DA) 		CD - • Music	
CD (including CD-R/RW)		- • MKV • AAC • JPEG • MP3 • MPO (3D photo)	
USB memory 	USB	- • AVCHD/AVCHD 3D ^{※2,3} • MKV • JPEG • MP4 • MPO • MPEG2 (3D photo) • AAC • MP3	

※1 It cannot be recorded directly. (Only compatible with copying from the built-in HDD)

※2 Recorded with AVCHD format compatible devices (Panasonic video camera, etc.). It may not be able to play back, add, or edit depending on the device.

※3 It cannot be played back directly from the USB HDD or USB memory. Playback is possible by copying to the built-in HDD. (⇒ 52)

※4 Includes finalised DVD-R, DVD-R DL, DVD-RW, +R and +R DL.



- **+RW** This unit cannot record to 8X Speed +RW disc.
- With certain recording states and folder structures, the play order may differ or playback may not be possible.
- It may not be possible to play the above media in some cases due to the type of media, the condition of the recording, the recording method, and how the files were created.

FUNCTION MENU screen

You can easily access the desired functions, such as playback, timer recording, the unit's settings etc. via the FUNCTION MENU.

1. Press [FUNCTION MENU].

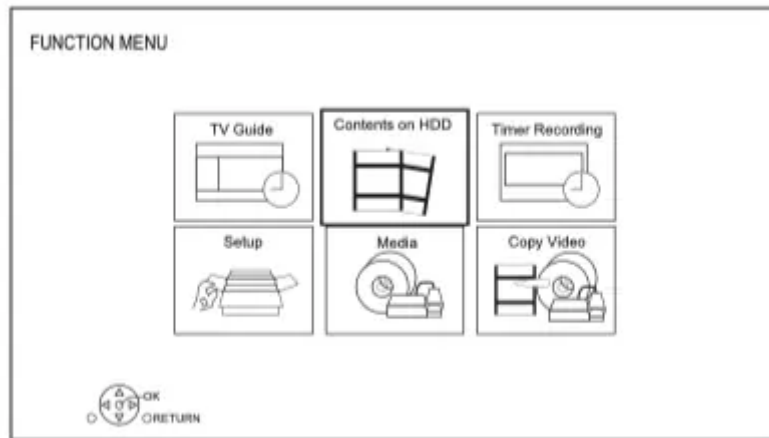



2. Select the item, then press [OK].

FUNCTION MENU list

- TV Guide (⇒ 20)
- Contents on HDD
 - Recorded Programmes(⇒ 28)
 - Video (AVCHD) (⇒ 28)
 - Video (MP4 / MKV) (⇒ 30)
 - Photo (⇒ 47)
 - Music (⇒ 51)
- Timer Recording (⇒ 25)
- Setup
 - Basic Settings (⇒ 60)
- You can change the unit's settings of Digital TV Tuning, Sound, Display, Connection, Network etc.
 - Wallpaper Personalise a background of the FUNCTION MENU.
- To select from among "Photo", register photo in advance. (⇒ 47)
 - BD-Video Data Management (⇒ 31)
- Media
 - Disc
 - USB device
 - USB HDD
- Copy Video

- Copy Menu (⇒ 42)
- Copy Video (AVCHD) to DVD-R (⇒ 46)

Watching broadcasts

1. Press [INPUT SELECT] and select “TV”, then press [OK].
2. Press [CH  ] to select the channel.

- You can also select the channel by the following operations

- Using number buttons.
- Using Channel Information (⇒ below)
- Using TV Guide system (⇒ 20)
- Using Channel List (⇒ 21)

To switch to the channel you have previously watched

Press [LAST VIEW ].

- This function will work only for the channels you have watched for more than 10 seconds.

If this unit requests a PIN

If you have set a ratings level (⇒ 61, Child Lock (Parental Rating)), you may be asked to enter the PIN. In that case, enter the 4-digit PIN with the number buttons by following the on-screen instructions.

- Make a note of the PIN you have decided on in case you forget it.
- PIN can be changed via “PIN Entry”. (⇒ 66)

Using Channel Information

While watching a programme

Press [STATUS ].

Channel Information appears.

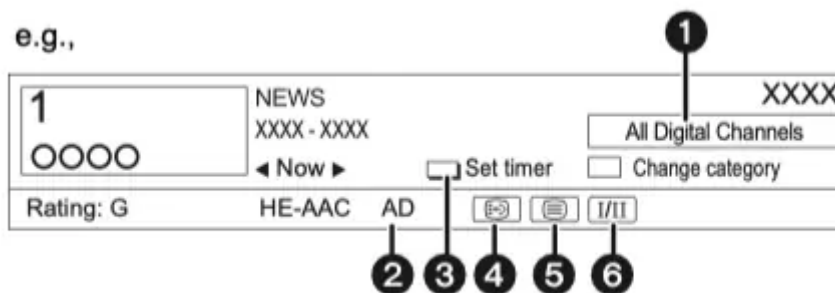

- 1 Current Category
- 2 [For_New_Zealand] Audio Description
- 3 Set timer (⇒ 26)
- 4 Subtitle
- 5 Teletext
- 6 Multiple audio

To show detailed information

Press [STATUS ] again.

To hide the information screen

Press [EXIT ].

To change Category



Press the blue button.

- To register your favourite channels (⇒ 60)

To switch between the current programme and the next programme

Press [, ].

To switch to another channel

Press [, ], then press [OK].

To show subtitle

When “” appears in Channel Information





Press [STTL ].

- Press again to hide subtitle.

To show Teletext

When “” appears in Channel Information

1. Press [TEXT ].

2. Use [, , , ], number buttons or colour buttons, etc. according to on-screen instructions.



- You can change the display mode. (⇒ 64, Teletext)

Switching audio

Press [AUDIO].

- Audio will switch according to the contents of the programme every time it is pressed.

[For New Zealand]

To listen to the Audio Description When “AD” appears in Channel Information (⇒ 19)

Audio Description adds an additional soundtrack to describe events on screen (narration) and aids understanding and enjoyment, particularly for visually-impaired viewers.

Press [AUDIO] to select the soundtrack of Audio Description.



- If “Audio Description” is set to “Automatic”, Audio Description will be given priority when watching, if available. (⇒ 61)

Aspect

You can switch the aspect ratio of the screen mode. (⇒ 59)

Using TV Guide system

1. Press [GUIDE]. TV Guide screen appears.

e.g. Landscape view

[For Australia]

TV Guide		Landscape		Category: All Digital Channels	
TUE 05.01.2016		XXXXXX		XXXXXX	
XXXXXX - XXXXXX		Skillful workman		▶	
TUE 05.01	XXXXXX	XXXXXX	XXXXXX	XXXXXX	XXXXXX
1 ○○○○	Skillful workman		Penguin		
2 ○○○○	Kitten	House dog		Will	
3 ○○○○	Vacation	Hunting			
4 ○○○○	Pampas grass		News	Top run	
5 ○○○○	News	Com	Shopping		Area 91
6 ○○○○	Venus		Moon		
7 ○○○○	Construction		Hippopotamus		
8 ○○○○	Great river	Mr. Otter		Dodge	

OK
OPTION RETURN GUIDE Portrait/Landscape Information Page Up Page Down
Timer Rec. +24 hours Search / Select

2. Select the programme, then press [OK].

3. Select “View”, then press [OK].

To change TV Guide view

Press [GUIDE] to switch between “Landscape” view and “Portrait” view.

Page up/down

Press [CH ^ V].

To view a programme list for another day

Press the green button (Previous) or the yellow button (Next).

To see programme information

Press [STATUS ].

To set a timer Recording using the TV Guide System

Refer to “Timer recording”. (⇒ 24)

To search the programmes (⇒ 25)



- Selection of channel is made easy by creating a Favourite of the channels you watch often. (? 60, Favourites Edit)

Using Channel List

You can select from the list of channel names.

1. Press [OK].

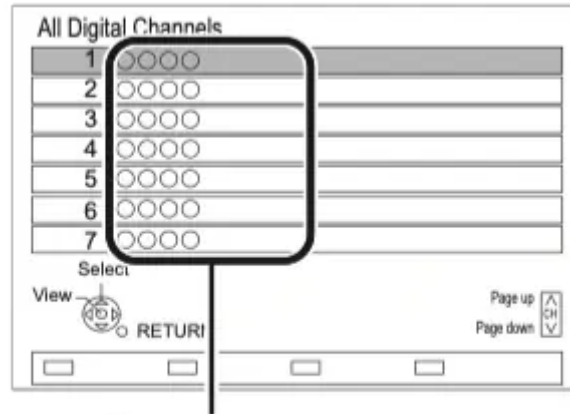

Channel names

2. Select the channel, then press [OK].

To edit the channel list

Refer to “Channel List”. (⇒ 60)

REWIND LIVE TV/PAUSE LIVE TV

This unit temporarily saves a live TV programme you are watching with this unit’s tuner on HDD.

REWIND LIVE TV

You can rewind live TV programme to the point where temporary save has started (up to 1.5 hours).

- REWIND LIVE TV does not work when watching a programme via external input.

PAUSE LIVE TV

You can pause live TV programme and restart watching from the paused position.

1. While watching TV

REWIND LIVE TV:

Press [⏮] to rewind.

PAUSE LIVE TV:

Press [⏸] to pause.

- The maximum amount of the temporary save is 1.5 hours.

2. When you want to resume:

Press [▶ x 1.3].

- You can perform search or Quick View, etc.
- If temporary save stops, playback will be performed by that point.

Display information

While pausing or rewinding a broadcast: Press [STATUS ⓘ].

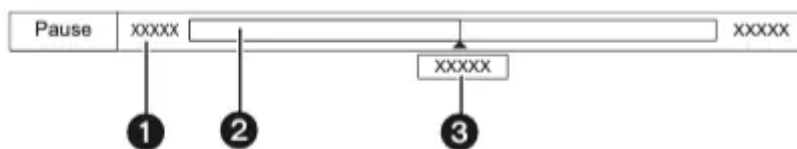

- Press [STATUS ⓘ] again.

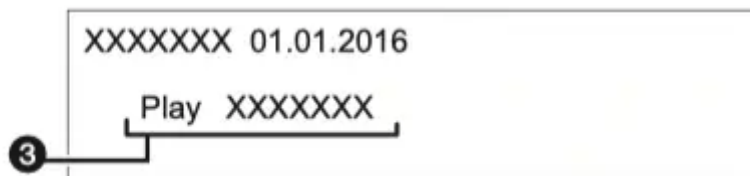

While pausing a programme via external input: Press [STATUS ⓘ] twice.

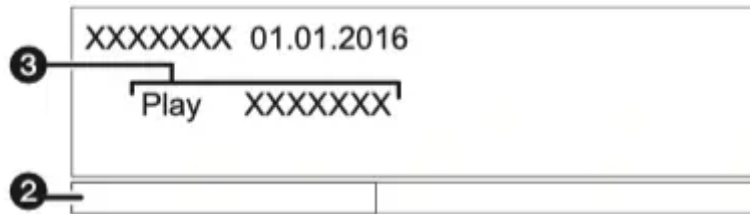

1. The time that you can rewind the live programme.
2. The amount of time temporarily saved on HDD.
3. The time of the current playback position.

To stop REWIND LIVE TV or PAUSE LIVE TV

1. Press .
2. Select "Yes", then press [OK].

To hide the display information

Press [EXIT .



- Temporary save stops in the following cases:
 - When switching to other channels or other screen
 - When the unit has started recording using all tuners
 - When performing PAUSE LIVE TV or REWIND LIVE TV for more than 8 hours (This may vary depending on the HDD free space.)
- These functions do not work in the following cases:
 - When the clock is not set
 - When all tuners are being used to record programmes
 - While copying
 - While watching a programme being recorded
 - When a radio programme is selected

Recording TV programmes



- This unit can record two programmes being broadcasted at the same time.

Preparation

If you want to change the recording mode (⇒ right)

1. Select the channel to record.
 2. Press [REC  - 3. Select “Automatic Stop”, then press [OK].
- One touch recording (OTR)

Recording stops automatically when the programme ends.

e.g., [For_Australia]

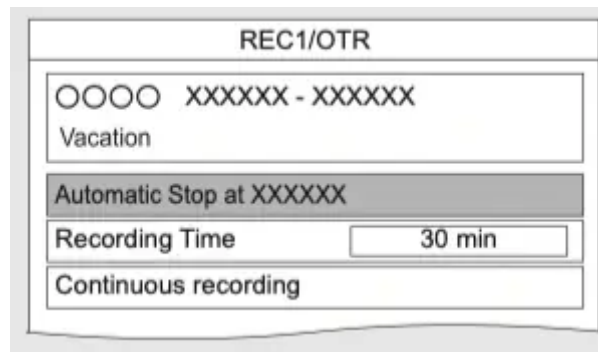

- If a timer recording reaches its start time when all tuners are being used for recording, the recording (OTR) of one of the programmes terminates.
- Teletext will not be recorded.
- Following contents or media cannot be played back while recording.
 - 3D video
 - video file
 - photo
 - USB HDD (For data files, ⇒ 16) and USB memory
- Copying cannot be performed while recording.
- When “Automatic Standby after OTR” is set to “On” (⇒ 65), this unit is turned to standby mode if this unit is not operated for approximately 5 minutes after completing “Automatic Stop” or “Recording Time”.

To set the recording time

1. Select “Recording Time” or “Continuous recording” in step 3 (⇒ above).

Recording Time:

You can set the length of recording time from 30 minutes to 4 hours.

- You can select the recording time with [◀, ▶].
2. Press [OK].

To change the recording (conversion) mode

This unit will record the programmes in DR mode once, and then automatically convert to the selected recording mode while this unit is in standby.

1. Press [OPTION].
 2. Select "Recording Mode".
 3. Select the recording mode, then press [OK].
- Recording mode (Conversion) (⇒ 16)

Recording Mode (Conversion)		
HDD Remain	<input type="radio"/> h <input type="radio"/> m (DR)	Data Size
Off (DR)		
High Definition	HG	Large ↑ ↓ Small
	HX	
	HE	
	HL	
	HM	
Standard Definition	XP	Large ↑ ↓ Small
	SP	
	LP	
	EP	

- The recording mode set here is used as an initial value for the next recording.

To convert the recording mode after recording in DR mode (⇒ 37, File Conversion)

To confirm whether the conversion is completed (⇒ 38)

To cancel a conversion (⇒ 38)



- The title before conversion (the title recorded in DR mode) will be deleted once the conversion is completed.
- Conversion will take about the same time as the recorded duration.
- When the HDD does not have enough remaining space, conversion will not start.
- Conversion is stopped when this unit is turned on. Conversion will start from the beginning again once the unit is switched to standby mode.

- When converted, audio content, subtitle and Audio Description [For_New_Zealand] will be converted with the same settings as at the start of recording.

Operation during Recording

To check the recording programme

Press [STATUS ].

e.g., While recording two programmes simultaneously

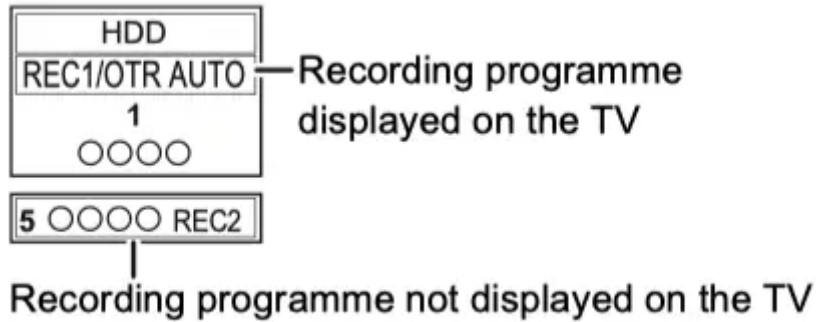

To stop recording

Press [].

When recording one programme:

If the following screen appears

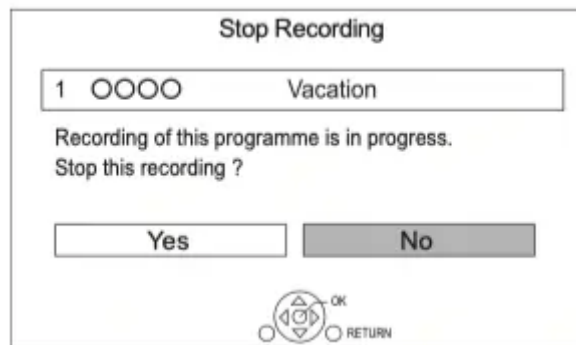

Select "Yes", then press [OK].

When recording two programmes:

Following screen appears



1. Select the programme, then press [OK].
2. Select "Yes", then press [OK].

To pause recording

After displaying the recording programme, press .

- Press again to restart recording.

(A title is not split into separate titles.)



- Timer recording programme cannot be paused.

To record two programmes simultaneously

While recording, perform steps 1–3 on page 22.







- Channel or input can only be switched between the recording programmes.

Simultaneous rec and play

You can play the recording title from the beginning or the titles previously recorded to the HDD.

1. Press [VIDEO MENU].

	Channel	Date	Title Name
	○○○○	04.10	Birds
	○○○○	04.10	World news
	○○○○	29.10	Foot ball
	○○○○	29.10	Dogs and Cats
	● ○○○		Start Time XXXXX Rec time 0:01
			Prog.Type: XXXX

 (red) is displayed on the recording programme.

2. Select the title, then press [OK].

Troubleshooting guide

Before requesting service, make the following checks. If the problem still persists, consult your dealer for instructions.

Updating to the latest software (firmware) may solve the problem. (⇒ 56)

The followings do not indicate a problem with this unit:

- Regular disc rotating sounds or HDD rotating sounds.
- Poor reception due to atmospheric conditions.
- When you switch the unit on or to standby mode, there may be an unexpected sound.

General operation

The unit does not work.

- Check the connections. (? 9)
- One of the unit's safety devices may have been activated.

Reset the unit as follows:

1. Press [⏻] on the main unit to switch the unit to standby.
 - If the unit does not switch to standby, press [⏻] on the main unit for about 3 seconds. The unit is forcibly switched to standby. Alternatively, disconnect the AC mains lead, wait one minute, then reconnect it.
2. Press [⏻] on the main unit to switch it on. If the unit still cannot be operated, consult the dealer.

Cannot eject a disc.

1. Press and hold [⏻] on the main unit for at least 3 seconds when it is turned off.
2. Press and hold [OK], the yellow button and the blue button at the same time for more than 5 seconds.
 - "00 RET" is displayed on the front panel display.
3. Repeatedly press [▶] (right) until "06 FTO" is displayed on the front panel display.
4. Press [OK].

The remote control does not work.

- The remote control and main unit are using different codes. Change the code on the remote control.

"Remote Control " appears on the right side of the screen.

("□" stands for a number.)

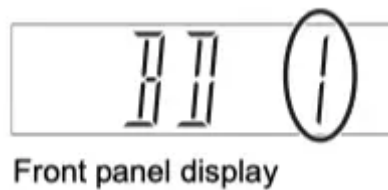

Press and hold [OK] and the indicated number button at the same time for more than 5 seconds.
(⇒ 66)

Startup is slow.

Press and hold [OK] and the indicated number button at the same time for more than 5 seconds.
(⇒ 66)

- Startup takes time in the following situations:
 - A disc is inserted.
 - The clock is not set.
 - Immediately after a power failure or the AC mains lead is connected.
 - When a BD-J application is executing.
 - When the "Quick Start" is not activated. (? 65)

Displays

"0:00" is flashing on the front panel display.

- Set the clock. (⇒ 66)

The clock does not display on the unit when switched to standby.

- The clock does not display when "Quick Start" is not activated. (⇒ 65)

TV screen and video

Screen size is wrong.

- Check the "TV Aspect" or "Aspect for 4:3 Video". (⇒ 64)
- Adjust the aspect ratio setting on TV.
- Adjust the aspect ratio setting on this unit. (⇒ 59)
- Check "Aspect for Recording" before recording or file conversion. (⇒ 62)

The black screen appears on the TV.

- This phenomenon may occur, depending on the TV setting, when “Quick Start” is activated. Depending on the TV, this phenomenon may be prevented by reconnecting to a different HDMI input terminal.

TV reception is not displayed.

- Broadcast signals are not output from this unit’s RF OUT terminal. Select “On” in “RF OUT (Aerial Signal)”. (⇒ 66)

The screen changes automatically.

- If “Screen Saver” set to “On”, the screen saver function will be activated when there is no operation for 5 minutes or more. (⇒ 64)

There is a lot of image lag when playing video.

- Set to “0” all items in the “Noise Reduction”. (⇒ 35)
- Set “Audio Delay”. (⇒ 64)

The images do not appear on the TV. The picture is distorted during play, or video is not played correctly.

- Check the connections. (⇒ 9)
- Check the settings of the connected TV, etc.
- An incorrect resolution is selected in “HDMI Video Format”. (⇒ 64) Reset the setting as follows:

1. While the unit is on, press and hold [OK], the yellow button and the blue button at the same time for more than 5 seconds.

- “00 RET” is displayed on the front panel display.

2. Repeatedly press [▶] (right) until “04 PRG” is displayed on the front panel display.

3. Press and hold [OK] for at least 3 seconds. Set the item again.

- When Dolby Digital Plus, Dolby TrueHD, and DTS-HD ® audio are not output properly, select “Yes” in “Default Settings” and make proper settings. (⇒ 66)
- The unit’s TV System is different from that of the disc. Change the TV System. (⇒ 64, TV System)
- The picture may be distorted or a black screen may appear between scenes recorded with different aspect ratios.
- Set “Deep Colour Output” (⇒ 65) or “Contents Type Flag” (⇒ 65) to “Off”.
- The country setting is not set correctly. Perform “Shipping Condition” (⇒ 66) first, and then set the country you live in again.

3D video is not output correctly.

- 3D video may be output correctly by changing the following settings:
 - “3D Type” of “3D Settings” (⇒ 64)
 - “Signal Format” (⇒ 34, 3D settings during playback)
- Check the settings of the connected TV.
- When a non-3D compatible amplifier/receiver is connected between this unit and a TV, 3D video is not output. (⇒ 10)
- When “HDMI Audio Output” is set to “Off”, 3D video may not be output correctly. (⇒ 65)

Sound

No sound. Distorted sound.

- Check the connections. (⇒ 9)
- Check the settings of the connected TV, etc.
- Press [AUDIO] to select the audio. (⇒ 20, 33)
- To output audio from a device connected with an HDMI cable, set “HDMI Audio Output” to “On”. (⇒ 65)

Cannot change audio channel.

- You cannot change the audio channel if “Digital Audio Output” is set to “Bitstream”. (⇒ 63)

Recording, timer recording and copying

Cannot record. Cannot copy.

- Some broadcasts are copyright protected.
- You cannot record to the disc by pressing the [REC - The disc is protected. (⇒ 57)
- [DVD-R] [DVD-RW] [+R] [+RW] Since it will copy to HDD temporarily, copying is not possible if there is insufficient available capacity on the HDD.
- This unit cannot record/copy NTSC signals to discs that already have PAL signal recordings.

Timer recording does not work properly.

- When  is displayed on the screen. (⇒ 27)

Auto Renewal Recording does not work properly.

- The programme will not be overwritten in the following cases:

- the programme is protected
- any programme is being played back or copied
- a screen such as Video Menu is displayed Instead, the programme will be saved as a separate programme and that will be overwritten.

A part or whole of a recorded title has been lost.

- If there is a power failure or the AC mains lead is disconnected from the household mains socket while recording or editing, the title may be lost or the HDD may become unusable. We cannot offer any guarantee regarding lost programmes.

An unusually loud sound is coming from the rotating disc.

- If you want copy to perform more quietly, select “Normal (Silent)” in “Disc Speed for High Speed Copy”. (⇒62)

The time recorded on the disc and the available time shown do not add up.

- [DVD-R] [+R] If you record or edit many times, the remaining capacity is reduced and then recording or editing may be disabled.
- Available disc space display may be different from actual.

Play

Cannot play back.

Photos do not play back normally.

- The disc is dirty. (⇒17)
- The disc is scratched or marked.
- The disc may not be able to play back if it was not finalised or a Top Menu was not created on the equipment used for recording.
- Refer to “Screen icons”. (⇒29)

Audio and video momentarily pause.

- DVD-R DL and +R DL discs have two writable layers on one side. Video and audio may momentarily cut out when the unit is switching layers.

You have forgotten your rating PIN.

- The rating level returns to the factory preset.

1. While the unit is on, press and hold [OK], the yellow button and the blue button at the same time for more than 5 seconds.

- “00 RET” is displayed on the front panel display.

2. Repeatedly press [▶] (right) until “03 VL” is displayed on the front panel display.

3. Press [OK].

- "INIT" is displayed on the front panel display.

Image for the Quick View is not smooth.

- Image may not be played back smoothly in case of high definition titles.

Cannot play the disc on other players.

- Refer to "Play on other players". (⇒ 17)

Edit

Cannot edit.

- You may not be able to edit on the HDD if there is no available space. Delete any unwanted titles to create empty space. (⇒ 36)

Photo

Photos do not play back normally.

- The images that were edited on the PC, such as Progressive JPEG, etc., may not play back (⇒ 15)

USB

This unit does not recognize the USB device correctly.

- If inserted during playback the USB device may not be recognized by this unit. Disconnect and reconnect the USB device. If it still does not recognize the connection, switch the unit to standby mode and turn it on again.
- USB devices connected using a USB extension cable other than a dedicated one or a USB hub may not be recognized by this unit.

TV Guide

The TV Guide information is not displayed properly.

- Set the clock correctly. (? 66, Clock)
- There was a programme change, or TV Guide information from a broadcast station was possibly not correctly transmitted.
- If signal quality is bad, the TV Guide system may not be able to receive any data.
- It may take time until the TV Guide screen is displayed correctly. Wait for about a day.

Broadcast

Picture regularly breaks up on some channels.

- Adjust the reception with “Manual Tuning”. (⇒ 60)

Reset

To return all the settings to the factory preset

Perform “Shipping Condition” or “Default Settings”. (⇒ 66)

Messages on the front panel display

The following messages or service numbers appear on the front panel display when something unusual is detected.

BD

(“ ” stands for a number.)

The remote control and main unit are using different codes. Change the code on the remote control. (⇒ 67)

CONV

Selected titles in the USB HDD are being converted. Do not disconnect the USB HDD from this unit.

GUIDE

TV Guide data is being downloaded.

NoERAS

You cannot delete items on this disc. The disc may be damaged.

NoREAD

- The disc is dirty. (⇒ 17) The unit cannot read the disc.
- The lens cleaner has finished cleaning.

Press [ OPEN/CLOSE] on the main unit to eject the disc.

NoWRIT

You cannot write to this disc. The disc may be damaged. Use a new disc.

PLEASE WAIT

- Displayed when the unit is started and is switched to standby mode.
- There was a power failure or the AC plug was disconnected while the unit was on. The unit is carrying out its recovery process. Wait until the message disappears.

PROG FULL

There are already 32 timer programmes. Delete unnecessary timer programmes. (⇒ 27)

REMOVE

The USB device is drawing too much power. Remove the USB device.

START

Update of the software (firmware) is started. You cannot operate the unit until the update is complete. (⇒ 56)

SW-DL

Software (firmware) is downloading.

Download will stop when the unit is turned on, or the timer recording starts. (? 56) When "FINISH" is displayed, update of the software (firmware) has completed.

UNSUPPORT

The media is not supported.

UPD / (" " stands for a number.)

The software (firmware) is being updated. You cannot operate the unit until the update is complete. (? 56)

U50

An error has occurred in the antenna's power supply. Check to see if the antenna's cable core and braided wire shield are in contact with each other.

U59

The unit is hot. The unit switches to standby for safety reasons. Wait for about 30 minutes until the message disappears.

Install or place this unit with good ventilation.

U61

(When a disc is not inserted) A malfunction has occurred. The unit is trying to restore to the normal operation. Once the message disappears you can use the unit again. If it remains displayed, consult the dealer.

U76

HDMI cannot be output because it is connected to a model that does not support copyright protection.

U77

Due to the current disc not having authorised copyright information, video output is not performed.

U88

(When a disc is inserted) There was something unusual detected with the disc or the unit. The unit is trying to restore to the normal operation. Once the message disappears you can use the unit again. If it remains displayed, consult the dealer.

U99

The unit fails to operate properly. Press [I/I] on the main unit to switch the unit to standby mode. Now press [I/I] on the main unit again to turn the unit on.

X HOLD

The HOLD function is activated. (→59)

Warning

This content is compiled from multiple sources and is provided for reference purposes only. It may not be complete or fully applicable to all situations. If you are unable to resolve your issue, please contact the product manufacturer or an authorized service provider for official support.