

USING THE DRYER

Getting started

WARNING To reduce the risk of fire, electric shock, or injury to persons, read the IMPORTANT SAFETY WARNING INFORMATION before operating this appliance.

WARNING - Fire Hazard

- Keep flammable materials and vapors, such as gasoline, away from dryer.
- DO NOT dry anything that has ever had anything flammable on it (even after washing).
- No washer can completely remove oil.
- DO NOT dry anything that has ever had any type of oil on it (including cooking oils).
- Items containing foam, rubber, or plastic must be dried on a clothesline.
- Follow all fabric care instructions and warnings to prevent melting of garments or damage to the appliance.
- Failure to do so can result in death, explosion, or fire.

Throughout this manual, features and appearance may vary from your model.

Step 1



- Loosely add items.
- Close door.

NOTE: Dryer will not start with door open.

Step 2



- If the screen is dark, press the Power button to “wake up” the display.

Step 3

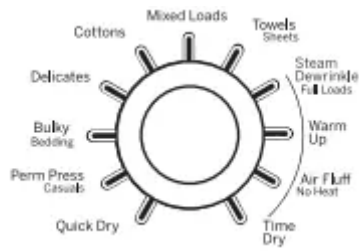

- Select a dry cycle. (Defaults are set for each dry cycle. These default settings can be changed. See the cycle descriptions for more information.)

Step 4

Start/Pause



- Press the Start/ Pause button.

Model: GFD45– Steam Dryer with HE SensorDry™

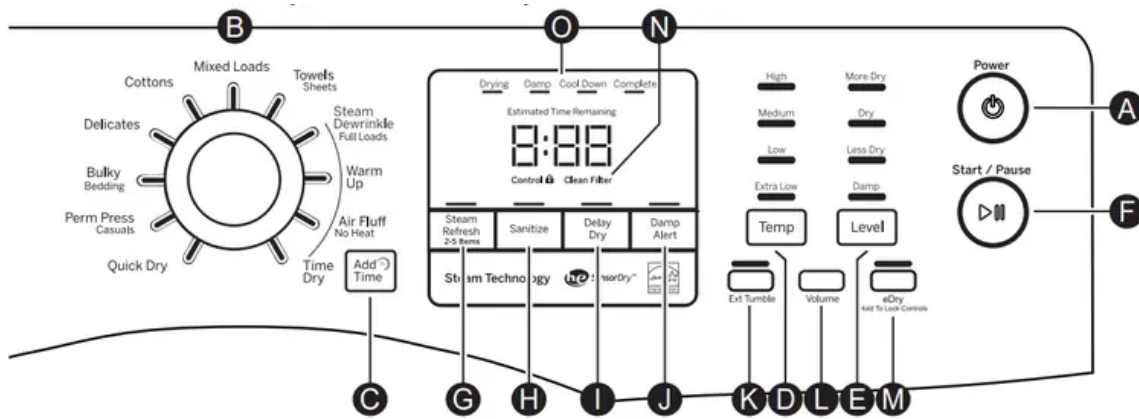

A**Power**



Press to “wake up” the display. If the display is active, press to turn the dryer off.

NOTE: Pressing Power does not disconnect the appliance from the power supply

B**Dry Cycles**

The dry cycle controls the cycle time for the drying process. The chart below will help you match the dry setting with the loads.

Mixed Loads	For loads consisting of cottons and poly-blends
Cottons	For cottons and most linens. NOTE: Energy Star® models are tested on Cottons with default settings.
Delicates	For lingerie and special-care fabrics.
Bulky/Bedding or Bulky Items	For large coats, bed spreads, mattress covers, sleeping bags, blankets, comforters, jackets, small rugs, and similar large and bulky items.
Perm Press/ Casuals	Clothing worn for active sports exercise and some casual wear. Fabrics include new technology finishes and stretch fibers such as Spandex. Also for clothing labeled Easy Care or Perma Press: For wrinkle-free and permanent press items.
Quick Dry	For small loads that are needed in a hurry, such as sports or school uniforms. Can also be used if the previous cycle left some items damp, such as collars or waistbands.
Towels/Sheets	Use for towels OR sheets. It is not recommended to mix towels and sheets in the same load.
Steam Dewrinkle Full Loads (on some models)	Provides 20 minutes of steam drying to assist with dewrinkling clothes. Ideal for loads left in dryer for an extended time.
Dewrinkle Full Loads (on some models)	Provides 20 minutes of drying to assist with dewrinkling items that are dry or slightly damp. This cycle is not recommended for delicate fabrics.

Warm Up	Provides 10 minutes of warming time to warm up clothes.								
Air Fluff/No Heat	Provides 10 minutes of tumbling time without heat.								
Time Dry	<p>Use to set your own dry time. Time Dry is also recommended for small loads. To use:</p> <ol style="list-style-type: none"> 1. Turn dry cycle dial to Time Dry. 2. Increase the drying time by pressing the Add Time button. <p>NOTE: This button only increases the time. When max time is reached, pressing the button again will reset the counter to the lowest setting.</p> <ol style="list-style-type: none"> 3. Select the Temp. 4. Close the door. 5. Press Start/Pause. 								
	<p>Add Time</p> <p>Press to add time to the Steam Dewrinkle, Dewrinkle, Warm Up, Air Fluff or Time Dry cycles in 10 minute increments.</p>								
	<p>Temp (Temperature)</p> <p>You can change the temperature of your dry cycle.</p> <table border="1" data-bbox="437 1299 1409 1615"> <tr> <td>High</td> <td>For regular to heavy cottons.</td> </tr> <tr> <td>Medium</td> <td>For synthetics, blends and items labeled Permanent Press.</td> </tr> <tr> <td>Low</td> <td>For delicates, synthetics and items labeled Tumble Dry Low.</td> </tr> <tr> <td>Extra Low</td> <td>For lingerie and special-care fabrics.</td> </tr> </table>	High	For regular to heavy cottons.	Medium	For synthetics, blends and items labeled Permanent Press.	Low	For delicates, synthetics and items labeled Tumble Dry Low.	Extra Low	For lingerie and special-care fabrics.
High	For regular to heavy cottons.								
Medium	For synthetics, blends and items labeled Permanent Press.								
Low	For delicates, synthetics and items labeled Tumble Dry Low.								
Extra Low	For lingerie and special-care fabrics.								
	<p>Level</p> <p>The sensor continuously monitors the amount of moisture in the load. When the moisture in your clothes reaches your selected dry level, the dryer will stop.</p> <p>NOTE: Sensor dry Level only works with Cottons, Normal, Perm Press, Delicates, Quick Dry, Bulky, Towels/Sheets, Dewrinkle and Steam Dewrinkle cycles.</p>								

More Dry	Use for heavy-duty fabrics or items that should be very dry, such as towels
Dry	Use for normal dryness level suitable for most loads. This is the preferred cycle for energy saving.
Less Dry	Use for lighter fabric (ideal for ironing).
Damp	For leaving items partially damp.



Start/Pause

Press to start a dry cycle. If the dryer is running, press it once and it will pause the dryer. Press it again to resume the dry cycle.

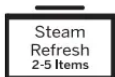

Steam Refresh Cycle (on some models)

For slightly wrinkled dry garments. Significantly reduces wrinkles on up to 5 garments. After the Steam Refresh Cycle, the unit will beep and display “0:00.” If the unit is not turned off or if the door is not opened, the dryer will continue to tumble for 30 minutes. At the end of 30 minutes, it will display “0:00” and the cycle will be complete.

NOTE: A single extremely light fabric item may need to have an additional item included to achieve optimum results.

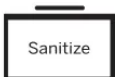

Sanitize

This option reduces certain types of bacteria by 99.8%, including: Staphylococcus aureus, Pseudomonas aeruginosa and Klebsiella pneumoniae. The anti-bacterial process occurs when high heat is used during a portion of the drying cycle.





NOTE: Do not use this cycle on delicate fabrics.



Delay Dry

Use to delay the start of your dryer.

1. Choose your dry cycle and any options.
2. Press Delay Dry. You can change the delay time in 1 hour increments, using the Delay Dry button.
3. Press the Start/Pause button to start the countdown.

	<p>NOTE: If the door is opened while the dryer is in Delay Dry, the countdown time will not restart unless the door is closed and Start/Pause button has been pressed again.</p>
<p>J</p> 	<p>Damp Alert</p> <p>This option causes the dryer to beep when clothes have dried to a damp level. Remove items that you wish to hang dry. The Damp Alert will only beep when this option is selected, and the dryer will continue to dry. Removing clothes and hanging them when they are damp can reduce the need to iron some items.</p>
<p>K</p> 	<p>Ext Tumble</p> <p>Minimizes wrinkles by adding approximately 1 hour of no-heat tumbling after clothes are dry.</p> <p>The estimated time remaining display will show “END”.</p> <p>The extended tumble time does not get added to the cycle time on the display.</p>
<p>L</p> 	<p>Volume</p> <p>Alerts you that the cycle is complete. The beeper will continue to sound every minute for the next 5 minutes, until the clothes have been removed. The clothes should be removed when the beeper goes off so wrinkles don't set in.</p> <p>Press Volume to select low, medium or high volume, or to turn the beeper off.</p> <p>To turn on or off the sounds the buttons make when pressed, press and hold the Volume button for 3 seconds.</p>
<p>M</p> 	<p>eDry</p> <p>Reduces the total energy consumption of specific dryer cycles by adjusting certain heat settings.</p> <p>NOTE: Cycle times will change when e-Dry is selected. The eDry option will default to on for Cottons. For optimal energy savings, turn eDry on. For optimal drying times, turn eDry off. Energy savings will vary across loads and cycles.</p> <p>This cycle can be used with Cottons, Mixed Loads, Towels/Sheets, Delicates, Bulky Bedding, Perm Press/Casuals and Quick Dry. When the eDry button is pressed, cycle settings change to reduce the total energy consumption of the selected sensor cycle.</p> <p>Lock Controls</p>

You can lock the controls to prevent any selections from being made. Or you can lock or unlock the controls after you have started a cycle.

Children cannot accidentally start the dryer by touching buttons with this option selected.

To lock/unlock the dryer controls, press and hold the eDry button for 3 seconds. A sound is made to indicate the lock/unlock status. The indicator light above the button will illuminate when the controls are locked.

NOTE: The Power button can still be used when the machine is locked.

N Clean Filter

Clean Filter Message

This message represents only a reminder and does not always appear when the filter needs cleaning. The filter should be cleaned after every drying cycle is complete.

This message will disappear after the Start/Pause button is pressed. Even though you may have already cleaned the filter (before or after the Power button has been pressed), the "Clean Filter" message will still be displayed until the Start/Pause button is activated.

O



Display

Displays the approximate time remaining until the end of the cycle.

As the cycle begins, you will see an initial approximate total cycle time in the display.

Then lights will "race" in the display. This means the dryer is continuously monitoring the amount of moisture in the load. The lights will continue until the dryer senses a low level of moisture in the load. At that point, the dryer will calculate and display the approximate time remaining.

P



My Cycle (on some models)

Set up your favorite combination of settings and save them here for one touch recall.

These custom settings can be set while a cycle is in progress.

To store a My Cycle combination of settings:

1. Select your drying cycle.
2. Change Temp and Level settings to fit your needs.
3. Select any drying options you want.

4. Press and hold the My Cycle button for 3 seconds to store your selection. A beep will sound and the button will light up.

To recall your stored My Cycle combination:

Press the My Cycle button before drying a load.

To change your stored My Cycle combination: Repeat steps 1–4.

Loading

Always follow fabric manufacturer's care label when laundering.

Sorting and Loading Hints

WARNING - Fire Hazard

- Keep flammable materials and vapors, such as gasoline, away from dryer.
- DO NOT dry anything that has ever had anything flammable on it (even after washing).
- No washer can completely remove oil.
- DO NOT dry anything that has ever had any type of oil on it (including cooking oils).
- Items containing foam, rubber, or plastic must be dried on a clothesline.
- Failure to do so can result in death, explosion, or fire.

As a general rule, if clothes are sorted properly for the washer, they are sorted properly for the dryer. Try also to sort items according to size. For example, do not dry a sheet with socks or other small items.

Do not add fabric softener sheets once the load has become warm. They may cause fabric softener stains. Bounce® Fabric Conditioner Dryer Sheets have been approved for use in this dryer when used in accordance with the manufacturer's instructions.

Do not overload. This wastes energy and causes wrinkling.

CARE AND CLEANING

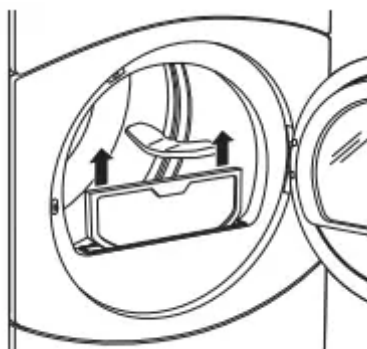

The Lint Filter: Clean the lint filter before each use.

Pull out the lint filter. Moisten your fingers and remove the captured lint. Once clean, slide the filter back into position. Have a qualified technician vacuum the lint from the dryer once a year.

NEVER OPERATE THE DRYER WITHOUT ITS FILTER IN PLACE.

Stainless Steel: To clean stainless steel surfaces use a damp cloth with a mild, nonabrasive cleaner suitable for stainless steel surfaces. Remove the cleaner residue and then dry with a clean cloth.

The stainless steel used to make the dryer drum provides the highest reliability available in a GE Appliances dryer. If the dryer drum should be scratched or dented during normal use, the drum will not rust or corrode. These surface blemishes will not affect the function or durability of the drum.

The Exterior: Wipe or dust any spills or washing compounds with a damp cloth. Dryer control panel and finishes may be damaged by some laundry pretreatment soil and stain remover products. Apply these products away from the dryer. The fabric may then be washed and dried normally. Damage to your dryer caused by these products is not covered by your warranty.

Dryer Interior and Duct: The interior of the appliance and exhaust duct should be cleaned once a year by qualified service personnel.

The Exhaust Duct: Inspect and clean the exhaust ducting at least once a year to prevent clogging. A partially clogged exhaust can lengthen the drying time.

The Exhaust Hood: Check with a mirror that the inside flaps of the hood move freely when operating. Make sure that there is no wildlife birds, insects, etc.) nesting inside the duct or hood.

Drum Lamp

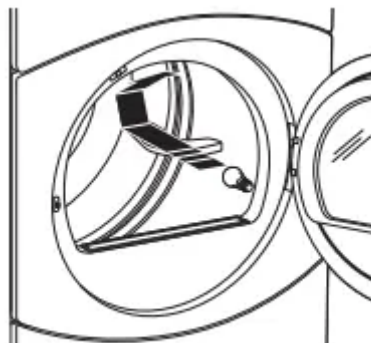

The drum lamp comes on automatically when the door is opened.

Before replacing the light bulb, be sure to unplug the dryer power cord or disconnect the dryer at the household distribution panel by removing the fuse or switching off the circuit breaker. Reach above dryer opening from inside the drum. Remove the bulb and replace with the same size bulb.

Order replacement bulb WE4M305 on-line at [GEApplianceParts](http://GEApplianceParts.com), by phone at 877.959.8688 during normal business hours, or purchase appliance bulb 7C7 from your local retailer.

VENTING

Venting the Dryer

For the best drying performance, the dryer needs to be properly vented. The dryer will use more energy and run longer if it is not vented to the specifications below. Carefully follow the details on Exhausting in the Installation Instructions.

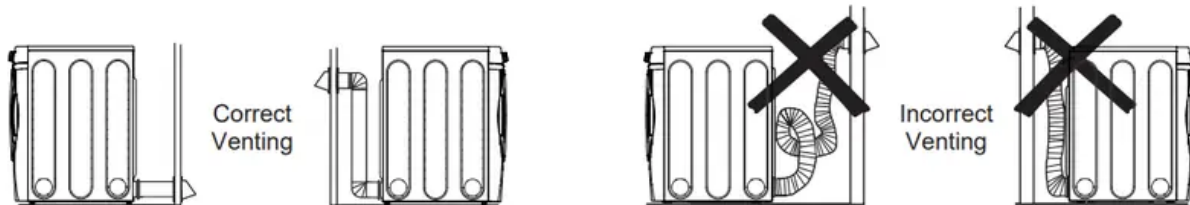

WARNING - Fire Hazard

This dryer **MUST** be exhausted to the outdoors.

Use only 4" rigid metal ducting for the home exhaust duct.

Use only 4" rigid metal or UL-listed dryer transition duct to connect the dryer to the home exhaust.

DO NOT use a plastic vent.

DO NOT exhaust into a chimney, kitchen exhaust, gas vent, wall, ceiling, attic, crawl space, or concealed space of a building.

DO NOT install a screen in or over the exhaust duct.

DO NOT install a booster fan in the exhaust duct.

DO NOT use duct longer than specified in the exhaust length table.

Failure to follow these instructions can result in death or fire.

Optional Instructions

REVERSING THE DOOR SWING (if desired)

1. REMOVE THE DOOR ASSEMBLY

A. Open the door to approximately 130 degrees.

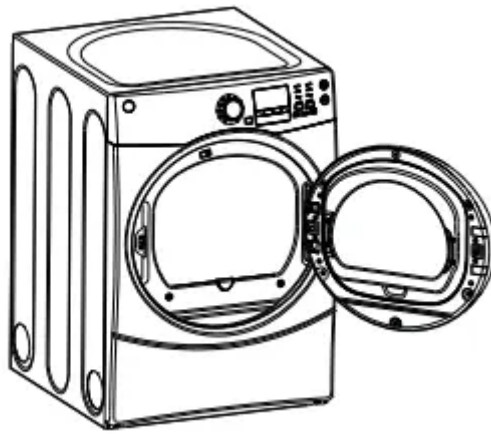

B. Remove the 6 tapping screws located around the perimeter of the door outlining the gasket. Remove the outer ring.

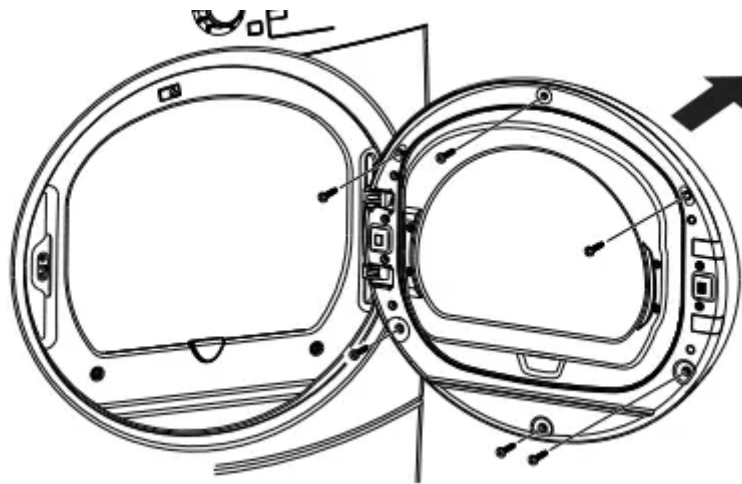

C. Remove 3 hinge screws starting at the bottom and move up. Make sure the door is supported while removing the screws.

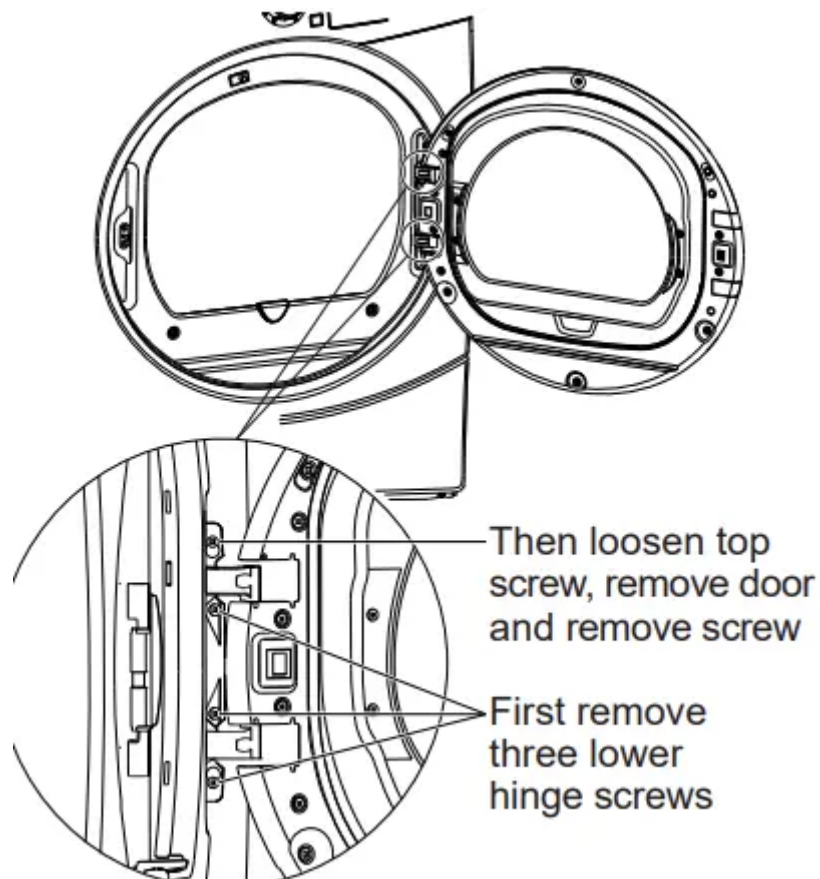

D. Loosen the top screw as shown. Unhook the door by lifting and pulling. Remove the top screw.

2. REMOVE HINGE AND COVER

IMPORTANT: Note the location of the hinge (left or right) before removing.

A. Remove the 6 machine screws from the hinge and the 2 machine screws from the hinge cover.

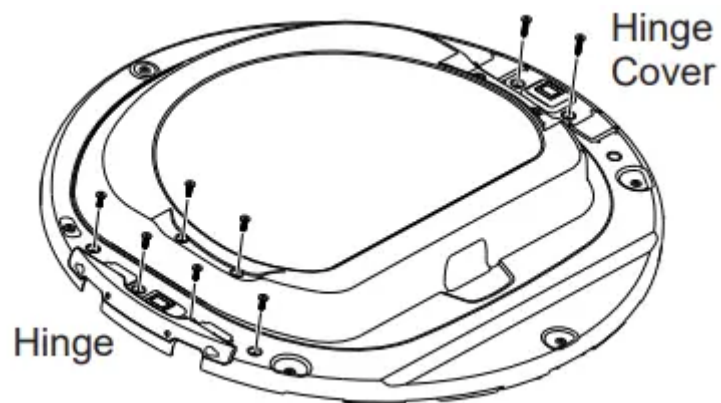

B. With the screws removed, turn the door over and separate the outer door assembly and hinge cover of the door from the door frame and set aside.

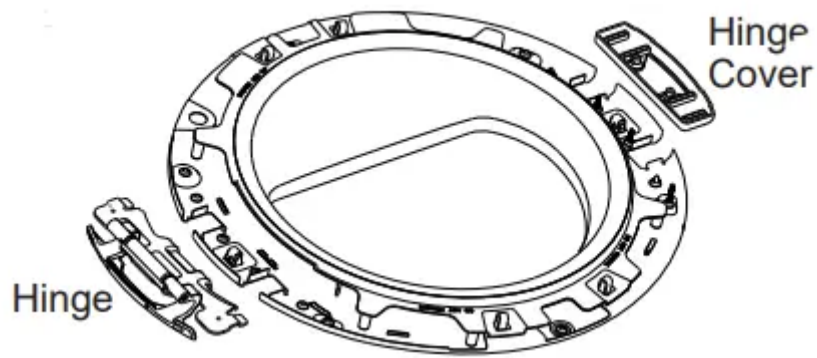

3. REINSTALL HINGE ASSEMBLY

A. Place the hinge in the opposite side of the door as shown. Push the hinge in place until the hinge holes align with the door holes.

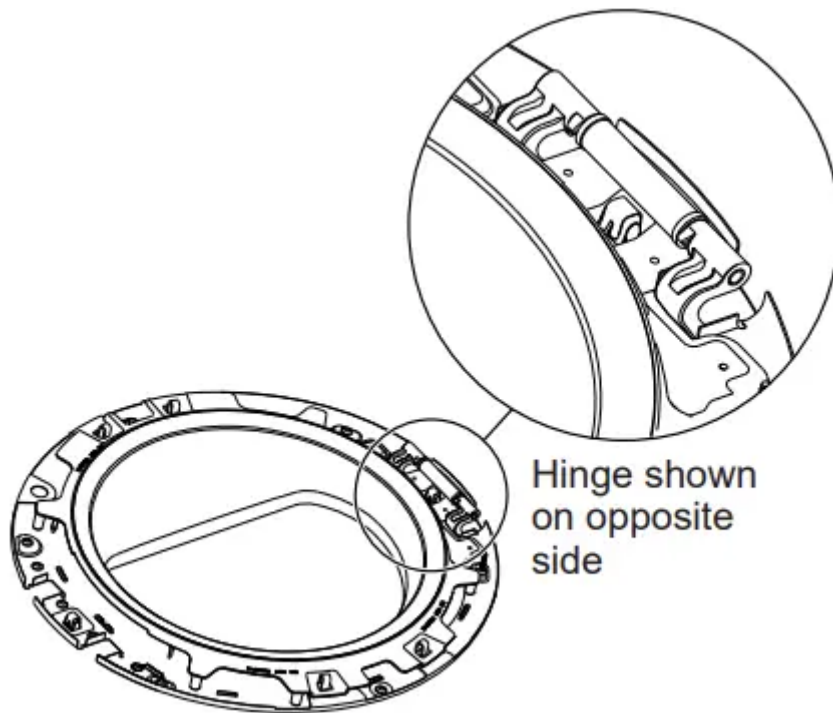

B. Hold the hinge in place and turn the door over. Install the hinge using the 6 machine screws removed earlier.

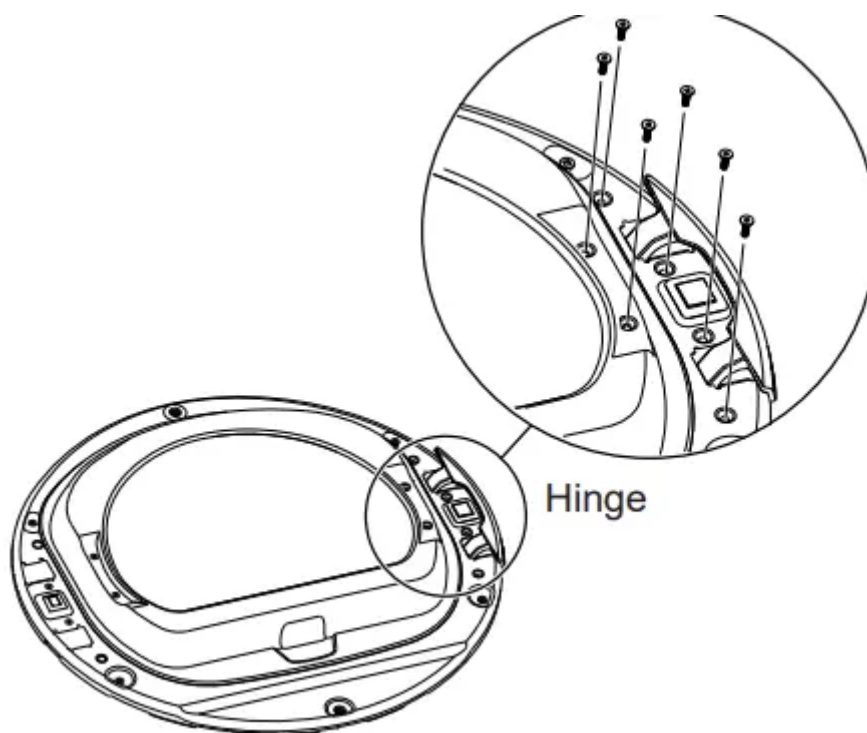

4. REINSTALL HINGE COVER

A. Turn the door over and place the hinge cover in the opposite side of the door as shown. Align the hinge cover holes with the holes in the door.

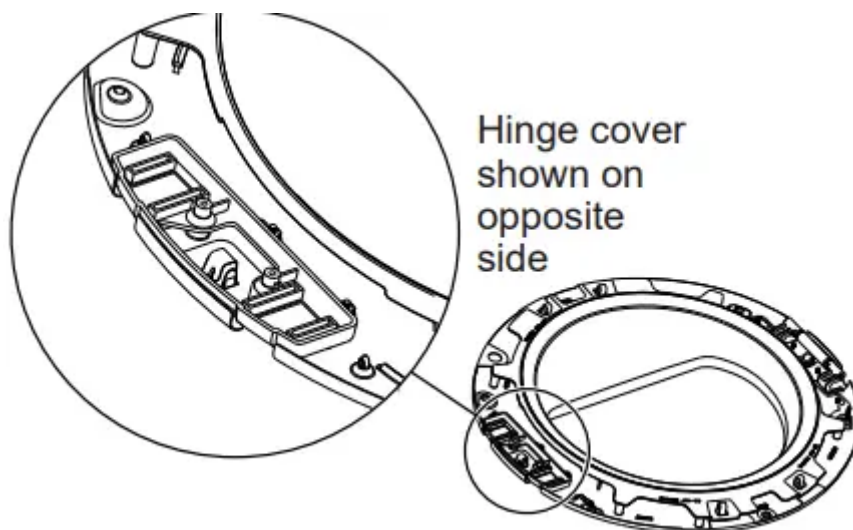

B. Hold the hinge cover in place and turn the door over. Install the hinge cover using the 2 machine screws removed earlier.

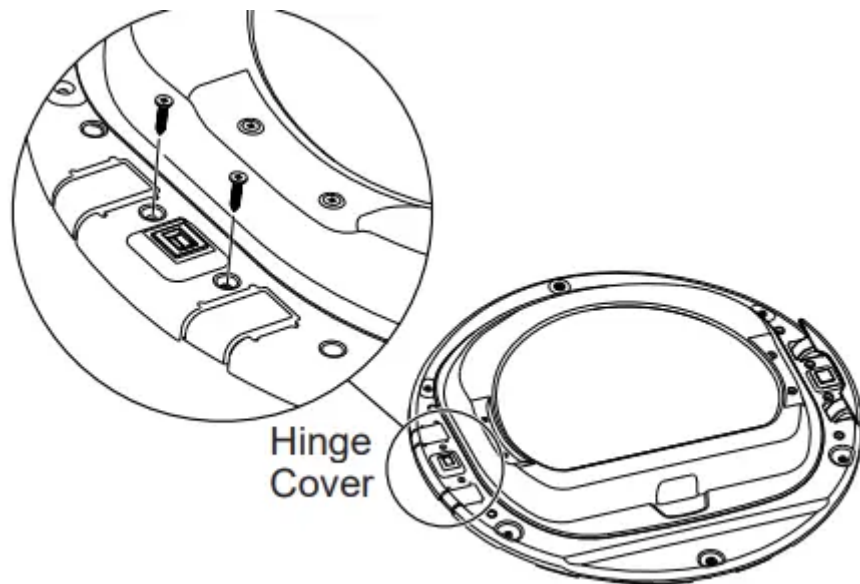

5. MOVE STRIKE BRACKET

A. Using a putty knife or any other flat tool, remove the 4 beauty buttons located on the dryer where the door will be installed and install them on the opposite side.

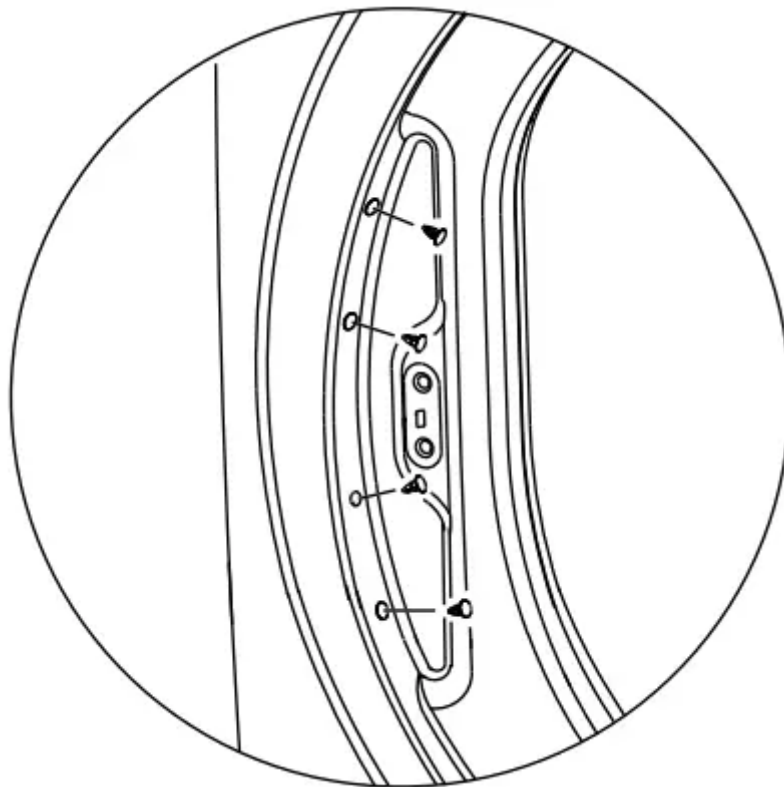

B. Switch the strike bracket and its cover to the opposite side by removing the screws. Reinstall both on the opposite side.

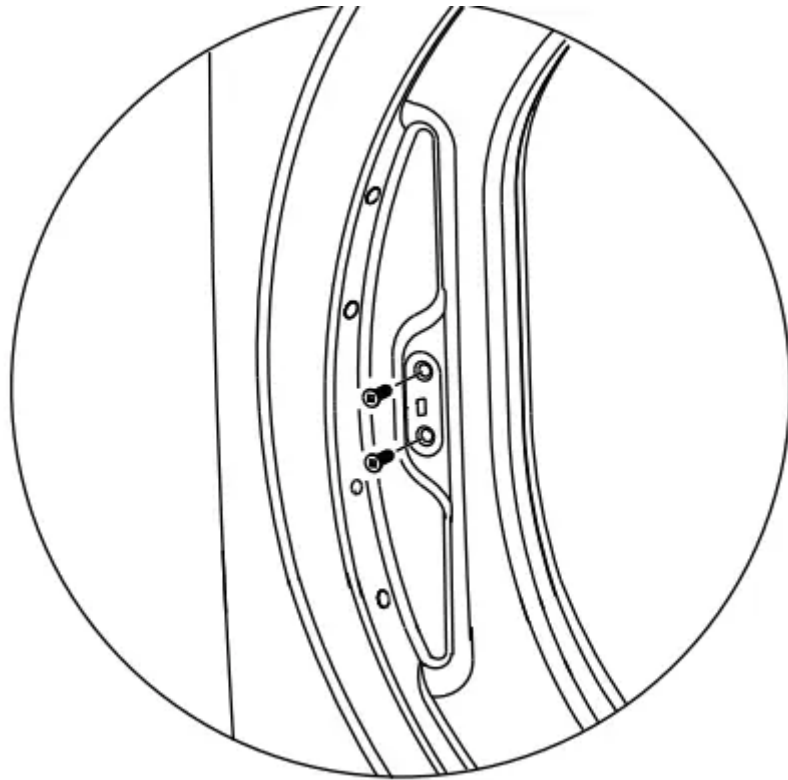

6. REINSTALL DOOR ASSEMBLY

A. Install the door on the dryer. To ease this step, the hinge has keyholes that allow a partially fastened screw to be used as a hook.

Partially fasten a screw to the uppermost screw hole. Hook the door on the partially fastened screw. Fasten the hinge by installing the other 3 screws and tightening the partially fastened screw above.

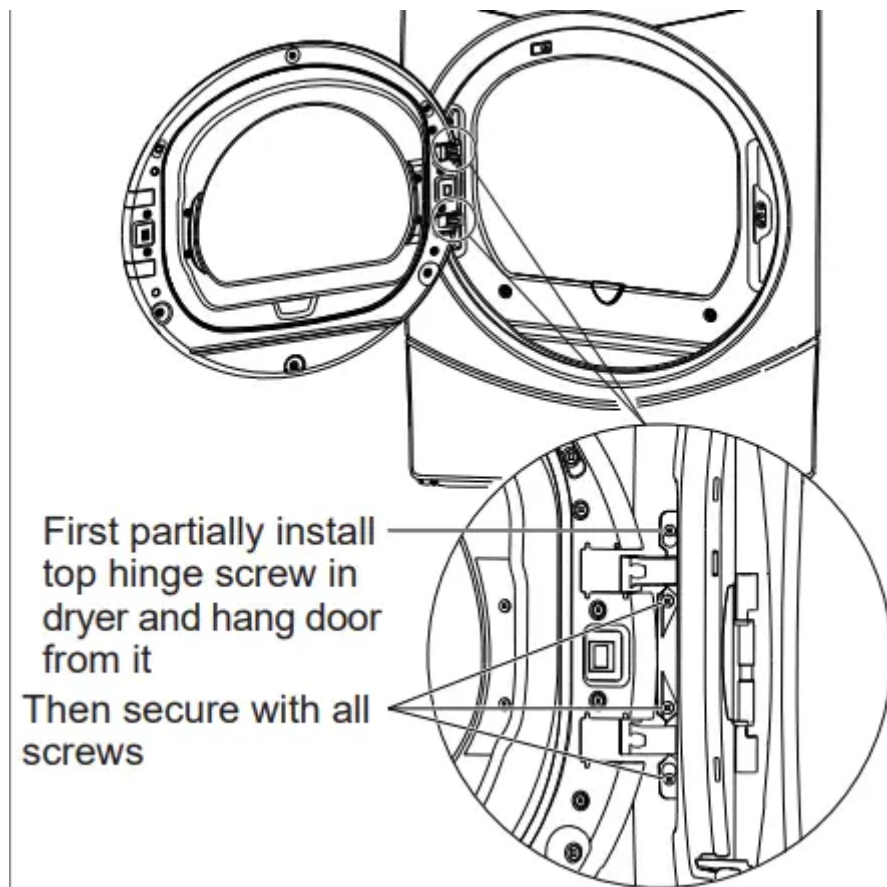

B. Align the outer ring in the door and fasten the 6 tapping screws located around the perimeter of the door outlining the gasket.

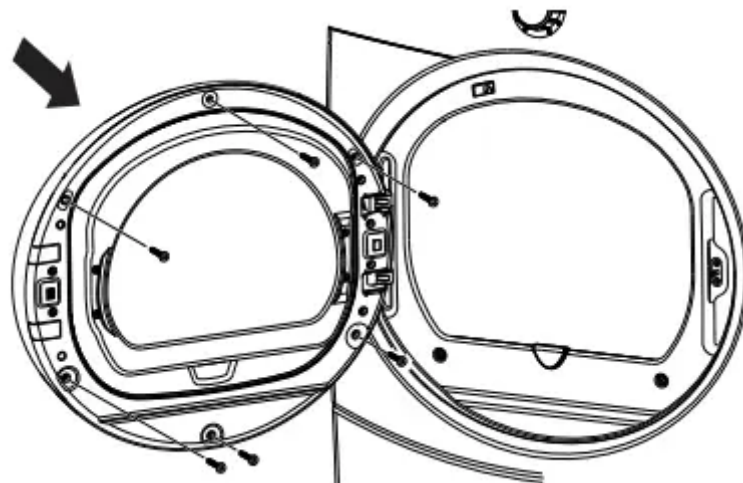

INSTALLING THE STACK BRACKET KIT

1. REMOVE THE DRYER LEVELING LEGS

A. Carefully lay the dryer on its side. Use the packing material so you don't scratch the finish on the dryer.

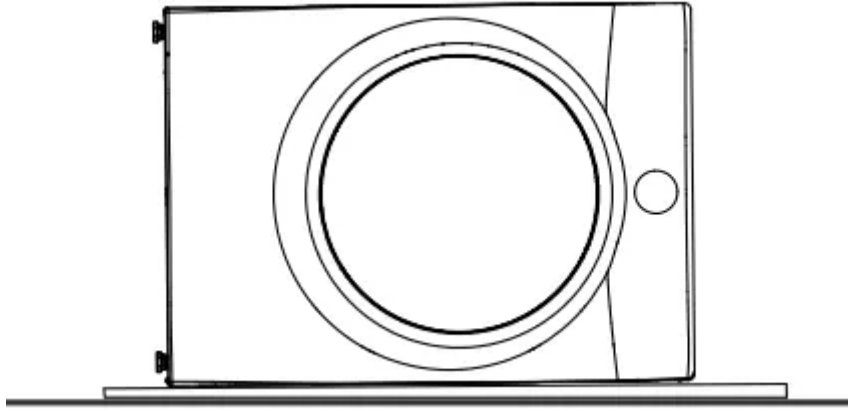

B. Use an open-end wrench or pliers to remove the dryer leveling legs.

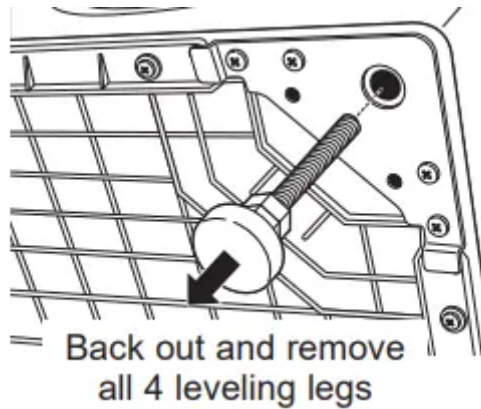

2. INSTALL RUBBER PADS TO DRYER BASE

Locate the 4 rubber pads in the parts package. Remove the adhesive backing and firmly place over each bracket where you removed the leveling legs.

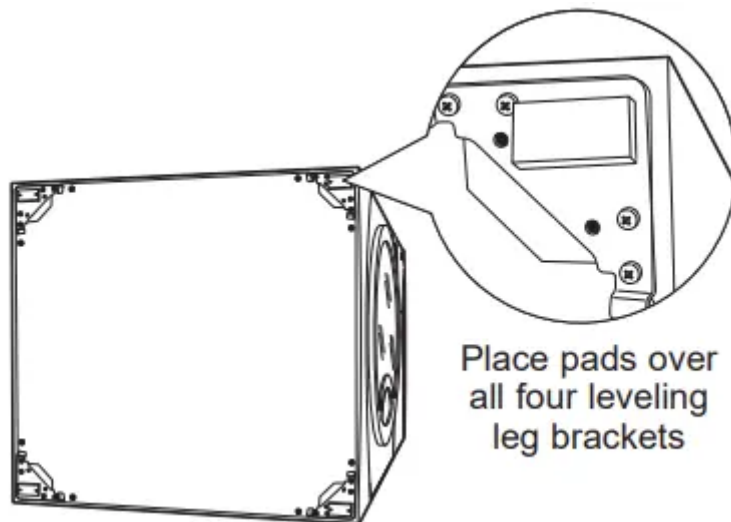

3. INSTALL BRACKET TO DRYER

A. Align the holes in the left bracket with the holes in the bottom left corner of the dryer. Use a Phillips screwdriver to install the 2 #12 x 1" tapping screws.

B. Repeat the above step with the right bracket on the bottom right corner of the dryer.

C. Set the dryer upright.

NOTE: Make sure to set the dryer on a piece of packing material so the brackets that are attached to the bottom of the dryer do not damage the floor.

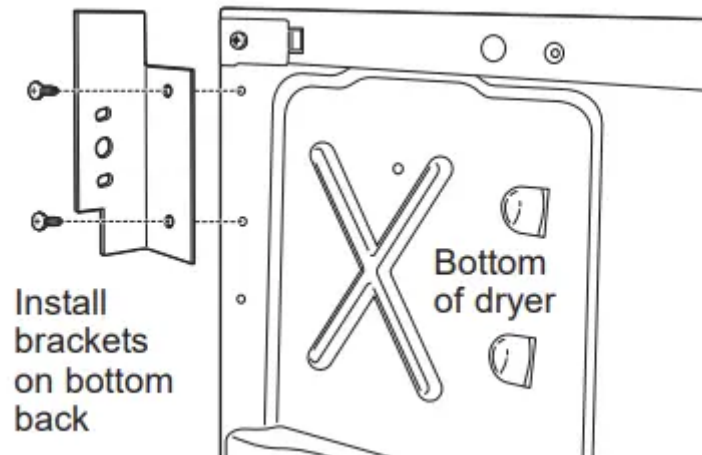

4. PREPARE WASHER AND DRYER

A. Place the washer in the approximate location.

B. Make sure the washer is level. Refer to washer Installation Instructions for details.

C. Reverse dryer door swing if desired. See Optional Instructions in this manual for details.

NOTE: The washer door swing is not reversible.

5. INSTALL DRYER AND BRACKET ON WASHER

WARNING Disconnect power before installing. Failure to do so could result in serious injury or death.

WARNING - Excessive Weight Hazard

Failure to do so may result in back or other injury, or property damage.

- Use two or more people to install dryer.
- Avoid tipping and rupture of utility services.
- Dryer must be securely attached to the washer.
- DO NOT place the washer on top of the dryer.
- Mobile Home or Manufactured Home Installation Stacking of a gas dryer is not permitted in a mobile home or manufactured home.

A. Lift the dryer on top of the washer. Be careful not to scratch the top of the washer with the brackets. Protect the washer control panel with cardboard or other protection. Be sure to lift the dryer high enough to clear the washer control panel.

B. Align the holes in the bracket with the holes in the back of the washer. Using a Phillips screwdriver, attach the 2 #8 x 1/2" tapping screws. Repeat on both sides of the washer.

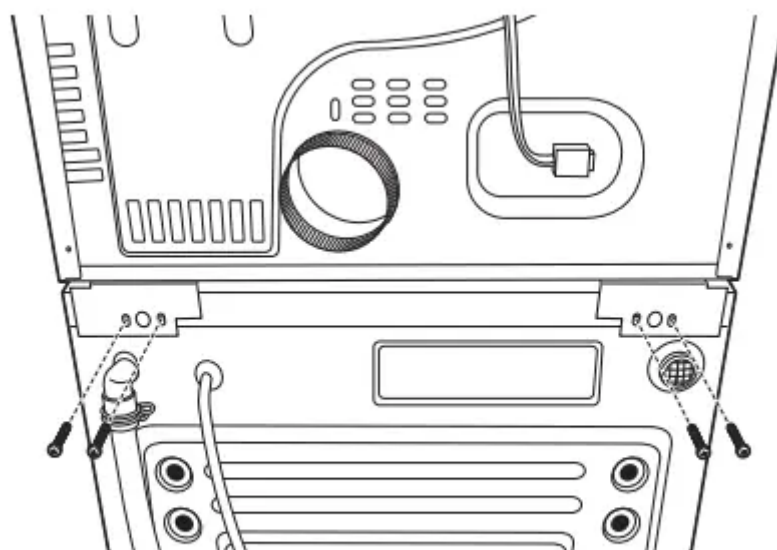

Attach brackets to
back of washer

6. FINALIZE THE INSTALLATION

CAUTION Do not push on the dryer once installed to top of the washer. Pushing on the dryer may result in pinched fingers.

A. Refer to the washer Installation Instructions to complete the washer installation.

B. Refer to the dryer Installation Instructions to complete the dryer installation.

C. Carefully slide or walk the stacked washer and dryer into place. Use felt pads or other sliding device to assist moving and to protect flooring.

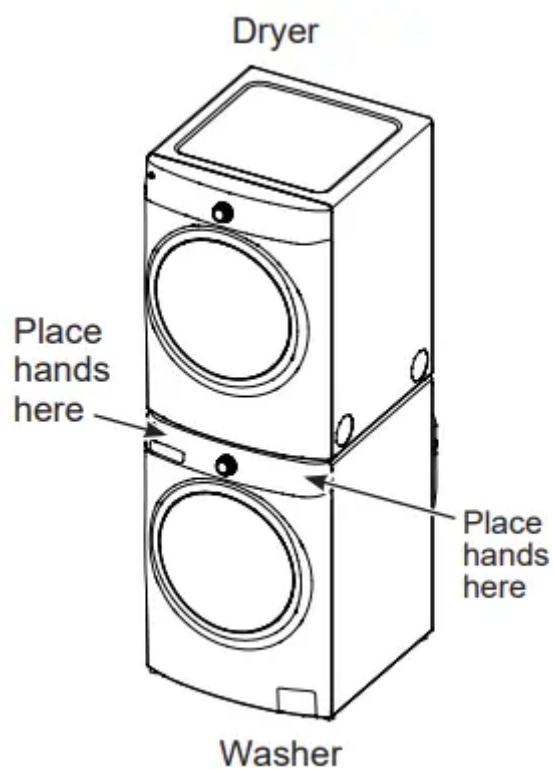

TROUBLESHOOTING TIPS

Problem	Possible Cause	What To Do
Dryer shakes or makes noise	Some shaking/noise is normal. Dryer may be sitting unevenly.	Move dryer to an even floor space, or adjust leveling legs as necessary until even.
Clothes take too long to dry	Improper or obstructed ducting	Check the Installation Instructions to make sure the dryer venting is correct. Make sure ducting is clean, free of kinks and unobstructed. Check to see if outside wall damper operates easily.
	Improper sorting	Separate heavy items from lightweight items (generally, a well-sorted washer load is a well-sorted dryer load).
	Large loads of heavy fabrics (like beach towels)	Large, heavy fabrics contain more moisture and take longer to dry. Separate large, heavy fabrics into smaller loads to speed drying time.
	Controls improperly set	Match control settings to the load you are drying.
	Lint filter is full	Clean lint filter before every load.
	Blown fuses or tripped circuit breaker	Replace fuses or reset circuit breakers. Since most dryers use 2 fuses/breakers, make sure both are operating.
	Overloading/combining loads	Do not put more than one washer load in the dryer at a time.
	Underloading	If you are drying only one or two items, add a few items to ensure proper tumbling.
eDry is enabled	The eDry feature is designed to operate your dryer in the most energy efficient mode, which is not always the fastest mode. In some instances, dry times may be extended to reduce overall energy usage for the cycle.	

The Dry dryness level was chosen but load is still damp	Load consists of a mixture of heavy and light fabrics	When combining heavy and light fabrics in a load, choose More Dry.
	Exhaust system is blocked	Inspect and clean exhaust system.
Control buttons not responding	Controls accidentally put in service mode	Press Start/Pause.
	Controls accidentally put in lock mode	Hold the eDry button for 3 seconds to unlock the dryer.
	Controls performed an incorrect operation	Reset the in-house breaker.
Dryer doesn't start	Control panel is "asleep"	This is normal. Press Power to activate the control panel.
	Dryer is unplugged	Make sure the dryer plug is pushed completely into the outlet.
	Fuse is blown/circuit breaker is tripped	Check the building's fuse/circuit breaker box and replace fuse or reset breaker. NOTE: Electric dryers use two fuses or breakers.
	Dryer was accidentally paused when starting Delay Dry	If the light on the Start/Pause button is flashing, the dryer is paused. Press Start/Pause to restart the countdown.
No numbers displayed during cycle, only lights	Dryer is continuously monitoring the amount of moisture in the clothes	This is normal. When the dryer senses a low level of moisture in the load, the dryer will display the dry time remaining.
Time Remaining jumped to a lower number	The estimated time may change when a smaller load than usual is drying	This is normal.
Cannot make a selection and the dryer beeps twice	The dryness Level, Temp or option that you are trying to select is incompatible with the chosen dry cycle	This is normal.
Dryer is running but END is displayed in Time Remaining	The Ext Tumble option was chosen	This is normal. During extended tumbling, the time remaining is not

		displayed. The extended tumbling option lasts approximately 60 minutes.
Clean Lint Filter (message)	Power button was activated	Press Start/Pause to begin a dry cycle and the message will disappear.
Dryer doesn't heat	Fuse is blown/circuit breaker is tripped; the dryer may tumble but not heat	Check the building's fuse/circuit breaker box and replace both fuses or reset both breakers. Your dryer may tumble if only one fuse is blown or one breaker tripped.
	Gas service is off (gas models only)	Make sure gas shutoff at dryer and main shutoff are fully open.
	LP gas supply tank is empty or there has been a utility interruption of natural gas (gas models only)	Refill or replace tank. Dryer should heat when utility service is restored.
Inconsistent drying times	Type of heat	Drying time will vary according to the type of heat used. If you recently changed from an electric to a gas (natural or LP) dryer, or vice versa, the drying time could be different.
	Type of load and drying conditions	The load size, types of fabric, wetness of clothes and the length and condition of the exhaust system will affect drying times.
Glow at the rear of the drum	Heaters behind the drum	This is normal. Under certain drying conditions and room ambient lighting, the glow of the heaters may be visible at the rear of the drum.
Clothes are still wet and dryer shut off after a short time	The door was opened mid-cycle. The load was then removed from the dryer and a new load put in without selecting a new cycle	A dry cycle must be reselected each time a new load is put in.
	Small load	When drying 3 items or less, choose Quick Dry or Time Dry



	Load was already dry except for collars and waistbands	Choose Quick Dry or Time Dry to dry damp collars and waistbands. In the future, when drying a load with collars and waistbands, choose More Dry.
	Dryer is not level	Move dryer to an even floor space or adjust leveling legs as necessary until even.
Clothes are wrinkled	Overdrying	Select a shorter drying time. Remove items while they still hold a slight amount of moisture. Select a Less Dry or Damp setting.
	Letting items sit in dryer after cycle ends	Remove items when cycle ends and fold or hang immediately, or use the Ext Tumble option.
	Overloading	Separate large loads into smaller ones.
Clothes shrink	Some fabrics will naturally shrink when washed. Others can be safely washed, but will shrink in the dryer.	To avoid shrinkage, follow garment care labels exactly. Some items may be pressed back into shape after drying. If you are concerned about shrinkage in a particular item, do not machine wash or tumble dry it.
Greasy spots on clothes	Improper use of fabric softener	Follow directions on fabric softener package.
	Drying dirty items with clean ones	Use your dryer to dry only clean items. Dirty items can stain clean items and the dryer.
	Clothes were not completely clean	Sometimes stains which cannot be seen when the clothes are wet appear after drying. Use proper washing procedures before drying.
Lint on clothes	Lint filter is full	Clean lint screen before each load.

	Improper sorting	Sort lint producers (like chenille) from lint collectors (like corduroy).
	Static electricity can attract lint	See suggestions in this section under Static occurs.
	Overloading	Separate large loads into smaller ones.
	Paper, tissue, etc., left in pockets	Empty all pockets before laundering clothes.
Static occurs	No fabric softener was used	Try a fabric softener. Bounce® Fabric Conditioner Dryer Sheets have been approved for use in all GE Appliances dryers when used in accordance with the manufacturer's instructions.
	Overdrying	Try a fabric softener. Adjust setting to Less Dry or Damp.
	Synthetics, permanent press and blends can cause static	Try a fabric softener.
Collars and waistbands still wet at end of cycle	The dryness monitor senses that the body of the clothes is dry	Choose Quick Dry or Time Dry to dry damp collars and waistbands. In the future, when drying a load with collars and waistbands, choose More Dry.
Slight variation in metallic color	This is normal	Due to the metallic properties of paint used for this unique product, slight variations of color may occur due to viewing angles and lighting conditions.
Dryer continues to tumble after display says Complete	Ext Tumble was selected	Ensure Ext Tumble option is not selected. For the Steam Refresh cycle, Ext Tumble will automatically be turned on and cannot be turned off.
Door is too foggy to see clothes during a steam cycle	Steam condenses on inner door	This is normal.
Water seen on inside of door and top of lint		This is normal.

filter when opening door after steam cycle	Steam condenses on these surfaces	
Small areas on clothes are damp after steam cycle	Steam condenses on inner drum	If using the Steam Dewrinkle cycle, manually reduce the cycle time. If using the Steam Refresh cycle, add more garments to the load.
Small amount of water on floor in front of dryer	Inadequate load size for steam cycle selected, excess steam condenses inside cabinet and leaks out	If using the Steam Dewrinkle cycle, manually reduce the cycle time. If using the Steam Refresh cycle, add more garments to the load.
Water on floor in back of dryer	Loose water hose connection	Tighten connection
	Hose missing rubber washer at connection with valve	Install rubber washer provided with hose.
Dryer makes water noises	Water valve is open filling steam generator	This is normal.
	Steam generator is dispensing steam into drum	This is normal.
Water drips from door when opened after a Steam Cycle	Steam condenses on inner door	This is normal.
Cannot see steam at beginning of cycle	Steam released at different times in the cycle	This is normal.
Cannot see steam during cycle	The steam nozzle might be clogged with debris from your water supply	Call GE Appliances at 877.959.8688 to order nozzle replacement kit WE25M71 or to request a technician to replace this for you.
Garments still wrinkled after steam cycle	Too many garments	Load fewer garments; manually increase time.

Warning



This content is compiled from multiple sources and is provided for reference purposes only. It may not be complete or fully applicable to all situations. If you are unable to resolve your issue, please contact the product manufacturer or an authorized service provider for official support.

Document generated by [ManualsFile](#)