

# Operating Instructions

## About the washer control panel.

Find the illustration that most closely matches your model and see the Features section starting on page 10 for details.

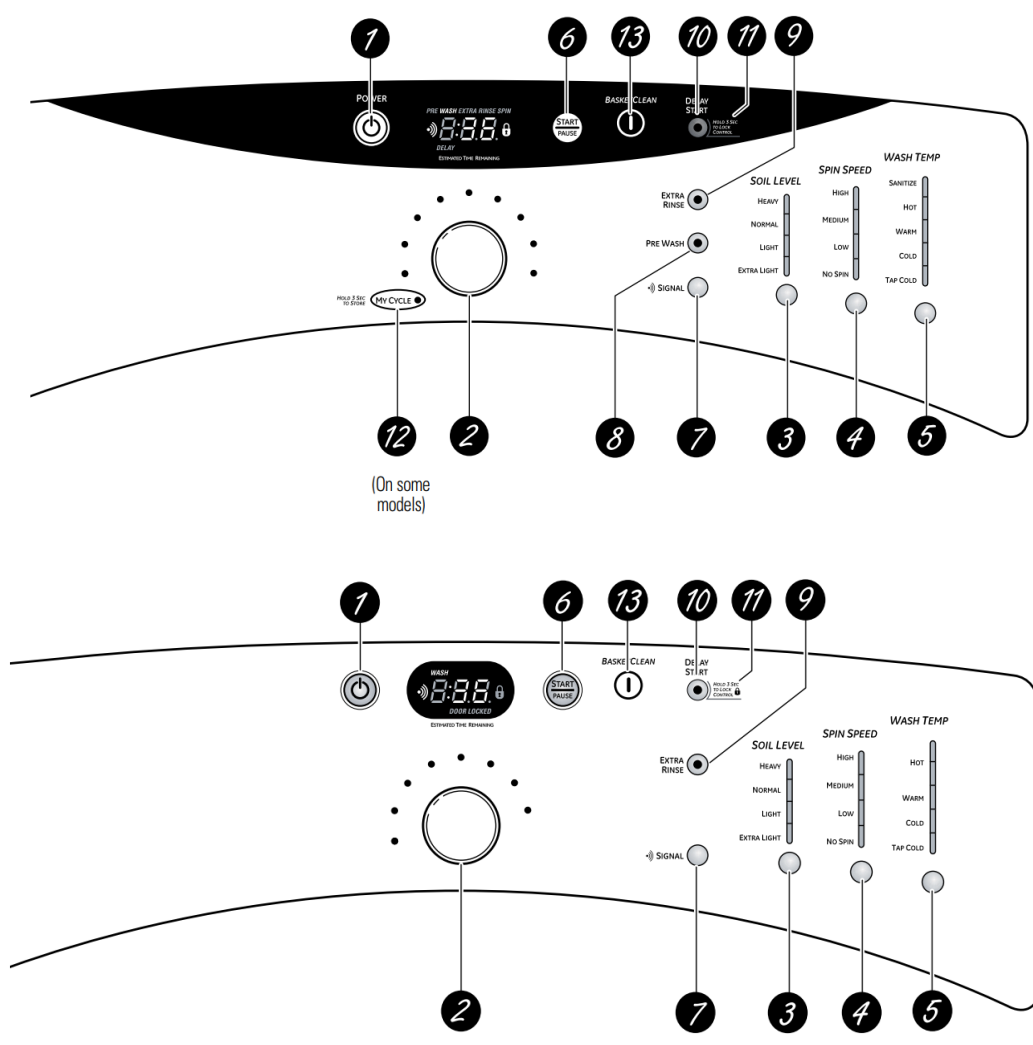

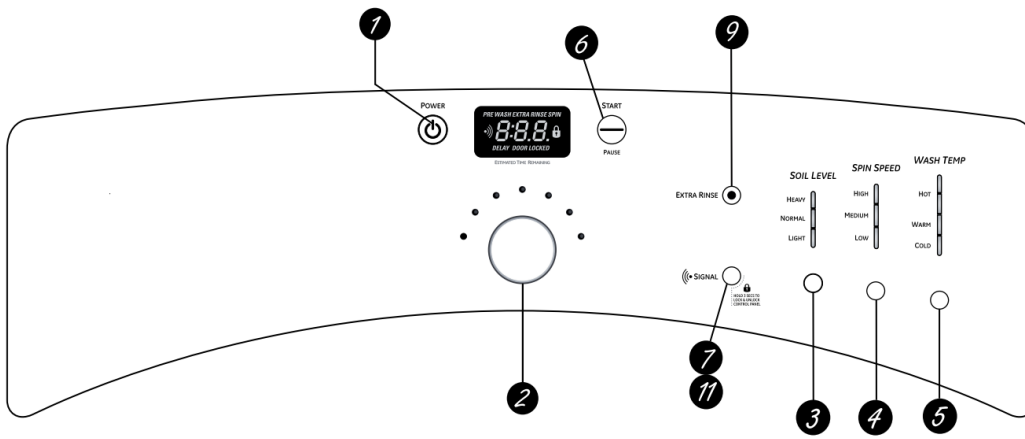
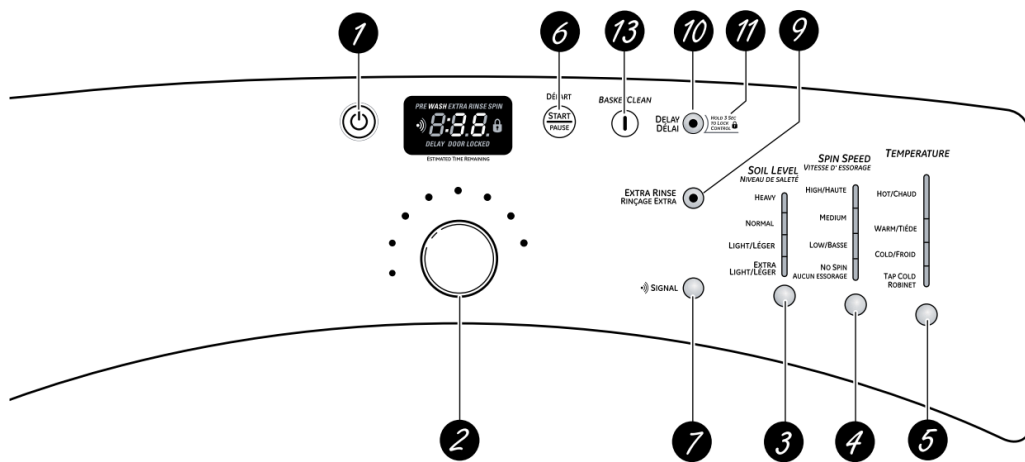
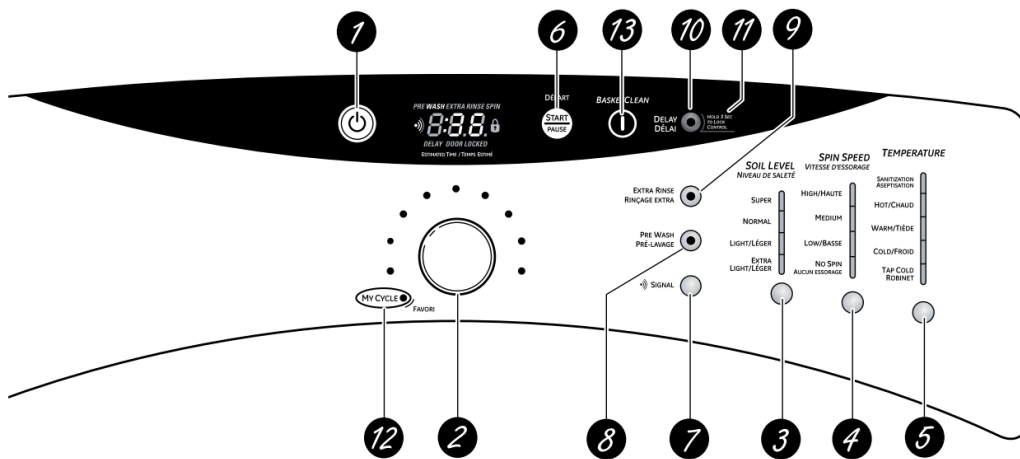

### 1. Power

Press to “wake up” the display. If the display is active, press to put the washer into standby mode.

NOTE: Pressing POWER does not disconnect the appliance from the power supply.

### 2. Wash Cycles



The wash cycles are optimized for specific types of wash loads. The chart below will help you match the wash setting with the loads. The GentleClean™ lifters lightly tumble the clothes into the water and detergent solution to clean the load.

<b>WHITES</b>	For heavily to lightly soiled white cottons, household linens, work and play clothes.
<b>COLORS/ NORMAL</b>	For heavy to lightly soiled colorfast cottons, household linens, work and play clothes.

**STAIN WASH** For heavy soiled colorfast cottons, household linens, work and play clothes.

**EASY CARE  
(PERMA PRESS)** For wrinkle-free and permanent press items.  
(some models)

<b>ACTIVE WEAR</b> (some models)	For active sports, exercise and some casual wear clothes. Fabrics include modern technology finishes and fibers such as spandex, stretch and micro-fibers
<b>DELICATES</b> (some models)	For lingerie and special-care fabrics with light to normal soil. Provides gentle tumbling and soak during wash and rinse.

**HANDWASH** For items labeled hand-washable with light soils. Provides gentle rocking to mimic the handwashing action.

<b>WASHABLE WOOLS</b> (some models)	For the washing of machine washable wool products, provided that they are washed according to the instructions on the garment label. When selecting this cycle, you must use a detergent suitable for washing wool.
-------------------------------------	---

**MY CYCLE** (some models) Press to use, create or modify custom wash cycles.

**SPEED WASH** For lightly soiled items that are needed in a hurry. Cycle time is approximately 30 minutes, depending on selected options.

**DRAIN & SPIN** Drain and spin at any time.

**RINSE & SPIN** To quickly rinse out any items at any time.  
(some models)

### 3. Soil Level

Changing the SOIL LEVEL increases or decreases the wash time to remove different amounts of soil.



To change the SOIL LEVEL, press the SOIL LEVEL button until you have reached the desired setting.

#### 4. Spin Speed

Changing the SPIN SPEED button until you have reached the desired setting manufacturer's care label when changing the SPIN SPEED.

To change the SPIN SPEED, press the SPIN SPEED button until you have reached the desired setting.

Higher spin speeds are not available on certain cycles, such as Delicates. Higher spin speeds remove more water from the clothes and will help reduce dry time, but may also increase the possibility of setting wrinkles on some fabrics.

#### 5. Wash Temp

Adjust to select the proper water temperature for the wash cycle. The prewash and rinse water is always cold to help reduce energy usage and reduce setting of stains and wrinkles.

Follow the fabric manufacturer's care label when selecting the wash temperature.

To change the wash temperature, press the WASH TEMP button until you have reached the desired setting. The Sanitized wash temperature is not available on certain cycles, such as Delicates.

When selecting the Sanitize wash temperature (on some models), the washer increases the water temperature to sanitize and kill more than 99% of many common bacteria found in home laundry. The sanitize wash temperature is only available on Stain Wash and Whites wash cycles. For best results, select the heavy soil setting when using the Sanitize wash temperature setting.

#### 6. START/PAUSE

Press to start a wash cycle. If the washer is running, pressing it once will pause the washer and unlock the door. Press again to restart the wash cycle.

NOTE: If the washer is paused and the cycle is not restarted within 2 hours, the current wash cycle will be cancelled.

NOTE: The washer performs automatic system checks after pressing the START button. Water will flow in 45 seconds or less. You may hear the door lock and unlock before water flows; this is normal

## About the washer features.



### Cycle Signal

- Use the SIGNAL button to change the volume of the end of cycle signal.
- Press the button until you reach the desired volume.



### Prewash (on some models)

- Prewash is an extra wash before the main wash. Use it for heavily soiled clothes or for clothes with a care label that recommends prewashing before the main wash. Use it for heavily soiled detergent, or the proper wash additive to the prewash dispenser.

NOTE: When selecting Srewash, it is recommended to use Powder detergent in the main wash (detergent) from Sartment.



### Extra Rinse

- Use an extra rinse when additional rinsing is desired to remove excess dirt and detergent from soiled loads.

10

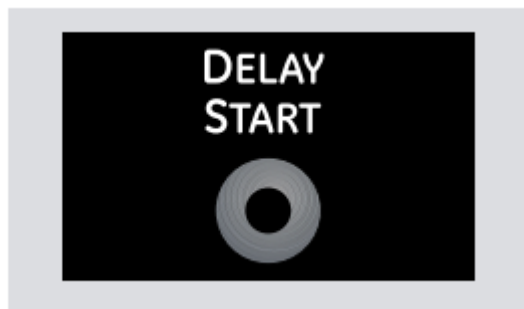

### Delay Start (on some models)

- You can delay the start of a wash cycle for 10–18 hours, depending on the model. Press the DELAY START button to choose the number of hours you want to delay the start of the cycle, then press the START button. The machine will count down and start automatically at the correct time.

NOTE: If you forget to fully close the door, a reminder signal will beep reminding you to do so.

NOTE: If you open the door when the delay is counting down, the machine will enter the Pause state. You must close the door and press START again in order to restart the countdown.

11

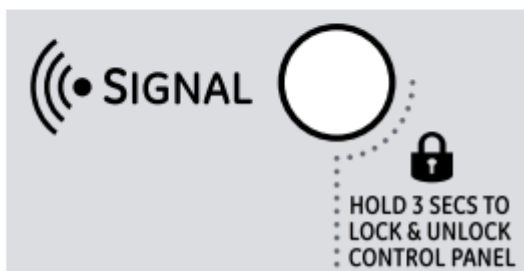

### Lock

- You can lock the controls to prevent any selections from being made. Or you can lock the controls after you have started a cycle.
- Children cannot accidentally start the washer by touching pads with this option selected.
- To lock the washer, press and hold the DELAY START button for 3 seconds (on some models use SIGNAL button). To unlock the washer controls, press and hold the DELAY START button for 3 seconds.
- The control lock icon on the display will light up when it is on.

NOTE: The POWER button Fan still be used when the maFhine is loFked.

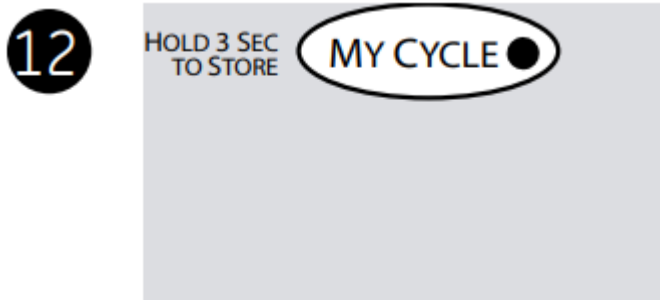

### MY CYCLE (on some models)

- To save a favorite cycle, set the desired settings for wash cycle, soil level, spin speed and wash temp settings and hold down the MY CYCLE button for 3 seconds. A beep will sound to indicate the cycle has been saved.
- To use your custom cycle, press the MY CYCLE button before washing a load.
- To change the saved cycle, set the desired settings and hold down the MY CYCLE button for 3 seconds.

NOTE: When usinJ MY CYCLE, wash oStions Fannot be modiçed after the FyFle has been started.

NOTE: If you FhanJe wash oStions with MY CYCLE before startinJ the FyFle, the MY CYCLE liJht will turn off and you will be returned to the base FyFle.



### BASKET CLEAN

- BasketClean is a cycle that freshens up the inside of your washer. The cycle uses bleach or other available washing machine cleaners and more water to refresh your washer. Use BasketClean once every month to reduce odor and residue buildup inside the washer.
- For more information on BasketClean, refer to the Care and Cleaning section on page 12.

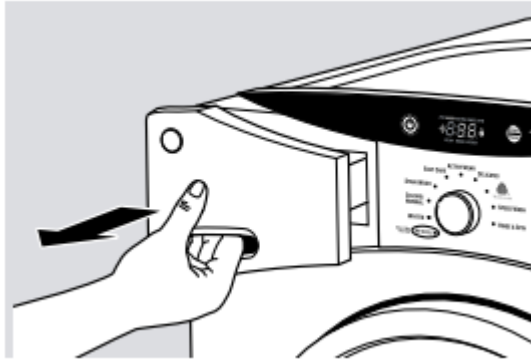

### The Dispenser Drawer

- Slowly open the dispenser drawer by pulling it out until it stops.
- After adding laundry products, slowly close the dispenser drawer. Closing the drawer too quickly could result in early dispensing of the bleach, fabric softener or detergent.
- You may see water in the bleach and fabric softener compartments at the end of the cycle. This is a result of the flushing/siphoning action and is part of the normal operation of the washer.

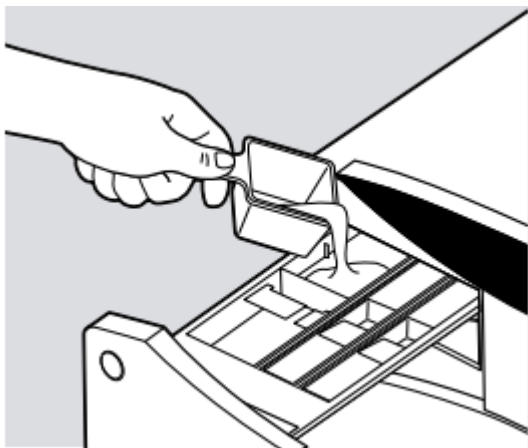

### The Prewash Compartment (on some models)

- Only use the Prewash Compartment if you are selecting the Prewash cycle for heavily soiled clothes. Add measured detergent or prewash additive to the back left prewash compartment of the dispenser drawer.
- Detergent or prewash additive is flushed from the dispenser in the prewash cycle (if selected).

NOTE: LiTuid deterJent will drain into the washer drum as it is added.

- Detergent usage may need to be adjusted for water temperature, water hardness, size and soil level of the load. Avoid using too much detergent in your washer as it can lead to over sudsing and detergent residue being left on the clothes.

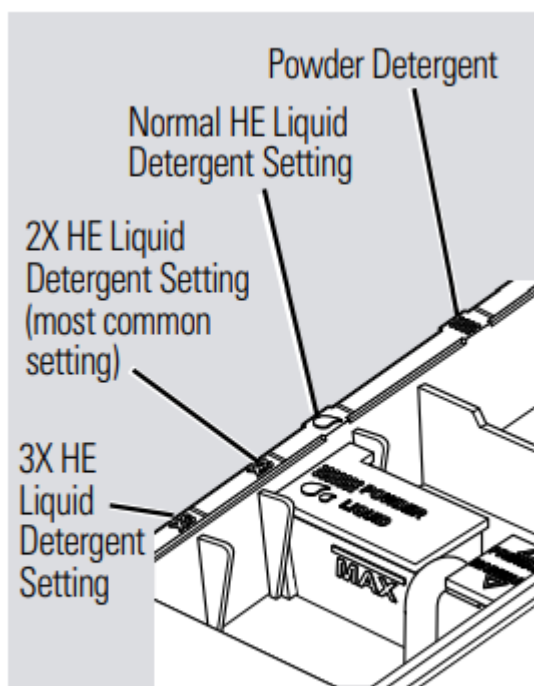

Appearance may vary

### The Detergent Compartment

- High-efficiency detergent is required for this washer. Use the detergent manufacturer's recommended amount.

The detergent selection insert must be placed in the detergent compartment in a specific position according to what type of detergent you are using.

- Powder Detergent – Place the insert in the rear position. The Powder Icons  must line up on center when the insert is in the powder position.
- Liquid Detergent – You will need to adjust the insert according to the type of Liquid Detergent you are using. The Icons on the side of the detergent compartment must line up on the center when the insert is in position.

NOTE: Not all models have the 2x and 3x detergent settings. Some have only regular HE detergent settings. You must reduce the amount of detergent for 2x or 3x detergent Ser bottle instructions.

Move the insert by pulling it up and replace it by sliding it down between either the rear or front detergent compartment molded rails, as desired, for powder or liquid detergent.

- Add measured detergent to the front left detergent compartment of the dispenser drawer.
- Detergent is flushed from the dispenser at the beginning of the wash cycle. Either powdered or liquid detergent can be used.

- Detergent usage may need to be adjusted for water temperature, water hardness, size and soil level of the load. Avoid using too much detergent in your washer as it can lead to oversudsing and detergent residue being left on the clothes.
- Using more detergent than the recommended quantity can cause residue buildup on your washer.

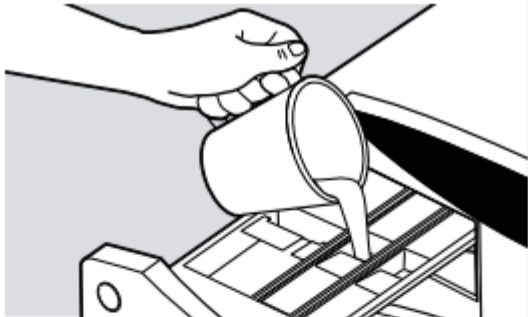

On some models, the Liquid Bleach Compartment is in the center.

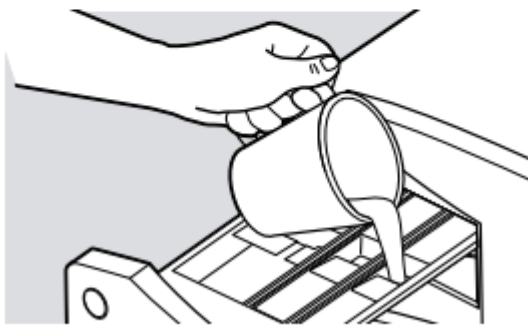

On some models, the Liquid Bleach Compartment is on the right.

### The Liquid Bleach Compartment

**IMPORTANT:** The bleach compartment position varies by model. Be sure to identify the correct compartment for bleach before using.

- If desired, measure out the recommended amount of liquid bleach, not to exceed 1/3 cup (80 ml), and pour into the center compartment labeled "LIQUID BLEACH" marked with

this symbol .

- Do not exceed the maximum fill line. Overfilling can cause early dispensing of the bleach which could result in damaged clothes.

**NOTE:** Do not use Powdered bleach in the dispenser.

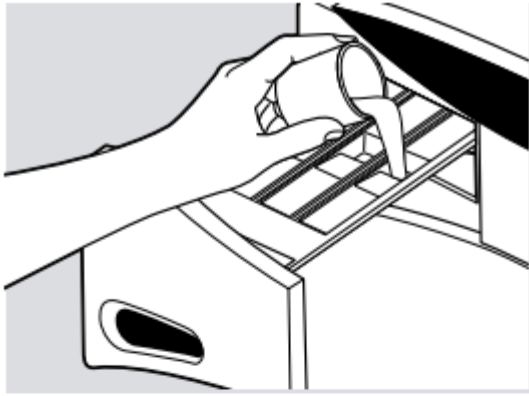

On some models, the Fabric Softener Compartment is on the right.

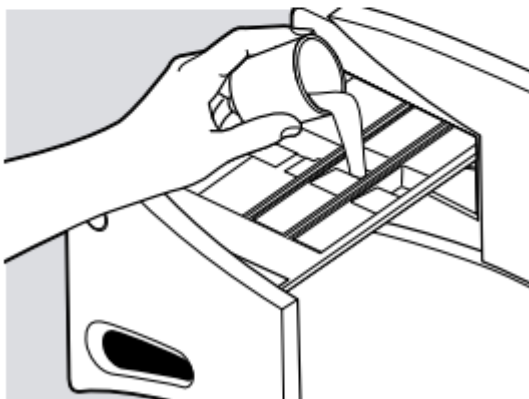

On some models, the Fabric Softener Compartment is in the center.

### **The Fabric Softener Compartment**

**IMPORTANT:** The fabric softener compartment position varies by model. Be sure to identify the correct compartment for fabric softener before using.

- If desired, pour the recommended amount of liquid fabric softener into the compartment labeled “FABRIC SOFTENER.”
- Use only liquid fabric softener in the dispenser.
- Dilute with water to the maximum fill line.
- Do not exceed the maximum fill line. Overfilling can cause early dispensing of the fabric softener which could stain clothes.

**NOTE:** Do not pour fabric softener directly on the wash load.

### **Loading and using the washer.**

Always follow fabric manufacturer's care label when laundering.



**Sorting Wash Loads**

Sort laundry into loads that can be washed together.

Colors	Soil	Fabric	Lint
Whites	Heavy	Delicates	Lint Producers
Lights	Normal	Easy Care	Lint Collectors
Darks	Light	Sturdy Cottons	

- Combine large and small items in a load. Load large items first. Large items should not be more than half the total wash load.
- Washing single items is not recommended. This may Cause an out-of-balance load. Add one or two similar items.
- Pillows and Comforters should not be mi[ed with other items. This may Cause an out-of-balance load.

**Preparing Clothes**

- To avoid snags during washing: Follow these steps to maximize garment care.
  - Close garment zippers, snaps, buttons and hooks.
  - Mend seams, hems, tears.
  - Empty all items from SoFkets.
  - RemoYe nonwashable Jarment accessories such as ornaments and nonwashable trim materials.
- To avoid tangling, tie strings, draw ties and belt-like materials.
- Brush away surface dirt and lint treat spots and stains.
- PromStly wash wet or stained Jarments to maximize results.
- MixGarments using recommended maximum load sizes on page 11.
- Use nylon mesh garment bags to wash small items.
- Wash multiple garments at one time for best results.





### **Loading the Washer**

Wash drum may be fully loaded with loosely added items. Do not wash fabrics containing flammable materials ( waxes, cleaning fluids, etc..)

To add items after washer has started, press START/PAUSE and wait until the door is unlatched. The washer may take up to 30 seconds to unlock the door after pressing START/PAUSE depending on the machine conditions. Do not try to force open the door when it is locked. After the door unlocks, open gently. Add items, close the door and press START/PAUSE to restart.

### **Maximum Loading Sizes\***

<b>WORKWEAR</b>	<b>LINENS</b>	<b>MIXED LOAD</b>	<b>DELICATES**</b>	<b>SPEED WASH (2-4 GARMENTS)</b>
1. Jeans 2. Workwear Shirts 5 Workwear Pants	2 Bath Sheets 10 Bath Towels/ 12 Washcloths 7 Hand Towels/ 2 Terrycloth Bath Mats <b>OR</b> 2 Flat Queen- Sized Sheets 2 Fitted Queen-Sized Sheets 4 Pillowcases	4 Pillowcases 2 Hand Towels 2 Flat Sheets/ 2 Fitted Sheets 2 Bath Towels/ 4 Washcloths <b>OR</b> 6 Shirts (Men's or Women's) 1. Pair Pants (Khakis or Twills) 1. T-Shirts 7 Pairs of Boxers 4 Pairs of Shorts <b>OR</b> 6 T-Shirts 4 Pairs of Sweatpants 4 Sweatshirts 2 Hoodies 7 Pairs of Socks	7 Bras 7 Panties 3 Slips 2 Camisoles 4 Nightgowns	2 Casual Wear Work Shirts 1 Pair Casual Wear Work Pants <b>OR</b> 3 Soccer Uniforms

- Exceeding maximum recommended load sizes may affect cleaning performance and garment care.

\*\*Using a nylon mesh bag for small items is recommended.



## Cleaning the washer



### Care and Cleaning

- Exterior: Immediately wipe off any spills. Wipe with damp cloth. Do not hit surface with sharp objects
- Moving and Storage: Ask the service technician to remove water from drain pump and hoses. Do not store the washer where it will be exposed to the weather. When moving the washer, the tub should be kept stationary by using the shipping bolts removed during installation. See Installation Instructions in this book. If these parts are not available, they can be ordered by visiting our Website at [GEAppliances.com](http://GEAppliances.com) or by calling 800.GE.CARES.
- Long Vacations: Be sure the water supply is shut off at the faucets. Drain all water from the hoses if the weather will be below freezing

### Cleaning the Interior of the Washer

To clean the interior of the washer, select the BasketClean feature on the control panel. The cycle will use more water, in addition to bleach, to refresh your washer.

NOTE: Read the instructions below completely before starting the BasketClean cycle.

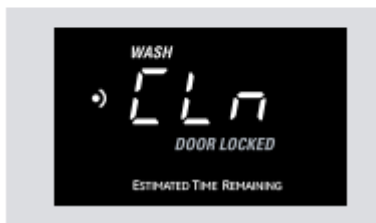
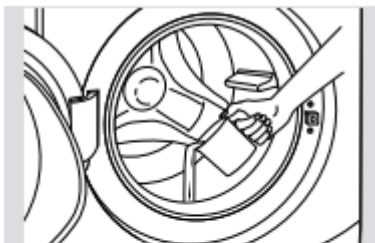

1. Remove any garments or objects from the washer and ensure the washer basket is empty.
2. Open the washer door and pour one cup or 250 ml of liquid bleach or other washing machine cleaner into the basket.
3. Close the door and select the BasketClean cycle. Push the START button.
4. When the BasketClean cycle is working, you will see CLN on the display. The cycle will complete in about 90 minutes. Do not interrupt the cycle.

5. After the cycle is complete, leave the door open slightly for better ventilation.

If for any reason the cycle needs to be interrupted, the door will not open immediately. Forcing open the door at this stage may cause water to flood. The door will open after the water is drained to a level where it would not flood the floor.

BasketClean may be interrupted by pressing the START/PAUSE button in between cycles. A power outage in the house might also interrupt the cycle. When the power supply is back, the BasketClean cycle resumes where it had stopped. When interrupted, be sure to run a complete BasketClean cycle before using the washer. If the POWER button is pressed during BasketClean, the cycle will be lost.

**IMPORTANT:**

- Run BasketClean with 1 Cup (250 ml) of bleach once a month.
- After the completion of a BasketClean cycle, the interior of your washer may have a bleach smell.
- It is recommended to run a light color load after the BasketClean cycle.

**Cleaning the Pump Filter**

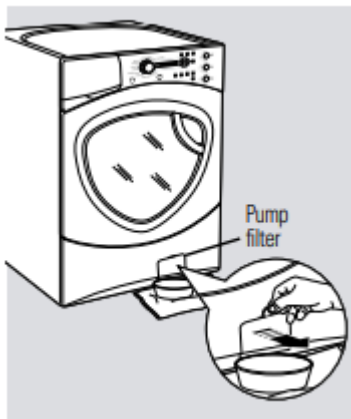

Due to the nature of the front-load washer, it is sometimes possible for small articles to pass to the pump. The washer has a filter to capture lost items so that are not dumped to the drain. To retrieve lost items, clean out the pump filter

1. Using a coin or flat screwdriver in the notch on the door, open the access door.
2. Place a shallow pan or dish under the pump access door and towels on the floor in front of the washer to protect the floor. It is normal to catch about a cup of water when the filter is removed.





3. Pull down the pour spout.

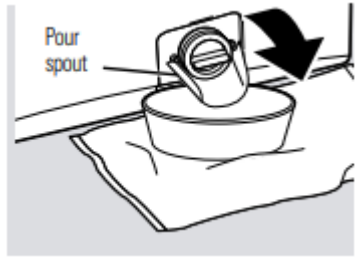

4. Turn the pump filter counterclockwise and remove the filter. Open slowly to allow the water to drain.

5. Clean the debris from the filter

6. Replace the filter and turn clockwise Tighten securely.

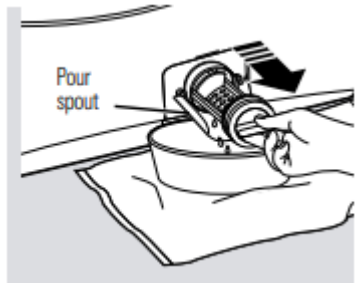

7. Flip up the pour spout.

8. Close the access door.



## Cleaning the Door Gasket

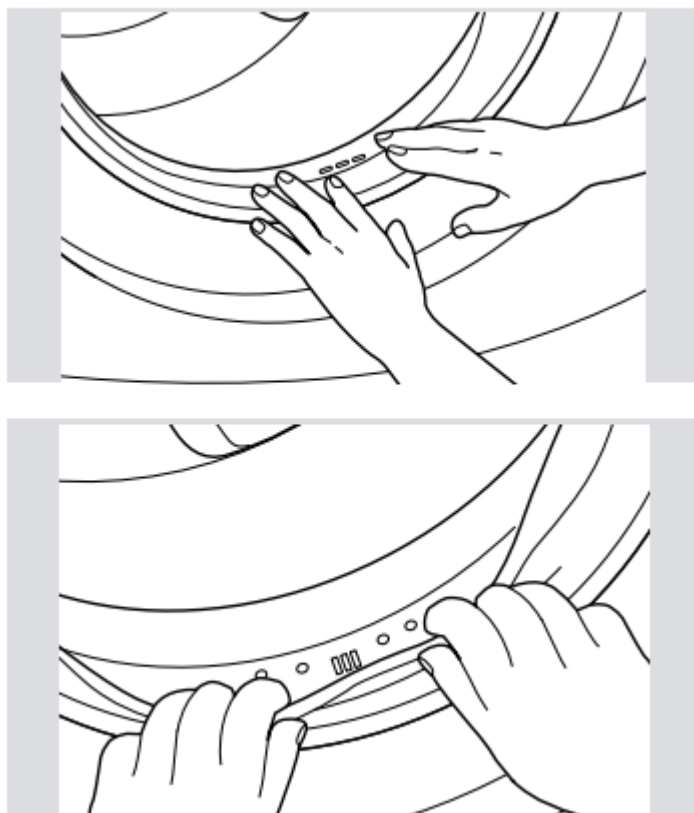

- Open the washer door. Using both hands, press down the door gasket. Remove any foreign objects if found trapped inside the gasket. Make sure there is nothing blocking the holes behind the gasket.
- While holding down the door gasket, inspect the interior gasket by pulling it down with your fingers. Remove any foreign objects if found trapped inside this gasket. Make sure there is nothing blocking the holes behind the gasket.
- When you are finished cleaning the door gasket, remove your hands and the gasket will return to the operating position.

**Dispenser Drawer Area:** Detergent and fabric softener may build up in the dispenser drawer. Residue should be removed once or twice a month. To remove the drawer by first pulling it out until it stops. Then reach back into the left rear corner of the drawer cavity and press down firmly on the lock tab, pulling out the drawer

- Remove the inserts from the bleach and fabric softener compartments and the detergent insert. Rinse the inserts and the drawer with hot water to remove traces of accumulated laundry products.

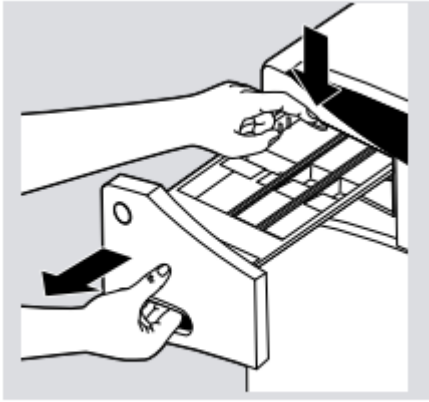

Lock tab is visible only after drawer has been pulled out

- To clean the drawer opening, use a small brush to clean the recess. Remove all residue from the upper and lower parts of the recess.

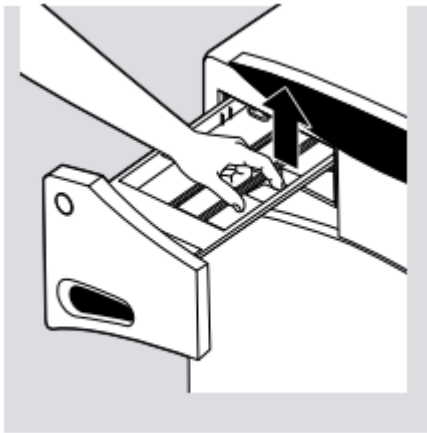

- Return inserts to the proper compartments. Replace the dispenser drawer.

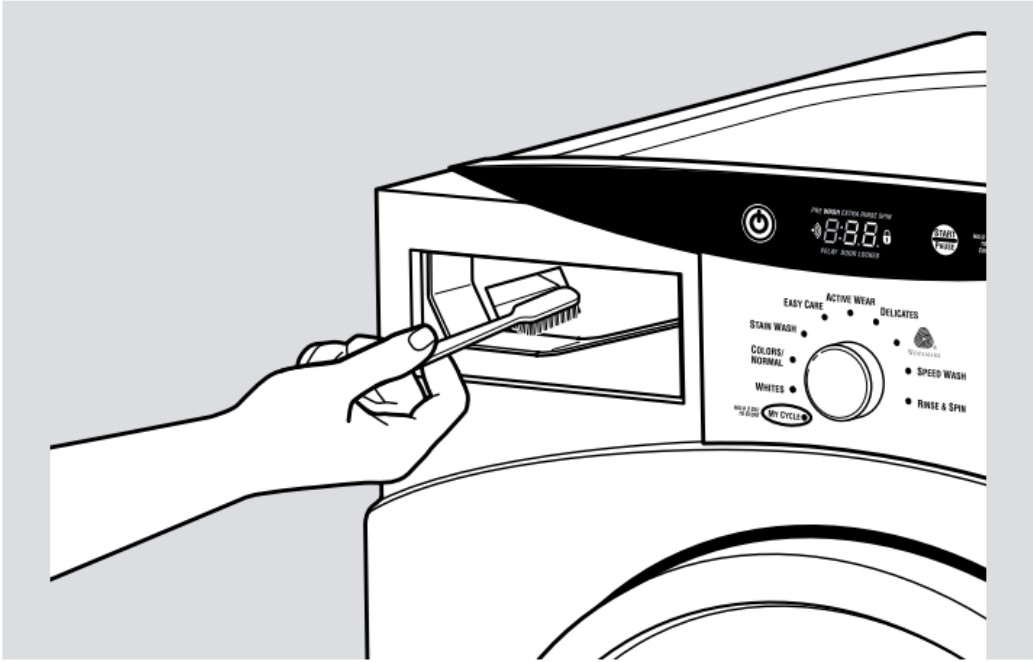

## Troubleshooting Tips



<b>Problem</b>	<b>Possible Cause</b>	<b>What To Do</b>
Not draining Not spinning Not agitating	Load is out of balance	<ul style="list-style-type: none"> <li>• Redistribute clothes and run drain &amp; spin or rinse &amp; spin</li> <li>• Increase load size if washing small load containing heavy and light items</li> </ul>
	Pump clogged	<ul style="list-style-type: none"> <li>• See page 13 on how to clean the Pump Filter.</li> </ul>
	Drain hose is kinked or improperly connected	<ul style="list-style-type: none"> <li>• Straighten drain hose and make sure washer is not sitting on it.</li> </ul>
	Household drain may be clogged	<ul style="list-style-type: none"> <li>• Check household plumbing. You may need to call a plumber.</li> </ul>
	Drain hose siphoning; drain hose pushed too far down the drain	<ul style="list-style-type: none"> <li>• Ensure there is an air gap between hose and drain.</li> </ul>
Leaking water	Door gasket is damaged	<ul style="list-style-type: none"> <li>• Check to see if gasket is seated and not torn. Objects left in pockets may cause damage to the washer (nails, screws, pens, pencils).</li> </ul>
	Door gasket not damaged	<ul style="list-style-type: none"> <li>• Water may drip from the door when the door is opened. This is a normal operation.</li> <li>• Carefully wipe off rubber door seal. Sometimes dirt or clothing is left in this seal and can cause a small leak.</li> </ul>

	Check back left of washer for water	<ul style="list-style-type: none"> <li>• If this area is wet, you have oversudsing condition. Use less detergent.</li> </ul>
	Fill hoses or drain hose is improperly connected	<ul style="list-style-type: none"> <li>• Make sure hose connections are tight at washer and faucets and make sure end of drain hose is correctly inserted in and secured to drain facility.</li> </ul>
	Household drain may be clogged	<ul style="list-style-type: none"> <li>• Check household plumbing. You may need to call a plumber.</li> </ul>
	Dispenser clogged	<ul style="list-style-type: none"> <li>• Powder soap may cause clogs inside the dispenser and cause water to leak out the front of the dispenser. Remove drawer and clean both drawer and inside of dispenser box. Please refer to Cleaning the Washer section.</li> </ul>
	Incorrect use of detergent	<ul style="list-style-type: none"> <li>• Use HE and correct amount of detergent.</li> </ul>
	Dispenser box crack	<ul style="list-style-type: none"> <li>• If new installation, check for crack on inside of dispenser box</li> </ul>
Clothes too wet	Load is out of balance	<ul style="list-style-type: none"> <li>• Redistribute clothes and run drain &amp; spin or rinse &amp; spin.</li> <li>• Increase load size if washing small load containing heavy and light items.</li> <li>• The machine will slow the spin speed down to 410 rpm if it</li> </ul>

		has a hard time balancing the load. This speed is normal.
	Pump clogged	<ul style="list-style-type: none"> <li>• See page 13 on how to clean the Pump Filter.</li> </ul>
	Overloading	<ul style="list-style-type: none"> <li>• The dry weight of the load should be less than 16 lb.</li> </ul>
	Drain hose is kinked or improperly connected	<ul style="list-style-type: none"> <li>• Straighten drain hose and make sure washer is not sitting on it</li> </ul>
	Household drain may be clogged	<ul style="list-style-type: none"> <li>• Check household plumbing. You may need to call a plumber.</li> </ul>
	Drain hose siphoning; drain hose pushed too far down the drain	<ul style="list-style-type: none"> <li>• Ensure there is an air gap between hose and drain.</li> </ul>
Incomplete cycle or timer not advancing	Automatic load redistribution	<ul style="list-style-type: none"> <li>• Time adds 3 minutes to oc for each rebalance 11 or 15 rebalances may be done. This is normal operation. Do nothing, the machine will finish the wash cycle.</li> </ul>
	Pump clogged	<ul style="list-style-type: none"> <li>• See page 13 on how to clean the Pump Filter.</li> </ul>
	Drain hose is kinked or improperly connected	<ul style="list-style-type: none"> <li>• Straighten drain hose and make sure washer is not sitting on it.</li> </ul>



	Household drain may be clogged	<ul style="list-style-type: none"> <li>• Check household plumbing. You may need to call a plumber.</li> </ul>
	Drain hose siphoning; drain hose pushed too far down the drain	<ul style="list-style-type: none"> <li>• Ensure there is an air gap between hose and drain.</li> </ul>
Loud or unusual noise; vibration or shaking	Cabinet moving	<ul style="list-style-type: none"> <li>• Washer is designed to move 1/4" to reduce forces transmitted to the floor. This movement is normal</li> </ul>
	All rubber leveling legs are not firmly touching the floor	<ul style="list-style-type: none"> <li>• Push and pull on the back right and then back left of your washer to check if it is level. If the washer is uneven, adjust the rubber levelling legs so they are all firmly touching the floor and locked it place. Your installer should correct this problem.</li> </ul>
	Unbalanced load	<ul style="list-style-type: none"> <li>• Open door and manually redistribute load. To check machine, run rinse and spin with no load. If normal, unbalance was caused by load.</li> </ul>
	Pump clogged	<ul style="list-style-type: none"> <li>• See page 13 on how to clean the Pump Fiter.</li> </ul>
No power/ washer not working or dead	Washer is unplugged	<ul style="list-style-type: none"> <li>• Make sure cord is plugged securely into a working outlet.</li> </ul>
	Water supply is turned off	<ul style="list-style-type: none"> <li>• Turn both hot and cold faucets fully on</li> </ul>

	Circuit breaker/fuse is tripped/blown	<ul style="list-style-type: none"> <li>• Check house circuit breakers/ fuses. Replace fuses or reset breaker. Washer should have separate outlet.</li> </ul>
	Automatic self system checks	<ul style="list-style-type: none"> <li>• First time the washer is plugged in, automatic checks occur. It may take up to 20 seconds before you can use your washer. This is normal operation.</li> </ul>
Snags, holes, tears, rips or excessive wear	Overloaded	<ul style="list-style-type: none"> <li>• Do not exceed maximum recommended load sizes. See recommended maximum load sizes on page 11.</li> </ul>
	Pens, pencils, nails, screws or other objects left in pockets	<ul style="list-style-type: none"> <li>• Remove loose items from pockets.</li> </ul>
	Pins, snaps, hooks, sharp buttons, belt buckles, zippers and sharp objects left in pockets	<ul style="list-style-type: none"> <li>• Fasten snaps, hooks, buttons and zippers</li> </ul>
Control time wrong or changes	This is normal	<ul style="list-style-type: none"> <li>• During spin the washer may need to rebalance the load sometimes to reduce vibrations. When this happens, the estimated time is increased causing time left to increase or jump.</li> </ul>
Not enough water	This is normal	<ul style="list-style-type: none"> <li>• Horizontal washers do not require the tub to fill with water like top-load washers.</li> </ul>

Washer pauses or has to be restarted, or washer door is locked and will not open	Pump clogged	<ul style="list-style-type: none"> <li>• See page 13 on how to clean the Pump Filter.</li> </ul>
Door unlocks or press START and machine doesn't operate	This is normal	<ul style="list-style-type: none"> <li>• Front-load washers start up different Crosphere and ekes B0 seconds to check eaten. The door will lock and unlock.</li> </ul>
	Incorrect operation	<ul style="list-style-type: none"> <li>• Simply open and close the door firmly; then press START.</li> </ul>
Water does not enter washer or enters slowly	Automatic self system checks	<ul style="list-style-type: none"> <li>• After START is pressed. the washer does several system checks. Water will flow 60 seconds after START is pressed.</li> </ul>
	Water supply is turned off	<ul style="list-style-type: none"> <li>• Turn on both hot and cold faucets fully.</li> </ul>
	Water valve screens are stopped up	<ul style="list-style-type: none"> <li>• Turn off the water source and remove the water connection hoses from the upper back of the washer. Use a brush or toothpick to clean the screens in the machine. Reconnect the hoses and tum the water back on.</li> </ul>
Wrinkling	Improper sorting	<ul style="list-style-type: none"> <li>• Avoid mixing heavy items (like work clothes) with light tame the blouses</li> </ul>
	Overloading	

		<ul style="list-style-type: none"> <li>• Load your washer so clothes have enough room to move freely.</li> </ul>
	Incorrect wash cycle	<ul style="list-style-type: none"> <li>• Match cycle selection to the type of fabric you are washing (especially for easy care loads)</li> </ul>
	Repeated washing in water that is too hot	<ul style="list-style-type: none"> <li>• Wash in warm or cold water.</li> </ul>
Grayed or yellowed clothes	Not enough detergent	<ul style="list-style-type: none"> <li>• Use correct amount of detergent.</li> </ul>
	Not using HE (high-efficiency )	<ul style="list-style-type: none"> <li>• Use HE detergent.</li> </ul>
	Hard water	<ul style="list-style-type: none"> <li>• Use hottest water safe for fabric.</li> <li>• Use a water conditioner like Calgon brand or install a water softener.</li> </ul>
	Water is not hot enough	<ul style="list-style-type: none"> <li>• Make sure water heater is delivering water at 120°-140°F (48°-60°C).</li> </ul>
	Detergent is not dissolving	<ul style="list-style-type: none"> <li>• Try aliquid detergent.</li> </ul>
	Dye transfer	<ul style="list-style-type: none"> <li>• Sort clothes by color. If fabric label states wash separately, unstable dyes may be indicated.</li> </ul>
Colored spots	Incorrect use of fabric softener	<ul style="list-style-type: none"> <li>• Check fabric softener package for instructions and follow directions for using dispenser.</li> </ul>

	Dye transfer	<ul style="list-style-type: none"> <li>• Sort whites or lightly colored items from dark colors</li> <li>• Promptly remove wash load from washer.</li> </ul>
Water temperature is incorrect	Water supply is improperly connected	<ul style="list-style-type: none"> <li>• Make sure hoses are connected to correct faucets.</li> </ul>
	House water heater is not set properly	<ul style="list-style-type: none"> <li>• Make sure house water heater is delivering water at 120°-140°F (48°-60°C).</li> </ul>
Slight variation in metallic color	This is normal	<ul style="list-style-type: none"> <li>• Due to the metallic properties of paint used for this unique product. slight variations of color may occur due to viewing angles and lighting conditions.</li> </ul>
Bad odor inside your washer	Washer unused for a long time, not using recommended quality of HE detergent or used too much detergent	<ul style="list-style-type: none"> <li>• In the case of strong odor. you may need to run the In cycle moye than once.</li> <li>• Use only the amount of detergent recommended on the detergent container.</li> <li>• Use only HE (high-efficiency) detergent.</li> <li>• Atways remove wet tems fom the washer promptly ater jine stops running.</li> <li>• Leave the door slightly open for the water to air dry. Close supervision is necessary if this appliance is used by or near children. Do not allow children to play on, with or inside this or any other appliance.</li> </ul>



Detergent leak	Incorrect placement of detergent insert	<ul style="list-style-type: none"> <li>• Make sure detergent insert is properly located and fully seated. Never put detergent above max line</li> </ul>
	This is normal	<ul style="list-style-type: none"> <li>• It is normal operation to see detergent leak on door gasket about 20 seconds after filling the Dispense</li> </ul>
Improper dispensing of softener or bleach	Dispenser clogged	<ul style="list-style-type: none"> <li>• Monthly clean the dispenser drawer to remove buildup of chemicals</li> </ul>
	Softener or bleach is filled above the max line	<ul style="list-style-type: none"> <li>• Make sure to have the correct amount of softener or bleach.</li> </ul>
	Softener or bleach cap issue	<ul style="list-style-type: none"> <li>• Make sure softener and bleach cap for dispenser are seated or they will not work.</li> </ul>

### Warning

This content is compiled from multiple sources and is provided for reference purposes only. It may not be complete or fully applicable to all situations. If you are unable to resolve your issue, please contact the product manufacturer or an authorized service provider for official support.

