

TV Control Switch & Operation

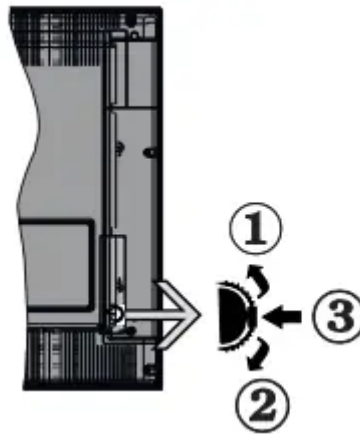

1. Up direction

2. Down direction

3. Volume / Info / Sources List selection and Standby-On switch

The Control button allows you to control the Volume / Programme / Source and Standby-On functions of the TV.

To change volume: Increase the volume by pushing the button up. Decrease the volume by pushing the button down.

To change channel: Press the middle of the button in, the information banner will appear on the screen. Scroll through the stored channels by pushing the button up or down.

To change source: Press the middle of the button in twice (for the second time in total), the source list will appear on the screen. Scroll through the available sources by pushing the button up or down.

To turn the TV off: Press the middle of the button in and hold it down for a few seconds, the TV will turn into standby mode.

To turn on the TV: Press the middle of the button in, the TV will turn on.

Notes:

- If you turn the TV off, this cycle starts again beginning with the volume setting.
- Main menu OSD cannot be displayed via control button.

Operation with the Remote Control

Press the Menu button on your remote control to display main menu. Use the directional buttons and OK button to navigate and set. Press Return/Back or Menu button to quit a menu screen.

Input Selection

Once you have connected external systems to your TV, you can switch to different input sources. Press the Source button on your remote control consecutively to select the different sources.

Changing Channels and Volume

You can change the channel and adjust the volume by using the Programme +/- and Volume +/- buttons on the remote.

Using Main TV Menu

When the Menu button is pressed, the main TV menu will appear at the bottom of the screen. You can navigate through the menu items using the directional buttons on the remote. To select an item or see the sub-menu options of the highlighted menu press OK button. When you highlight a menu option some of the sub-menu items of this menu may appear on the upper side of the menu bar for quick access. To use a quick access item, highlight it, press OK and set as desired using the Left/Right directional buttons. When finished press OK or Back/Return button to exit.

Press Exit button to close the main menu.

1. Home

When main menu is opened Home menu bar will be highlighted. The content of the Home menu can be customised by adding options from other menus. Just highlight an option and press the Down direction button on the remote. If you see Add to Home option you can add it to the Home menu. Same way you can delete or change the position of any item in the Home menu. Press the Down direction button and select the delete or move icon and press OK. In order to move a menu item use the Right and Left direction buttons to select the position that you want the item to move to and press OK.

2. TV

2.1. Guide

You can access the electronic programme guide menu using this option. Refer to Electronic Programme Guide section for more information.

2.2. Channels

You can access the Channels menu using this option. Refer to Using the Channel List section for more information.

2.3. Timers

You can set timers for future events using the options of this menu. You can also review the previously created timers under this menu.

To add a new timer select the Add Timer tab using the Left/Right buttons and press OK. Set the sub-menu options as desired and when finished press OK. A new timer will be created.

To edit a previously created timer, highlight that timer, select the Edit Selected Timer tab and press OK. Change the sub-menu options as desired and press OK to save your settings.

To cancel an already set timer, highlight that timer, select Delete Selected Timer tab and press OK. A confirmation message will be displayed. Highlight Yes and press OK to proceed. The timer will be cancelled.

It is not possible to set timers for two or more events that will be broadcasted in different channels at the same time interval. In this case you will be asked to choose one of these timers and cancel others. Highlight the timer you want to cancel and press OK, Options menu will be displayed. Then highlight Set/Cancel and press OK to cancel that timer. You will have to save changes after that. In order to do that press OK, highlight Save Changes and press OK again.

2.4. Recordings

You can manage your recordings using the options of this menu. You can playback, edit, delete or sort previously recorded events. Highlight a tab by using the Left or Right direction button and press OK to see available options.

Recording Settings

You can also configure your recording preferences using the Settings tab in the Recordings menu. Highlight Settings tab by using Left or Right button and press OK. Then select the desired item in the sub-menu and set by using Left or Right button.

Start early: You can set recording timer's starting time to start earlier by using this setting.

End late: You can set recording timer's end time to end later by using this setting.

Max Timeshift: This setting allows you to set the maximum duration for the timeshift recording. Available options are approximate and the actual recording time may change in practice depending on the broadcast. The reserved and free storage space values will change according to this setting. Make sure that you have enough free space otherwise instant recording may not be possible.

Auto discard: You can set the Discard type as None, Oldest, Longest or Shortest. If it is not set to None, you can set the Unplayed option as Included or Excluded. These options determine the preferences for deleting the recordings in order to obtain more storage space for ongoing records.

Hard disk information: You can view detailed information about the USB storage device connected to your TV. Highlight and press OK to see and press Back/Return to close.

Format Disk: If you want to delete all files on the connected USB storage device and convert the disk format to FAT32, you can use this option. Press OK button while the Format Disk option is highlighted. A menu will appear on the screen, requiring you to enter the PIN(*). After you enter the PIN, a confirmation message will be displayed. Select Yes and press OK to start formatting the USB storage device. Select No and press OK to cancel.

(*) Default PIN could have been set to 0000 or 1234. If you have defined the PIN(is requested depending on the country selection) during the First Time Installation use the PIN that you have defined.

3. Settings

You can manage the settings of your TV using the options of this menu. Refer to Settings Menu Contents section for more information.

4. Apps

When your TV is connected to the Internet related contents will also be available, including Apps related contents. Using the Apps menu you can access and manage your applications. You can add new apps from the market or delete the existing ones. Refer to Apps section for more information.

5. Source

You can manage your input source references using the options of this menu. To change the current source highlight one of the options and press OK.

5.1. Source Settings

Edit the names, enable or disable selected source options. There are also Regular, Enhanced and Disabled options available for HDMI sources. Regular and Enhanced options are affecting the colour settings of the selected HDMI source. To be able to watch 4K or HDR/HLG images from an HDMI source related source setting should be set as Enhanced if the connected device is compatible with HDMI 2.0 and subsequent versions. Set as Regular if the connected device is HDMI 1.4 compatible. Set accordingly or disable the related HDMI source by setting as Disabled.

Inserting the Batteries into the Remote

Remove the back cover to reveal the battery compartment. Insert two size AAA batteries. Make sure the (+) and (-) signs match (observe correct polarity). Do not mix old and new batteries. Replace only with same or equivalent type. Place the cover back on. A message will be displayed on the screen when the batteries are low and must be replaced.

Note that when the batteries are low, the performance of the remote control may be impaired.

Power Connection

IMPORTANT: The TV set is designed to operate on a 220- 240V AC, 50 Hz supply. After unpacking, allow the TV set to reach the ambient room temperature before you connect the set to the mains. Plug the power cable to the mains socket outlet.

Antenna Connection

Connect the aerial or cable TV plug to the AERIAL INPUT (ANT) socket or satellite plug to the SATELLITE INPUT (LNB) socket located on the rear side of the TV.

Rear side of the TV

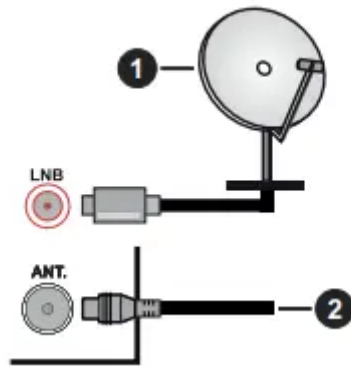

1. Satellite

2. Aerial or cable



If you want to connect a device to the TV, make sure that both the TV and the device are turned off before making any connection. After the connection is done, you can turn on the units and use them.

Remote Control

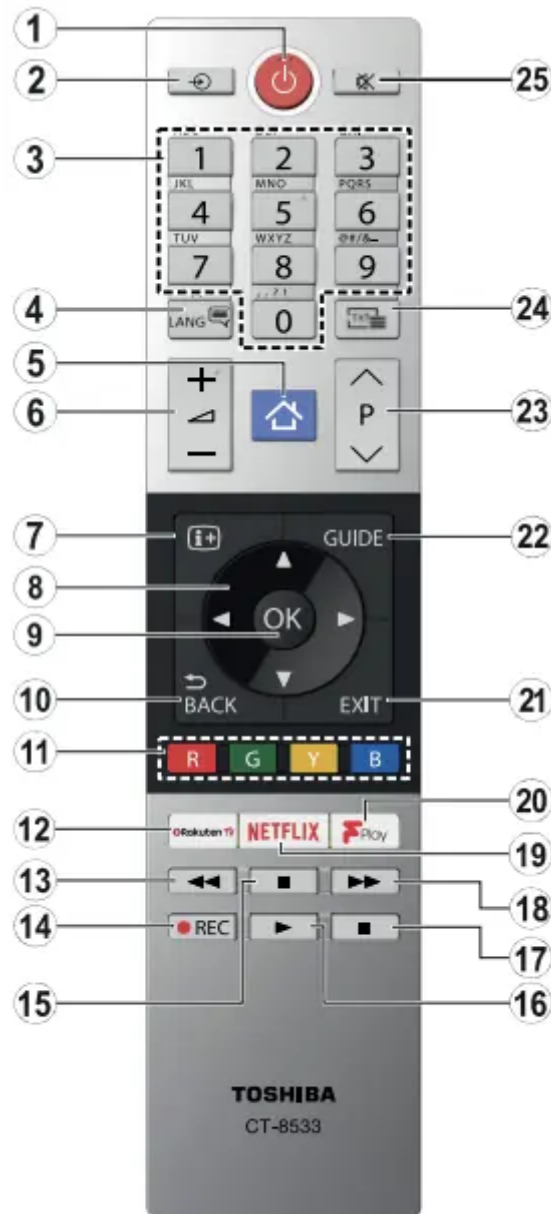

1. Standby: Switches On / Off the TV

2. Source: Shows available broadcast and content sources

3. Numeric buttons: Switches the channel, enters a number or a letter in the text box on the screen.

4. Language: Switches among sound modes (analogue TV), displays and changes audio/subtitle language and turns subtitles on or off (digital TV, where available)

5. Menu: Displays TV menu

6. Volume +/-

7. *Info: Displays information about on-screen content, shows hidden information (reveal - in TXT mode)*
8. *Directional buttons: Helps navigate menus, content etc. and displays the subpages in TXT mode when pressed Right or Left*
9. *OK: Confirms user selections, holds the page (in TXT mode), views Channels menu (DTV mode)*
10. *Back/Return: Returns to previous screen, previous menu, opens index page (in TXT mode)*
11. *Coloured Buttons: Follow the on-screen instructions for coloured button functions*
 12. *Rakuten TV: Launches the Rakuten TV application*
 13. *Rewind: Moves frames backwards in media such as movies*
 14. *Record: Records programmes*
 15. *Pause: Pauses the media being played, starts timeshift recording*
 16. *Play: Starts to play selected media*
 17. *Stop: Stops the media being played*
 18. *Fast Forward: Moves frames forward in media such as movies*
 19. *Netflix: Launches the Netflix application*
20. *Freeview Play: Connects to the Freeview Play platform where you can access available catch-up TV services*
21. *Exit: Closes and exits from displayed menus or returns to previous screen*
 22. *Guide: Displays the electronic programme guide*
 23. *Programme +/-*
24. *Text: Displays teletext (where available), press again to superimpose the teletext over a normal broadcast picture (mix)*
25. *Mute: Completely turns off the volume of the TV*

Remote Control- 2 (optional)

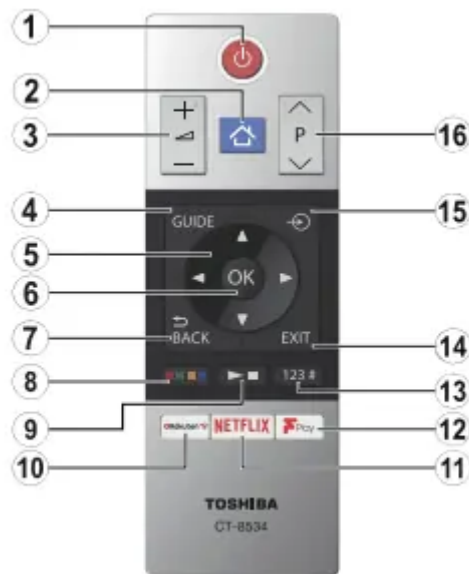

1. Standby: Switches On / Off the TV

2. Menu: Displays TV menu

3. Volume +/-

4. Guide: Displays the electronic programme guide

5. Directional buttons: Helps navigate menus, content etc. and displays the subpages in TXT mode when pressed Right or Left

6. OK: Confirms user selections, holds the page (in TXT mode), views Channels menu (DTV mode)

7. Back/Return: Returns to previous screen, previous menu, opens index page (in TXT mode)

8. Coloured Buttons Select the coloured button you want to use from the dialogue box and press OK. Follow the on-screen instructions for coloured button functions

9. Media Playback, Record (if available) and Language Buttons

Select the button you want to use from the dialogue box and press OK Use the media buttons to control the playback of the media. Control elements to play, pause, stop, rewind and fast forward the media will be available. Select the REC button and press OK to record a programme or select the Pause(II) button and press OK to start timeshift recording Select the LANG. button and press OK to switch among sound modes (analogue TV), display and change audio/subtitle language and turn subtitles on or off (digital TV, where available)

10. Rakuten TV: Launches the Rakuten TV application

11. Netflix: Launches the Netflix application

12. Freeview Play: Connects to the Freeview Play platform where you can access available catch-up TV services

13. Numeric, Text and CEC Buttons

Select the button you want to use from the dialogue box and press OK Use the numeric buttons to switch the channel, enter a number or a letter in the text box on the screen. Select the TEXT button and press OK to display teletext (where available). Press again to superimpose the teletext over a normal broadcast picture (mix) Select the CEC button and press OK to terminate the function that enables you to control the connected CEC device with the TV remote.

14. Exit: Closes and exits from displayed menus or returns to previous screen

15. Source: Shows available broadcast and content sources



























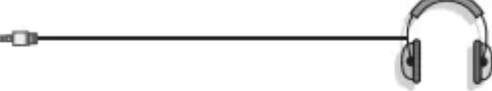



16. Programme +/-

Inserting the Batteries into the Remote

Remove the back cover to reveal the battery compartment. Insert two size AAA batteries. Make sure the (+) and (-) signs match (observe correct polarity). Do not mix old and new batteries. Replace only with same or equivalent type. Place the cover back on.



Connections

Connector	Type	Cables	Device
	VGA Connection (back)		
AUDIO IN 	PC/YPbPr Audio Connection (back)	 YPbPr/PC Audio Cable	
	HDMI Connection (side&back)		
SPDIF 	SPDIF (Optical Out) Connection (back)		
BACK AV 	Back AV (Audio/Video) Connection (back)	 Audio Video Cable	
HEADPHONE 	Headphone Connection (side)		
YPBPR 	YPbPr Video Connection (back)	 PC to YPbPr Connection Cable	
	USB Connection (side)		
	CI Connection (side)		
LAN 	Ethernet Connection (back)	 LAN / Ethernet Cable	

See the illustrations on the left side. You can use YPbPr to VGA cable to enable YPbPr signal via VGA input. You cannot use VGA and YPbPr at the same time. To enable PC/YPbPr audio, you will need to use the back audio inputs with a YPbPr/PC audio cable for audio connection. When using the wall mounting kit (available from a third party in the market, if not supplied), we recommend that you plug all your cables into the back of the TV before mounting on the wall. Insert or remove the CI module only when the TV is SWITCHED OFF. You should refer to the module instruction manual for details of the settings. The/ Each USB input of your TV supports devices up to 500mA. Connecting devices that have current value above 500mA may damage your TV. When connecting equipment using a HDMI cable to your TV, to guarantee sufficient immunity against parasitic

frequency radiation and trouble-free transmission of high definition signals, such as 4K content, you have to use a high speed shielded (high grade) HDMI cable with ferrites.



If you want to connect a device to the TV, make sure that both the TV and the device are turned off before making any connection. After the connection is done, you can turn on the units and use them.

Switching On/Off

To Switch the TV On

Connect the power cord to a power source such as a wall socket (220-240V AC, 50 Hz).

To switch on the TV from standby mode either:

- Press the Standby button, Programme +/- or a numeric button on the remote control.
- Press the middle of the side function switch on the TV in.

To Switch the TV Off

Press the Standby button on the remote control or press the middle of the side function switch on the TV in and hold it down for a few seconds, the TV will switch into standby mode.

To power down the TV completely, unplug the power cord from the mains socket.

Note: When the TV is switched into standby mode, the standby LED can blink to indicate that features such as Standby Search, Over Air Download or Timer is active. The LED can also blink when you switch on the TV from standby mode.

First Time Installation

When turned on for the first time, the language selection screen is displayed. Select the desired language and press OK. In the following steps of the installation guide, set your preferences using the directional buttons and OK button.

On the second screen set your country preference. Depending on the Country selection you may be asked to set and confirm a PIN at this point. The selected PIN cannot be 0000. You have to enter it if you are asked to enter a PIN for any menu operation later.

You can activate Store Mode option in the next step. This option will configure your TV's settings for store environment and depending on the TV model being used, the supported features of it may be displayed on the side of the screen as an info banner. This option is intended only for store use. It is recommended to select Home Mode for home use. This option will be available in Settings>System>More menu and can be turned off/on later. Make your selection and press OK to continue.

Depending on the model of your TV and the country selection Privacy Settings menu may appear at this point. Using this menu you can set your privacy privileges. Highlight a feature and use Left

and Right directional buttons to enable or disable. Read the related explanations displayed on the screen for each highlighted feature before making any changes. You can use Programme +/- buttons to scroll up and down to read the entire text. You will be able to change your preferences at any time later from the Settings>System>Privacy Settings menu. If the Internet Connection option is disabled Network/Internet Settings screen will be skipped and not displayed.

Highlight Next and press OK button on the remote control to continue and the Network/Internet Settings menu will be displayed. Please refer to Connectivity section to configure a wired or a wireless connection. If you want your TV to consume less power in standby mode, you can disable the Wake On option by setting it as Off. After the settings are completed highlight Next and press OK button to continue.

On the next screen you need to agree to the terms and conditions of Freeview Play to make use of the related services. Scroll the page to read the entire text using the up/down directional buttons or Programme +/- buttons. Highlight Yes and press OK on the remote to confirm and proceed. Highlight No and press OK to proceed without confirmation. For further requirements for Freeview Play services refer to the Freeview Play Platform section.

On next screen you can set broadcast types to be searched, set your encrypted channel searching and time zone (depending on the country selection) preferences. Additionally you can set a broadcast type as your favourite one. Priority will be given to the selected broadcast type during the search process and the channels of it will be listed on the top of the channel list. When finished, highlight Next and press OK to continue.

About Selecting Broadcast Type

To turn a search option for a broadcast type highlight it and press OK. The checkbox next to the selected option will be checked. To turn the search option off clear the checkbox by pressing OK after moving the focus on the desired broadcast type option.

Digital Aerial: If D. Aerial broadcast search option is turned on, the TV will search for digital terrestrial broadcasts after other initial settings are completed.

Digital Cable: If D. Cable broadcast search option is turned on, the TV will search for digital cable broadcasts after other initial settings are completed. A message will be displayed before starting to search asking if you want to perform cable network search. If you select Yes and press OK you can select Network or set values such as Frequency, Network ID and Search Step on the next screen. If you select No and press OK you can set Start Frequency, Stop Frequency and Search Step on the next screen. When finished, highlight Next and press OK button to continue.

Note: Searching duration will change depending on the selected Search Step.

Satellite: If Satellite broadcast search option is turned on, the TV will search for digital satellite broadcasts after other initial settings are completed. Before satellite search is performed some settings should be made. Antenna Type menu will be displayed first. You can select Antenna Type as Direct, Single Satellite Cable or DiSEqC switch by using Left or Right buttons. After selecting your antenna type press OK to see the options to proceed. Continue, Transponder list and

Configure LNB options will be available. You can change the transponder and LNB settings using the related menu options.

- **Direct:** If you have a single receiver and a direct satellite dish, select this antenna type. Press OK to continue. Select an available satellite on the next screen and press OK to scan for services.
- **Single Satellite Cable:** If you have multiple receivers and a single satellite cable system, select this antenna type. Press OK to continue. Configure settings by following instructions on the next screen. Press OK to scan for services.
- **DiSEqC switch:** If you have multiple satellite dishes and a DiSEqC switch, select this antenna type. Press OK to continue. You can set four DiSEqC options (if available) on the next screen. Press OK button to scan the first satellite in the list.

Analogue: If Analogue broadcast search option is turned on, the TV will search for analogue broadcasts after other initial settings are completed.

After the initial settings are completed TV will start to search for available broadcasts of the selected broadcast types.

While the search continues current scan results will be displayed at the bottom of the screen. After all the available stations are stored, Channels menu will be displayed. You can edit the channel list according to your preferences using the Edit tab options or press the Menu button to quit and watch TV.

While the search continues a message may appear, asking whether you want to sort channels according to the LCN(*). Select Yes and press OK to confirm.

() LCN is the Logical Channel Number system that organizes available broadcasts in accordance with a recognizable channel number sequence (if available).*

Note: Do not turn off the TV while initializing first time installation. Note that, some options may not be available depending on the country selection

Media Playback via USB Input

You can connect 2.5" and 3.5" inch (HDD with external power supply) external hard disk drives or USB memory stick to your TV by using the USB inputs of the TV

IMPORTANT! Back up the files on your storage devices before connecting them to the TV. Manufacturer will not be responsible for any file damage or data loss. Certain types of USB devices (e.g. MP3 Players) or USB hard disk drives/memory sticks may not be compatible with this TV. The TV supports FAT32 and NTFS disk formatting.

Note : *Recording will not be available with NTFS formatted disks. While formatting USB hard drives which have more than 1TB (Tera Byte) storage space you may experience some problems in the formatting process.*

Wait a little while before each plugging and unplugging as the player may still be reading files. Failure to do so may cause physical damage to the USB player and the USB device itself. Do not pull out your drive while playing a file.

You can use USB hubs with your TV's USB inputs. External power supplied USB hubs are recommended in such a case.

It is recommended to use the TV's USB input(s) directly, if you are going to connect a USB hard disk.

Note: *When viewing image files the Media Browser menu can only display 1000 image files stored on the connected USB device.*

USB Recording

Recording a Programme

IMPORTANT: When using a new USB hard disk drive, it is recommended that you first format the disk using your TV's Format Disk option in the TV>Recordings>Settings menu.

To record a programme, you should first connect a USB disk to your TV while the TV is switched off. You should then switch on the TV to enable the recording feature. To use recording your USB drive should have 2 GB free space and be USB 2.0 compatible. If the USB drive is not compatible an error message will be displayed. To record long duration programmes such as movies, it is recommended to use USB Hard disk drives (HDD's). Recorded programmes are saved into the connected USB disk. If desired, you can store/copy recordings onto a computer; however, these files will not be available to be played on a computer. You can play the recordings only via your TV.

Lip Sync delay may occur during the timeshifting. Radio record is supported. The TV can record programmes up to ten hours.

Recorded programmes are split into 4GB partitions. If the writing speed of the connected USB disk is not sufficient, the recording may fail and the timeshifting feature may not be available.

It is recommended to use USB hard disk drives for recording HD programmes.

Do not pull out the USB/HDD during a recording. This may harm the connected USB/HDD.

If the AC cord is unplugged while there is an active USB-recording timer setting, it will be cancelled. Multipartition support is available. A maximum of two different partitions are supported. The first partition of the USB disk is used for USB Recording ready features. It also must be formatted as the primary partition to be used for the USB Recording ready features.

Some stream packets may not be recorded because of signal problems, as a result sometimes videos may freeze during playback. Record, Play, Pause, Display (for playlist dialogue) keys can not be used when teletext is on. If a recording starts from timer when teletext is on, teletext is automatically turned off. Also teletext usage is disabled when there is an ongoing recording or playback.

Timeshift Recording

Press Pause button while watching a broadcast to activate timeshifting mode. In timeshifting mode, the programme is paused and simultaneously recorded to the connected USB disk. Press Play button again to resume the paused programme from where you stopped.

Press the Stop button to stop timeshift recording and return to the live broadcast.

Timeshift cannot be used while in radio mode. You can use the timeshift rewind feature after resuming normal playback or fast forward option.

Instant Recording

Press Record button to start recording an event instantly while watching a programme. You can press Record button on the remote control again to record the next event after selecting the next programme from within the electronic programme guide. Press Stop button to cancel instant recording.

You can not switch broadcasts or view the media browser during the recording mode. While recording a programme or during the timeshifting, a warning message appears on the screen if your USB device speed is not sufficient.

Watching Recorded Programmes

Select Recordings from the TV menu. Select a recorded item from the list (if previously recorded). Press the OK button to view the Options menu. Select an option then press OK button.

Note: Viewing main menu and menu items will not be available during the playback.

Press the Stop button to stop a playback and return to the Recordings.

Slow Forward

If you press Pause button while watching recorded programmes, the slow forward feature will be available. You can use Fast Forward button to slow forward. Pressing Fast Forward button consecutively will change slow forwarding speed.

Recording Configuration

Select the Settings tab in the TV>Recordings menu to configure the recording settings and press OK.

Format Disk: You can use the Format Disk option for formatting the connected USB disk. Your PIN will be required to use the Format Disk feature.

Note: Default PIN could have been set to 0000 or 1234. If you have defined the PIN(is requested depending on the country selection) during the First Time Installation use the PIN that you have defined.

IMPORTANT: Formatting your USB drive will erase ALL the data on it and it's file system will be converted to FAT32. In most cases operation errors will be fixed after a format but you will lose ALL your data.





If “USB disk writing speed too slow to record” message is displayed on the screen while starting a recording, try restarting the recording. If you still get the same error, it is possible that your USB disk does not meet the speed requirements. Try connecting another USB disk.

Media Browser

You can play back music and movie files and display photo files stored on a USB storage device by connecting it to your TV. Connect a USB storage device to one of the USB inputs located on the side of the TV.

After connecting a USB storage device to your TV Media Browser menu will be displayed on the screen. You can access the content of the connected USB device any time later from the Sources menu. Select the related USB input option from this menu and press OK. Then select the file of your choice and press OK to display or play it back.

You can set your Media Browser preferences by using the Settings menu. Settings menu can be accessed via the information bar which is displayed on the bottom of the screen when pressed the Info button while playing back a video file or displaying a picture file. Press the Info button, highlight the gear wheel symbol positioned on the right side of the information bar and press OK. Picture Settings, Sound Settings, Media Browser Settings and Options menus will be available. The contents of these menus may change according to the type of the currently open media file. Only Sound Settings menu will be available while playing back audio files.

Loop/Shuffle Mode Operation	
Start playback and activate 	All files in the list will be continuously played in original order
Start playback and activate 	The same file will be played continuously (repeat)
Start playback and activate 	All files in the list will be played once in random order
Start playback and activate  	All files in the list will be continuously played in the same random order

To use the functions on the information bar highlight the symbol of the function and press OK. To change the status of a function highlight the symbol of the function and press OK as much as needed. If the symbol is marked with a red cross, that means it is deactivated.

Custom Boot Up Logo

You can personalize your TV and see your favourite image or photo on the screen each time your TV boots up. To do this, copy your favourite image files into a USB disk and open them in the Media Browser. Select USB input from the Sources menu and press OK. When you have chosen the desired image, highlight it and press OK to view it in full screen. Press the Info button, highlight the gear wheel symbol on the information bar and press OK. Select Options and press OK to enter. Set Boot Logo option will be available. Highlight it and press OK again to choose the image as

custom boot logo. A confirmation message will be displayed. Select Yes and press OK again. If the image is suitable(*) you will see it on the screen during the TV's next boot up

Note: If you perform a First Time Installation the TV will return to using the default logo, if any.

(*) Images must have an aspect ratio between 4:3 to 16:9 and they must be in .jpeg, .jpg or .jpe file formats. The image cannot be set as boot logo, which's resolution doesn't appear on the info banner.

Settings Menu Contents

Using the Channel List

The TV sorts all stored stations in the channel list. You can edit this channel list, set favourites or set active stations to be listed by using the Channels menu options. Press the OK button to open the channel list. You can filter the listed channels or make advanced changes in the current list using the Filter and Edit tab options. Highlight the tab you want and press OK to see available options.

Managing the Favourite Lists

You can create four different lists of your favourite channels. Enter the TV>Channels menu or press the OK button in order to open the Channels menu. Highlight the Edit tab and press OK to see the editing options and select the Tag/Untag channel option. Select the desired channel on the list by pressing the OK button while the channel is highlighted. You can make multiple choices. You can also use the Tag/ Untag all option to select all channels on the list. Then press Back/Return button to return to the Edit menu options. Select Add/Remove Favourites option and press the OK button again. Favourite channel list options will be displayed. Set the desired list option to On. The selected channel/s will be added to the list. In order to remove a channel or channels from a favourite list follow the same steps and set the desired list option to Off.

You can use the filtering function in the Channels menu to filter the channels in the channel list permanently according to your preferences. For instance, using the options of the Filter tab, you can set one of your four favourite lists to be displayed every time the channel list is opened.

Configuring Parental Settings

The Parental menu options can be used to prohibit users from viewing of certain programmes, channels and using of menus. These settings are located in the Settings> System>Parental menu.

To display parental lock menu options, a PIN should be entered. After coding the correct PIN, Parental menu will be displayed

Menu Lock: This setting enables or disables access to all menus or installation menus of the TV.

Guidance: This setting enables or disables access some of the MHEG applications. Disabled applications can be released by entering the right PIN.

Internet Lock: If this option is set to ON, the open browser application in the portal will be disabled. Set to OFF to release the application again.

Set PIN: Defines a new PIN number.

Default CICAM PIN: This option will appear as greyed out if no CI module is inserted into the CI slot of the TV. You can change the default PIN of the CI CAM using this option.

Note: *Default PIN could have been set to 0000 or 1234. If you have defined the PIN(is requested depending on the country selection) during the First Time Installation use the PIN that you have defined.*

Some options may not be available depending on the model and/or on the country selection in the First Time Installation.

Electronic Programme Guide

By means of electronic programme guide function of your TV you can browse the event schedule of the currently installed channels on your channel list. It depends on the related broadcast whether this feature is supported or not.

To access the programme guide, press the Guide button on your remote. You can also use the Guide option under TV menu.

There are 2 different types of schedule layouts available, Timeline Schedule and Now/Next. To switch between these layouts highlight the tab with the name of the alternative layout on the upper side of the screen and press OK.

Use the directional buttons to navigate through the programme guide. Use the Back/Return button to use the tab options on the upper side of the screen.

Timeline Schedule

In this layout option, all events of the listed channels will be displayed by timeline. You can use the directional buttons to scroll through the list of the events. Highlight an event and press OK to display event options menu.

Press Back/Return button to use available tab options. Highlight Filter tab and press OK to see the filtering options. To change the layout highlight Now/Next and press OK. You can use the Previous Day and Next Day options to display the events of the previous and next day.

Highlight Extras tab and press OK to access below options.

Highlight Genre: Displays Highlight Genre menu. Select a genre and press OK. The events in the programme guide matching the selected genre will be highlighted.

Guide Search: Displays searching options. Using these options, you can search the programme guide database in accordance with the selected criteria. Matching results will be listed.

Now: Displays current event of the highlighted channel. Zoom: Highlight and press OK to see events in a wider time interval.

Now/Next Schedule

In this layout option, only the current and next events of the listed channels will be displayed. You can use the directional buttons to scroll through the list of the events.

Press Back/Return button to use available tab options. Highlight Filter tab and press OK to see the filtering options. To change the layout highlight Timeline Schedule and press OK.

Event Options

Use the directional buttons to highlight an event and press OK button to display Options menu. The following options are available.

Select Channel: Using this option, you can switch to the selected channel in order to watch it. The programme guide will be closed.

More Info: Display detailed information on the selected event. Use up and down directional buttons to scroll through the text.

Set Timer on Event / Delete Timer on Event: Select Set Timer on Event option and press OK. You can set timers for future events. To cancel an already set timer, highlight that event and press the OK button. Then select Delete Timer on Event option. The timer will be cancelled.

Record / Delete Rec. Timer: Select the Record option and press the OK button. If the event is going to be broadcasted at a future time, it will be added to Timers list to be recorded. If the selected event is being broadcasted at the moment, recording will start immediately.

To cancel an already set record timer, highlight that event and press the OK button and select the option Delete Rec. Timer. The record timer will be cancelled.

IMPORTANT: Connect a USB disk to your TV while the TV is switched off. You should then switch on the TV to enable the recording feature.

Notes: *You cannot switch to any other channel while there is an active recording or timer on the current channel. It is not possible to set timer or record timer for two or more individual events at the same time interval.*

Integrated Catch-Up Services

You can enjoy Freeview Play catch-up TV services that work directly through the electronic programme guide. Whilst you are on a channel use the directional buttons to scroll back in time through the timelinebased guide. You will see contents from last few days. Available catch-up contents may change according to broadcasters and will be marked with a play icon. Highlight the content you want to play back and press the OK button.

Make sure that your TV is connected to your home network in order to use the catch-up services. For further information regarding this matter and other requirements for Freeview Play services refer to the Connectivity and Freeview Play Platform sections.

Troubleshooting & Tips

TV will not turn on

- Make sure the power cord is plugged in securely to a wall outlet. Press the Power button on the TV.

Poor picture

- Check if you have correctly tuned the TV.
- Low signal level can cause picture distortion. Please check antenna connections.
- Check if you have entered the correct channel frequency if you have performed manual tuning.

No picture

- TV is not receiving any signal. Make sure the correct source has been selected.
- Is the antenna connected properly?
- Is the antenna cable damaged?
- Are suitable plugs used to connect the antenna?
- If you are in doubt, consult your dealer.

No sound

- Check if the TV sound is muted. Press the Mute button or increase the volume to check.
- Sound is coming from only one speaker. Check the balance settings from Sound menu.

Remote control - no operation

- The batteries may be exhausted. Replace the batteries.
- The batteries maybe inserted incorrectly. Refer to the section “Inserting the Batteries into the Remote”.

No signal on an input source

- It is possible that no device is connected.
- Check the AV cables and connections from your device.
- Check the device is switched on.

Recording unavailable

To record a programme, you should first correctly connect a USB storage device to your TV, while the TV is switched off. You should then switch on the TV to enable the recording feature. If you cannot record, check the storage device is correctly formatted and there is sufficient space.

USB is too slow

If a “USB storage device writing speed too slow to record” message is displayed on the screen while starting a recording, try restarting the recording. If you still get the same error, it is possible that your USB storage device does not meet the speed requirements. Try using a different USB storage device.

Warning

This content is compiled from multiple sources and is provided for reference purposes only. It may not be complete or fully applicable to all situations. If you are unable to resolve your issue, please contact the product manufacturer or an authorized service provider for official support.

Document generated by [ManualsFile](#)

