

Connections and Setup

TV Buttons

If the batteries in your remote control are run down, you can use the buttons on your TV set. They have the following functions:

For models with below buttons on the set:

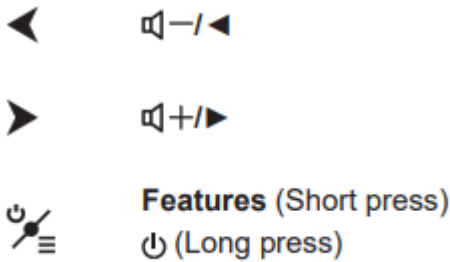

For models with below buttons on the set:

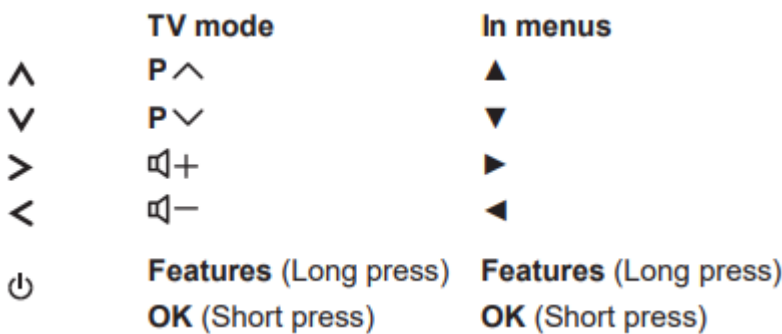

For models with only one button on the set:



Note: Figures and illustrations are provided for reference only and may vary depending on the model.

Initial Setup

The first time you switch the set on, the Welcome screen appears, which guides you through the initial setup process. Follow the on-screen instructions to finish the initial setup process such as selecting the language, connecting to the network, scanning channels, and more. During each step, either make a choice or skip the step. If you skip a step, you can perform the setup later from the settings menu.

Note: If the channel search retrieved only the analogue channels it could be caused by poor broadcasting and therefore is not covered by manufacturer warranty. Manufacturers cannot be held responsible for lack of or poor broadcasting in some areas.

Part 1, Google setup

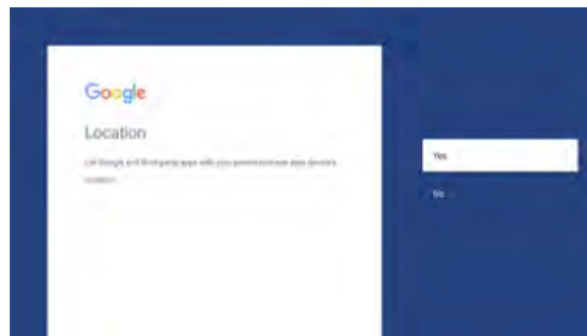
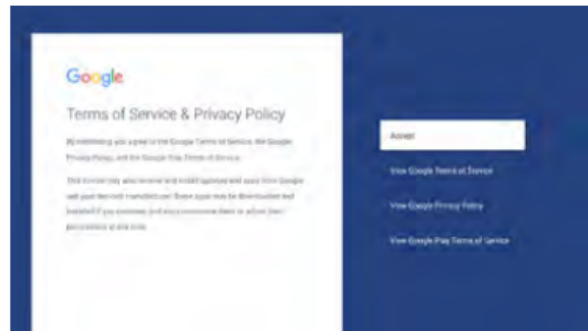
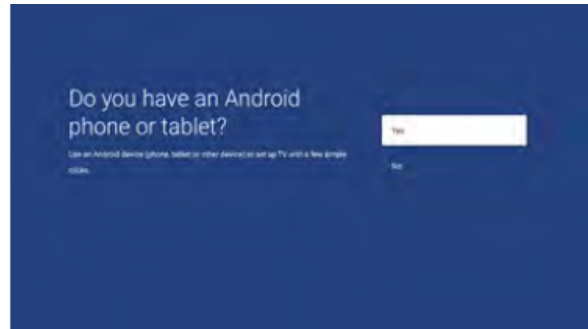
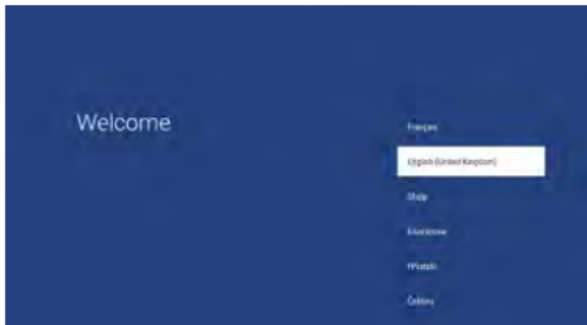

Part 2, TCL initial setup



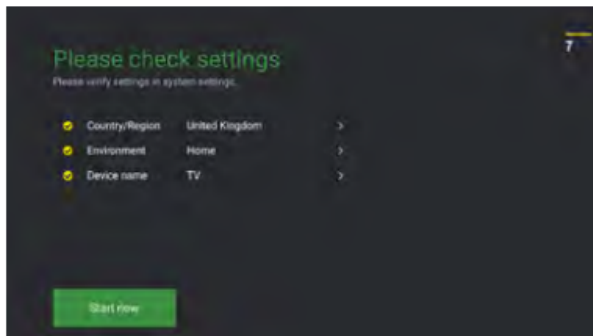
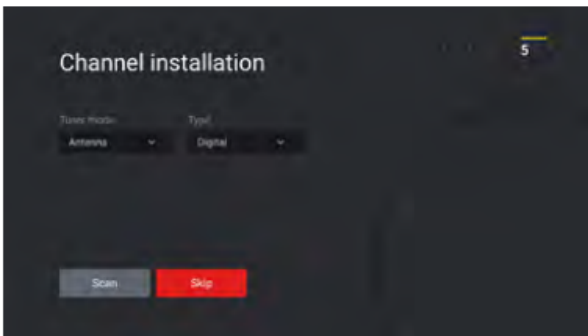
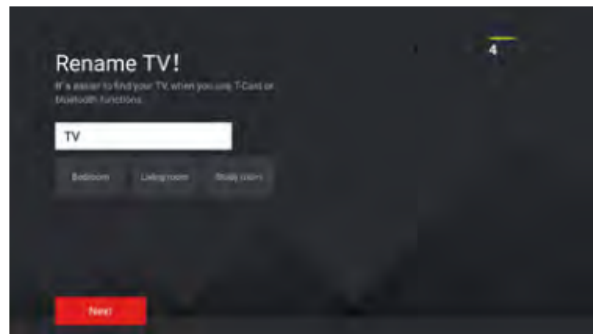
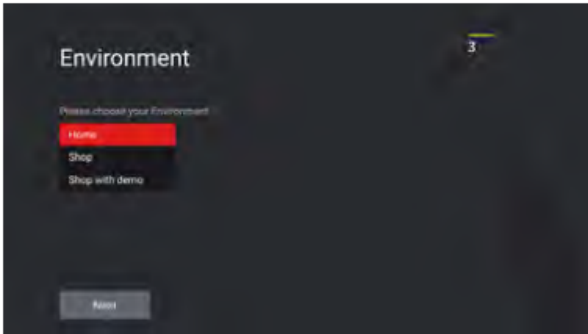
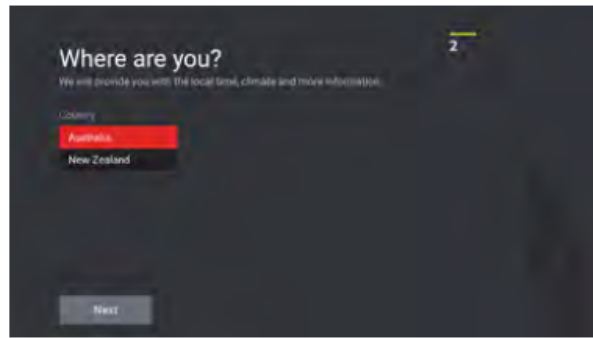
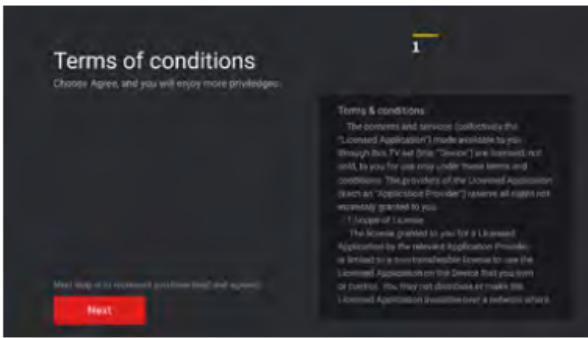

Sockets

Note: The location and names of the sockets on the TV may vary according to TV model, and not all sockets are available on all models.

USB 3.0 or USB2.0 or USB 2.0/SERVICE socket (input)

These sockets can be used to connect a USB device. Note: The number of USB sockets on the TV may vary according to TV model.

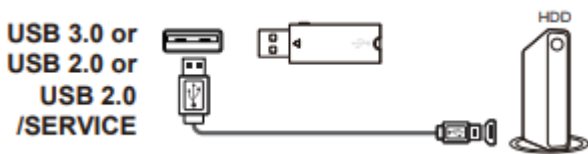

HDMI or HDMI(ARC) socket (input)

The HDMI (High-Definition Multimedia Interface) socket can be used to connect a Blu-ray player, PC with a compatible video card installed, certain DVD players or a high-definition compatible

digital satellite decoder. This socket provides an uncompressed digital connection that carries both video and audio data by way of an integrated mini-plug cable.

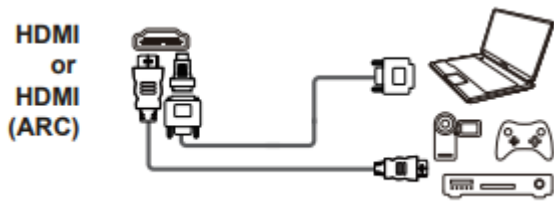

COMPONENT IN(YPBPR) socket (input)

These YPbPr sockets can be used to connect a device that has component video sockets, such as a DVD player. The component sockets can recognize if the device you're connecting to is Y Pb Pr compatible. The component sockets provide excellent picture quality because the video is separated into three independent parts.

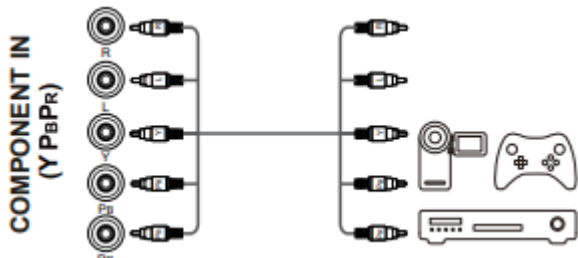

AV IN adapter socket

The AV IN adapter socket can be used to connect the attached AV adapter cable with VIDEO and AUDIO L & R IN sockets. The AV IN sockets can be used to connect a range of equipment, including video recorders, camcorders, decoders, satellite receivers, DVD players, or games consoles. The VIDEO IN socket provides composite video connection.

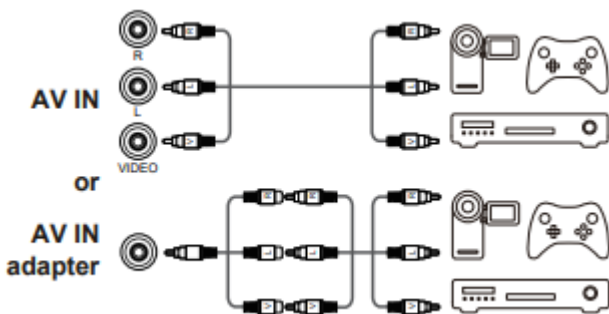

ANTENNA IN socket (input)

This socket can be used to connect an outside aerial.



LAN



RJ45 plug for connecting to external modem or network access equipment.



SPDIF socket (output)

The SPDIF socket can be used to connect a compatible digital audio receiver.



Headphone socket (output)

This socket can be used to connect headphones or stereo earphones.

Warning: Excessive sound pressure from earphones and headphones can cause hearing loss.





Remote Control Functions

Most of your television's functions are available via the menus that appear on the screen. The remote control supplied with your set can be used to navigate through the menus and to configure all the general settings.

Note: Figures and illustrations in this operation manual are provided for reference only and may differ from actual product appearance.



 To switch the sound off and back on.

 Standby / quit standby.



Numeric buttons To enter channel numbers or a digit.

 To access or exit T-Launcher.

LIST To display the channel list.

 To control the volume.

 To display programme information, if available.

 To display the Settings menu.

 To change channels.

 To access or exit the Smart TV homepage.

 To display the Option menu.

 Navigation direction buttons.

OK To confirm an entry or selection.

 To return to the previous menu or quit an App.

 To select input source.

EXIT To exit the Settings menu.

LANG To select an audio language available for selected digital TV programme.

GUIDE To toggle the Electronic Programme Guide on or off (only available for digital channels).

TEXT To toggle Teletext on or off.

SUBT. To select a subtitle language available for selected digital TV programme.

Colour buttons To select tasks or Teletext pages; to be used for HbbTV function.

 To start fast reverse.

 To pause playback.

 To start fast forward.

 To record programmes under DTV source.

 To start playback.

 To stop playback.

NETFLIX To access the NETFLIX application. (Not available for some models.)

Installing Batteries

1. Push to open the back cover as illustrated.
2. Insert two AAA batteries according to the polarities marked on the battery case.
3. Replace the back cover as illustrated.

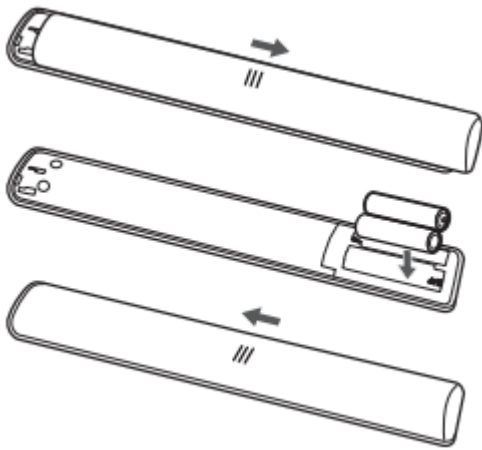

Exclusive Remote Control

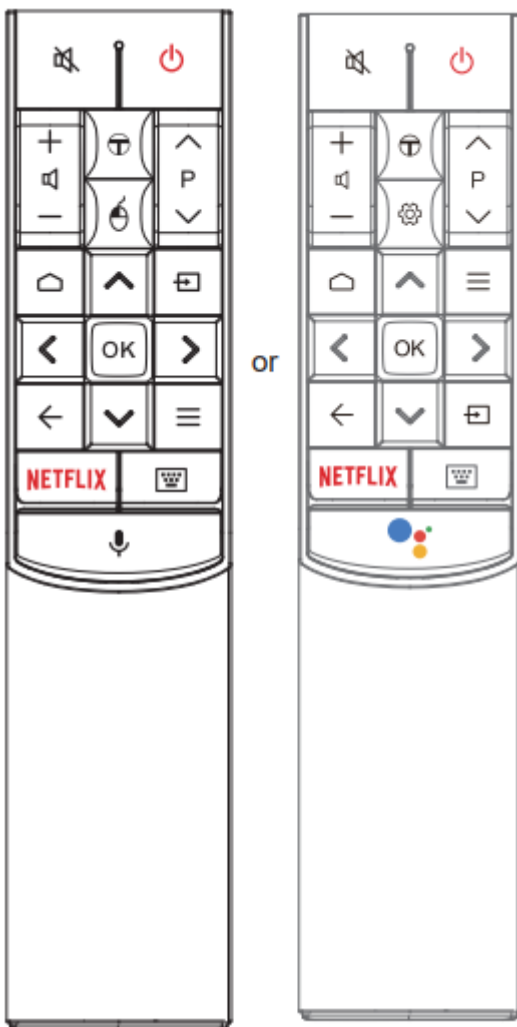



 To switch the sound off and back on.

 Standby / quit standby.

 To control the volume.

 To access or exit T-Launcher.

 To turn on the mouse function.

 To display the Settings menu.

 To change channels.

 To access or exit the Smart TV homepage.

 To select input source.

 Navigation direction buttons.

OK To confirm an entry or selection.

 To return to the previous menu or quit an App.



 To display the Option menu.



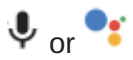

NETFLIX To access Netflix.

 To pop up the virtual remote control keyboard when available.

 To turn on the voice function. (Available only when the network connection is normal.)

How to use the remote control

When using  or  or  button for the first time, you will be prompted to pair the remote with the TV. Please follow the on-screen guide for pairing instructions.

a. Keep the remote control and TV in 1 meter, press **OK** and  button on the remote at the same time. You can use  or  or  button after activating successfully.

b. This voice search function or is only available for content search from certain apps.

c. Set languages in the TV **settings** to your local language or official language to enhance voice search successfully.

Installing batteries

1. Hold the bottom part of the remote control, use a plastic coin-shaped object to twist the switch to the “Open” location as illustrated.
2. Pull out the battery cover.
3. Insert two AAA batteries according to the polarities marked on the battery case.
4. Replace the battery cover and use a plastic coin-shaped object to twist the switch to the “Close” location.

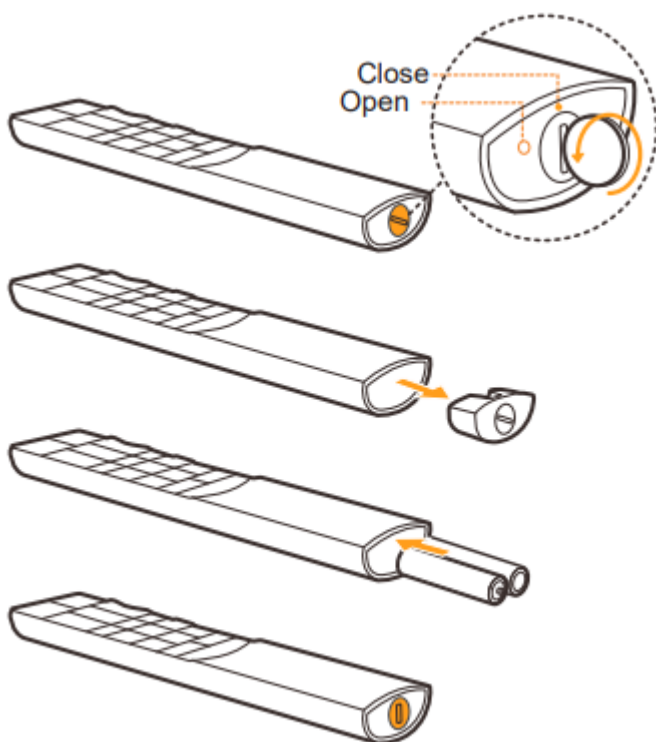

Network Connection

WARNING: Your TV will require an internet connection to operate all functions. Data usage charges may apply. Please refer to your Internet Service Provider (ISP) for additional information.

To access the internet, you must subscribe to high speed broadband internet service from your internet service provider.

Your TV can be connected to your home network in two ways:

- Wired, using the RJ45 (LAN) connector on the back panel.
- Wireless, using the internal wireless or external wireless USB adapter and your home wireless network.

Note: The following instructions are just the usual ways to connect your TV to the wired or wireless network. The connection method may be different depending on your actual network configuration. If you have any questions about your home network, please refer to your ISP(Internet Service Provider).

Connecting to a wired network

To connect to a wired network:

1. Ensure you have:

- An Ethernet cable long enough to reach your TV
- A router or modem with an available Ethernet port
- A high-speed internet connection

- An Ethernet (LAN) port on the back of the TV
2. Connect your Ethernet cable to the router and to the Ethernet port on the back of the TV.
 3. Use the Network Settings to configure the TV.

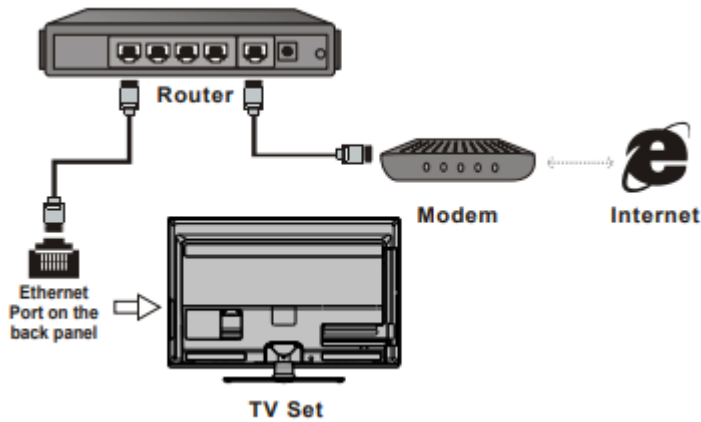

Connecting to a wireless network

To connect to a wireless network

1. Ensure you have:
 - A router broadcasting a high-speed wireless signal
 - A high-speed internet connection
2. Use the Network Settings to configure the TV.

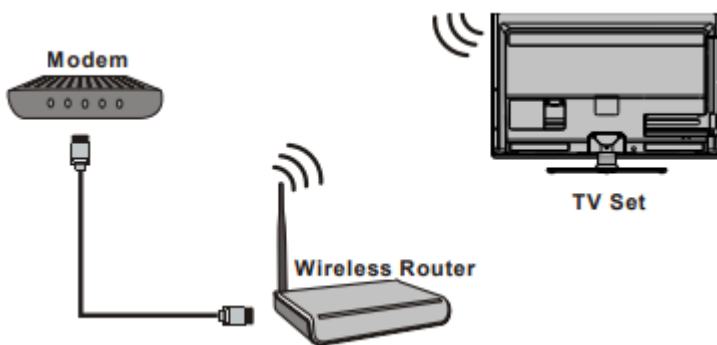



Network Settings

After you connect your home network to the TV, follow the steps below to configure the network settings of your TV.

Note: the wireless network connection won't work if your TV is already connected to a wired network.



Connecting to a wireless network

1. Press  on the remote control. The Smart TV homepage is displayed.
2. Press **▲/▼** to move to the **Settings** area, select **Settings** and press **OK** to enter.
3. Move to the **Device** area, select **Network** and press **OK** to enter. The **Network** menu is displayed.
4. Select **Wi-Fi** and press **OK** to enter.
5. Set **Wi-Fi** to **On**. All available wireless networks will be displayed.
6. Press **▲/▼** to highlight the name of your wireless network and press **OK**.
7. Using the on-screen keyboard and the remote, enter your network's password, then highlight **Enter** on the onscreen keyboard and press **OK**. Once connected, the wireless network will be saved. Next time when you connect to the same network, you do not have to re-enter the password.
8. Press  to close the menu and return to the Smart TV homepage.

Connecting to a wired network

1. From the **Network** menu, select **Ethernet** and press **OK** to enter.
2. Press **▲/▼** to select **Proxy settings** and press **OK**.
3. Select **MANUAL**, using the on-screen keyboard and the remote, enter your network's proxy information step by step.
4. Press **▲/▼** to select **IP settings** and press **OK**.
5. Select **DHCP** or **STATIC**. If you select **STATIC**, you must enter your network's IP address, gateway, network prefix length, DNS1, and DNS2 step by step.
6. Press  to close the menu and return to the Smart TV homepage.

Detecting your network status

1. From the **Network** menu, select **Network Detection** and press **OK** to enter.
2. The **Network Detection** screen displays the connection method of your network connection.
3. Press  to close the menu and return to the Smart TV homepage.

Switching on

Follow the instructions on this page on how to switch on your TV set and the remote control before going on to following pages describing how to use the channel set-up procedure.

1. Insert two AAA batteries in the remote control.

Precautions on using batteries:

- Only use the battery types specified.
- Make sure you use the correct polarity.
- Do not mix new and used batteries.
- Do not use rechargeable batteries.
- Do not expose batteries to excessive heat such as sunshine, fire or similar, throw them in a fire, recharge them or try to open them, as this could cause them to leak or explode.
- Remove the batteries from the remote control if you are not using it for a long period of time.
- Attention should be drawn to the environmental aspects of battery disposal.

2. Connect the power cable to a mains socket. (If the power cable is not connected to the television, please first connect the power cable to the television.) Your TV set should only be connected to an AC supply. It must not be connected to a DC supply. If the plug is detached from the cable, do not, under any circumstances, connect it to a mains socket, as there is a risk of electric shock.

Note: The figures are for representation only. The location of the power socket at the back of the television might differ depending on the model.

3. Connect the outside aerial or cable network to the Antenna input socket at the back of the TV set.

The aerial socket (75 OHM - VHF / UHF / cable) can be used for connecting an external aerial or other equipment fitted with a modulator (video recorder, satellite receiver, etc.). We recommend that you do not connect other equipment (video recorder, satellite receiver, etc.) to your TV set to begin with, so as not to complicate the set-up procedure with the additional steps involved. Connect them when you have finished setting up the channels.

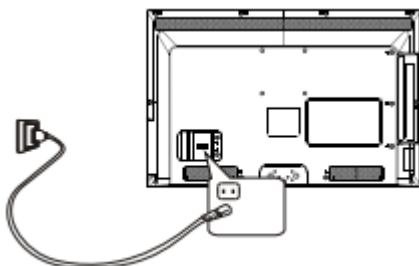

4. When powered on, the TV will be turned on directly or be in standby mode. If the TV set is in standby mode, press the standby button on the remote control or on the TV set to turn on the TV.

Note: The location and name of the power button on the TV may vary according to TV model.

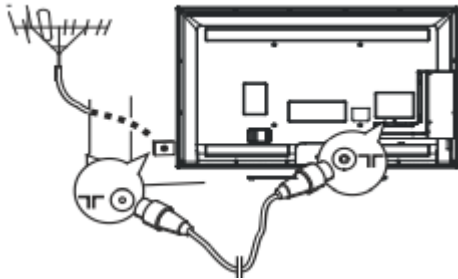

Switching off



To put the TV set into standby mode, press  on the remote control or on the TV, the TV set remains powered up, but with low energy consumption.





To switch off the TV set, disconnect the mains plug from the mains outlet.

Basic TV Operations



Accessing Channels





Using the numeric buttons: press the corresponding numeric buttons on the remote control to access the channels.

Using the  buttons: press the  buttons on the remote control or the corresponding buttons on the TV set to scroll through the channels.

Using the LIST button: press the **LIST** button on the remote control to display the channel list and press /// and **OK** to select channels.



Watching Connected Devices

Press  on the remote control to display the source list. Press / to select **TV** or other input sources and press **OK** to confirm.

You can also press  on the remote control to display the homepage, press / to move to the **Sources** area, then press / and **OK** to select the input source.

Adjusting Volume

Volume control: press the  buttons on the remote control or the corresponding buttons on the TV set to increase or decrease the volume.

Sound mute: press the  button to temporarily mute the sound. Press this button again or the  button to restore the sound.











Accessing Smart TV Homepage

Allows you to enjoy Internet Applications (Apps) and specially adapted Internet websites, and perform system settings for your TV. You can make controlling with the TV remote control.



WARNING:

- Configure the network settings before using Smart TV applications.
- Slow responses and/or interruptions may occur, depending on your network conditions.
- If you experience a problem using an application, please contact the content provider.
- According to circumstances of the content provider, an application's updates or the application itself may be discontinued.
- Depending on your country's regulations, some applications may have limited service or not be supported.
- Changes in application content may be made without prior notice by the service provider.





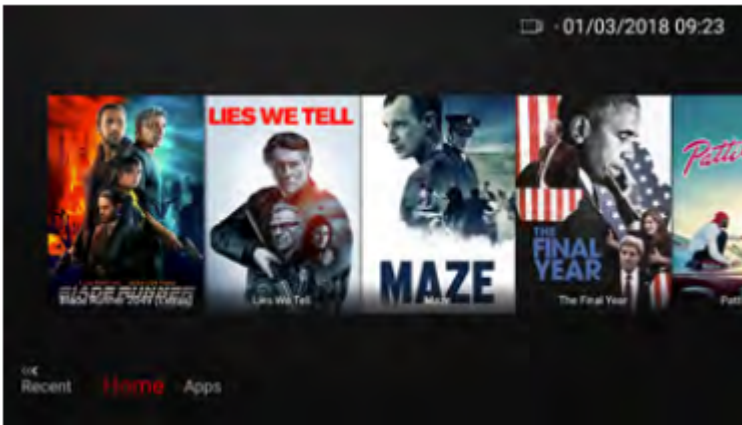

1. Press  on the remote control to display the Smart TV homepage.
2. Press  /  /  /  and **OK** to enter the desired Apps, functions or settings.
3. Press  to return to the homepage.
4. To exit the homepage, use  /  /  /  to move to the source you'd like to choose, then press **OK** to enter.

Note: Since the connection with Internet takes time, it's recommended that you wait a few minutes to use the Smart TV feature after activation of TV from standby.

Accessing T-Launcher

Allows you to enjoy Internet Applications (Apps).



1. Press  on the remote control to display the T-Launcher.
2. Press  /  /  /  and **OK** to enter the desired Apps.
3. Press  to return to the launcher.
4. Press  again to exit the T-Launcher.

Using Google Settings

Allows you to not only adjust device settings, such as network, inputs, Google Cast and apps, etc., but also set preferences.



1. Press  on the remote control to display the Smart TV homepage.

2. Press ▲/▼/◀/▶ to select **Settings** and press **OK** to enter the Google settings.
3. Press ▲/▼ to choose the items and press **OK** to enter.
4. Press ← to return to previous interface.
5. Press **EXIT** to close the menu.

Using Instant Power On

It enables you to turn on your TV within 5 seconds from standby mode.



1. Press  on the remote control to display the homepage, Press ▲/▼/◀/▶ to select **Settings > Device > Power > Instant power on** and press **OK**.
2. Press ▲/▼ to select **On** and press **OK** to confirm.
3. Press ← to return to the homepage.

Note: This function increases standby power consumption.

Using TV Settings menu

Allows you to adjust TV settings, such as picture and sound.



1. Press  on the remote control to display the Settings menu.
2. Press ▲/▼ to select the desired item, then press **OK/▶** to enter the corresponding submenu.
3. In submenus, press ▲/▼ to select menu options, then press **OK/▶** to enter the option list, the adjustment interface, or the corresponding submenu.
4. Press ← to return to the previous menu.
5. Press **EXIT** or  to close the menu.

Note: You can also press  on the remote control, select **Settings** (if available) and press **OK** to enter the Settings menu. Some options may not be available for certain signal sources.

Other Information

Problems & Solutions

Note: Problems & solutions 1 to 2 are for the TV models which have network functions, so users of non-connected TV models can disregard them.

1. Fail to link to the network.

- Check if your TV is connected with the network;
- Reboot your TV; - Consult your internet service provider, to confirm if access of your router is supported. Refer to the operation manual of your router.
- Make sure your TV is connected to a router, and make sure your router is powered on. Check that your router/modem has an internet connection, and that your Ethernet cables/wireless connection is OK. Test your connection with a computer to make sure it is OK. Should the problem persist, contact customer service.

2. The video could not be played smoothly.

- Videos from your USB flash drive --- It may result from data transmission, or its code flow is far beyond the supported formats of this TV set.
- Videos downloaded from internet, or online videos.
 - a. It may be caused by the lower bandwidth of your network. A high network speed is required to handle online videos.
 - b. Peak internet usage times may affect the bandwidth.
 - c. Check if any other computers on the same network are also operating, as they may be using up bandwidth. Especially if they are downloading or playing online videos.
 - d. The video may not be smooth itself, it is not the problem of your TV or network.

3. When two mobile hard disks are connected with the TV at the same time, they will not be recognized some times.

- All mobile hard disks consume a lot of power, which may result in power supply problems. We recommend inserting only one hard disk, or a low power consumption mobile hard disk.

4. The video from a mobile hard disk (USB) is playing with no sound.

- The audio format of the video in your mobile hard disk is not supported by the TV player.

5. Some videos fail to play.

- The formats of the videos may not be supported by the TV, especially videos shot by certain kinds of cameras, generally with their private protocol of formats, which are not compatible with your TV.

6. Video stops playing midway.

- Mistakes may occur when videos are copied or compressed, so they may automatically stop playing during playback.

7. What should I pay attention to, when I do SW updating

- No power cuts when SW updating;
- Avoid any operations with your remote control when SW updating;
- Depending on your internet connection speed, the software updating process may take some time.

8. There are no distinct changes of TV interface after SW updating.

- Under certain conditions, SW updating may not only update or add new functions but also improve the performance of the TV set, without distinct changes to the user interface. Also, there may be no changes to the user interface at all.

9. Voice search does not work.

- Check if your remote control has been successfully paired with your TV.
- Check if the language setting is correct.
- Check if Google server is available and stable.

Troubleshooting

Most problems you encounter with your TV can be corrected by consulting the following troubleshooting list.

No picture, no sound

1. Check if the fuse or circuit breaker is working.
2. Plug another electrical device into the outlet to make sure it is working or turned on.
3. Power plug is in a bad contact with the outlet.
4. Check the signal source.

No colour

1. Change the colour system.
2. Adjust the saturation.
3. Try another channel. Black-white programme may be received.

Remote control does not work

1. Change the batteries.
2. Batteries are not installed correctly.
3. Main power is not connected.

No picture, normal sound

1. Adjust the brightness and contrast.
2. Broadcasting failure may happen.

Normal picture, no sound

1. Press the VOLUME UP button to increase volume.
2. Volume is set to mute, press the Mute button to restore sound.
3. Change the sound system.
4. Broadcasting failure may happen.

Unorderly ripples on the picture

It is usually caused by local interference, such as cars, daylight lamps and hair driers. Adjust the antenna to minimize the interference.

Snowy dots and interference

If the antenna is located in the fringe area of a television signal where the signal is weak, the picture may be marred by dots. When the signal is extremely weak, it may be necessary to install a special antenna to improve the reception.

1. Adjust the position and orientation of the indoor/ outdoor antenna.
2. Check the connection of antenna.
3. Fine tune the channel.
4. Try another channel. Broadcasting failure may happen.

Ignition

Black spots or horizontal streaks appear, or the picture flutters or drifts. This is usually caused by interference from car ignition system, neon lamps, electric drills, or other electrical appliance.

Ghost

Ghosts are caused by the television signal following two paths. One is the direct path, the other is reflected from tall buildings, hills, or other objects. Changing the direction or position of the antenna may improve the reception.

Radio frequency interference

This interference produces moving ripples or diagonal streaks, and in some case, loss of contrast in the picture. Find out and remove the radio interference source.

*To bring you better visual experience, please remove all labels, if any, from TV front panel and screen before use.

*Figures and illustrations in this User Manual are provided for reference only and may differ from actual product appearance. Product design and specifications may be changed without notice.

Warning

This content is compiled from multiple sources and is provided for reference purposes only. It may not be complete or fully applicable to all situations. If you are unable to resolve your issue, please contact the product manufacturer or an authorized service provider for official support.

Document generated by [ManualsFile](#)