

Setting up your French Door Refrigerator

GETTING READY TO INSTALL THE REFRIGERATOR

Congratulations on your purchase of this Samsung French Door Refrigerator. We hope you enjoy the state-of-art features and efficiencies that this new appliance offers.

Selecting the best location for the refrigerator

Choose:

- A location with easy access to a water supply.
- A location without direct exposure to sunlight.
- A location with a level floor.
- A location with enough space for the refrigerator doors to open easily.
- A location that allows sufficient space to the right, left, back and top for air circulation. If the refrigerator does not have enough space, it can cause the bad influence to refrigeration efficiency and power consumption.
- A location that allows you to move the refrigerator easily if it needs maintenance or service.
- Do not install the refrigerator where the temperature will go below 10 °C.
- Do not locate the refrigerator where it may become wet

If the refrigerator does not have enough space, the internal cooling system may not work properly. If your refrigerator has an ice maker, allow extra space at the back for the water line connections. When you install the refrigerator next to a fixed wall, you need a minimum clearance of 95 mm between the refrigerator and wall to allow the door to swing open.

Important : Make sure that you can easily move your refrigerator to its final location by measuring doorways (both width and height), thresholds, ceilings, stairways, etc.

The following chart details the exact height and depth of this Samsung French Door Refrigerator.

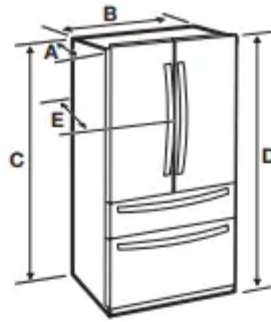

Depth "A"	726 mm
Width "B"	908 mm
Height "C"	1749 mm
Overall Height "D"	1777 mm
Depth "E"	788 mm

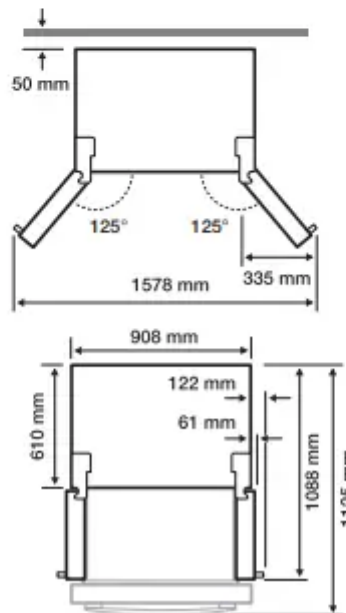

When moving your refrigerator

To prevent floor damage, be sure the front adjusting legs are in the up position (above the floor). Refer to 'Adjusting the Level' in the manual .

FLOORING

For proper installation, you must place this refrigerator on a level, hard surface that is the same height as the rest of the floor. This surface should be strong enough to support a fully loaded refrigerator.

To protect the finish of the flooring, cut a large section of the cardboard carton and place it under the refrigerator where you are working. When moving the



refrigerator, you need to pull and push it straight forwards or back. Do not wiggle it from side to side.

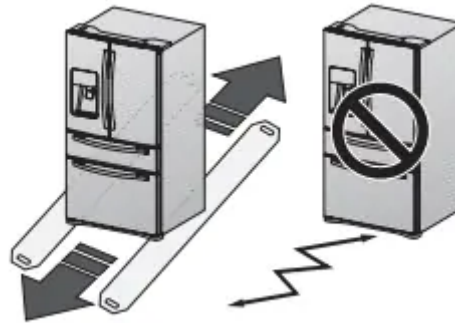

REMOVING THE REFRIGERATOR DOORS

For some installations you need to remove the fridge and freezer drawers so you can move the refrigerator to its final location. Do not remove the doors/drawer if you don't need to. If you do not need to remove the refrigerator doors, go to 'Leveling the Refrigerator'. If you need to remove the doors, continue below. Before removing the door/drawer, make sure you read the following items:

- Be careful not to drop, damage, or scratch the doors/drawers while removing them.
- Use care when you remove the doors/drawers. The doors are heavy and you could injure yourself.
- Reattach the doors/drawers properly to avoid:
 - Moisture from air leakage.
 - Uneven door alignment.
 - Wasting energy due to improper door seal.

Disassembling the refrigerator doors

WARNING: Be careful not to drop and scratch the doors while removing them.

Required Tools (Not provided)

You need the following tools to complete the installation of your refrigerator:

With the door opened

1. Remove the 3 screws holding down the TOP TABLE (1) and separate the connected wires.
2. Disconnect two connector (2) on the left side door. To remove the water coupler from the hinge, twist and pull it from the hinge, twist and pull it from the

hinge. Remove the water line (3) while pressing the marked part (4) of the water line coupler.

3. Pull and remove the hinge lever (5) . Remove the ground screw (6) attached to the upper left door hinges with a philips screwdriver (+). Remove the upper left and right door hinges (7).

4. Lift the door straight up to remove.

5. Remove the screw (8) attached to the lower left and right door hinges with a philips screwdriver (+). Remove the 2 hex head bolts (9) attached to the lower left and right door hinges with an allen wrench (). Remove the lower left and right door hinges (10)

REATTACHING THE WATER SUPPLY LINES

To reattach the fridge doors after you have moved the fridge to its final location, assemble the parts in reverse order.

1. The Water Line must be fully inserted into the center of the transparent coupler (Type A) or the Guide Lines (Type B) to prevent water leakage from the dispenser.

DISASSEMBLING THE FLEX DOOR

1. Take out the Flex Zone (1) by lifting it up. (1)

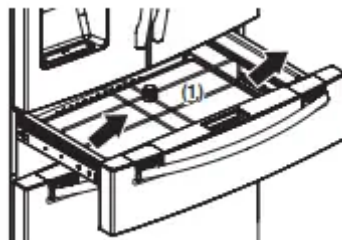

2. Take off the cover (2) w/harness with a flat blade screwdriver (-).

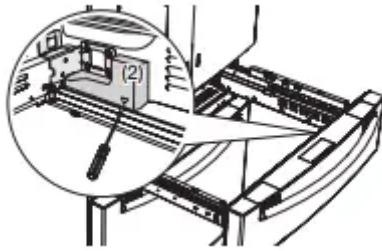

3. Press the locking tab and separate the Wire Connector.

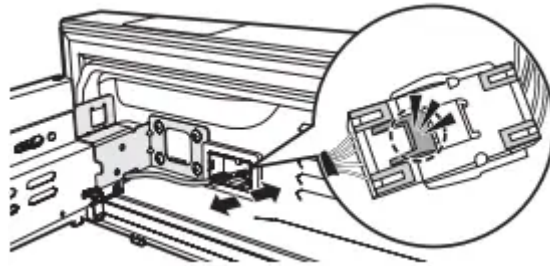

CAUTION When reassembling it, be sure to connect the wire harness. If it is not connected, the Flex Room does not work.

4. Remove 1 hex head bolt from each side with a socket wrench (10 mm).

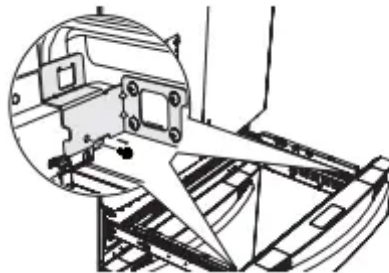

5. Lift up the Flex door from the rails.

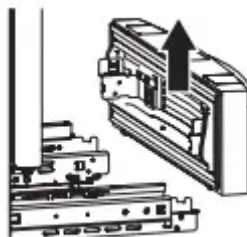

DISASSEMBLING THE FREEZER DOOR

1. Take out the upper drawer by lifting it up.
2. Remove the freeze room guard (1) by lifting the guard up.
3. Take out the lower basket (2) by lifting the basket up from the rail system.

4. Press the fixing hook of rail system

5. Holding the top of the Freezer Drawer, pull it out all the way and then remove it from the rail system.

CAUTION Putting too much food into the freezer drawers can prevent the freezer from closing completely and can cause frost build-up.

RE-ASSEMBLE THE FREEZER DRAWER

To reattach the drawer after you have moved the fridge to its final location, assemble the parts in reverse order.

LEVELING THE REFRIGERATOR

Make sure the refrigerator is level so that you can make final adjustments. Use a level to test if the refrigerator is level both side to side and back to front. If the refrigerator is not level, it will not be possible to get the doors perfectly even, which may cause moisture condensation and increased energy bills. Below is an example of how to level the refrigerator if the left side of the refrigerator is lower than the right side.

How to level the refrigerator

1. Open the freezer drawer and remove the lower basket.
2. Remove the Cover Leg to adjust the leg.
3. Insert a flat-blade screwdriver (-) into the notch on the left control lever, and turn it counter clockwise to level the refrigerator. (You turn the lever clockwise to lower the refrigerator and counterclockwise to raise it.)

CAUTION: Both control levers must be touching the floor to avoid possible personal injury or property damage because of tipping.

MAKING MINOR ADJUSTMENTS BETWEEN DOORS

Remember, a leveled refrigerator is necessary for getting the doors perfectly even. If you need help, review the previous section on leveling the refrigerator.

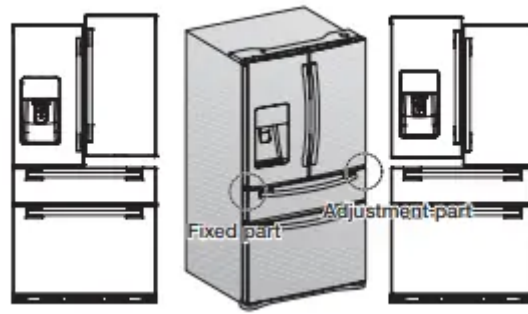

Snap ring

The height of a door or in door can be adjusted using the provided snap rings, which come in 4 different sizes (1 mm, 1.5 mm, 2 mm, and 2.5 mm).



To adjust the height of a door

Check the height difference between the doors, and then raise and hold the lower door.

- Insert the snap ring in the gap between the in door and the HINGE-SHAFT. (applicable models only)

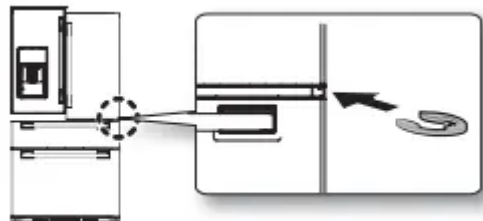

CAUTION

- Insert only one snap ring for this purpose. Two or more snap rings may slip out or make a rubbing noise.
- Keep the snap rings out of children's reach, and keep them for future use.
- Do not raise the door too much. The door can contact and damage the top cover.

MAKING MINOR ADJUSTMENTS BETWEEN OUT DOOR AND IN DOOR (APPLICABLE MODELS ONLY)

After raising the out door, insert the supplied SHIM HINGE MIDDLE in the gap between the OUT DOOR and the HINGE-SHAFT.

NOTE: Snap ring are enclosed with the refrigerator. The thickness of RING is 1 mm, 2 ea. Use the snap ring in case the handle does not move because the out door is lowered

INSTALLING THE WATER DISPENSER LINE

A water dispenser with a filter is one of the helpful features on your new refrigerator. To help promote better health, the water filter removes unwanted particles from your water. However, it does not sterilize or destroy microorganisms. You may need to purchase a water purifying system to do that. In order for the ice maker to operate properly, a water pressure of 138 ~ 862 kPa is required. Under normal conditions, a 170 cc (5.75 oz.) cup can be filled in about 10 seconds. If the refrigerator is installed in an area with low water pressure (below 138 kPa), you can install a booster pump to compensate for the low pressure. After you have connected the water line, make sure the water storage tank inside the refrigerator is properly filled. To do this, press the water dispenser lever until the water runs from the water outlet.

Parts for water line Installation

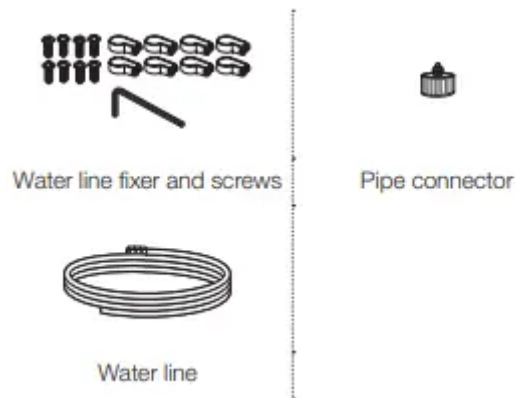

Connecting to the water supply line

1. First, shut off the main water supply line.
2. Locate the nearest cold, drinking water line.
3. Follow the Water line Installation Instructions in the installation kit

CAUTION The water line must be connected to the cold water pipe. If it is connected to the hot water pipe, it may cause the purifier to malfunction.

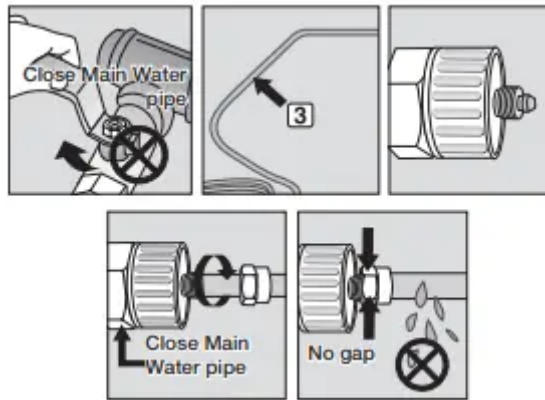

4. After connecting the water supply to the water filter, turn your main water supply back on and dispense about 3 L to clear and prime the water filter.

Connecting the water line to the refrigerator

1. Remove the cap from the water line on the unit and insert the compression nut of the water line into the water line on the unit.
2. Connect the water line on the unit with the water line in the kit.
3. Tighten the compression nut onto the compression fitting. There should be no gaps between (A, B & C)
4. Turn water on and check for any leakage.

Only connect the water line to a drinkable water source. If you have to repair or disassemble the water line, cut off 6.5 mm of the plastic tubing to make sure you get a snug, leak free connection.

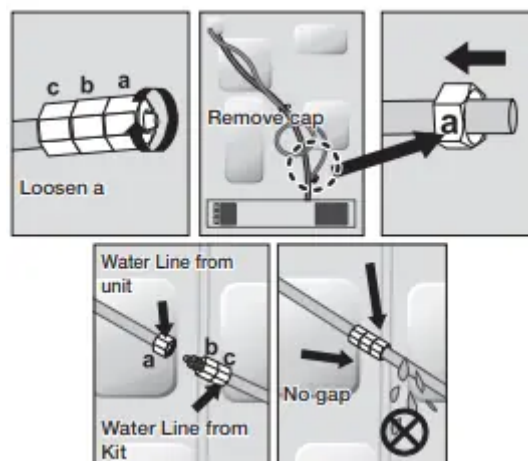

- Samsung Warranty does not cover WATER LINE INSTALLATION.
- It will be done at customer's charge unless the retail price includes installation cost.
- Please contact Plumber or Authorized Installer for the installation if needed.

- If Water leakage occurs due to improper installation, Please contact installer

Installing a SodaStream 60 L CO2 Carbonator

To use the Sparkling Water feature on your refrigerator, you need to install a Sodastream 60 L CO2 Carbonator. You can pick up the SodaStream 60 L CO2 Carbonator at retailer near you and your first Sodastream CO2 Carbonator is free.

Purchasing SodaStream 60 L CO2 Carbonators

- Purchase SodaStream 60 L Carbonators at the nearest Sodastream retailer or on line.
- USE ONLY SODASTREAM 60 L CARBONATORS. SAMSUNG and SODASTREAM are not legally responsible for any damage, including, but not limited to, property damage caused by gas leakage from the use of generic carbonators (or CO2 cylinders). The sparkling water system in your SAMSUNG refrigerator is designed to work ONLY WITH SODASTREAM 60 L CARBONATORS.
- We suggest buying extra Carbonators for later use. Store extra Carbonators in a cool, open space, well out of the reach of children. Do not store Carbonators in the refrigerator.

If sparkling water is produced when the internal refrigerator temperature or the temperature of the CO2 cylinder is high, you may hear a “horn sound”. When you turn on your refrigerator for the first time, you should not generate sparkling water production until after approximately 2 hours. When you purchase a new CO2 cylinder, be sure to store it in a cool dry place until you are ready to install it (23 ~ 68 °F (-5 ~ 20 °C)). If the cylinder is stored in higher temperatures, it may build up extra internal pressure, which could create a “horn sound” when sparkling water is produced.

Water Line Hookup

- Make sure that you have connected the refrigerator to a water line before installing the cylinder.

Installing a Carbonator into the Refrigerator

To install a new SodaStream 60 L Carbonator in the refrigerator, follow these steps:

1. Open the CO2 cylinder cover.
 - The sparkling water maker is turned off by default. Since the sparkling water maker is turned off, the “OFF” icon on the display is turned on.



2. Attach the SodaStream 60 L Carbonator to the Regulator, and then rotate it clockwise.

- You must use a Sodastream™ CO2 cylinder (60 L).
- Replacement SodaStream cylinders are available for easy exchange or refill at local Sodastream retailers.
- Wrap the used cylinder and return it to the person who delivers the new cylinder in USA and Canada. In Australia and New Zealand, please return empty CO2 Cylinder to the service or information counter at your local retailer for exchange/refill.

All costs associated to the refill or exchange of the CO2 Cylinder are that of the refrigerator owner.

Thread of CO2 cylinder is different according to country by country.



3. Push the SodaStream 60 L Carbonator into the Support.



4. Lock the SodaStream 60 L Carbonator into place by pressing the Lever.

- The inner pressure of the Carbonator may make it difficult to press the lever down. Hold the lever as shown in the illustration on the right, and then push down.

- If you don't lock the Carbonator into place, the refrigerator won't produce sparkling water.
- If the Carbonator is not tightly connected to the Regulator, it will leak CO2 gas, producing a hiss. If this occurs, repeat Steps 2, 3, and 4, making sure that the Carbonator is firmly attached and locked into place.



5. The sparkling water concentration is set to '2' by default.

Press the “Sparkling Water” button to set the concentration to a desired level and press and hold the Quick Sparkling button for 3 seconds to activate the Fill Up. If the Sparkling Water function is deactivated, press and hold the Sparkling Water or Quick Sparkling button for 3 seconds to reactivate it. Once the CO2 cylinder is reset, sparkling water is produced.

- To produce sparkling water, the sparkling water tank is filled with water and the CO2 gas is injected according to the configured concentration.
- To remove foreign substances that may exist in the sparkling water tank, discard the first 1.2 L of sparkling water.
- The sparkling water will not dispense while it is producing. When the numbers () next to the sparkling water icon stops blinking, Sparkling water can be dispensed.

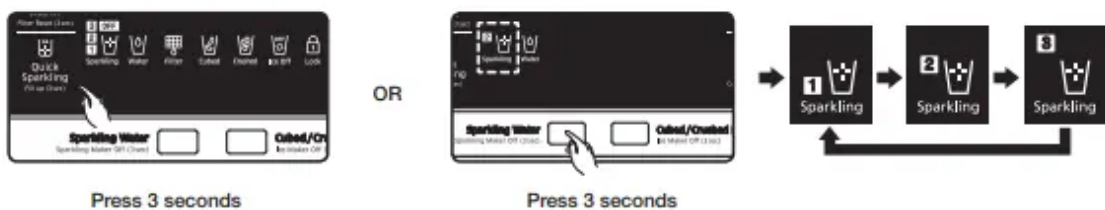

- To Uninstall the CO2 cylinder, follow the above step #1 ~ #4 in reverse order.

COMPLETING THE SET UP

Now that you have your new refrigerator installed in place, you are ready to set up and enjoy the features and functions of the appliance. By completing the following steps, your refrigerator should be fully operational.

1. Make sure your refrigerator is in an appropriate location with reasonable clearance between it and the wall. Refer to installation instructions in this

manual.

2. Once the refrigerator is plugged in, make sure the interior light comes on when you open the doors.

3. Set the Temperature control to the coldest temperature and wait for an hour. The freezer will get slightly chilled and the motor will run smoothly. Reset the refrigerator and freezer to the temperatures you want.

4. After you plug the refrigerator in, it will take a few hours to reach the appropriate temperature. You can store food and drinks in the refrigerator after the temperature is sufficiently cool.

- If condensation or water drops appear on both sides of the fridge door's central part, turn the Energy Saver mode off after removing the condensation. (See the explanation of the Energy Saver button in "Using the Control Panel".)

Operating your French Door Refrigerator

USING THE CONTROL PANEL

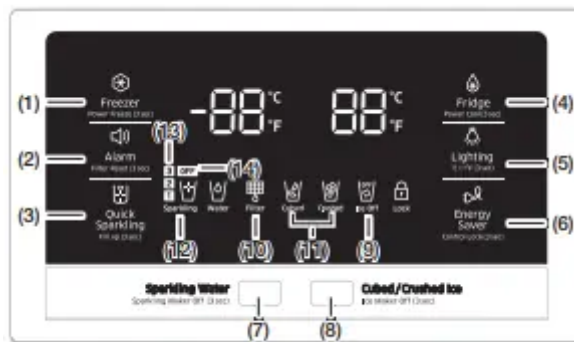

(1) Freezer / Power Freeze (3sec)

The Freezer button serves two purposes:

- To set the Freezer to your desired temperature.
- To turn the Power Freeze function on and off.

1. To set the Freezer temperature, touch the Freezer button. You can set the temperature between 5°F (-15 °C C) and -8 °F (-23 °C).

2. Power Freeze function

Touch and hold this button for 3 seconds to decrease the time needed to freeze products in the Freezer.

It can be helpful if you need to quickly freeze easily spoiled items or if the temperature in the freezer has warmed dramatically.

(For example, if the door was left open.)

When you use this function, the energy consumption of the refrigerator will increase.

Remember to turn it off when you don't need it and return the freezer to your original temperature setting.

If you need to freeze large amount of food stuff, activate Power Freeze function at least 20 hours before.

(2) Alarm / Filter Reset (3sec)

The Alarm button serves two purposes:

- To turn the door open alarm on and off
- To reset the water filter life indicator.

1. Door Alarm Function

If the door alarm is set to On, an alarm beeps if any refrigerator door is left open for more than three minutes.

The beeping stops when you close the door.

The door alarm function is pre-set to On in the factory.

You can turn it off by pressing and then releasing the Alarm button.

You can turn it back on in the same fashion. The icon lights up when the function is on.

When the Door Alarm function is on and the alarm sound is triggered, the Door Alarm Icon will blink while the alarm sounds.

2. Water Filter Life Indicator Function

After you replace the water filter, touch and hold this button for 3 seconds to reset the water filter life indicator.

When you reset the water filter life indicator, the Filter icon on the panel turns Off.

The Filter icon will turn red to let you know it is time to change the water filter after six months (about 300 gallons).

Some areas have large amounts of lime in their water, which causes the water filter to clog more quickly.

If this is the case in your area, you will have to change the filter more frequently than every six months.



(3) Quick Sparkling (Fill up (3 sec))

The Quick Sparkling button serves two purposes:

- To produce the sparkling water rapidly.
- To active the Fill up function.

1) Quick Sparkling Function

When press the Quick Sparkling button, the Icon will turn on and produce the sparking water rapidly. Press the Quick Sparkling button to instantly activate it if sparkling water is being produced. If not, this option will be applied next time you produce sparkling water. The concentration of carbonic in the sparking water will produce by 3 levels.

2) Fill Up Function

When replace the CO2 cylinder, press the 'Quick Sparkling/Fill up (3 sec)' button for 3 seconds to active the Fill up function. The water will fill in the sparkling water tank and CO2 gas will inject to water for make the sparkling water. The sparkling water which is made by this function can be produced differently depending on the amount and concentration of the remaining sparkling water in the tank. If the resultant sparkling level by Fill Up is not what you expected, select a desired sparkling level and empty the sparkling water tank so that the new setting is applied properly.

(4) Fridge / Power Cool (3sec)

The Fridge button serves two purposes:

- To set the Fridge to your desired temperature.
- To turn the Power Cool function on and off.

1. To set the Fridge temperature, press the Fridge button.

You can set the temperature between 44 °F (7 °C) and 34 °F (1 °C).

2. Power Cool function

Touch and hold this button for 3 seconds to decrease the time needed to cool products in the Refrigerator.

It can be helpful if you need to quickly cool easily spoiled items or if the temperature in the fridge has warmed dramatically. for example, if the door was left open)

(5) Lighting / °C ↔ °F (3sec)

The Lighting button serves two purposes:

- To turn the dispenser light on and off
- To switch the temperature units between °C and °F.

1. Light Function

Touching the Lighting button turns on the Dispenser LED lamp in continuous mode so that it stays on continuously.

The button also lights up.

If you want the Dispenser lamp to come on only when some one uses the dispenser, press the

Lighting button to turn the continuous mode off.

2. To switch the temperature units between °C and °F.

Touch and hold this button for 3 seconds to select the temperature display you want.

Each time you press and hold the button, the °C and °F temperature modes alternate and the °C or °F icon lights up, indicating your selection.

(6) Energy Saver (Control Lock (3 sec))

Energy Saver button serves two purposes:

- To turn the Energy Saver mode on and off
- To turn the Control Lock function on and off.

1) Energy Saver Function

When you turn Energy Saver on, the Energy Saver icon lights. Turn Energy Saver off and the icon goes off. The Energy Saver function's factory setting is "ON". If condensation or water drops appear on the doors, turn the Energy Saver mode off.

2) Control Lock Function

Touch and hold this button for 3 seconds to lock the display, the Flex Zone panel, and the dispenser buttons so the buttons can not be used. When Control Lock is on, the refrigerator does not dispense ice, water, or sparkling water, even if the Dispenser Lever is pressed. The Control Lock icon lights up to indicate you've activated the Child Lock function. Press 3 seconds to unlock.

(7) Sparkling Water (Sparkling Maker Off (3 sec))

The Sparkling button serves three purposes :

- To dispense sparkling (carbonated) water.
- To select the carbonation level of the sparkling water.
- To turn the Sparkling Water Production Function on and off.

1) To dispense sparkling (carbonated) water.

To dispense sparkling water, press the Sparkling Water button. When you press the Sparkling Water button while either Cubed Ice or Crushed Ice is selected, the Sparkling Icon will turn on. When there is no sparkling water left or the refrigerator is making sparkling water, the dispenser does not dispense sparkling water.

2) To select the carbonation level of the sparkling water.

When you press the Sparkling Water button while the Sparkling Water Icon is turned on, the Carbonation Level will change as follows; Medium (Level-2) → Strong (Level-3) → Weak (Level-1) → Medium (Level-2). The next time the refrigerator makes sparkling water, it applies the new Carbonation Level.

- If there is previously produced sparkling water inside the Sparkling Water tank, the refrigerator dispenses sparkling water with the previous carbonation level. (Changes in the carbonation level do not take effect until the next time the refrigerator makes sparkling water.)
- While the refrigerator is producing sparkling water, the Carbonation Level icons light up in rotation (Level-1 → Level-2 → Level-3 → Level-1, etc.). If you press the Sparkling Water button when the refrigerator is making sparkling water, the current carbonation level is displayed for several seconds, and then the Carbonation Level icon light rotation begins again. If you press the Sparkling Water button again while the current carbonation level is being displayed, the carbonation level changes. The change in the carbonation level will take effect the next time the refrigerator makes sparkling water.

3) Sparkling Water Production Function On / Off Each time you press this button for 3 seconds, you turn the Sparkling Water Production function on or off.

When you turn on the Sparkling Water Production function, the refrigerator begins to make sparkling (carbonated) water. (If you turn off the Sparkling Water Production function a few seconds after turning it on, sparkling water production will terminate. If more than a few seconds pass, the refrigerator will start producing sparkling water. While the refrigerator is producing sparkling water, it won't dispense sparkling water.) When you turn off the Sparkling Water Production function, the "OFF" Icon on the Display Panel turns on. When you turn on the Sparkling Water Production function, the "OFF" Icon on the Display Panel turns off. When the Sparkling Water Production function is off, the refrigerator does not make sparkling water.

If you turn off the function when the refrigerator is in the middle of making sparkling water, it halts the function after finishing the current operation. Your refrigerator was manufactured with the Sparkling Water Production function set to "OFF".

When you are connecting the water lines, or mounting or replacing the CO2 Cylinder, turn off the Sparkling Water Production function before you begin. Turn on the function only after you have completed the work. To produce sparkling water, you must install a CO2 Cylinder.

For instructions, see Installing and Using CO2 Cylinders.

(8) Cubed / Crushed Ice (Ice Maker Off (3 sec))

The Cubed/Crushed Ice button serves two purposes:

- To select the type of ice you want dispensed.
- To turn the Ice maker on and off.

1) Cubed / Crushed Function

To Select the type of ice. Press the Cubed/Crushed Ice button to select the type of ice you want dispensed. Each time you press the button, the cubed and crushed ice modes alternate and the Cubed or Crushed ice icon lights up, indicating your selection.

2) Ice Maker Off function

If you don't want to make more ice, Touch and hold this button for 3 seconds.



(9) Ice Off

If you don't want to make more ice, Touch and hold Ice Maker Off button for 3 seconds. The icon will light up and the Ice-Maker stops making ice.

We recommend you stop ice making if the following occur:

- There is enough ice in the ice bucket.
- You want to save water and energy.
- Water is not being supplied to the refrigerator.

If the ice maker function is ON, and the water line is not connected, there will be a water valve noise from the back of the unit. If this occurs, press the Ice Maker Off button for more than 3 seconds until the Ice Off Indicator () illuminates.

To save electricity, the Panel Display turns off automatically under the following conditions:

When no button has been pressed, when no doors are open, or when no Dispenser Lever has been pushed.

However, the icon indicating your cubed or crushed ice selection, will stay on.

When you press a button, open a door, or push a Dispenser Lever, the Panel Display will turn on again.

Except for the Energy Saver, Water, and Cubed/Crushed Ice buttons, all function buttons will become operational after you remove your finger from the button you are currently pressing.

(10) Filter

Water filter usage

This icon lights up when you need to change the filter, usually after the refrigerator has dispensed about 300 gallons of water (after about 6 months). After you install the new water filter, reset the filter indicator by touching and holding the Hold 3sec for Filter Reset button for seconds.

The icon will blink red for several seconds when you open or close the door.

- If water is not dispensing or dispensing slowly, you need to replace the water filter because the water filter is clogged.
- Some areas have large amounts of lime in their water, which causes the water filter to clog more quickly.

(11) Ice Type

Press the Cubed/Crushed Ice button to select the type of ice you want dispensed. Each time you press the button, the cubed and crushed ice modes alternate and the Cubed or Crushed ice icon lights up, indicating your selection



(12) Sparkling Icon

When you press the Sparkling Water button (Button 7), the Sparkling Water Icon goes on.

3

2

1

(13) Sparkling Water Production Level Icons

The Sparkling Water Production Level icons display the currently set Carbonation Level. When you press the Sparkling Water button while the

Sparkling Water Icon is turned on, the Carbonation Level will change as follows; Medium (Level-2) → Strong (Level-3) → Weak (Level-1) → Medium (Level-2).

- If there is previously produced sparkling water inside the Sparkling Water tank, the refrigerator dispenses sparkling water with the previous Carbonation Level. (Changes in the Carbonation Level do not take effect until the next time the refrigerator makes sparkling water.)
- While the refrigerator is producing sparkling water, the Carbonation Level icons light up in rotation (Level-1 → Level-2 → Level-3 → Level-1, etc.). If you press the Sparkling Water button when the refrigerator is making sparkling water, the current carbonation level is displayed for several seconds, and then the Carbonation Level icon light rotation begins again. If you press the Sparkling Water button again while the current carbonation level is being displayed, the carbonation level changes. The change in the carbonation level will take effect the next time the refrigerator makes sparkling water.
- If you change the carbonation level when the refrigerator is making sparkling water, the refrigerator produces sparkling water at the previous carbonation level.

OFF (14) Sparkling Icon

Each time you press Sparkling Water button (button 7) for 3 seconds, you turn the Sparkling Water Production function on or off. When you turn off the Sparkling Water Production function the Sparkling Water Off Icon on the Display Panel turns on. When you turn on the Sparkling Water Production function, the Off Icon on the Display Panel turns off.

If a water leak is detected in the Sparkling Water Production Module, the Off Icon blinks, the refrigerator stops dispensing and producing sparkling water, and the Sparkling Water Production function automatically switches to OFF. In addition, the Sparkling Water Production function will not turn on, even if you press the Quick Sparkling button or Sparkling Water button for 3 seconds.

CHANGING THE WATER FILTER

WARNING: To reduce risk of water damage to your property **DO NOT** use generic brands of water filters in your SAMSUNG Refrigerator.

USE ONLY SAMSUNG BRAND WATER FILTERS. SAMSUNG will not be legally responsible for any damage, including, but not limited to property damage caused by water leakage from the use of a generic water filter. SAMSUNG Refrigerators are designed to work **ONLY WITH SAMSUNG Water Filter.**

The Filter light turns red to let you know when it is time to change your water filter cartridge.

To give you time to get a new filter, the red light comes on just before the capacity of the current filter runs out.

Changing the filter on time provides you with the freshest, cleanest water from your refrigerator.

To Change the Water Filter

1. Shut off the water supply. Then, turn the water filter (1) about 1/4 turn, counter-clockwise.
2. Pull the water filter (1) from the case filter (2).
 - To change the water filter more easily, shut off the water supply valve.
 - Sometimes, it is hard to disassemble the water filter because impurities in the water cause it to stick. If you are having difficulties, grip the water filter firmly and pull it hard.
 - When you pull the water filter, a little water can leak from the opening. This is normal. To minimize the water leaks, keep the filter cartridge horizontal when you pull it.
 - To prevent overflow, empty the water filter tray (3) and dry around the filter case (2).
3. Insert the new filter into the filter case (4).
4. Push the filter, and then turn it clockwise until it locks.
 - If you have trouble inserting the water filter because of high water pressure, shut off the water supply valve.
 - The locked symbol should be lined up with the indicator line.
5. Touch the “Alarm/Filter Reset (3 sec)” button ((Filter Reset)) for about 3 seconds to reset the water filter. The color of the indicator () changes from red to off.
6. If you turned off the water supply, turn it back on.

Removing any residual matter inside the water supply line after installing the water filter.

1. Turn ON the main water supply if you turned it off when you installed the water filter.
2. Run of water through the dispenser until the water runs clear (approx. 6 to 7 minutes). This will clean the water supply system and remove air from the lines.
3. Additional flushing may be required in some households.
4. Open the Refrigerator door and make sure there are no water leaks coming from the water filter.

Reverse Osmosis Water Supply

IMPORTANT :

The pressure of the water supply coming out of a reverse osmosis system going to the water inlet valve of the refrigerator needs to be between 35 and 120 psi (241 and 827 kPa). If a reverse osmosis water filtration system is connected to your cold water supply, the water pressure to the reverse osmosis system needs to be a minimum of 40 to 60 psi (276 to 414 kPa.) If the water pressure to the reverse osmosis system is less than 40 to 60 psi (276 to 414 kPa):

- Check if the sediment filter in the reverse osmosis system is blocked.
Replace the filter if necessary.
- Allow the storage tank on the reverse osmosis system to refill after heavy usage.
- If your refrigerator has a water filter, it may further reduce the water pressure when used in conjunction with a reverse osmosis system.
Remove the water filter.

If you have questions about your water pressure, call a licensed, qualified plumber.

CONTROLLING THE TEMPERATURE

Basic temperature of Freezer and fridge compartments

The basic temperature and recommended temperatures of the Freezer and Refrigerator Compartments are 0 °F and 37 °F(or -18 °C and 3 °C) respectively. If the temperature of the Freezer and Refrigerator Compartments are too high or low, adjust the temperature manually.

Controlling the Freezer temperature

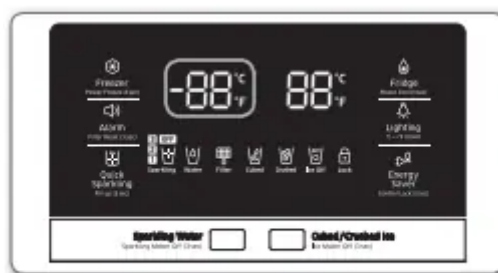

Recommend Temp (Freezer) : -19 °C

The Freezer temperature can be set between 5 °F(or between -23 °C and -15 °C) to suit your particular needs. Press the Freezer button repeatedly until the desired temperature is shown in the temperature display.

The temperature display will change by 1 °F (or 1 °C) with each press. See below.

Centigrade : -19 °C → -20 °C → -21 °C → -22 °C → -23 °C → -15 °C → -16 °C → -17 °C → -18 °C → -19 °C.

Keep in mind that foods like some ice cream may melt at -15.5 °C.

The temperature display will move sequentially from -23 °C and -15 °C.

Controlling the fridge temperature



Recommend Temp (Fridge) : 3 °C

The fridge temperature can be set between 34 °F and 44 °F (or between 1 °C and 7 °C) to suit your particular needs. Press the Fridge button repeatedly until the desired temperature is shown in the temperature display.

The temperature will change by 1 °F (or 1 °C) with each press. See below.

Centigrade : 3 °C → 2 °C → 1 °C → 7 °C → 6 °C → 5 °C → 4 °C → 3 °C

The temperature control process for the Fridge works just like the Freezer process. Press the Fridge button to set your desired temperature. After a few seconds, the Fridge will begin adjusting towards the newly set temperature. This will be reflected in the digital display.

- The temperature of the Freezer or Fridge may rise when you open the doors too frequently, or if a large amount of warm or hot food is placed inside.
- A rise in temperature may cause the digital display to blink. Once the Freezer and Fridge temperature return to their normal set temperatures, the blinking will stop.
- If the blinking continues, you may need to “reset” the Refrigerator. Try unplugging the appliance, waiting for around 10 minutes and then plugging the power cord back in.
- If there is a communication error between the Display and Main Controller, the Convertible Display light may blink. If the blinking continues for a long period of time, please contact a Samsung Electronics Service Center

USING THE COLD WATER DISPENSER

Push the appropriate ice/ sparkling button to select what you want dispensed.

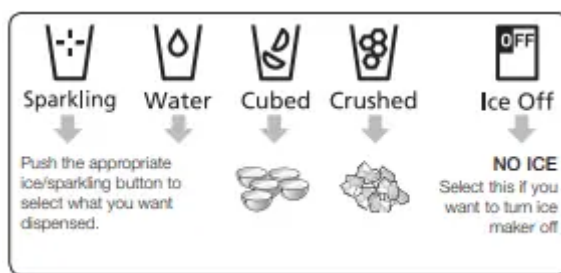

Using the ice lever (1)

Push the Ice/Sparkling lever dispenser (1) gently with your glass. Ice or Sparkling will be released from the dispenser. You can choose the type of ice or sparkling water by pushing the ice/sparkling button first.

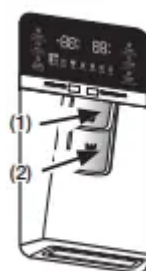

Using the Water lever (2)

Push the Water lever dispenser (2) gently with your glass. Water will be released from the dispenser.

If you push the water and Ice lever at about the same time, the dispenser operates only the option you actually selected or pushed first.

Please wait 1 second before removing the glass after dispensing water to prevent spills. Do not pull out the dispenser lever after dispensing ice or water. It comes back automatically

Using the Ice & Water Dispenser together

To get Ice and water, select the type of ice, then push the Ice/Sparkling lever (1) first for ice, and then move your glass down and press the water dispenser lever (2) for water.

Maintaining the Ice Bucket

- To clean the ice bin/bucket, wash with a mild detergent, rinse well, and dry thoroughly it. Do not use harsh or abrasive cleaners or solvents.
- Ice is made in cubes. When you select “Crushed”, the ice maker grinds the ice cubes into crushed ice.

- When you select Cubed Ice after using the Crushed Ice mode, a small amount of residual crushed ice might be produced.
- The ice cubes generated by the rapid ice making process will look white, which indicates they were generated normally.
- As the ice maker in the refrigerator room makes ice cubes even faster, move the ice cubes from the refrigerator ice bin to the freezer ice bin if you need more ice cubes. • If ice doesn't come out, pull out the ice bucket and press the test button located on the right side of ice maker. See the illustration below.
- Do not press the test button continuously when the tray is filled with ice or water. Water may overflow or ice may jam the bucket.

Making Ice

- To fill the ice bucket to maximum capacity after installation, follow these steps:
 1. Allow your refrigerator to operate and cool down for 24 hours (or 1 full day).

Waiting 24 hours will allow your ice maker to cool properly.
 2. Dispense 4 to 6 ice cubes into the glass.
 3. After 8, and then 16 hours, dispense a full glass of ice.
- To test the ice maker, press the Test button on the ice maker. You will hear the refrigerator chime (ding-dong). When the chime sounds, release the Test button.
- The chime sounds automatically again to let you know the ice maker is working well.

If you want to remove the ice cubes without using the ice bucket, please turn the ice maker off and remove the ice maker's front cover from the ice maker. Note that the ice cubes in the ice maker can spill out over the drawer.

Do not put food in the ice bucket. If you store food in the ice bucket, the food can strike the ice maker when you open or close the door, causing damage to the ice maker.

To prevent this problem, after a power failure, pull out the ice bucket and discard the residual ice or water.

If you use all the ice at once, you must repeat ice making Steps 2 and 3, left. However, only wait 8 hours before dispensing the first 4 to 6 ice cubes. This will replenish the ice cubes and ensure maximum ice production

Using the ice off Function

When you select the Ice Off mode, remove all ice cubes from the bucket.

If you leave the ice cubes in the bucket, the ice cubes may clump together, making it difficult to remove them.

To remove the ice bucket safely and avoid injury, hold the bottom of the bucket with one hand and the side of the bucket with the other.

Then, lift up on the ice bucket, and pull it straight out.

To put the ice bucket back in, push it firmly straight back.

- If the ice bucket is not pushed firmly into place, ice in the bucket can melt.

If the bucket does not fit, turn the helix 90 degree (see the last illustration on the right, below) and try again.

Going on vacation...

If you are going on a long vacation or business trip and won't use the water or ice dispensers for a long time:

- Close the water valve. Otherwise, water leakage may occur.
- Remove all food and ice in the ice bucket.
- Unplug the refrigerator.
- Wipe excess moisture from inside and leave the doors open. Otherwise, odor and mold may develop.

Ice Maker Do's and Don'ts

- Do not put your fingers, hands or any other unsuitable objects in the chute or ice-maker bucket.
 - It may result in personal injury or material damage.
- Never put your finger or any other objects in the dispenser opening.
 - It may cause injury.
- Do not try to disassemble the ice maker.
- Do not wash or spray the ice bucket with water while it is in the refrigerator. Remove it to clean it.

Water clouding phenomenon

- All water provided to refrigerators flows through the core filter which is an alkaline water filter. In this process, the pressure in the water that has flowed out of the filter gets increased, and oxygen and nitrogen become saturated. When this water flows out in the air, the pressure plummets and the oxygen and nitrogen get supersaturated so that they turn into gas bubbles. The water could look misty due to these oxygen bubbles. The water may look temporarily cloudy due to these oxygen bubbles. After a few seconds, the water will look clear.

Parts And Features

Review the illustration below to become more familiar with the parts and features of your refrigerator.

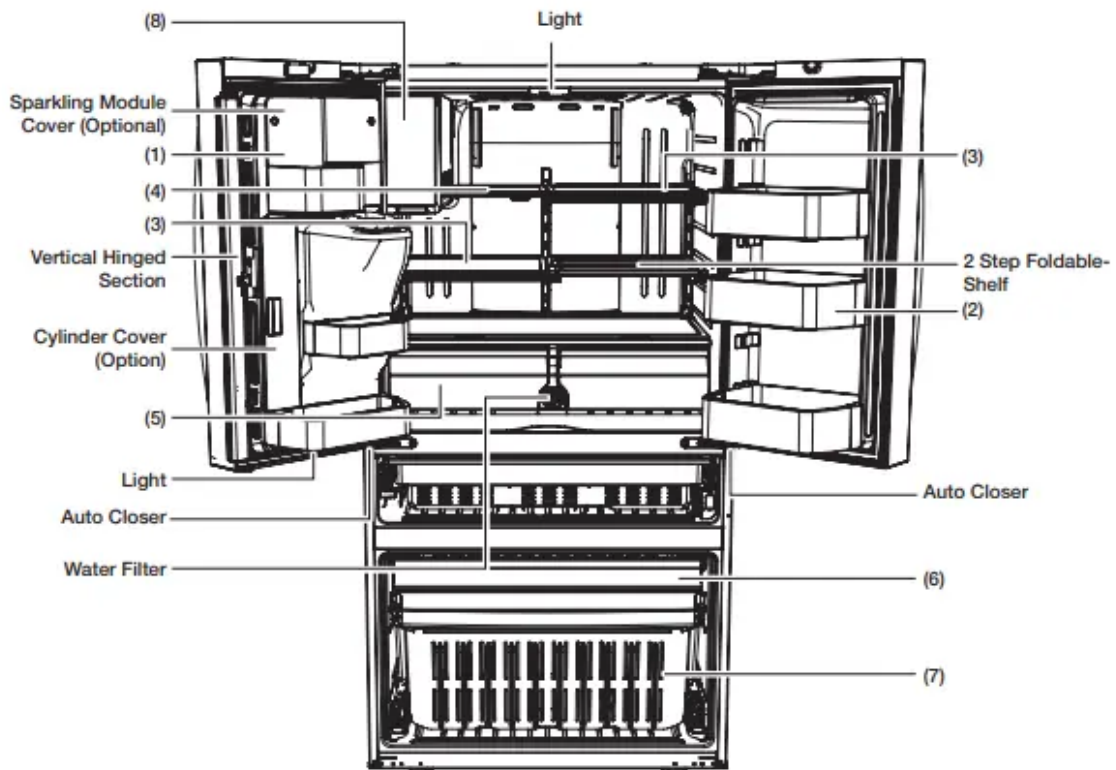

- When closing the door, make sure the Vertical Hinged Section is in the correct position to avoid scratching the other door. If the Vertical Hinged Section is reversed, put it back to the right position and close the door. Moisture may appear at times on the Vertical Hinged Section. The door handle may become loose over time. If this happens, tighten the bolts found on the inside of the door. If you close one door with a lot of force, the other door may open.
- When the door opens, the interlock switch automatically turns off the auger motor in the ice maker for safety reasons.

CAUTION When you open the door, you might hear the sound of sloshing water because the Sparkling Water Tank is inside the door.

(1) Sparkling Water Tank (Optional)

Use the Sparkling Water Tank function, and enjoy the sparkling water directly from the tank any time you want.

(2) Door Bins

Designed to handle large, bulky items such as gallons of milk or other large bottles and containers.

(3) Slide-Shelf

It is easier to take out the food.

(4) Foldable-Shelf

The shelf functions both a full depth shelf or can be tucked in to accommodate taller containers.

(5) Vegetable & Fruit Drawers

Used to preserve the freshness of your stored vegetables and fruits.

(6) Auto Pull Out Drawer

Best used to store meats or dry foods. Stored food should be placed in a container or wrapped securely using foil or other suitable wrapping materials.

(7) Freezer Drawer Bin

Best used to store meats or dry foods. Stored food should be wrapped securely using foil or other suitable wrapping materials or containers.

(8) FF Ice Maker

The direct cooling system enables you to make sparkling water in a quick, convenient way.

Door bins

Your refrigerator ships with door bins of different types and sizes. If the door bins for your refrigerator were packaged separately, use the figure below to help you position the bins properly. The number of door bins provided may differ with the model.

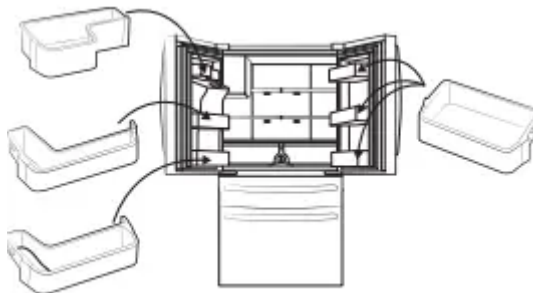

USING FLEX ZONE

The Flex Zone is a full-width drawer with an adjustable temperature control.

You can use the Flex Zone for large party trays, deli items, wines, pizzas, beverages, or miscellaneous items.

There is a temperature sensor which lets you adjust the amount of cold air allowed into the Zone.



The control buttons are located on the cap door center.

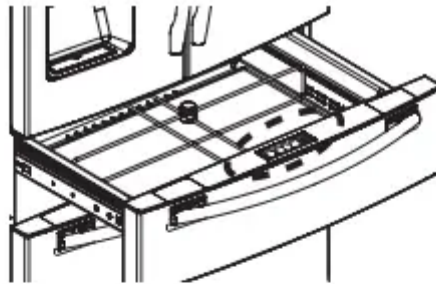

Temperature Selection Button

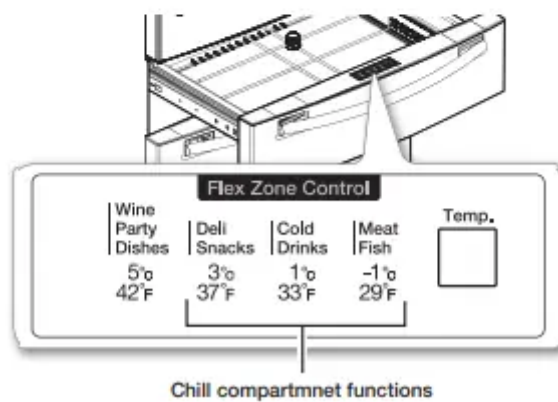

- Press the Temp. button repeatedly until your desired mode is lit.
- Each time you press the Temp. button, you change the mode in this order : Meat/Fish mode (-1 °C), Cold Drinks mode (1 °C), Deli/Snack mode (3 °C), Wine/Party Dishes mode (5 °C). Initially, the Cold Drinks mode is selected. The refrigerator will adjust the temperature in the Flex Zone automatically to the temperature you selected.
- The Flex Zone Temp. Display may change depending on the number of items inside, where they are located, the ambient temperature, and how often the door is opened.

1. When “Wine/Party Dishes” is selected, the temperature of the Flex Zone will be kept around 5 °C. This feature helps keep food fresh for a long time.

2. When “Deli/Snack” is selected, the temperature of the Flex Zone will be kept around 3 °C. This feature helps keep food fresh for a longer time.

3. When “Cold Drink” is selected, the temperature of the Flex Zone will be kept around 1 °C. This feature helps keep drinks cold and refreshing.

4. When “Meat/Fish” is selected, the temperature of the Flex Zone will be kept around -1 °C. This feature helps keep meat or fish fresh for a longer time

Examples of food items you can store in the Flex Zone by temperature setting.

Wine Party Dishes	Deli Snacks	Cold Drinks	Meat Fish
• wine	• pineapples	• bottled water	• steaks
• cocktails	• lemons	• juice	• cold cuts
• cakes	• biscuits	• soft drinks	• bacon
• cheeses	• potatoes	• beer	• chili dogs

RECOMMENDED LOCATION FOR THE FOLDABLE SHELF

The Foldable Shelf folds up from the center, giving you more storage area for tall items without your having to re-arrange the shelves.

- Install the Foldable Shelf on the right side of the refrigerator.
- If you install the Foldable Shelf on the left side, the ice maker will prevent the shelf from folding completely.
- To use, push the front portion of the shelf back gently so that the shelf folds up from the middle

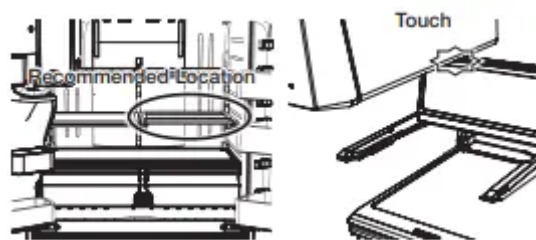

REMOVING THE REFRIGERATOR ACCESSORIES

1. Door Bins

• Door Bins (1)

- To remove - Simply lift the bin up and pull straight out.
- To relocate - Slide it in above the desired location and push down until it stops.

• Door Bins (2)

- To remove : Take the right side of the bin out by lifting it at an angle along the guide, and then take the left side out by pulling it from the door.
- To relocate : Slide it into the original location and push down until it sticks.

- Sparkling Water model door bins (2)

- To remove : Take the right side of the bin out by lifting it at an angle along the guide, and then take the left side out by pulling it from the door.
- To relocate : Align the positions of the Door Bin's holes carefully, and then slide the bin in above the desired location and push down until it stops.
- When removing and re-assembling the Bottom Door Bin of the Sparkling Water model, open the Cylinder Cover and tilt the Cylinder towards the front first.

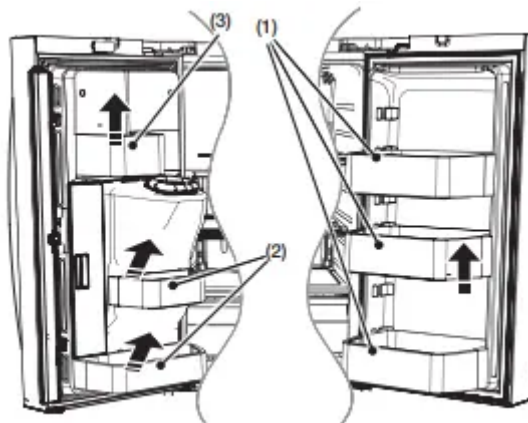

- Sparkling Water model door bins (3).

CAUTION: Do not remove Sparkling Water model door bin (3). To clean, wipe it completely with a clean cloth without removing it. Do not remove door bins (3). Do not adjust a bin full of food. Remove the food first.

To remove dust from the bins, remove the guard and wash in water.

CAUTION :Injuries can occur if large bottles in the bottom door bins fall over when you open the doors. Open the doors carefully.

Injuries can occur if the door bins are not firmly connected to the doors. Do not allow children to play with the bins. Sharp corners of the bins may cause injury

2. Tempered Glass shelves

- To remove - Tilt up the front of the shelf in the direction shown (1) and lift it up vertically (2). Pull the shelf out.
- To relocate - Tilt the front of the shelf up and guide the shelf hooks into the slots at a desired height.

3. Foldable Shelf

- To remove : After removing the Shelf Front, lift up the Shelf and remove it.

- To re-install : Hook the Shelf on the Angle Frame and re-attach the Shelf Front to the Foldable Shelf

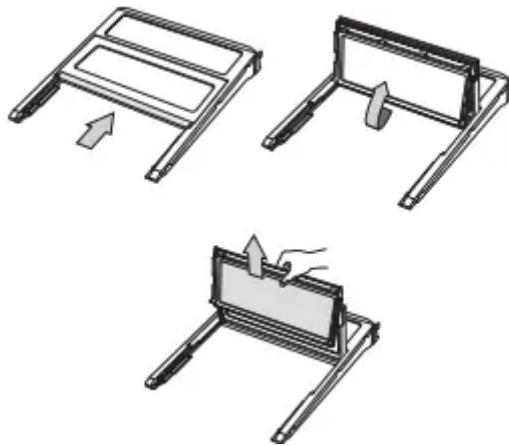

4. Vegetable & Fruit Drawers

- **Door Bins**

- Before removing the Vegetable and Fruit drawers, remove the bottom door bins on the left and right doors as shown in the next column.
- To remove: Simply lift the bin up and pull straight out.

- **Sparkling Water Model Door Bins**

- To remove : Take the right side of the bin out by lifting it at an angle along the guide, and then take the left side out by pulling it from the door.
- When removing and re-assembling the Bottom Door Bin of the Sparkling Water model, open the Cylinder Cover and tilt the Cylinder towards the front first.



- **Tilt up the front of the drawer and pull straight out, and pull out the drawer after moving slightly in the direction of the arrow.**

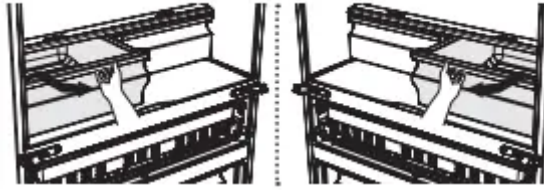

- **To re-install**

- Insert the drawer into the frame rails, and then push back into place.
- Slide each bin in above the desired location, and then push down until it stops.

5. Flex Zone

- To remove the Flex Zone : Pull the Flex door out to full extension. Lift the Flex Zone up, pulling it to your body with both hands
- To re-install the Flex Zone : Open the Flex door to full extension. Tilt the front of the Flex Zone up, place the back of the Flex Zone onto the rails, and then lower the front until the whole Zone rests on the rails.

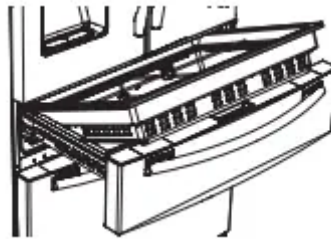

When the Flex Zone or LED lighting is not working, check the connectors [(1), (2) shown below] for cracks or leaks.

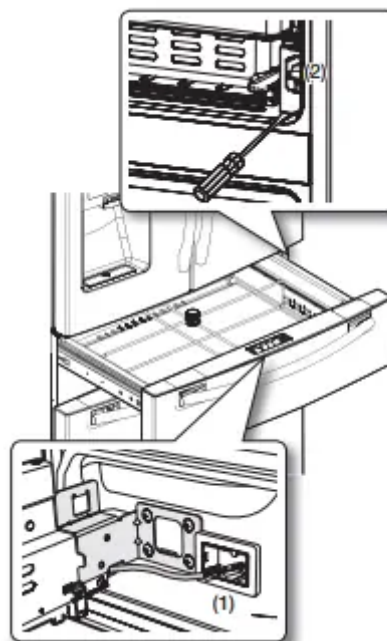

1. Refer to page 20 for disassembly instructions.
2. Open the cap cover rail with a flat-blade screw driver.

Using the doors

Ensure that the doors close all the way and are securely sealed.

When the refrigerator door is only partially open, it will automatically close. If the door is opened more than its auto close range, it will remain open. You must close it manually

REMOVING THE FREEZER ACCESSORIES

1. Freezer Room Guard

- **To remove** : Remove the freezer room guard (1) by lifting the guard up.
- **To relocate** : Push down until the guard (1) locks into place.

2. Super Extended Drawer

To remove - Pull the drawer out to full extension. Tilt up the rear of the drawer and lift straight out.

To re-install - Place the drawer onto the rails (4) by tilting it up. Lower the drawer into place until it is horizontal and slide the Drawer (3) in.

3. Freezer Drawer

- **To remove the freezer drawer** - Pull the freezer drawer out fully. Tilt up the rear of the bin and lift it out to remove.
- **To re-install the freezer drawer** : Place the bin into the rail assembly

CLEANING THE REFRIGERATOR

Caring for your Samsung French Door Refrigerator prolongs the life of your appliance and helps keep the refrigerator free of odor and germs.

To clean the refrigerator, follow these steps:

1. Unplug the power cord of the refrigerator.
2. Slightly dampen a soft lint-free cloth or paper towel with water.
 - Do not use any kind of detergent to clean the refrigerator because that can discolor or damage the refrigerator.
3. Wipe the inside and outside of refrigerator until it is clean and dry.
4. Plug the power cord of the refrigerator back in.

Cleaning the Interior

Clean the inside walls and accessories with a mild detergent and then wipe dry with a soft cloth. You can remove the drawers and shelves for a more thorough cleaning. Just make sure to dry drawers and shelves before putting them back into place.

Cleaning the Exterior

Wipe the control panel and digital display with a damp, clean, soft cloth. Do not spray water directly on the surface of the refrigerator. The doors, handles, and cabinet surfaces should be cleaned with a mild detergent and then wiped dry with a soft cloth. To keep your appliance looking its best, polish the exterior once or twice a year.

CAUTION:

- Do not spray water directly on the refrigerator. Use a clean, damp cloth to clean.
- Do not use benzene, thinner, or Clorox for cleaning. They may damage the surface of the appliance and may cause a fire.
- You can erase the printed letters on the display if you apply stainless cleaner directly to the area where the letters are printed.

Cleaning the Ice / Water Dispenser

Push down one end of the tray dispenser and remove it. Wipe the Ice / Water Dispenser with a clean and soft cloth.

CAUTION When using the crushed ice selection from the dispenser some residual ice chips may start to collect in the ice chute. To prevent that residual ice from melting and running out of the chute, you should clean out the residual ice when you see it start to collect in the ice chute.



Cleaning the Rubber door seals

If the rubber door seals are dirty, the doors may not close properly, and the refrigerator will not operate efficiently. Keep the door seals free of dust or stains by cleaning the doors with a mild detergent and damp cloth. Wipe dry with a clean, soft cloth.

CAUTION: Do not clean the refrigerator with benzene, thinner, or car detergent. These substance could cause a fire.

Cleaning the rear side of the refrigerator

To keep cords and exposed parts free of dust and dirt accumulation. Vacuum the rear side of the appliance once or twice a year.

CAUTION: Do not remove the back cover (1). You could suffer an electric shock

FOOD STORAGE TIPS

Troubleshooting

The refrigerator does not work at all or it does not chill sufficiently.

- Check if the power plug is properly connected.
- Check if the set temperature on the digital display is warmer than the freezer or fridge inner temperature. If it is, set the refrigerator colder.
- Is the refrigerator in direct sunlight or located near a heat source?
- Is the back of the refrigerator too close to the wall, preventing proper ventilation? If so, it may not be able to cool sufficiently. Keep it an appropriate distance from the wall.

The food in the fridge is frozen.

- Check if the set temperature on the digital display is too low. If so, raise the set temperature inside the refrigerator.
- Is the temperature in the room too low? Set the refrigerator warmer.
- Did you store the food which is juicy in the coldest part of the refrigerator? Try moving those items to the other shelves in the fridge instead of keeping them in the colder areas or bins.

You hear unusual noise or sounds.

- Check if the refrigerator is level and stable.
- Is the back of the refrigerator too close to the wall, preventing proper ventilation? Try moving the back of the refrigerator at least 2 inches from the wall.
- Was anything dropped behind or under the refrigerator?
- If you hear a “ticking” sound from inside the refrigerator, this is normal. It occurs because various parts contract or expand in response to temperature changes in the refrigerator interior.

- If it sounds as if something is hitting something else inside the refrigerator, this is normal. The sound is caused by the compressor operating at high capacity.

The cabinet-door sealing area of the appliance is hot and condensation is occurring.

- Some heat is normal as anti-condensators are installed in the vertical hinged section of the refrigerator to prevent condensation.
- Is the refrigerator door ajar? Condensation can occur when you leave the door open for a long time.

Ice Maker is not producing ice.

- Did you wait for 12 hours after installation of the water supply line before making ice?
- Is the water line connected and the shut-off valve opened?
- Did you manually stop the ice making function?
- Is the freezer temperature too warm? Try setting the freezer temperature lower.

You can hear water bubbling in the refrigerator.

- This is normal. The bubbling comes from refrigerant circulating through the refrigerator.

There is a bad smell in the refrigerator.

- Check for spoiled food.
- Foods with strong odors (for example, fish) should be tightly covered.
- Clean out your freezer periodically and throw away any spoiled or suspicious food. When cleaning the inside of the fridge, store food elsewhere and unplug the appliance. Wipe with a dry dishcloth after 2-3 hours and then circulate air inside the refrigerator.

Frost forms on the walls of the freezer.

- Is the air vent blocked? Remove any obstructions so air can circulate freely.
- Allow sufficient space between the stored foods for efficient air circulation.
- Is the freezer drawer closed properly? If the freezer drawer is not completely closed or is blocked, humidity from outside may enter and cause severe frost to form.

Water dispenser is not functioning.

- Is the water line connected and the shut-off valve opened?
- Has the water supply line tubing been crushed or kinked?
- Make sure the tubing is free and clear of any obstruction.
- Is the water tank frozen because the fridge temperature is too low? Try selecting a warmer setting on the Digital display.
- Is the Child Lock on?

Auto close system does not work with the freezer door.

- Is there an imbalance between the right and left parts of the door?
- Open and close the door smoothly 1~2 times. After you do this, the auto close system usually works properly again
- Try opening the door smoothly to avoid unbalancing the right and the left part of the door.

Sparkling water is not dispensed.

- Is the water line connected and the shut-off valve opened?
- Is the Sparkling water icon selected?
- Is the Sparkling Water Production Function Off icon on? Press the Sparkling Water button for 3 seconds to turn on sparkling water production. The Sparkling Water Production function is set to OFF at the factory. Set it ON to get sparkling water.
- Is the sparkling water icon blinking? If the sparkling water icon is blinking, the refrigerator is in the middle of producing sparkling water. Please wait until the icon stops blinking.
- Is the Sparkling Water Cylinder empty? If the SodaStream Carbonator runs out of CO₂, water might not be dispensed or the dispensed water might be weak. Please change the cylinder.
- Is the refrigerator door open? If the door is open, Sparkling water/Water/Ice are not dispensed.
- Is the cylinder lever unlocked? Please open the cylinder cover and lock the cylinder lever.
- Is the Control Lock on?

The Quick Making option makes a whirling noise while in process.

- While the Quick Making option is active, the cylinder cycles through injecting and discharging the CO₂ gas, which can make such a noise.

The taste of the sparkling water is weak.

- Increase the Sparkling Level of the sparkling water.
- When the taste of the sparkling water is too weak or there is no other taste than water, replace the SodaStream Carbonator with a new one.
- If you use the Fill Up (3 sec) option after replacing the cylinder, the sparkling water tastes stronger or weaker than normal, depending on the amount and concentration of the remaining gas in the water tank.

Condensation or water drops forms on both sides of fridge door's central part.

- Condensation or water drops may form if the humidity is too high while the refrigerator is operating.
- If condensation or water drops appears on both sides of fridge door's central part, turn the Energy Saver mode off after removing the condensation. (See the explanation of the Energy Saver button in "Using the Control Panel")

Warning

This content is compiled from multiple sources and is provided for reference purposes only. It may not be complete or fully applicable to all situations. If you are unable to resolve your issue, please contact the product manufacturer or an authorized service provider for official support.