

## Introducing your new range

### Overview

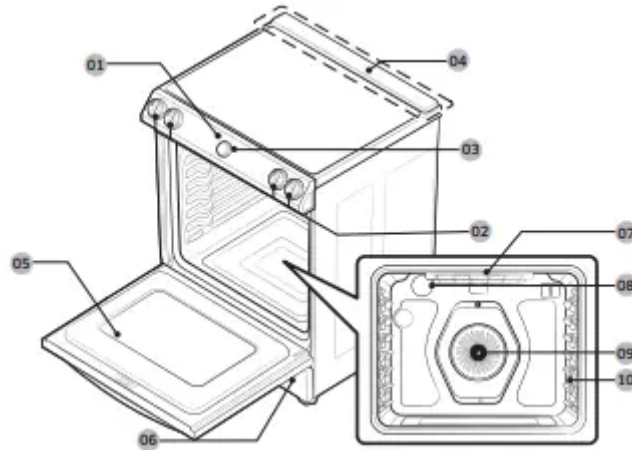

- 01 Control panel
- 02 Surface control knobs (See page for more information.)
- 03 Dial knob (See page 23 for more information.)
- 04 Vent
- 05 Dual door
- 06 Storage drawer
- 07 Broil oven heater
- 08 Oven light
- 09 Convection system
- 10 Shelf position

### What's included



Wire racks (2) \*

Air fry tray (1) \*

Temperature probe (1) \*

**NOTE:** If you need an accessory marked with a \*, you can buy it from the Samsung Contact Center

## Before you begin

Clean the oven thoroughly before using it for the first time. Then, remove the accessories, set the oven to bake, and then run the oven at 400 °F for 1 hour. There will be a distinctive odor. This is normal.

Ensure your kitchen is well ventilated during this conditioning period.

### Energy saving tips

- During cooking, the oven door should remain closed except when you turn food over. Do not open the door frequently during cooking to maintain the oven temperature and to save energy.
- If cooking time is more than 30 minutes, you can switch the oven off 5-10 minutes before the end of the cooking time to save energy. The residual heat will complete the cooking process.
- To save energy and reduce the time needed for reheating the oven, plan oven use to avoid turning the oven off between cooking one item and the next.
- Whenever possible, cook more than one item at a time.

## Surface cooking

### About surface cooking

#### BEFORE COOKING

- Do not use the glass cooktop surface as a cutting board.
- Do not place or store items that can melt or catch fire on the glass cooktop, even when it is not being used.
- Turn the surface units on only after placing cookware on them.
- Do not store heavy items above the cooktop surface. They could fall and damage it.

#### DURING COOKING

- Do not place aluminum foil or plastic items, such as salt and pepper shakers, spoon holders, or plastic wrappings on the range when it is in use. The hot air from the vent could melt plastics or ignite flammable items.
- Make sure the correct surface unit is turned on.
- Never cook directly on the glass. Always use cookware.
- Always place the pan in the center of the surface unit you are cooking on.
- Never leave surface units unattended while using a high heat setting. Boilovers cause smoking and greasy spillovers that may catch on fire.

- Turn the surface units off before removing cookware.
- Do not use plastic wrap to cover food. Plastic may melt onto the surface and be very difficult to remove.
- The cooling fan can be operated during cooktop cooking.

#### **AFTER COOKING**

- Do not touch the surface units until they have cooled down.
- The surface may still be hot and burns may occur if you touch the glass surface before it has cooled down sufficiently.
- Immediately clean spills on the cooking area to prevent a tough cleaning chore later.
- If cabinet storage is provided directly above the cooking surface, make sure that the items are infrequently used and can be safely stored in an area subjected to heat. Temperatures may be unsafe for items, such as volatile liquids, cleaners, or aerosol sprays.

#### **About the radiant surface elements**

The temperature rises gradually and evenly. As the temperature rises, the radiant element will glow red. To maintain the selected setting, the element will cycle on and off. The heating element retains enough heat to provide a uniform and consistent heat during the off cycle. For efficient cooking, turn off the element several minutes before cooking is complete. This will allow residual heat to complete the cooking process

#### **Location of the radiant surface elements and controls:**

The radiant control knobs operate the radiant surface elements on the cooktop as shown below.

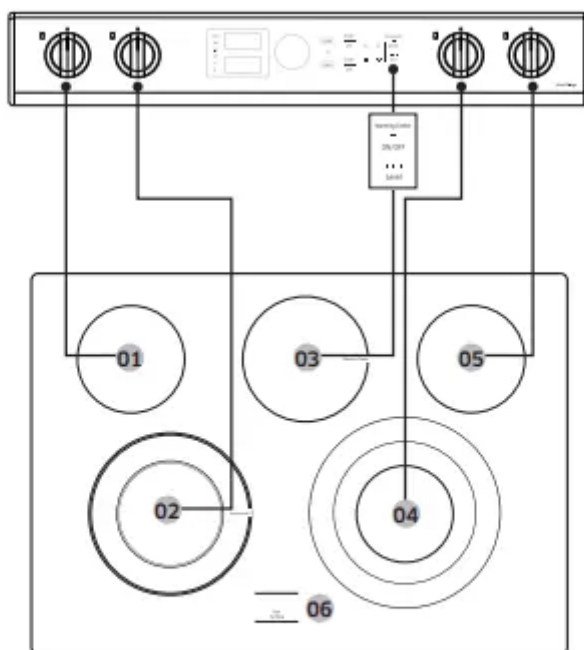

<b>01</b> Left Rear: 6", 1200 W	<b>02</b> Left Front: 6"/9", 3600 W	<b>03</b> Warming Center: 100 W
<b>04</b> Right Front: 6"/9"/12", 3000 W	<b>05</b> Right Rear: 6", 1200 W	<b>06</b> Hot surface indicator

NOTE: The knob illumination around the knob turns on when the knob is turned on.

### Hot surface indicator

- Comes on when the unit is turned on or hot to the touch.
- Stays on even after the unit is turned off.
- Glows until the unit is cooled to approximately 150 °F.

### Cooking areas

- The cooking areas on your range are identified by permanent circles on the glass cooking surface. For the most efficient cooking, fit the pan size to the element size.
- Pans should not extend more than ½" to 1" beyond the cooking area.
- When a control is turned on, you can see a glow through the glass cooking surface. The element will cycle on and off to maintain the preset heat setting, even at high settings.
- For more information on selecting proper types of cookware, refer to the section "Using the proper cookware" on page 26.

### How to set the appliance for surface cooking

#### CAUTION

- The surface elements may be hot even when off and burns can occur. Do not touch the surface elements until they have cooled down sufficiently.

- At high or medium-high settings, never leave food unattended. Boilovers cause smoking and greasy spillovers may catch on fire.
- Be sure you turn the control knob to OFF when you finish cooking

**Single surface unit control knob (Left Rear, Right Rear)**

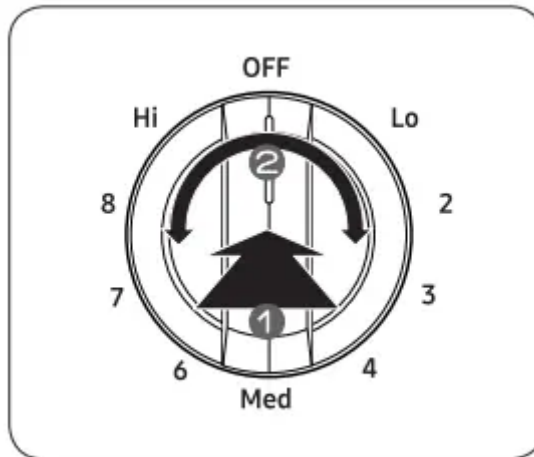

1. Push the knob in.
2. Turn in either direction to the setting you want.
  - At both the off and high settings, the knob clicks into position.

**Dual surface unit control knob (Left Front, Right Front)**

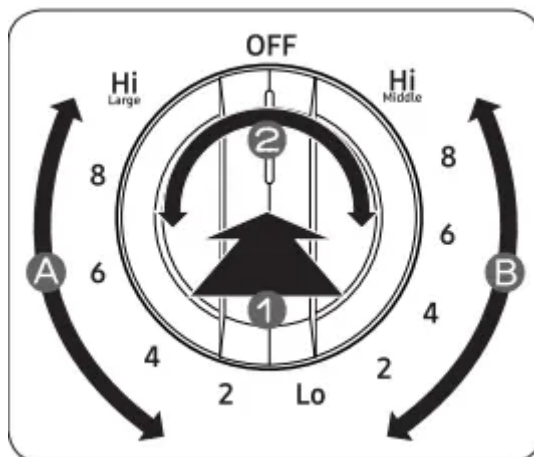

1. Push the knob in.
2. Turn in either direction to the setting you want.
  - To use the large surface unit, turn the control knob to the large burner (A) setting.
  - To use the middle surface unit, turn the control knob to the middle burner (B) setting.

**Triple surface unit control knob (Right Front)**

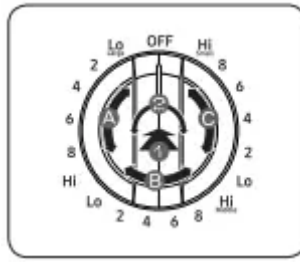

The triple surface unit has 3 cooking sizes to select from so you can match the size of the cooking area to the size of the cookware you are using.

1. Push the knob in.
2. Turn in either direction to the setting you want.
  - To use the large surface unit, turn the control knob to the large burner (A) settings
  - To use the middle surface unit, turn the control knob to the middle burner (B) settings.
  - To use the small surface unit, turn the control knob to the small burner (C) settings

### **Recommended settings**

(SETTING - TYPE OF COOKING)

- HIGH - Starting most foods, bringing water to a boil, pan broiling
- MEDIUM HIGH - Continuing a rapid boil, frying, deep fat frying
- MEDIUM - Maintaining a slow boil, thickening sauces and gravies, steaming vegetables
- MEDIUM LOW - Keeping foods cooking, poaching, stewing
- LOW - Keeping foods warm, melting, simmering

### **Using the warming center**

The warming center, located in the back center of the glass surface, will keep hot, cooked food at serving temperature.

**NOTE:** The surface warmer will not glow red like the cooking elements

### **CAUTION:**

- Do not warm food on the warming center for more than two hours.
- Use only cookware and dishes recommended as safe for oven and cooktop use.
- Always use potholders or oven mitts when removing food from the warming center as cookware and plates will be hot.
- When warming pastries and breads, use covers that have an opening to allow moisture to escape.

- Do not use plastic wrap to cover foods. Plastic may melt onto the surface and be very difficult to clean off.
- Food should be kept in its container and covered with a lid or aluminum foil to maintain food quality.
- Always start with hot food. Eating uncooked or cold food placed on the warming center could result in illness.

1. To turn the warming center on, press the Warming Center On/Off pad.
2. Select the power setting you want. Press the Warming Center Level pad once for Low, twice for Medium, or three times for High.
3. To turn the warming center off, press the Warming Center On/Off pad.

### Recommended settings

(LEVEL - TYPE OF FOOD)

- Low - Breads/pastries, casseroles, gravies, eggs
- Medium - Dinner plate with foods, soups (cream), vegetables, sauces, stews, meats
- High - Fried foods, soups (liquid), hot beverages

### Using the proper cookware

Using the right cookware can prevent many problems, such as uneven cooking or extended cooking times. Using the proper pots and pans will reduce cooking times and cook food more evenly.

Check for flatness by rotating a ruler across the bottom of the cookware.

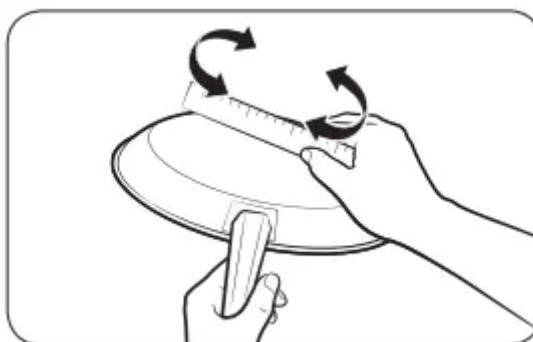

**CORRECT**

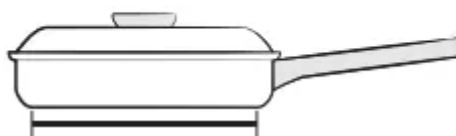

Flat bottom and straight sides.

- Tight fitting lids.

- Weight of handle does not tilt pan.
- Pan is well balanced.
- Pan size matches the amount of food to be prepared and the size of the surface element.
- Made of a material that conducts heat well.

Always match pot diameter to element surface diameter.

### INCORRECT

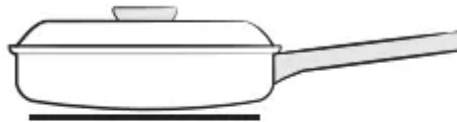

Curved and warped pan bottoms.

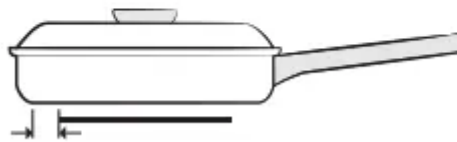

Pan overhangs element by more than one-half inch.

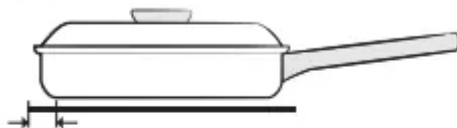

Pan is smaller than element.



Heavy handle tilts pan.

## Choosing the proper cookware

What your cookware is made of determines how evenly and quickly heat is transferred from the surface element to the pan bottom.

- **ALUMINUM** - Excellent heat conductor. Some types of food will cause the aluminum to darken. (Anodized aluminum cookware resists staining & pitting). If aluminum pans are slid across the ceramic cooktop, they may leave metal marks that resemble scratches. Remove these marks as soon as the cooktop cools down.
- **COPPER** - Excellent heat conductor but discolors easily. May leave metal marks on ceramic glass (to remove, see above.)

- **STAINLESS STEEL** - Slow heat conductor with uneven cooking results. Is durable, easy to clean, and resists staining.
- **CAST IRON** - A poor conductor; retains heat very well. Cooks evenly once cooking temperature is reached. Not recommended for use on ceramic cooktops.
- **ENAMELWARE** - Heating characteristics will vary depending on the base material. Porcelain enamel coating must be smooth to avoid scratching ceramic cooktops.
- **GLASS** - Slow heat conductor. Not recommended for ceramic cooktop surfaces because it may scratch the surface.

## Protecting the cooktop

### Cleaning

- Clean the cooktop before using it for the first time.
- Clean your cooktop daily or after each use. This will keep your cooktop looking good and can prevent damage.
- If a spillover occurs while you are cooking, immediately clean the spill from the cooking area while it is hot to prevent a tough cleaning chore later. Using extreme care, wipe the spill with a clean, dry towel.
- Do not allow spills to remain on the cooking area or the cooktop trim for a long period of time.
- Do not use abrasive cleansing powders or scouring pads, which will scratch the cooktop.
- Do not use chlorine bleach, ammonia, or other cleansers not specifically recommended for use on a glass-ceramic surface.

### Preventing marks and scratches

- Do not use glass cookware. It may scratch the cooktop.
- Do not place a trivet or wok ring between the cooktop and the pan. These items can mark or scratch the cooktop.
- Make sure the cooktop and the pan bottom are clean.
- Do not slide metal pans across the cooktop.

### Preventing stains

- Do not use a soiled dish cloth or sponge to clean the cooktop surface. A film will remain, which may cause stains on the cooking surface after the area is heated.
- Continuously cooking on a soiled surface can result in a permanent stain.

### Preventing other damage

- Do not allow plastic, sugar, or foods with high sugar content to melt onto the hot cooktop. Should this happen, clean immediately.

- Do not let a pan boil dry as this will damage the cooktop and the pan.
- Do not use the cooktop as a work surface or cutting board.
- Do not cook food directly on the cooktop. Always use the proper cookware.

## Operating the oven

### The oven control panel

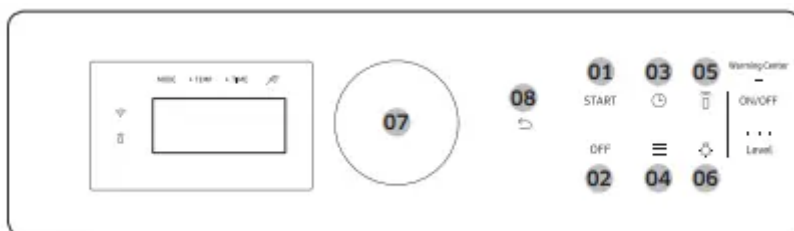

01 START: Press to start oven operation.

02 OFF: Delete all information entered, return to the first step. Stop the oven operation.

03 Time Option: Go to set time options. (Cook time, Delay start)

04 Options: Go to set options. (Timer, Cleaning, Favorite, My mode list, Lock, Screen timeout, Set time, Time format, 12hr energy saving, Sound, Sabbath, System settings)

05 Smart Control: Set Smart Control function On/Off.

06 Light: Tap to turn oven light On/Off.

07 Dial Knob: Turn Clockwise - Move focus to next / increase value.

Turn Counterclockwise - Move focus to previous / decrease value.

Push - Select the current value.

08 Back: Go to upper depth, previous page, etc.

### How to use dial knob

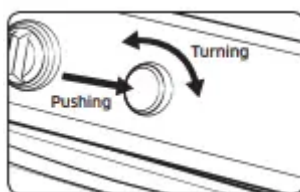

The dial knob can be used in the following ways:

#### 1. Turning

- Turning the dial knob clockwise or counterclockwise will show next or previous mode when selecting the cooking mode.

- Turning the dial knob clockwise or counterclockwise will increase or decrease the value when selecting the cooking temperature or time.

## 2. Pushing

- By pushing the dial knob, current value will be entered.

## Display mode

### Sleep mode

- The control panel enters Sleep mode if the oven is not used for a while.
- In Sleep mode, the control panel is inactive, displaying only the time, until it is reactivated by the user.

### Wake-Up

- To activate the control panel, turn or Push the Dial Knob. User preferences are available in this mode including the timer, oven light, and/or control lock.

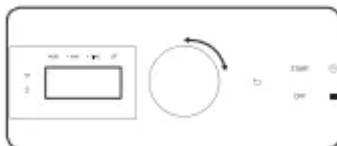

## Turning the oven light on and off

- The oven light turns on automatically when the door is opened.
- The oven light turns off automatically when the door is closed.
- You can turn the oven light on and off manually by pressing the pad.

## Clock

You must set the clock correctly to ensure the automatic features work properly.

This product supports two time formats: 12-hour (default) and 24-hour.

### To set the clock time

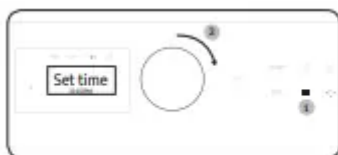

1. Tap ☰
2. Select Set time using the dial knob.
3. Enter the current time using the dial knob.
4. Push the dial knob to confirm the settings.

## To set the Date

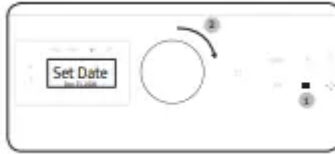

1. Tap ☰
2. Select Set Date using the dial knob.
3. Enter the current Date using the dial knob.
4. Push the dial knob to confirm the settings.

## To change the time format (12hr/24hr)

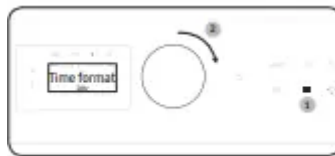

1. Tap ☰
2. Select Time format using the dial knob.
3. Turn the dial knob to select 12hr or 24 hr.
4. Push the dial knob to save the changes.

NOTE: You can set/change the clock or the kitchen timer before you start a cooking mode or while most cooking modes are operating. However, you cannot set or change the time if a time based function is operating (Time Bake, for example) or the Sabbath feature is enabled.

## Oven Cooking

STEP 1: Put all ingredients in a heat-safe container.



STEP 2: Select a cooking mode, and then start preheating.

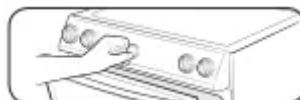

STEP 3: Place the container on a rack.



STEP 4: Close the door and start cooking.



## Cooking mode

- Make sure to close the door before you start cooking.
- If you leave the door open for about 2 minutes while the oven is in convection baking/roasting, baking, or broiling modes, the oven burner shuts off. To restart the burner, close the door.

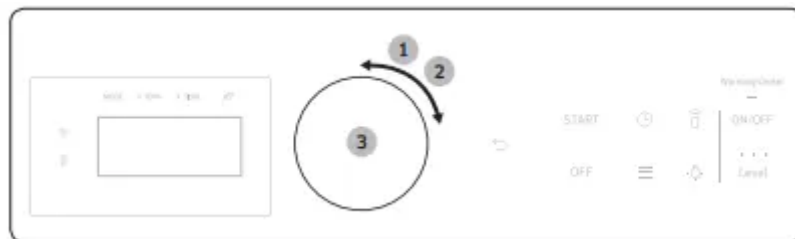

1. Use the dial knob to select a mode: Bake, Convection Bake, Convection Roast, Air Fry, Broil, etc.).
2. If necessary, use the dial knob to change the default temperature. You can set the oven to any temperature.
3. Push the dial knob, if necessary, you can set the Cook Time and Delay Start when the "Start" Message displays. Tap START or push the dial knob.
  - The oven preheats until it reaches the temperature you set.
  - It beeps several times when it reaches the set temperature.
  - When preheating is complete, place the food in the oven, and then close the door.
4. When cooking is complete, off the oven, and then take out the food.

Mode	Temperature range (°F)	Default temperature (°F)	Temp. Probe	Set Cook Time	Delay Start
Bake	175-550	350	0	0	0
Broil	Hi-Lo	Hi	X	X	X
Convection Bake	175-550	325	0	0	0
Convection Roast	175-550	325	0	0	0
Air Fry	350-500	425	X	0	0
Dehydrate	100-225	150	X	0	0
Keep Warm	-	175	X	X	X
Bread Proof	-	95	X	X	X

NOTE: To change the temperature during cooking, repeat steps 1 through 3 above.

NOTE: If the 12hr energy saving feature is disabled, those modes will operate until canceled. (12hr energy saving's default setting : on)

### Using the oven racks

Your oven range comes with 2 racks and 7 rack positions. The rack positions are delineated by rack guides which support the racks. Each rack guide has a stop that prevents the rack from loosening during the oven's operation. Each rack has stoppers that need to be placed correctly on the rack guides. The stoppers prevent the racks from accidentally coming out of the oven completely when you pull the racks out.

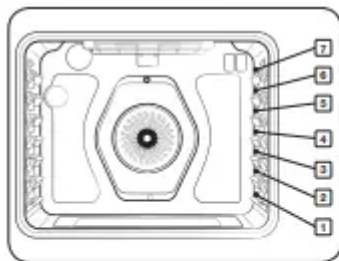

Type of food	Rack position
Broiling hamburgers	7
Broiling meats or small cuts of poultry, fish	4-6
Bundt cakes, Pound cakes, Frozen pies, Casseroles	3 or 4
Angel food cakes, Small roasts, Fresh and Frozen pizza	2
Turkey, Large roasts, Hams	1

This table is for reference only.

### CAUTION

- Do not cover an oven rack with aluminum foil. This will hamper heat circulation, resulting in poor baking.
- Do not place aluminum foil on the oven bottom. The aluminum can melt and damage the oven.
- Arrange the oven racks only when the oven is cool.
- When placing an oven rack in the top-most rack position (position 7), make sure the rack is situated stably on the embossed stop

## Inserting and removing an oven rack

To insert an oven rack

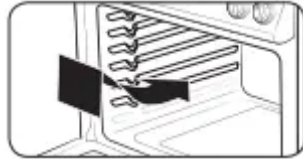

1. Place the rear end of the rack on a rack guide.
2. Slide the rack into the rack guide while holding the front end of the rack.

To remove an oven rack



1. Pull out the rack until it stops.
2. Pull up the front end of the rack and remove it from the rack guide.

## Rack and Pan placement

Centering the baking pans in the oven as much as possible will produce better results. If baking with more than one pan, place the pans so each has at least 1" to 1½" of air space around it.

When baking on a single oven rack, place the oven rack in position 3 or 4. See the figure on the left.

When baking cakes and cookies on multiple racks, place the oven racks in positions 3 and 5. See the figure on the left. Cookies place the racks in positions 2 and 5

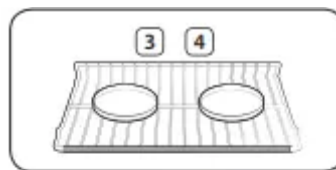

Single Oven Rack

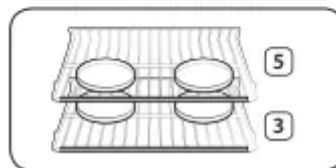
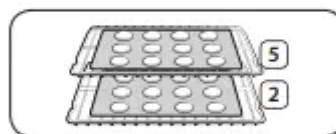

Multiple Oven Rack

## Using Multiple Oven Racks

Type of Baking	Rack Positions
Cookies	2 and 5
Cakes	3 and 5

### Before using the racks

The oven has two racks.

Each rack has stops that need to be placed correctly on the supports. These stops will keep the rack from coming completely out.

### REMOVING THE RACKS

1. Pull the rack straight out until it stops.
2. Lift up the front of the rack, and then pull it out.

### REPLACING THE RACKS

1. Place the end of the rack on the support.
2. Tilt the front end up and push the rack in.

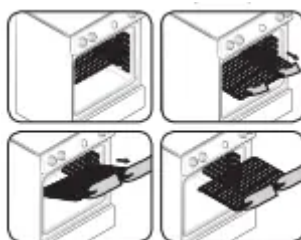

### CAUTION

- Do not cover a rack with aluminum foil or place aluminum foil on the oven bottom. This will hamper heat circulation, resulting in poor baking, and may damage the oven bottom.
- Arrange the oven racks only when the oven is cool.

### Recipe guide



### CAUTION

- Always use this cooking mode with the oven door closed.
- Use care when opening the door. Let hot air or steam escape before you remove food from or put food into the oven.

### Baking:

Bake is used to cook cakes, cookies, and casseroles. Always preheat the oven first. Baking temperatures and times will vary depending on the ingredients and the size and shape of the baking pan used. Dark or nonstick coatings may cook faster with more browning.

#### NOTE

- Place food in the oven after preheating if the recipe calls for it.
- Preheating is very important for good results when baking cakes, cookies, pastry, and breads. After the oven has reached the desired temperature, the oven will beep several times.
- If you are using an oven thermometer in the oven cavity, the temperature registered by the thermometer may differ from the actual set oven temperature.
- For performance reasons, the convection fan may be turned on or off during the operation.

#### Convection cooking:

The convection fan at the back of the oven circulates hot air evenly throughout the oven cavities so that food is evenly cooked and browned in less time than with regular heat

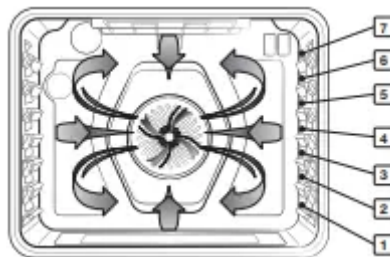

#### Convection baking:

- Ideal for foods being cooked using multiple racks.
- Good for large quantities of food.
- Provides the best performance for cookies, biscuits, brownies, cupcakes, cream puffs, sweet rolls, angel food cake, and bread.
- Cookies bake best when cooked on flat cookie sheets.
- When convection baking using a single rack, place the rack in rack position 3 or 4. (In Twin mode, position A or 1.)
- When convection baking using two racks, place the racks in positions 3 and 5 (Cakes, Cookies).
- The oven automatically adjusts the temperature for convection baking.

#### Convection roasting

- Good for larger, tender cuts of meat, uncovered.

- For best performance, place a broiler pan and grid under the meat or poultry. The pan catches grease spills and the grid prevents grease spatters.
- Heated air circulates over, under, and around the food. Meat and poultry are browned on all sides as if they were cooked on a rotisserie.

## Broiling

Broiling uses the oven broil burner at the top of the oven to cook and brown food. Meat or fish must be put on a broiling grid in a broiling pan. Preheating for minutes before broiling is recommended.

### NOTE

- This oven is designed for closed door broiling. While broiling, keep the door closed.
- Only open the door to put food in, turn food over, or take food out.
- Use the Broil Rack for the best results.
- Use the Broil LO for poultry or thick cuts of meat to prevent overbroiling.
- Use caution when you open the oven door to turn over the food. The air escaping from the oven will be very hot.
- If you leave the oven door open for more than 2 minutes when the oven is on, all heating elements will shut off automatically.
- When you have finished cooking, the cooling fan will continue to run until the oven has cooled down.

## Broiling guide:

### NOTE

- This is for reference only.
- Preheating for 4 minutes before broiling is recommended.
- The size, weight, thickness, starting temperature, and your doneness preference will affect broiling times.
- This guide is based on meats at refrigerator temperature.

Food	Doneness	Size	Thickness	Broil setting	Rack position	Cooking time	
						1st side	2nd side
Hamburgers	Medium	9 patties	1"	HI	7	3:20-3:40	2:20-2:40
Beef steak	Medium	-	1"	HI	5	7:00-8:00	6:00-7:00
	Medium	-	¾"	HI	5	6:00-7:00	5:00-6:00
Chicken pieces	Well done	2-2½ lbs.	¾"-1"	HI	4	15:00-16:00	13:00-14:00
Pork chops	Well done	1 lb.	½"	LO	5	15:00-16:00	13:00-14:00
Lamb chops	Well done	1 lb.	¾"-1"	HI	5	5:00-6:00	4:00-5:00
Salmon steak	Well done	3 pcs.	¾"-1"	HI	5	4:00-7:00	3:00-6:00

## Air fry:

This feature uses hot air for crispier and healthier frozen or fresh foods without or less oil than normal convection modes. For best results, use this mode on a single oven rack and place the Air fry tray on the position 3. The temperature can be set between 350 °F and 500 °F. Preheating is not necessary for this mode. Follow recipe or package directions for set temperature, time or quantity. How to set the oven for Air fry mode

1. Place the tray on rack position 3.
2. Select Air fry mode using the dial knob.
3. Use the dial knob to change the default temperature. Enter the suggested temperature for your food as recommended cooking guide. The default temperature is 425 °F.
4. Push the dial knob and set the Cook Time or Delay Start, if necessary.
5. Tap START or push the dial knob.
6. When cooking is complete, tap OFF and take out the food

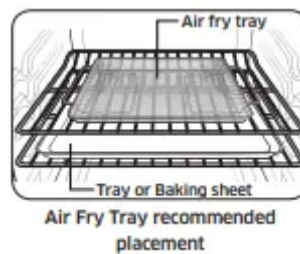

#### NOTE

- Place a baking sheet or tray on the rack below the Air fry tray for getting any drippings. This will help to reduce splatter and smoke.
- Before using a baking sheet, check the maximum allowable temperature of baking sheet.
- Air fry is designed for a single oven rack. Place food on rack position 3 for best results.
- For cooking fresh or homemade foods, spread the oil over a larger area more evenly, crisping up the food more effectively.

#### Air fry cooking guide

Item	Amount	Temperature	Time
<b>Potatoes</b>			
Frozen French Fries	30-35 oz	425 °F-450 °F	25-30 min
Frozen French Fries, Seasoned	25-30 oz	425 °F-450 °F	20-25 min
Frozen Tater Tots	40-45 oz	450 °F	20-25 min
Frozen Hash Brown	25-30 oz	425 °F-450 °F	20-25 min
Frozen Potato Wedges	30-35 oz	425 °F-450 °F	20-25 min
Homemade French Fries	25-30 oz	400 °F-425 °F	25-30 min
Homemade Potato Wedges	40-45 oz	425 °F-450 °F	25-30 min
<b>Frozen</b>			
Frozen Chicken Nuggets	24-28 oz	400 °F-425 °F	15-25 min
Frozen Chicken Wings	30-35 oz	425 °F-450 °F	20-30 min
Frozen Onion Rings	20-25 oz	400 °F-425 °F	15-20 min
Frozen Fish Fingers	20-25 oz	425 °F	18-22 min
Frozen Chicken Strips	25-30 oz	425 °F-450 °F	20-30 min
Frozen Churros	20-25 oz	425 °F	18-22 min

<b>Poultry</b>			
Fresh Drumsticks	40-45 oz	425 °F-450 °F	30-35 min
Fresh Chicken Wings	30-35 oz	425 °F-450 °F	27-32 min
Chicken Breasts, Breaded	25-30 oz	450 °F	25-30 min
<b>Vegetables</b>			
Asparagus, Breaded	15-20 oz	425 °F	20-25 min
Egg Plants, Breaded	20-25 oz	425 °F	20-25 min
Mushroom, Breaded	18-22 oz	425 °F	20-25 min
Onions, Breaded	18-22 oz	425 °F	20-25 min
Cauliflowers, Breaded	40-45 oz	400 °F-425 °F	20-25 min
Vegetable Mix, Breaded	30-35 oz	425 °F	20-25 min

## **Dehydrate**

Dehydrate dries food or removes moisture from food via heat circulation. After drying the food, keep it in a cool and dry place. For fruit, adding lemon (or pineapple) juice or sprinkling sugar on the fruit helps the fruit retain sweetness.

- NOTE
  - There is no preheating before dehydrating.
  - Place the rack in rack position 3 or 4.

## **Bread Proof**

The Bread Proof function automatically provides the optimum temperature for the bread proof process and, therefore does not have a temperature adjustment.

If you press Bread Proof when the oven temperature is above 95 °F, Hot will appear in the display. Because these functions produce the best results when started while the oven is cool, we recommend that you wait until the oven has cooled down and Hot disappears from the display.

### **NOTE**

- There is no preheating before bread proof.
- Place the rack in rack position 3.

## **Keep Warm:**

Keeps cooked food warm at a low temperature up to 3 hours

## **Temperature probe**

The temperature probe lets you cook roasts and poultry to the exact internal temperature you want, taking the guess work out of determining whether a piece of meat is done or not.

You can use the temperature probe with the oven set to Bake, Convection Bake, or Convection Roast. When you use the temperature probe, the internal temperature is shown on the display when it reaches 100 °F.

1. Push the temperature probe into the meat so that the tip of the probe reaches the center of the meat.

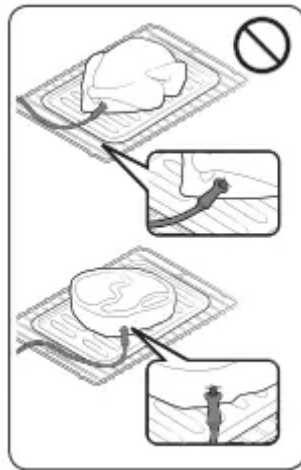

- When you insert the temperature probe, make sure it does not contact bone, fat, or gristle.
- For bone-in meats, insert the probe into the center of the lowest and thickest portion of the piece.
- For whole poultry (turkey, large chickens, etc.), insert the probe into the thickest part of the inner thigh, parallel to the leg.
- If you remove the temperature probe while cooking is in process, the oven shuts off in 60 seconds.
- The temperature probe may not function properly if inserted into frozen food. (The temperature probe icon doesn't appear.)

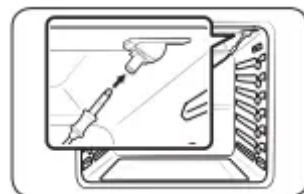

2. Insert the temperature probe plug into the socket on the top side wall of the oven.
3. Select the cooking operation (Convection Bake, Convection Roast, or Bake) and the temperature.
4. Set the internal temperature between 100 °F to 200 °F using the dial knob.

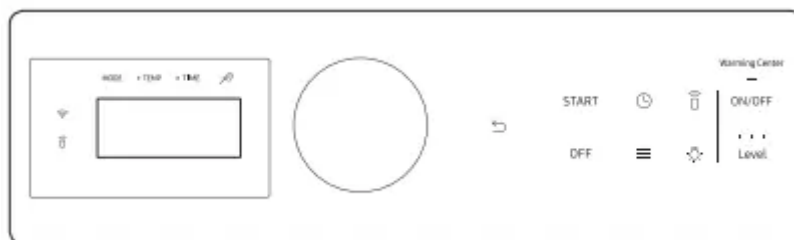

5. Set an option (Cooking Time, Delay Start, or Keep Warm) if necessary.

6. Tap START. When the food reaches the set internal temperature, the oven automatically shuts off, and then beeps.

NOTE: Temperature probe operation will shut off either :

- When cooking time is over.
- When the temperature reaches the temperature you set.

### Temperature table

Type of Food		Internal temperature (°F)
Beef / Lamb	Rare	140-150
	Medium	160-170
	Well done	170-180
Pork		170-180
Poultry		165-185

### Cooking options

CAUTION: Food that can easily spoil, such as milk, eggs, fish, poultry, and meat, should be chilled in a refrigerator before they are placed in the oven. Even when chilled, they should not stand for more than 1 hour before cooking begins and should be removed promptly when cooking is completed.

#### Cook Time:

Timed cooking sets the oven to cook foods at a set temperature for a set length of time. The oven automatically turns off when it finishes.

Mode: Bake / Convection Bake / Convection Roast / Air Fry / Dehydrate

1. Start a desired cooking mode, such as Bake.
2. If necessary, change the temperature using the dial knob.
3. When "Start" displays, select Set Cook Time using the dial knob.
4. Set the cooking time between 1 minute and 9 hours and 59 minutes (9:59) using the dial knob.
5. Use the dial knob to select one of the following options you want to run at the end of cooking.
  - Oven Off: The oven turns off at the end of cooking. (Default setting)
  - Keep temp: Keep running the oven at the current cooking temperature at the end of cooking.
  - Keep warm: Activate Keep warm function at the end of cooking.
6. Tap "START". The oven will automatically turn on and start preheating. The temperature will increase until it reaches the temperature you set. The oven starts cooking for the amount of time you set.

7. When preheating is complete, put the container with the food on a rack, and then close the door.
8. When the cooking time has elapsed, the oven will automatically shut off and then beep.

### **Delay Start:**

The Delay Start function lets you use the kitchen timer to automatically start and stop another cooking program. You can set Delay Start so that it delays the automatic start of a cooking operation you select by up to 12 hours.

Mode: Bake / Convection Bake / Convection Roast / Air Fry / Dehydrate / Self-clean

1. Place the container with the food on a rack, and then close the door.
2. Start a desired cooking mode, such as Bake.
3. If necessary, change the temperature using the dial knob.
4. When "Start" displays, select Set Delay Start using the dial knob.
5. Set the starting time using the dial knob.
6. When "Delay Start" displays, press START or push the dial knob to start.
7. The oven starts cooking at the set time.

NOTE: To change the starting time, press the  , or use the dial knob.

## **Special features**

### **The Sabbath feature**





(For use on the Jewish Sabbath and Holidays) Use this option only for baking on the Jewish Sabbath and Holidays.

### **With the Sabbath feature**

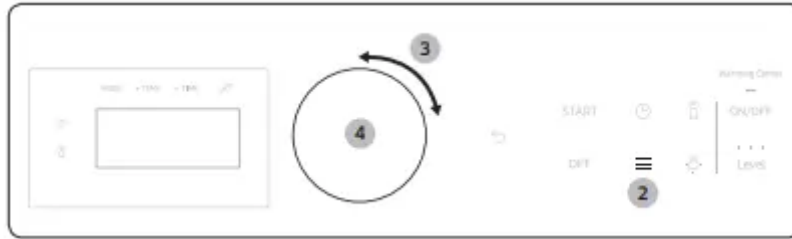

- The oven temperature can be set higher or lower after you have set this option.
- The display doesn't change and no beep sounds when you change the temperature.
- Once the oven is properly set for baking with the Sabbath feature active, the oven will remain continuously on until the Sabbath feature is cancelled. This will override the factory preset 12 hour energy saving feature.
- If the oven light is needed during the Sabbath, press the  pad before activating the Sabbath feature. Once the oven light is turned on and the Sabbath feature is active, the oven light will remain on until the Sabbath feature is turned off.
- If you want the oven light off, be sure to turn it off before activating the Sabbath feature.
- Do not use the surface cooktop when the Sabbath feature is on.

## To enable the Sabbath feature



1. Start a Bake Mode.
2. Tap , and select the Sabbath feature.
3. Turn the dial knob to select On/Off.
4. Push the dial knob to save the changes.

### NOTE

- You can change the oven temperature once baking starts, but the display will not change or beep. After changing the temperature, it takes 15 seconds before the oven recognizes the change.
- You can turn off the oven at any time by tapping OFF. However, this doesn't deactivate the Sabbath feature.
- To deactivate the Sabbath feature, hold down  for 3 seconds.
- You can set the cooking time before activating the Sabbath feature.
- After a power failure, the oven will not resume operation automatically. "Sabbath" will appear in the control panel, but the oven will not go back on. Food can be safely removed from the oven, but you should not turn off the Sabbath feature and turn the oven back on until after the Sabbath/Holidays.
- After the Sabbath observance, turn off the Sabbath feature by pressing and holding  for at least 3 seconds.

## More functions

Tap the  button on the control panel, and then turn the dial knob to change various settings for your oven. Please refer to the following table for detailed descriptions.

The Options menu is available only when the oven is off.

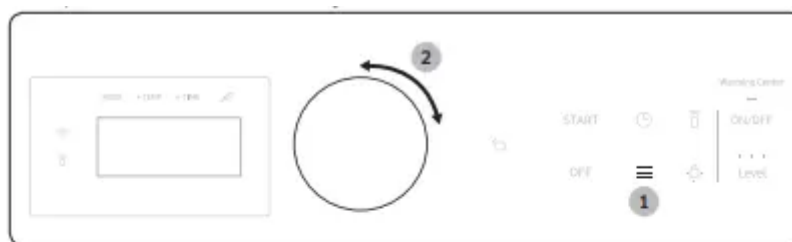

Setting	Description
Timer	Set the timer.
Cleaning	Burn off leftover grease and residue completely or reduce them. <b>NOTE</b> See page 46.
Favorite	Save the cooking mode and value frequently used.
My Mode List	Edit cooking mode list.
Lock	Lock the control panel and the door.
Auto Conversion	Automatically lower the temperature by 25 °F (15 °C) when using Convection Bake.

Setting	Description
Screen Timeout	Adjust the display timeout.
Set time	Set the clock to display the current time. <b>NOTE</b> See page 29.
Set Date	Set the clock to display the current date. <b>NOTE</b> See page 29.
Time format	Set the clock to display the time in the 12-hour or 24-hour format. <b>NOTE</b> See page 29.
12hr energy saving	Automatically turns off the oven 12 hours after baking starts or 3 hours after broiling starts.
Sound	Turn the oven's sound (beeps) on or off.
Sabbath	Setting Sabbath mode. ON/Off. <b>NOTE</b> See page 40.

## Timer

The timer gives you an extra timer you can use to time cooking tasks, such as boiling eggs. It does not, however, start or stop any cooking operation. You can set the timer from 1 minute to 9 hours and 59 minutes.

1. Tap To select Timer using the dial knob.
2. Enter a desired time using the dial knob.
3. When done, push the dial knob.
4. To cancel the Timer settings, push or turn the dial knob. To select cancel using the dial knob.

5. When the set time elapses, the oven beeps and displays the "Time is up." message.  
Count up timer starts after finishing Timer, it lasts for only mins. Push or turn dial knob, or tap back, count up timer will timer will be disappeared.

### **Favorite**

You can add up to 10 frequently used cook settings to the Favorites list to easily apply them in the future.

Adding the new cook settings to the Favorites

1. Tap  and select Favorite using the dial knob.
2. Set the cook setting (Mode, Temperature, Cook Time, Probe Temp).
3. If necessary, select option (Cook Time and Probe Temp).

### **Editing the favorite cook settings**

1. Tap  and select Favorite using the dial knob.
2. Select Edit.
3. Change the cook settings. Items appear on the list may change upon what you select. (Cook mode, temperature, Cook Time, etc.)

### **Deleting the favorite cook settings**

1. Tap  and select Favorite using the dial knob.
2. Select Delete.
3. Select the favorite cook setting you want to delete.

### **Using the favorite cook settings**



1. To select Favorite Mode using the dial knob.
2. Select the favorite cook setting you want to start.
3. Tap START.

### **My Mode List:**

You can edit the mode lists.

1. Tap  and select My Mode List using the dial knob.
2. Turn the dial knob to select or unselect modes.
3. Select Save to save the changes.

### **Lock**

- Lock the control panel and the door to prevent accidental operations or product tipping.
- Tap  and select Lock using the dial knob to lock both the control panel and the door.  
When the Oven Lock is on, the oven panel does not operate and the oven door is locked and cannot be opened. Tap and hold  for 3 sec to unlock the oven.

### **Auto Conversion:**

Auto Conversion automatically converts regular baking temperatures to convection baking temperatures. For example, if you enter a regular recipe temperature of 350 °F and tap START, the oven displays the converted temperature of 325 °F.

1. Tap  and select Auto Conversion using the dial knob.
2. Turn the dial knob to select On/Off. (Default setting is "Off".)
3. Push the dial knob to save the changes

### **Screen Timeout:**

You can set the length of time before the screen saver turns on.

1. Tap  and select Screen Timeout using the dial knob.
2. Turn the dial knob to select setting time.
3. Push the dial knob to save the changes.

#### **NOTE:**

- Energy consumption may increase depending on your setting.
- When the timeout setting is set to "Always on", the brightness of the LCD automatically changes to level 2 if there is no action for 3 minutes.

### **12hr energy saving:**

This will automatically turn off the oven 12 hours after baking starts or 3 hours after broiling starts.

1. Tap  and select 12hr energy saving using the dial knob.
2. Turn the dial knob to select On/Off.
3. Push the dial knob to save the changes.

### **Sound:**

Turn sound (beeps) On/Off.

1. Tap  and select Sound using the dial knob.
2. Turn the dial knob to select On/Off.
3. Push the dial knob to save the changes.

### **System Settings**

Tap and hold  for 3 sec, on the control panel, and then Turn the dial knob to change various settings for your oven. Please refer to the following table for detailed descriptions.

System Setting	Description
Wi-Fi	Set the WI-FI mode to On/Off.  <b>NOTE</b> See page 46.
Language	Select a preferred language from English, French, or Spanish.
Temp. Unit	Set the oven control to display temperatures in Fahrenheit or Centigrade.
Calibrate Temp	Recalibrate the oven temperature.
My Pattern	This function remembers and stores the cook settings.
Welcome Lighting	Set the Welcome Lighting mode to On/Off.
Demo mode	Used by retailers for display purposes only.
Reset	Reset the your setting. (More Functions, System settings)

### Language:

Select a preferred language from English, French, or Spanish. You can not change the language during cooking.

1. Tap and hold  for 3 sec.
2. Select the Language using the dial knob.
3. Turn the dial knob to select the Language and push to save the changes.

### Temp. Unit (°F / °C):

Change the temperature format of the oven to Fahrenheit or Centigrade. The default is Fahrenheit.

1. Tap and hold  for 3 sec.
2. Select Temp. Unit using the dial knob.
3. Turn the dial knob to select unit and push to save the changes.

### Calibrate Temp:

The oven temperature has been calibrated at the factory. When first using the oven, follow the recommended recipe times and temperatures. If it appears that the oven is too hot or too cool, you can recalibrate the oven temperature. Before recalibrating, test a recipe by using a temperature setting that is higher or lower than recommended. The baking results should help you decide how much of an adjustment is needed. The oven temperature can be adjusted by  $\pm 35$  °F ( $\pm 19$  °C).

1. Tap and hold  for 3 sec.
2. Select Calibrate Temp using the dial knob.
3. Turn the dial knob to adjust temperature value.
4. Push the dial knob to save the changes.

NOTE: This adjustment does not affect the broiling or the self-cleaning temperature, and is retained in memory after a power failure.

### **My Pattern:**

This function remembers and stores the cook settings frequently used by the user.

1. Tap and hold  for 3 sec.
2. Select My Pattern using the dial knob.
3. Turn the dial knob to select On/Off and push to save the changes.

### **Welcome Lighting:**

When you wake up the oven (such as using the dial knob, using the touch pad, open the door), the knob lights blink each to welcome you. Set the Welcome Lighting mode to On/Off. The default is on.

1. Tap and hold  for 3 sec.
2. Select Welcome Lighting using the dial knob.
3. Turn the dial knob to select On/Off and push to save the changes.

### **Demo mode:**

This is used by retailers for display purposes only. In this mode, the heating element does not operate.

1. Tap and hold for  3 sec.
2. Select Demo mode using the dial knob.
3. Turn the dial knob to select On/Off and push to save the changes.

### **Reset:**

You can reset your oven setting(More functions, System settings).

1. Tap and hold  for 3 sec.
2. Select Reset using the dial knob.
3. Turn the dial knob to select Cancel/Reset

## **Smart control**

### **How to connect the oven**

1. Download and open the SmartThings app on your smart device.
2. Follow the app's on-screen instructions to connect your range.
3. Once the process is complete, the connected  icon located on your range displays and the app will confirm you are connected.
4. If the connection icon does not turn on, follow the instruction on the app to reconnect.



### To control the oven remotely

1. Press Smart Control  appears in the display. The oven can now be controlled remotely with a connected remote device.
2. Select the oven icon on the SmartThings app to open the Oven Control app. When the app is connected to the oven, you can perform the following functions through the application:

#### Oven remote control using the SmartThings app

- Oven/ Cooktop Monitoring
  - Check the status of the oven
  - Monitor the on/off status of each cooktop burner.
- Oven Remote Control
  - Set or adjust oven settings remotely.
- My Cooking
  - Turn the oven off remotely.
  - Once cooking starts, change the set cooking time and temperature remotely.
- Error Check
  - Automatically recognize errors. Temp. Probe
  - Monitor the current temperature and reset the probe setting.

If  is not shown in the display, you are still able to monitor the oven and cooktop status and turn the oven off.

#### WI-FI On/Off:

If you set the WI-FI mode to Off, mobile devices cannot connect to the range.

1. Tap and hold for 3 sec.
2. Select Wi-Fi mode using the dial knob.
3. Turn the dial knob to select On/Off and push to save the changes.

#### NOTE

- Pressing Smart Control will delete  from the display and prevent most of the remote functions from operating.

- When oven cooking is finished or cancelled , is removed from the display.
- For safety reasons, you must specify the cooking time to enable remote control.
- The oven continues operating even if the Wi-Fi connection is lost.
- Smart Control will not work properly if the Wi-Fi Connection is unstable.
- See the SmartThings app manual for detailed information

## Maintaining your appliance

### Self-cleaning

This self-cleaning oven uses high temperatures (well above cooking temperatures) to burn off leftover grease and residue completely or reduce them to a finely powdered ash that you can wipe away with a damp cloth.

#### **CAUTION:**

- During the self-cleaning cycle, the outside of the range will become very hot to the touch. Do not leave small children unattended near the appliance.
- Some birds are extremely sensitive to the fumes given off during the selfcleaning cycle of any range. Move birds to another well-ventilated room.
- Do not line the oven walls, racks, bottom, or any other part of the range with aluminum foil. Doing so will result in poor heat distribution, poor baking results, and cause permanent damage to the oven interior. Aluminum foil will melt and adhere to the interior surface of the oven.
- Do not force the oven door open. This can damage the automatic door locking system. Use care when opening the oven door after the self-cleaning cycle is complete. Stand to the side of the oven when opening the door to allow hot air or steam to escape. The oven may still be VERY HOT.

### Before a self-cleaning cycle

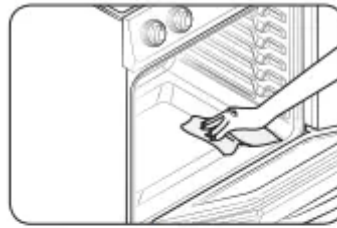

Fig. 1

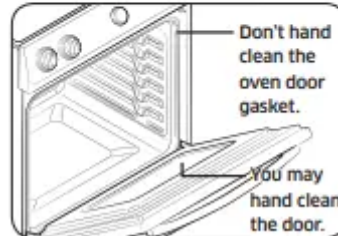



Fig. 2

- We recommend venting your kitchen with an open window or using a ventilation fan or hood during the selfcleaning cycle.
- Remove the wire rack, broil pan, broil pan insert, all cookware, and any aluminum foil from the oven.
- Wipe up debris from the oven bottom. (Fig.1)
- The silver-colored oven racks can be self-cleaned, but they will darken, lose their luster, and become hard to slide.
- Residue on the front frame of the range and outside the gasket on the door will need to be cleaned by hand. Clean these areas with hot water, soap-filled steel-wool pads, or cleansers, such as Soft Scrub. Rinse well with clean water and dry.
- Do not clean the gasket. The fiberglass material of the oven door gasket cannot withstand abrasion. It is essential for the gasket to remain intact. If you notice it becoming worn or frayed, have it replaced. (Fig.2)
- Make sure the oven light bulb cover is in place and the oven light is off.

### How to run a self-cleaning cycle

1. Make sure the oven door is closed completely and unlocked. And turn off all oven and cooktop function.
2. Tap  and select Cleaning > Self Clean using the dial knob. Then, select the cleaning time. (2 hour / 3 hour / 5 hour)
3. Tap START/SET. The oven door is locked automatically and the oven begins to heat up.

### NOTE

- You will not be able to start a self-cleaning cycle if the oven lock feature is activated or if the oven's temperature is too hot.

- The oven door locks automatically. The display will show the cleaning time remaining. It is not possible to open the oven door until the temperature drops to a safe/cool temperature.
- The self-cleaning feature will not operate when the warming center is on.

4. When the self-cleaning cycle is done, End will appear in the display and the range will beep several times.

#### **How to delay the start of self-cleaning**

1. Repeat steps 1 and 2 on 'How to run a self-cleaning cycle'.
2. Select Set Delay Start.
3. Set the time you want the oven to start self-cleaning using the dial knob.
4. Tap START/SET.

The oven will start self-cleaning at your specified time.

#### **How to turn off the self-cleaning feature**

You may find it necessary to stop or interrupt a self-cleaning cycle due to smoke in the oven.

1. Press OFF
2. You will be able to open the oven door once the oven has cooled down for approximately 1 hour.

#### **After a self-cleaning cycle**

- You may notice some white ash in the oven. Wipe it up with a damp cloth after the oven cools. (If white spots remain, remove them with a soap-filled steel wool pad and rinse thoroughly with a vinegar and water mixture).
- If the oven is not clean after one cycle, repeat the cycle.
- You cannot set the oven for cooking until the oven is cool enough for the door to unlock.

### **Steam-cleaning**

#### **How to set the oven for steam-cleaning:**

For light cleaning, the steam-cleaning function saves time and energy. For heavier duty cleaning, use the self-cleaning function.

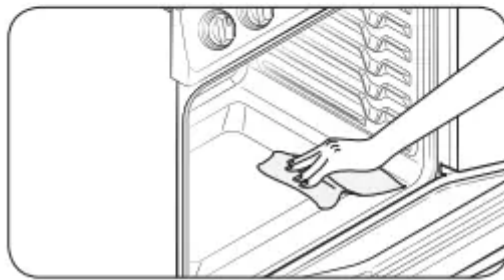
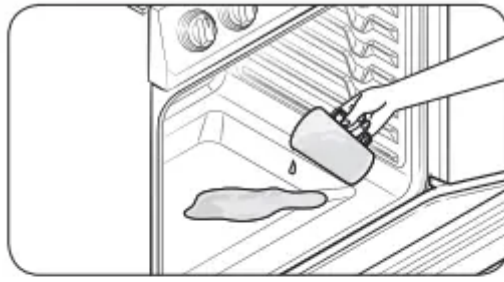

1. Remove all accessories from the oven.
2. Pour approximately 10 oz. (300 ml) of water onto the bottom of the empty oven and then close the oven door. Use normal water only, not distilled water.
3. Tap  $\equiv$  and select Cleaning > Steam Clean using the dial knob.
4. Tap START/SET. The oven door is locked automatically and the oven begins to heat up. When the operation is complete, the display will blink and a beep will sound.
5. Press OFF.
6. Clean the oven's interior. There will be a significant amount of water remaining on the bottom of the oven after a steam-cleaning cycle. Remove the residual water with a sponge or soft dry cloth

#### **After a steam-cleaning cycle**

- Take care when opening the door before a steam-cleaning procedure has ended. The water on the bottom is hot.
- Open the oven door and remove the remaining water with a sponge. Do not leave the residual water in the oven for any length of time. Wipe the oven clean and dry with a soft cloth. Do not forget to wipe under the oven door seal.
- Use a detergent-soaked sponge, a soft brush, or a nylon scrubber to wipe the oven interior. Remove stubborn residue with a nylon scourer. You can remove lime deposits with a cloth soaked in vinegar.
- If the oven remains dirty, you can repeat the procedure once the oven has cooled.

- For heavy residue, such as grease left over from roasting, we recommend that you rub detergent into the residue before activating the steam-cleaning function.
- After cleaning, leave the oven door ajar at a 15° angle to allow the interior enamel surface to dry thoroughly

## Care and cleaning of the oven

### Vent

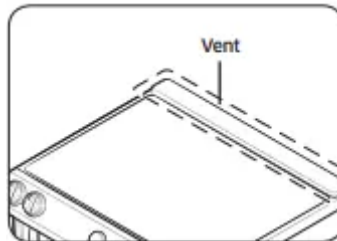

- The cooling vents are located at the back of the oven range.
- This area could become hot during oven use.
- It is normal for steam to come out of the vent.
- The vent is important for proper air circulation. Never block this vent.

### Cleaning painted parts and decorative trim

- For general cleaning, use a cloth with hot, soapy water.
- For more difficult residue and built-up grease, apply a liquid detergent directly onto the area and leave for 30 to 60 minutes. Wipe with a damp cloth and dry. Do not use abrasive cleaners on any of these surfaces. They can scratch.

### Cleaning stainless steel surfaces

1. Shake the bottle of Stainless Steel Appliance Cleaner or Polish well.
2. Place a small amount of Stainless Steel Appliance Cleaner or Polish on a damp cloth or damp paper towel.
3. Clean a small area, rubbing with the grain of the stainless steel if applicable.
4. Dry and buff with a clean, dry paper towel or soft cloth.
5. Repeat as necessary

### Oven racks

- If the racks are left in the oven during a self-cleaning cycle, their color will turn slightly blue and the finish will be dull. After the self-cleaning cycle is complete and the oven has cooled, rub the sides of the racks with wax paper or a cloth containing a small amount of oil. This will help the racks glide more easily on their tracks.
- Gliding racks may be cleaned by hand with an abrasive cleaner or steel wool. During cleaning, be careful not to allow water or cleaner to enter the slides on the sides of rack

## Air fry tray

To keep the Air fry tray clean, remove them from the cavity, and soak them in Lukewarm soapy water. Then, scour soil off of the Air fry tray using a plastic scouring pad.

NOTE: The air fry tray is dishwasher-safe.

CAUTION: Do not leave the air fry tray in the oven during the self-cleaning cycle. The extreme heat generated in this cycle can permanently peel off the air fry coating, their color will turn slightly blue and finish will be dull.

## Oven door

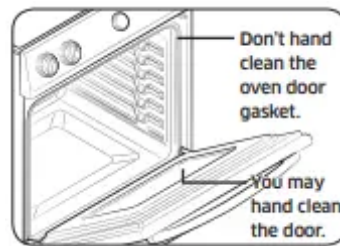

- Use soap and water to thoroughly clean the top, sides, and front of the oven door. Rinse well. You may use a glass cleaner on the outside glass of the oven door. DO NOT immerse the door in water. DO NOT spray or allow water or the glass cleaner to enter the door vents. DO NOT use oven cleaners, cleaning powders, or any harsh abrasive cleaning materials on the outside of the oven door.
- DO NOT clean the oven door gasket. The oven door gasket is made of a woven material, which is essential for a good seal. Care should be taken not to rub, damage, or remove this gasket.

## Care and cleaning of the glass cooktop

### Normal daily use cleaning :

Use only a ceramic cooktop cleaner. Other creams may not be as effective. By following these steps, you can maintain and protect the surface of your glass cooktop.

1. Before using the cooktop for the first time, clean it with a ceramic cooktop cleaner. This helps protect the top and makes cleanup easier.
2. Daily use of a ceramic cooktop cleaner will help keep the cooktop looking new.
3. Shake the cleaning cream well. Apply a few drops of cleaner directly to the cooktop.
4. Use a paper towel or a cleaning pad for ceramic cooktops to clean the entire cooktop surface.
5. Use a dry cloth or paper towel to remove all cleaning residue. No need to rinse.

### Removing burned-on residue

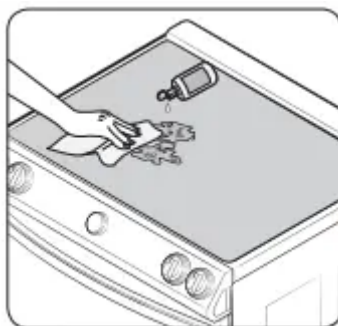

1. Allow the cooktop to cool.
2. Spread a few drops of ceramic cooktop cleaner on the entire burned residue area.
3. Using a cleaning pad for ceramic cooktops, rub the residue area, applying pressure as needed.
4. If any residue remains, repeat the steps listed above as needed.
5. For additional protection, after all residue has been removed, polish the entire surface by applying ceramic cooktop cleaner with a paper towel.

#### **Removing heavy, burned-on residue**

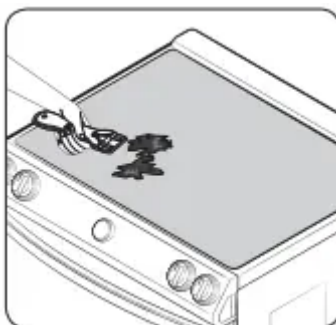

1. Allow the cooktop to cool.
2. Use a single-edge razor-blade scraper at approximately a 45° angle against the glass surface and scrape the soil. It will be necessary to apply pressure to remove the residue.
3. After scraping with the razor scraper, spread a few drops of ceramic cooktop cleaner on the entire burned residue area. Use a cleaning pad to remove any remaining residue. (Do not scrape the seal.)
4. For additional protection, after all residue has been removed, polish the entire surface by applying ceramic cooktop cleaner with a paper towel.

#### **Removing metal marks and scratches**

1. Be careful not to slide pots and pans across your cooktop. It will leave marks on the cooktop surface. You can remove these marks by applying ceramic cooktop cleaner with a cleaning pad for ceramic cooktops.

2. If pots with a thin overlay of aluminum or copper are allowed to boil dry, the overlay may leave black discoloration on the cooktop. You should remove this discoloration immediately or it may become permanent.

### **Cleaning the cooktop seal**

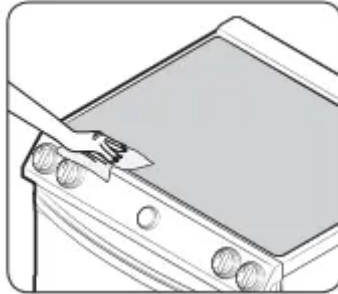

To clean the seal around the edges of the glass, lay a wet cloth on it for a few minutes, then wipe clean with a nonabrasive cleaner.

### **Potential for permanent damage to the glass surface**

- Sugary spillovers (such as jellies, fudge, candy, syrups) or melted plastics can cause pitting of the surface of your cooktop. This is not covered under the warranty. You should clean the spill while it is still hot. Take special care when removing hot substances. Refer to the section below.
- When using a scraper, be sure it is new and the razor blade is still sharp. Do not use a dull or nicked blade.

### **Cleaning sugary spills and melted plastic**

1. Turn off all surface units. Remove hot pans.
2. Wearing an oven mitt, use a single-edge razor blade scraper to move the spill to a cool area of the cooktop. Remove the spill with paper towels.
3. Any remaining spillover should be left until the surface of the cooktop has cooled.
4. Don't use the surface units again until all of the residue has been completely removed.

## **Removing and reinstalling the oven door**

### **How to remove the door**

#### **CAUTION**

- The door is very heavy. Be careful when removing and lifting the door. Do not lift the door by the handle.
- Turn the power OFF before removing the door

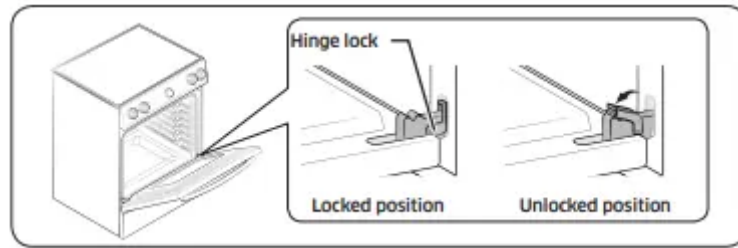

1. Open the door completely.
2. Pull the hinge locks down toward the door frame to the unlocked position.

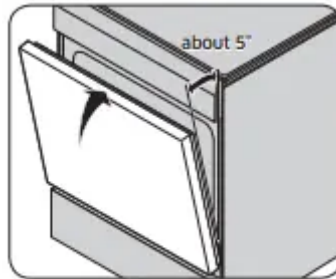

Fig. 1

3. Firmly grasp both sides of the door at the top.
4. Close the door to the door removal position, which is approximately 5 degrees from vertical (Fig.1)
5. Lift door up and out until the hinge arm is clear of the slot. (Fig.2)

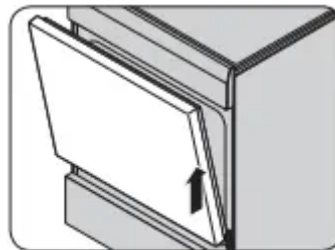
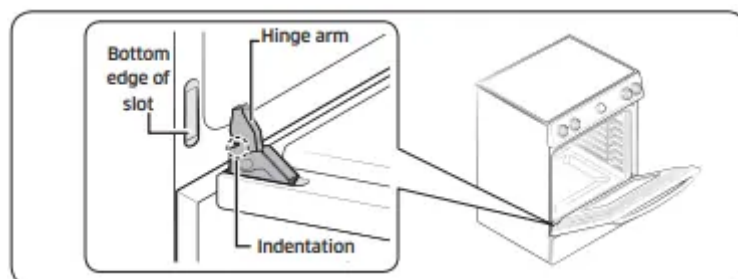
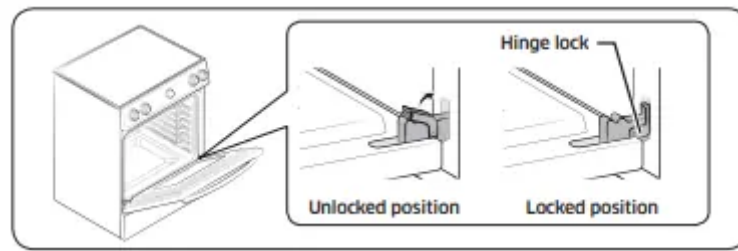

Fig. 2

**How to re-install the door:**



1. Firmly grasp both sides of the door at the top.
2. With the door at the same angle as the removal position, slide the indentation of the hinge arm into the bottom edge of the hinge slot. The notch in the hinge arm must be fully inserted into the bottom of the slot.



3. Open the door fully. If the door will not open fully, the indentation is not inserted correctly in the bottom edge of the slot.

4. Push the hinge locks up against the front frame of the oven cavity to the locked position.

5. Close the oven door.

## Removing and reinstalling the storage drawer

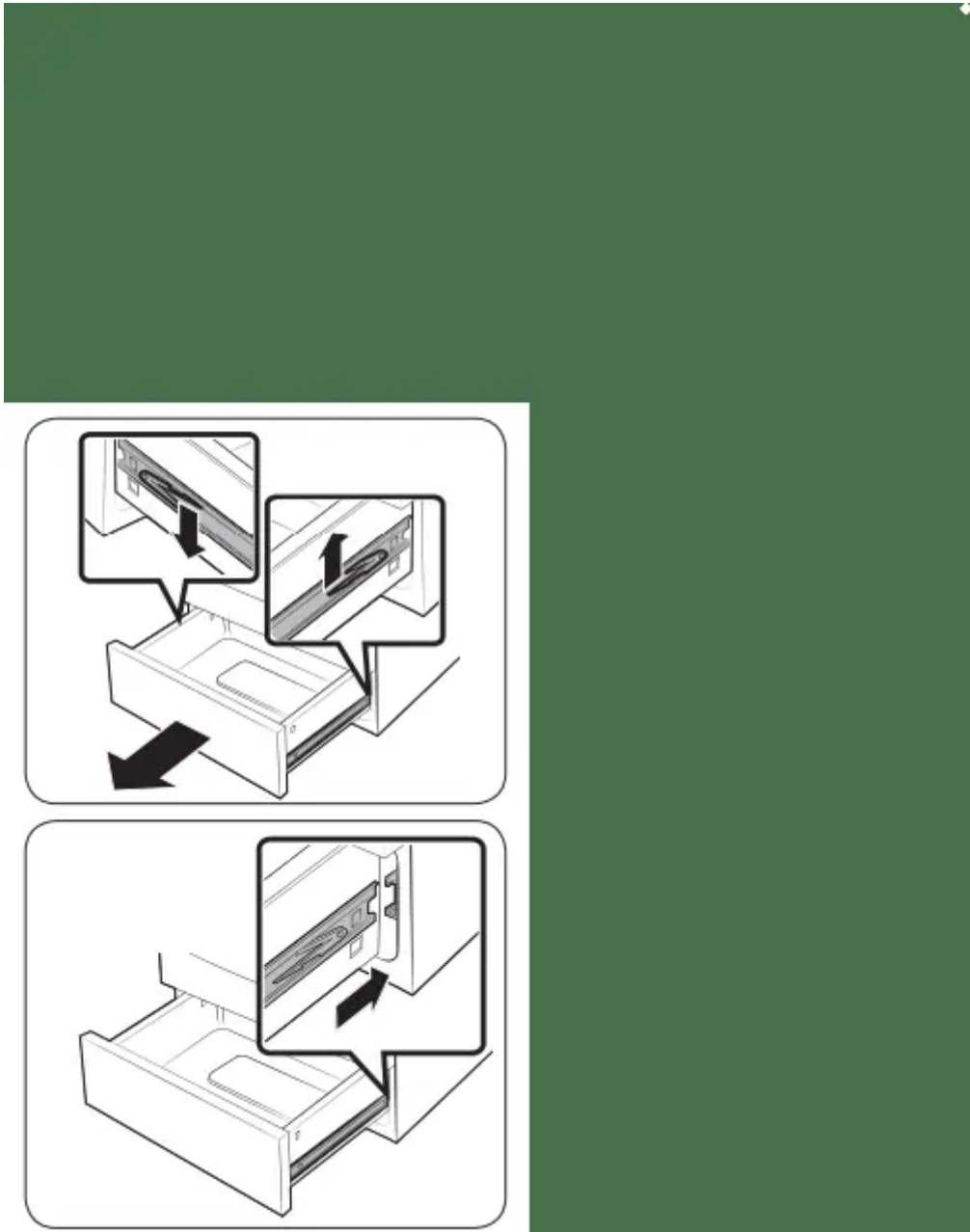

1. Slide open the drawer until it stops.
2. Locate the roller guide clips on either side. Using both hands, pull down the left clip while lifting the right clip, and then remove the drawer.
3. Clean the drawer in warm, soapy water using a cloth or soft brush. Then, rinse and dry it thoroughly.
4. Put the drawer in the roller guides on either side, and then snap the clips into place.

## Changing the oven light

The oven light is a standard 40-watt appliance bulb. It will come on when the oven door is open. When the oven door is closed, press the  pad to turn it on or off. It will not work during a self-cleaning cycle.

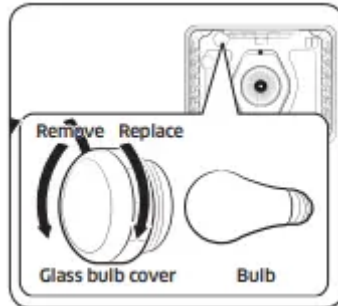

1. Make sure the oven and the bulb are cool.
2. Unplug the range or disconnect the power.
3. Turn the glass bulb cover in the back of the oven counterclockwise to remove.
4. Turn the bulb counterclockwise to remove it from its socket.
5. Insert a new 40 watt appliance bulb, and then turn it clockwise to tighten. Replace the bulb cover by turning clockwise.
6. Plug in the range or reconnect the power.

**CAUTION:** Before changing your oven light bulb, disconnect the electrical power to the range at the main fuse or circuit breaker panel. Make sure the oven and the bulb are cool.

## Troubleshooting

### Installation

#### The range is not level.

- The appliance has been installed improperly.
  - Place the oven rack in the center of the oven. Place a level on the oven rack. Adjust the leveling legs at the base of the range until the oven rack is level.
  - Insure the floor is level and strong and stable enough to adequately support the range.
- The floor is sagging or sloping.
  - Contact a carpenter to correct the situation.
- The kitchen cabinets are not properly aligned and make the range appear to be not level.
  - Insure the cabinets are square and provide sufficient room for installation.

**The appliance must be accessed for servicing and cannot be moved easily.**

- The kitchen cabinets are not square and too close to the appliance.
  - Contact a builder or installer to make the appliance accessible.
- Carpet is interfering with movement of the range.
  - Provide sufficient space so the range can be lifted over the carpet.

**CONTROL DISPLAY**

**The display goes blank.**

- A fuse in your home may be blown or the circuit breaker tripped.
  - Replace the fuse or reset the circuit breaker.

**The display flashes.**

- There was a power failure.
  - Reset the clock.

**COOKTOP**

**The surface units will not maintain a rolling boil or will not cook fast enough.**

- You may be using inappropriate cookware.
  - Use pans that are flat and match the diameter of the surface unit selected.
- In some areas, the power (voltage) may be low.
  - Cover the pan with a lid until the desired heat is obtained.

**The surface units will not turn on.**

- A fuse in your home may be blown or a circuit breaker may have tripped.
  - Replace the fuse or reset the circuit breaker.
- The cooktop controls are set improperly.
  - Check if the correct control is set for the surface unit you are using.

**Areas of discoloration on the cooktop.**

- Food spillover was not cleaned.
  - Refer to the section on the care and cleaning of the glass cooktop.
- The surface is hot and the model features a lightcolored cooktop.
  - This is normal. The surface may appear discolored when it is hot. This is temporary and will disappear as the glass cools.

**The surface unit frequently cycles on and off.**

- The element will cycle on and off to maintain the power setting.
  - This is normal operation, and not a system failure. Use the range as usual.

**The surface unit stops glowing when changed to a lower setting.**

- This is normal. The unit is still on and hot.

**Scratches or abrasions on the cooktop surface.**

- The cooktop is being cleaned improperly.
  - Scratches are not removable. Tiny scratches will become less visible in time as a result of cleaning. Use ceramic glass top cleaning cream. Do not use chemical or corrosive agents. These agents may damage the surface of the product.
- Cookware with rough bottoms was used on the cooktop or there were coarse particles (e.g., salt or sand) present between the cookware and the surface of the cooktop.
- Cookware has been slid across the cooktop surface.
  - To avoid scratches, follow the recommended cleaning procedures. Make sure cookware bottoms are clean before use, and use cookware with smooth bottoms

**Brown streaks or specks.**

- Boilovers have been cooked onto the surface.
  - Wait until the surface cools down. Then, use a single-edge razor-blade scraper at approximately a 45° angle against the glass surface to remove the soil.
  - See the section on the care and cleaning of the glass cooktop.

**Areas of discoloration with metallic sheen.**

- Mineral deposits from water and food have been left on the surface of the cooktop.
  - Remove using a ceramic-glass cooktop cleaning cream.
  - Use cookware with clean, dry bottoms. Clean the cooktop with a ceramic cleaning agent regularly every week.

**"Cracking" or "popping" sound.**

- This is the sound of the metal heating and cooling during both the cooking and self-cleaning functions.
  - This is normal operation, and not a system failure. Use the range as usual.

## **OVEN**

### **The oven will not turn on.**

- The range is not completely plugged into the electrical outlet.
  - Make sure the electrical plug is inserted into a live, properly grounded outlet.
- A fuse in your home may be blown or a circuit breaker may have tripped.
  - Replace the fuse or reset the circuit breaker.
- The oven controls have been set improperly.
  - See the chapter on operating the oven starting.
- The oven is too hot.
  - Allow the oven to cool.
- Incomplete service wiring.
  - Call for service.
- Power outage.
  - Check to see if the house lights will turn on. If necessary, call your local electric company for service.

### **The oven light will not turn on.**

- The light bulb is loose or defective.
  - Tighten or replace the bulb.
- The switch operating the light is broken.
  - Call for service.

### **The appliance will not turn on.**

- The appliance is not completely plugged into the electrical outlet or a fuse in your home may be blown or a circuit breaker may have tripped.
  - Make sure the power cord is plugged into a live, properly grounded outlet. Check the fuse and circuit breakers.
- Incomplete service wiring.
  - Call for service.
- Power outage.
  - Check to see if the house lights will turn on. If necessary, call your local electric company for service.

**The oven smokes excessively during broiling.**

- The oven controls have not been set properly.
  - Refer to the section on using the broiler starting.
- The meat has been placed too close to the element.
  - Reposition the rack to provide proper clearance between the meat and the element. Preheat the broil element for searing.
- The meat has not been properly prepared.
  - Remove the excess fat from the meat. Cut away fatty edges that may curl, leaving the lean intact.
- Grease has built up on oven surfaces.
  - Regular cleaning is necessary when broiling frequently

**Food does not bake or roast properly.**

- The oven controls have not been set correctly.
  - See the chapter on operating the oven starting.
- Incorrect cookware or cookware of improper size is being used.
- The oven rack has been positioned incorrectly or is not level.
  - See the section on using the oven racks on page 36.
- The oven sensor needs to be adjusted.
  - See the section on adjusting the thermostat.

**Food does not broil properly.**

- The serving size may not be appropriate.
  - Refer to the cooking guide for serving sizes, and then try again.
- The rack has not been properly positioned.
  - See the broiling recommendation guide.
- The cookware is not suited for broiling.
  - Use suitable cookware.
- In some areas, the power (voltage) may be low.
  - Preheat the broil element for 10 minutes.
  - See the broiling recommendation guide.

**The oven temperature is too hot or too cold.**

- The oven sensor needs to be adjusted.
  - See the section on adjusting the thermostat.

**The oven will not self-clean.**

- The oven temperature is too high to start a self-clean operation.
  - Allow the range to cool and then reset the controls.
- The oven controls have been set incorrectly.
  - See the section on selfcleaning.
- A self-cleaning cycle cannot be started if the oven lock feature has been activated or if a radiant surface element is on.
  - Deactivate the oven lock (see page 28). Make sure all surface elements are turned off.

**Excessive smoking during a self-cleaning cycle.**

- There is excessive soiling in the oven.
  - Press OFF. Open the windows to rid the room of smoke. Wait until the self-cleaning cycle is cancelled. Wipe up the excessive soil and then start the self-cleaning cycle again.

**The oven door will not open after a selfcleaning cycle.**

- The oven is too hot.
  - Allow the oven to cool.

**The oven is not clean after a self-cleaning cycle.**

- The oven controls were not set correctly.
  - See the section on selfcleaning.
- The oven was heavily soiled.
  - Wipe up heavy spillovers before starting the selfcleaning cycle. Heavily soiled ovens may need to be selfcleaned again or for a longer period of time.

**Steam is coming out of the vent.**

- When using the convection feature, it is normal to see steam coming out of the oven vent.
- As the number of racks or amount of food being cooked increases, the amount of visible steam will increase.
  - This is normal operation and not a system failure. Use the range as usual.

### **A burning or oily odor is coming from the vent.**

- This is normal in a new oven and will disappear in time.
  - To speed the process, set a self-cleaning cycle for a minimum of 3 hours.
  - See the section on selfcleaning.

### **Strong odor.**

- An odor coming from the insulation around the inside of the oven is normal for the first few times the oven is used.
  - Operate the oven empty on the bake setting at 400 °F for 1 hour.

### **Fan noise.**

- A convection fan may automatically turn on and off.
  - This is not a system failure but normal operation

### **Oven racks are difficult to slide.**

- The shiny, silver-colored racks were cleaned in a selfcleaning cycle.
  - Apply a small amount of vegetable oil to a paper towel, and then wipe the edges of the oven racks with the paper towel.

## **DRAWER**

### **The drawer does not slide smoothly or drags.**

- The drawer is out of alignment.
  - Fully extend the drawer and push it all the way in.
- The drawer is overloaded or the load is unbalanced.
  - Reduce weight. Redistribute drawer contents.

### **Excessive condensation in the drawer.**

- There is liquid present in the drawer.
  - Remove the liquid.
- Uncovered foods.
  - Cover food with a lid.

## **Information codes**

### **OVEN**

Possible cause:

- Code C-d0: There is a short in the control key.

- Code C-d1: The door lock is misaligned.
- Code C-F0: This code occurs if communication between the Main and Sub PBA is interrupted.
- Code C-F2: This code occurs if communication between the Main and Touch is interrupted.
- Code C-20: The oven sensor is open when the oven is operating. There is a short in the Oven sensor.
- Code C-21: This code occurs if the internal temperature rises abnormally high.

Solution:

- Press OFF, and then restart the oven. If the problem persists, disconnect all power to the range for at least 30 seconds and then reconnect the power. If this does not solve the problem, call for service.

### **Displayed Code C-22 and C-30:**

Possible cause:

- Code C-22:
  - The PCB sensor is open when the oven is operating.
  - There is a short in the PCB sensor.
- Code C-23: The temperature probe sensor is short when the oven is operating.
- Code C-30:
  - The main PCB sensor is open when the oven is operating.
  - There is a short in the PCB sensor.

Solution:

- Press OFF, and then restart the oven. If the problem persists, disconnect all power to the range for at least 30 seconds and then reconnect the power. If this does not solve the problem, call for service.

### **Displayed Code C-31**

Possible cause:

- This code occurs if the PCB temperature rises abnormally high.

Solution:

- Call for service.

### **Displayed -dC-**

Possible cause:

- This code appears if the divider is inserted or removed while the oven is operating.

Solution:

- Make sure the divider is inserted properly, and then restart the oven. If the problem persists, disconnect all power to the range for at least 30 seconds and then reconnect the power. If this does not solve the problem, call for service

### **Displayed Bad line**

Possible cause:

- This error message appears if the power cord is installed improperly.

Solution:

- If the power connection is plugged in improperly, that code appears on the display. Reconnect the power connection properly, and the message disappears

### **Displayed Code C-A2**

Possible cause:

- This code occurs if the sub PCB temperature rises abnormally high.

Solution:

- Press OFF. Check the oven vent and cooling vent. If the vent is closed, never block the vent by anything. After cooling the oven, restart the oven. If this does not solve the problem, call for service

#### **Warning**

This content is compiled from multiple sources and is provided for reference purposes only. It may not be complete or fully applicable to all situations. If you are unable to resolve your issue, please contact the product manufacturer or an authorized service provider for official support.