

Operating Instructions

About the dishwasher control panel.

For use with GLC4400 Series

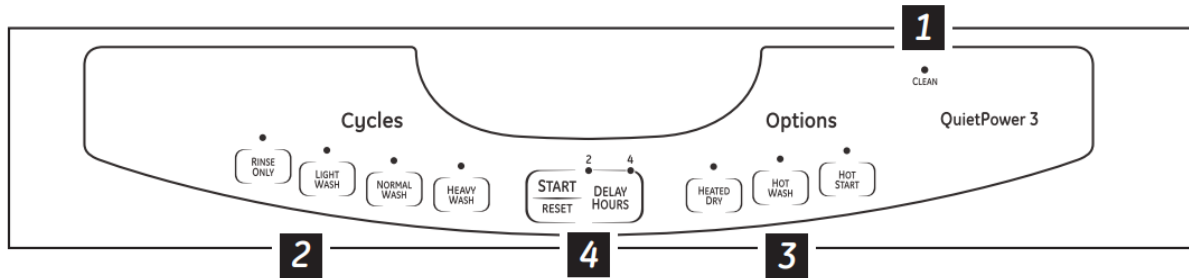

1. Status Indicator Lights

The Status indicator lights tell you what's happening while the dishwasher is in operation. The lights will come **ON** indicating the sequence of operation the dishwasher is in.

CLEAN Displayed when a wash cycle is complete. The light stays **ON** as a reminder that the dishes are clean until the door is opened or until another cycle is selected.

2. Cycles

The light above the selected pad will be ON to indicate which cycle has been selected.

HEAVY WASH

8.5 gal., 89 min.

This cycle is meant for heavily soiled dishes or cookware with dried-on or baked-on soils. Everyday dishes are safe to be used in this cycle.

NORMAL WASH

5.9 gal., 56 min.

This cycle is for medium/heavily soiled dishes and glassware.

LIGHT WASH

6.1 gal., 36 min.

This cycle is for everyday dishes and glassware.

CHINA CRYSTAL	6.1 gal., 39 min. This cycle is for lightly soiled china and crystal.
RINSE ONLY	1.2 gal., 6 min. For rinsing partial loads that will be washed later. Do not use detergent with this cycle.

3. Options

The light above the selected pad will be **ON** to indicate which **OPTION** has been selected.

<p>HOT START (on some models)</p>	<p>For use with heavily soiled and/or dried-on, baked-on soils. This option MUST be selected PRIOR to starting the cycle. <i>This option will improve both wash and dry performance. This option adds 20 minutes to the cycle time. NOTE: Cannot be selected with RINSE ONLY cycle.</i></p>
<p>HEATED DRY Light OFF</p>	<p>Shuts off the drying heat option. Dishes air dry naturally and energy is saved. For faster air dry you can prop the door open after the CLEAN light illuminates.</p>
<p>HEATED DRY Light ON</p>	<p>Turns the heater on for faster drying. This will extend the total run time by 38 minutes. NOTE: Cannot be selected with RINSE ONLY cycle.</p>
<p>LOCK  (on some models)</p>	<p>You can lock the controls to prevent any selections from being made. Or you can lock the controls after you have started a cycle. Children cannot accidentally start dishwasher by touching pads with this option selected.</p>
<p>HOT WASH</p>	<p>When selected, the cycle will run longer with the heating element on to improve both wash and dry performance. NOTE: Cannot be selected with RINSE ONLY cycle.</p>
<p>DELAY HOURS</p>	<p>You can delay the start of a wash cycle for 2, 4 or 8 hours (delay time options may vary by model). Touch the DELAY HOURS pad to choose the number of hours you want to delay the start of the cycle; then touch START/RESET one time. The dishwasher will count down and start automatically at the correct time. Touching START/RESET a second time will cancel the DELAY HOURS selection.</p>
<p>RESET</p>	<p>To change a cycle after washing starts, touch the START/RESET pad to cancel the cycle. The Cycle light will flash while the water is pumped out if needed. This takes approximately 2 minutes. When the light stops flashing, the dishwasher can be reprogrammed and restarted.</p>

4. Start

Close and latch the dishwasher door and select the cycle and desired enhancements. Touch the **START/RESET** pad once to begin the cycle. Water begins to fill the dishwasher, and approximately 60 seconds later the wash action begins. Touching the **START/RESET** pad a second time will cancel the cycle and cause the water to drain out. This will take approximately 2 minutes.

NOTE: When the dishwasher door is fully closed, the control panel lights will display the last settings you selected.

If you don't want to change any of the settings, simply touch the **START/RESET** pad once to begin the cycle.



If the door is closed, the indicator lights will turn off if the **START/RESET** pad is not pressed within two minutes. To activate the display, open and close the door or touch any pad.

Also, if a power failure occurs or the unit is first plugged into the wall, **NORMAL** and **HEATED DRY** will automatically be programmed.

For use with GLC4400 Series

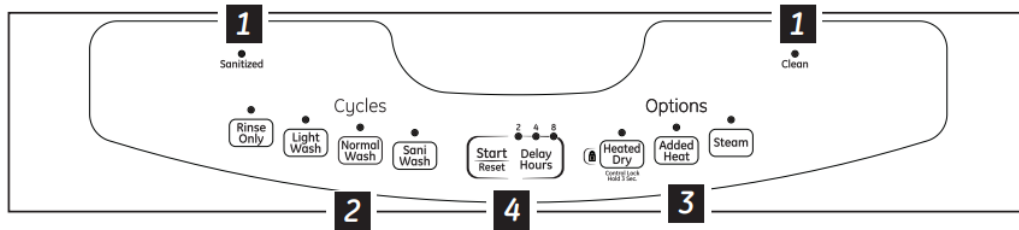

1. Status Indicator Lights

The Status indicator lights tell you what's happening while the dishwasher is in operation. The lights will come ON indicating the sequence of operation the dishwasher is in.

SANITIZED	Displayed when cycle has met sanitization conditions. Light remains <i>ON</i> until door is opened.
CLEAN	Displayed when a wash cycle is complete. The light stays <i>ON</i> as a reminder that the dishes are clean until the door is opened or until another cycle is selected.
<p>2. Cycles</p> <p>The light above the selected pad will be <i>ON</i> to indicate which cycle has been selected.</p>	
SANI WASH	<p>7.3 gal., 97 min.</p> <p>This cycle raises the water temperature in the final rinse to sanitize your dishware.</p> <p>The cycle length will vary depending on the temperature of your inlet water.</p> <p>NOTE: The <i>SANI-WASH</i> cycle is monitored for sanitization requirements. If the cycle is interrupted during or after the main wash portion or if the incoming water temperature is so low that adequate water heating cannot be achieved, the sanitizing conditions may not be met. In these cases, the sanitized light will not illuminate at the end of the cycle.</p> <p>NOTE: NSF certified residential dishwashers are not intended for licensed food establishments.</p>
NORMAL WASH	<p>5.9 gal., 56 min.</p> <p>This cycle is for medium/heavily soiled dishes and glassware.</p>
LIGHT WASH	<p>6.1 gal., 36 min.</p> <p>This cycle is for everyday dishes and glassware.</p>
RINSE ONLY	<p>1.2 gal., 6 min.</p> <p>For rinsing partial loads that will be washed later. Do not use detergent with this cycle.</p>

NOTE: Only the *SANI-WASH* cycle has been designed to meet the requirements of Section 6, NSF 184 for soil removal and sanitization efficacy.

3. Options



The light above the selected pad will be ON to indicate which OPTION has been selected.

<p>STEAM</p>	<p>For use with heavily soiled and/or dried-on, baked-on soils. This option <i>MUST</i> be selected <i>PRIOR</i> to starting the cycle. <i>This option will improve both wash and dry performance. This option adds 20 minutes to the cycle time.</i></p> <p><i>NOTE: Cannot be selected with RINSE ONLY cycle.</i></p>
<p>HEATED DRY <i>Light OFF</i></p>	<p>Shuts off the drying heat option. Dishes air dry naturally and energy is saved. For faster air dry you can prop the door open after the <i>CLEAN</i> light illuminates.</p>
<p>HEATED DRY <i>Light ON</i></p>	<p>Turns the heater on for faster drying. This will extend the total run time by 38 minutes.</p> <p><i>NOTE: Cannot be selected with RINSE ONLY cycle.</i></p>
<p>LOCK </p>	<p><i>You can lock the controls to prevent any selections from being made. Or you can lock the controls after you have started a cycle.</i></p> <p><i>Children cannot accidentally start dishwasher by touching pads with this option selected.</i></p> <p>To LOCK the dishwasher control, touch and hold the <i>HEATED DRY</i> pad for 3 seconds. The light left of the <i>HEATED DRY</i> pad will turn on. To UNLOCK the dishwasher control, touch and hold the <i>HEATED DRY</i> pad for 3 seconds. The <i>LOCK</i> light will turn off.</p>
<p>ADDED HEAT</p>	<p>When selected, the cycle will run longer with the heating element on to improve both wash and dry performance. <i>NOTE: Cannot be selected with RINSE ONLY cycle.</i></p>
<p>DELAY HOURS</p>	<p>You can delay the start of a wash cycle for 2, 4 or 8 hours (delay time options may vary by model). Touch the <i>DELAY HOURS</i> pad to choose the number of hours you want to delay the start of the cycle; then touch <i>START/RESET</i> one time. The dishwasher will count down and start automatically at the correct time.</p> <p>Touching START/RESET a second time will cancel the DELAY HOURS selection.</p>

4. Start

Close and latch the dishwasher door and select the cycle and desired enhancements. Touch the *START/RESET* pad once to begin the cycle. Water begins to fill the dishwasher, and approximately



60 seconds later the wash action begins. Touching the *START/RESET* pad a second time will cancel the cycle and cause the water to drain out. This will take approximately 2 minutes.

NOTE: The dishwasher remembers your last cycle so you don't have to reprogram each time. When the dishwasher door is fully closed, the control panel lights will display the last settings you selected.

If you don't want to change any of the settings, simply touch the *START/RESET* pad once to begin the cycle.

If the door is closed, the indicator lights will turn off if the *START/RESET* pad is not pressed within two minutes. To activate the display, open and close the door or touch any pad.

Also, if a power failure occurs, *NORMAL* and *HEATED dry* will automatically be programmed.

About the unicouple.

Before Operating the Dishwasher the First Time



Attach the faucet adapter. The special faucet adapter supplied with your dishwasher must be assembled to the sink faucet before you can use your dishwasher.

The faucet adapter is designed to fit standard spouts having internal or external threads. You will find the adapter and two washers in the faucet adapter packet in your dishwasher.

To install faucet adapter, first remove the old aerator or trim ring on your faucet spout.

If faucet has external threads: Insert the thinner of the two washers into the faucet adapter and attach it to the faucet spout.

Tighten with pliers.

If faucet has internal threads: Insert both of the washers into the faucet adapter and attach it to the faucet spout.

Tighten with pliers.

If the faucet adapter threads do not match your faucet spout, your local hardware or plumbing supply store normally has additional fittings to adapt your faucet spout to the special faucet adapter.

NOTE: A sink spray attachment hose can burst if it is installed on the same sink with your dishwasher. We suggest that you disconnect the sink spray attachment if your sink has one and plug the hole.

How to Connect the unicouple

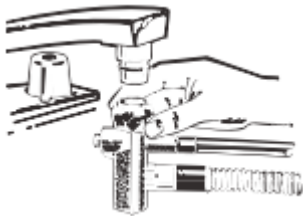

1. Run the hot water faucet to purge cold water from the hot water line. The hot water must be between 120°F and 150°F for best wash performance.
2. Pull Unicouple and its hoses completely out from storage compartment located at rear of dishwasher.
3. Attach the Unicouple connector to the faucet adapter by depressing the collar at the top of the connector. When Unicouple is all the way up onto the adapter, release the collar. It will then snap into position to lock the Unicouple in place.

The Unicouple's small hose carries water from the faucet to the dishwasher. Its large hose carries drain water to the sink. Be sure Unicouple is pointing toward the sink bowl drain opening and the sink drain is open for water that will drain from your dishwasher.

If your dishwasher drains into a disposer, operate the disposer until it is completely empty before starting the dishwasher.

4. Turn hot water fully on before starting the dishwasher.
5. Plug the dishwasher power cord into the outlet.

How to Disconnect the Dishwasher

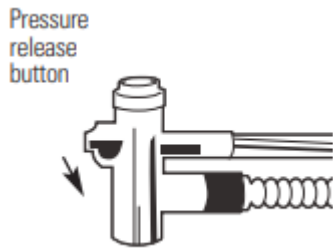

1. Unplug the dishwasher.
2. Push the cord back into its storage location.
3. Turn off the hot water.
4. Release the water pressure by depressing the pressure release button.
5. Release the Unicouple from the faucet by depressing the collar at the top of the Unicouple connector.
6. Drain excess water from the unicouple hoses (see below). Push the hoses back into their storage location.

How to Drain Excess Water From unicouple Hoses

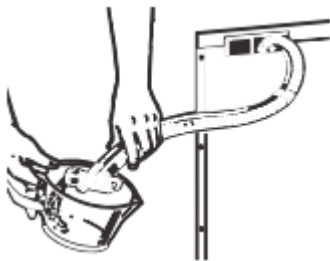

If the sink is 34" or higher from the floor, the excess water in Unicouple hoses cannot be drained directly into the sink. It will be necessary to drain excess water from hoses into a bowl or suitable container that is held outside and lower than the sink

Using the dishwasher.

Check the Water Temperature

The entering water should be at least 120°F and not more than 150°F, for effective cleaning and to prevent dish damage. Check the water temperature with a candy or meat thermometer. Turn on the hot water faucet nearest the dishwasher, place the thermometer in a glass and let the water run continuously into the glass until the temperature stops rising.

Use Cascade Crystal Clear ® Rinse Agent

Cascade Crystal Clear ® rinse agent removes spots and prevent new film buildup on your dishes, glasses, flatware, cookware and plastic.

Filling the Dispenser

The rinse agent dispenser holds 100 ml (3.5 fl. oz.) of rinse agent. Under normal conditions, this will last approximately one month. Try to keep it full, but do not overfill.

1. Make sure the dishwasher door is fully open.
2. Turn the dispenser cap to the left and lift it out.
3. Add rinse agent until the indicator window looks full.
4. Clean up any spilled rinse agent with a damp cloth.
5. Replace the dispenser cap.

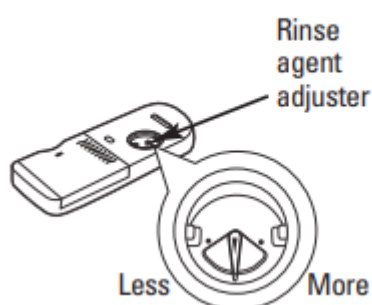
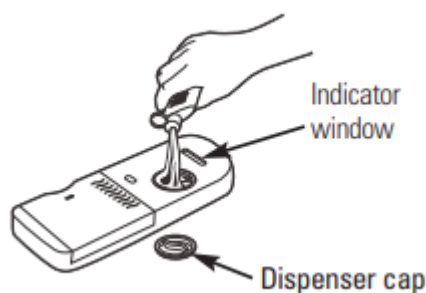

Rinse Aid Setting

The amount of rinse agent released into the final wash can be adjusted. The factory setting is at the midpoint. If there are rings of calcium (hard water) spots on dishes, try a higher setting. If you see foam in the dishwasher, move the indicator to a lower setting.

To adjust the setting

Remove the dispenser cap; then turn the adjuster counter clockwise to increase the amount of rinse agent, clockwise to reduce the amount of rinse agent.

Dish Preparation Prior to Loading

- No pre-rinsing of normal food soil is required.
- Scrape off hard soils, including bones, toothpicks, skins and seeds.
- Remove large quantities of any remaining food.
- Remove leafy vegetables, meat trimmings and excessive amounts of grease or oil.
- Remove acidic food soils that can discolor stainless steel.

Proper Use of Detergent

Use only detergent specifically made for use in dishwashers. *Cascade®* Automatic Dishwashing Detergents have been approved for use in all GE dishwashers. Keep your detergent fresh and dry. Don't put powder detergent into the dispenser until you're ready to wash dishes.

The amount of detergent to use depends on whether your water is *hard* or *soft*. With hard water, you need extra detergent. With soft water, you need less detergent.

Protect your dishes and dishwasher by contacting your water department and asking how hard your water is. Twelve or more grains is extremely hard water. A water softener is recommended. Without it, lime can build up in the water valve, which could stick while open and cause flooding. Too much detergent with soft water can cause a permanent cloudiness of glassware, called *etching*.

Use the information in the table below as a guideline to determine the amount of automatic dishwasher detergent to place in the dispenser.

<i>Number of Grains</i>	<i>Detergent Cups to Fill</i>
Less than 4	Fill cup to first line
4 to 8	Fill cup to second line
8 to 12	Fill main wash cup
Greater than 12	Fill both Main Wash and Pre Wash cup

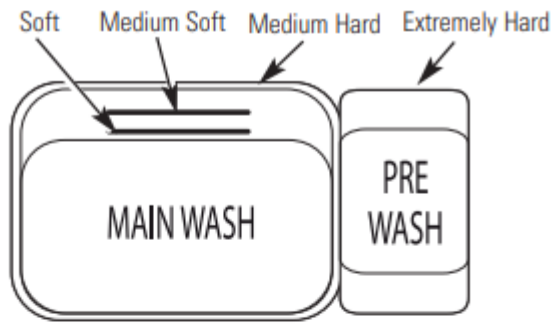

For heavily-soiled loads, use the Pots and Pans or Heavy Wash cycle and add a little extra detergent.

DO NOT USE HAND DISH DETERGENT

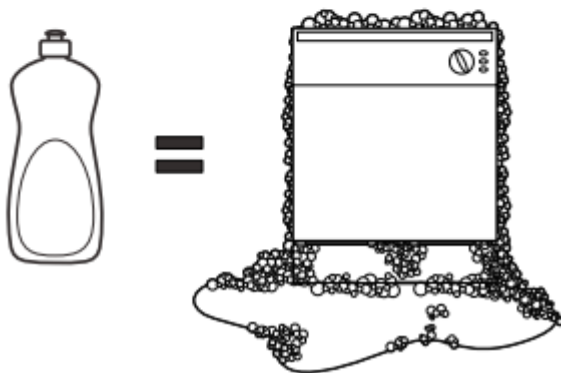

NOTE: Using a detergent that is not specifically designed for dishwashers will cause the dishwasher to fill with suds. During operation, these suds will spill out of the dishwasher vents, covering the kitchen floor and making the floor wet.

Because so many detergent containers look alike, store the dishwasher detergent in a separate space from all other cleaners. Show anyone who may use the dishwasher the correct detergent and where it is stored.

While there will be no lasting damage to the dishwasher, your dishes will not get clean using a dishwashing detergent that is not formulated to work with dishwashers.

Forget to Add a Dish?

A forgotten dish can be added any time before the main wash.

1. Squeeze the door latch to release the door.
2. Do not open the door until the water spray action stops. Steam may rise out of the dishwasher.
3. Add forgotten dishes.
4. Close the door.



Loading the dishwasher racks.

For best dishwashing results, follow these loading guidelines. Features and appearance of racks and silverware baskets may vary from your model

Upper Rack



Although the upper rack is for glasses, cups and saucers, pots and pans can be placed in this rack for effective cleaning. Cups and glasses fit best along the sides. This is also a secure place for dishwasher-safe plastics.

The utility shelf (on some models) may be placed in the up or down position to add flexibility. A wine glass holder (on some models) secures wine glasses for best washability. Because wine glasses come in various sizes, after loading, slowly push in the rack to make sure they will clear the top of the dishwasher.

The upper rack is good for all kinds of odd-shaped utensils. Saucepans, mixing bowls and other items should be placed face down. Fold-down tines (on some models) provide flexibility for extra-large and hard-to-fit items.

Secure larger dishwasher-safe plastics over 2 tines when possible.

Make sure small plastic items are secure so they can't fall onto the heater.

Be sure that items do not protrude through the bottom of the rack and block rotation of the middle spray arm. This could result in poor wash performance for items in the upper rack.

Check to make sure that no items will block rotation of the wash arms

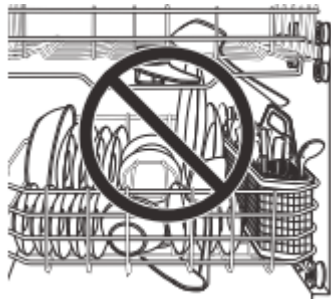

Lower Rack

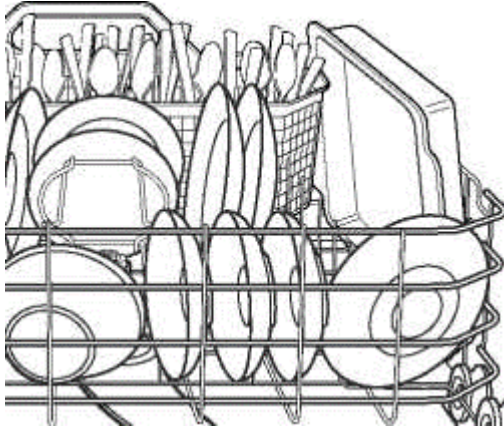

The lower rack is best used for plates, saucers and cookware. Large items such as broiler pans and baking racks should go along the left-hand side. Load platters, pots and bowls along the sides, in corners or in the back. The soiled side of items should face the center of the rack. If necessary, oversized glasses and mugs can be placed in the lower rack to maximize loading flexibility.

Also, be careful not to let a portion of an item such as a pot or dish handle extend through the bottom rack. This could block the wash arm and cause poor washing results.

Fold-down tines (on some models) provide flexibility for extra-large and hard-to-fit items. The tines may be left in the up position or folded down to customize the lower rack.

Do not let any item extend through the bottom of the silverware basket. Items that extend through the rack could prevent the spray arm from turning and cause poor wash performance.



Silverware Basket

Single basket (on some models)

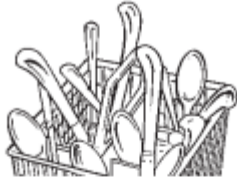

One-piece basket (on some models)



Three-piece basket (on some models)



To remove end baskets, grasp the basket at opposite corners and slide apart.

To load flatware, simply push the adjustable handle to either side (on some models). Put flatware in the removable basket with fork and knife handles up to protect your hands. Place spoons in the basket with handles down. Mix knives, forks and spoons so they don't nest together. Distribute evenly. Small plastic items, such as measuring spoons and lids from small containers, should go in the bottom of the silverware basket with the silverware on top.

The one-piece silverware basket (on some models) can be placed in the front, right side or back of the lower rack.

A variety of options is available regarding the three-piece silverware basket (on some models) in your dishwasher. The complete basket is designed to fit on the right side of the lower rack. Additionally, each end of the basket is removable to add loading flexibility to accommodate flatware and lower rack capacity needs.

The lids of both end and middle baskets (on some models) can be closed to contain small items. Long items can be placed on the utility shelf in the upper rack.

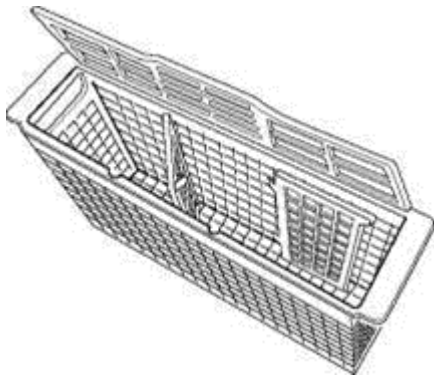

The accessory basket (on some models) can hold small items such as: baby bottle nipples, plastic lids, corn cob holders, etc.

Loading place settings...

Follow these guidelines for loading 10 place settings. Features and appearance of racks and silverware baskets may vary from your model.

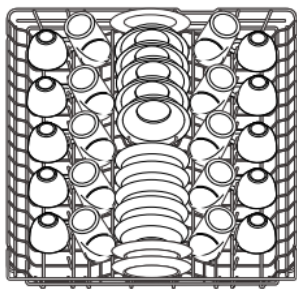

Upper Rack—10 place settings

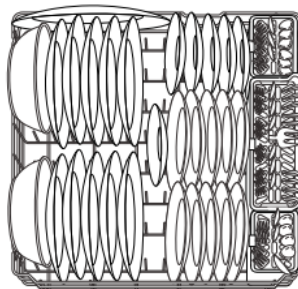

Lower Rack—10 place settings

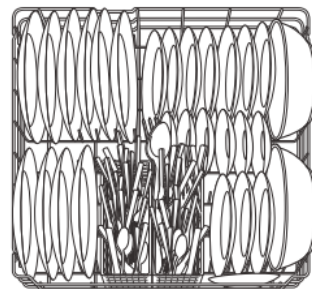

Lower Rack—10 place settings

Follow these guidelines for loading 12 place settings. Features and appearance of racks and silverware baskets may vary from your model.

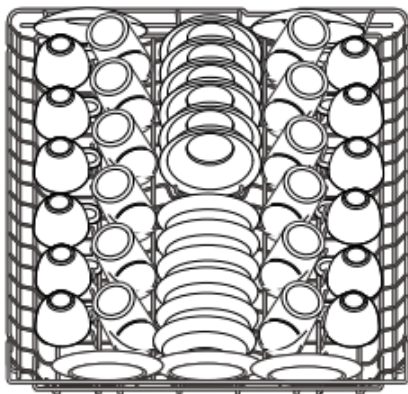

Upper Rack—12 place settings

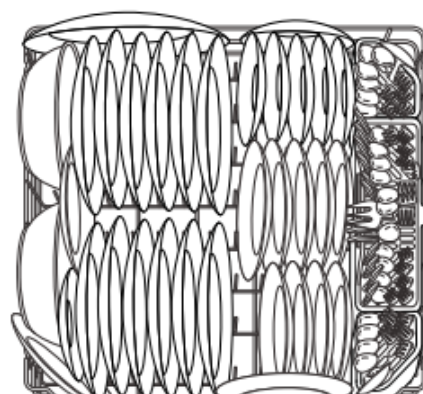

Lower Rack—12 place settings

Caring for the dishwasher.

Cleaning the Door Panel

Before cleaning the front panel, make sure you know what type of panel you have. Refer to the last two letters of your model number. You can locate your model number on the left-hand tub wall just inside the door. If your model number ends with BB, WW, CC, SA, BG or GS, then you have a Painted Door panel. If your model number ends with SS, then you have a Stainless Steel Door panel. If your model number ends with CS, then you have a CleanSteel Door panel.

Follow the instructions below for cleaning the door panel for your specific model.

Painted Door Panel (model numbers ending in BB-black, WW-white, CC-bisque, SA-silver metallic, BG-graphite metallic or GS-silver)

Use a clean, soft, lightly dampened cloth, then dry thoroughly. You may also use a good appliance wax or polish.

Stainless Steel Door Panel (model numbers ending in SS)

The stainless steel panels can be cleaned with *Stainless Steel Magic* or a similar product using a clean, soft cloth. Do not use appliance wax, polish, bleach or products containing chlorine on Stainless Steel doors.

You can order *Stainless Steel Magic #WX10X15* through GE Parts by calling 800.626.2002. In Canada, please call 1.800.661.1616.

CleanSteel Door Panel (model numbers ending in CS)

Use a clean, soft, lightly dampened cloth, then dry thoroughly. Do not use appliance wax, polish or any chemical agent on CleanSteel doors.

Do not wipe the dishwasher with a soiled dish cloth or wet towel. These may leave a residue. Do not use scouring pads or powdered cleaners because these products can scratch the finish.

Cleaning the Control Panel

To clean the control panel, use a lightly dampened cloth. Then dry thoroughly.

Protect Against Freezing

If your dishwasher is left in an unheated place during the winter, ask a service technician to:

1. Unplug the dishwasher from the wall outlet.
2. Remove the Unicouple from the faucet. Disconnect the hose from the water valve.
3. Drain water from the water inlet line and water valve. (Use a pan to catch the water.)
4. Reconnect the water inlet line to the water valve.

Troubleshooting Tips

before you call for service...



Error Messages

START/RESET status indicator light flashing

Dishwasher BEEPS once every 30 seconds

Dishes and flatware not clean

Spots and filming on glasses and flatware

Error Messages

Cloudiness on glassware

Suds in the tub



<i>Problem</i>	<i>Possible Causes</i>	<i>What To Do</i>
<i>Detergent left in dispenser cups</i>	Dishes are blocking the detergent cup	<ul style="list-style-type: none"> • Reposition the dishes, so the water from the lower spray arm can flush the detergent cup. See the <i>Loading the dishwasher</i> section.
<i>Black or gray marks on dishes</i>	Aluminum utensils have rubbed against dishes	<ul style="list-style-type: none"> • Remove marks with a mild, abrasive cleaner.
<i>Dishes don't dry</i>	Low inlet water temperature	<ul style="list-style-type: none"> • Make sure inlet water temperature is at least 120°F (50°C). • Select <i>HEATED DRY</i>. • Use <i>HOT START HOT WASH</i> or <i>ADDED HEAT</i> option. • Select a higher cycle, such as <i>HEAVY WASH</i>.
	Rinse agent dispenser is empty	<ul style="list-style-type: none"> • Check the rinse agent dispenser and fill as required.
<i>Control panel responded to inputs but dishwasher never filled with water</i>	Door latch may not be properly seated	<ul style="list-style-type: none"> • Make sure the door is firmly closed.
	Faucet may be turned off	<ul style="list-style-type: none"> • Make sure hot water faucet is turned on.
	Flood float may be stuck	<ul style="list-style-type: none"> • Remove the lower rack and tap lightly on the flood float (dome located at the left front corner of the tub bottom).
<i>Stained tub interior</i>	Some tomato-based foods can cause reddish stains	<ul style="list-style-type: none"> • Use of the <i>RINSE ONLY</i> cycle after adding the dishes to a load can decrease the level of staining.
	Tea or coffee stains	<ul style="list-style-type: none"> • Remove the stain by hand, using a solution of water and bleach.
	An overall yellow or brown film can be caused by iron deposits in water	<ul style="list-style-type: none"> • A special filter in the water supply line is the only way to correct this problem. Contact a water softener company for more information.



<i>Problem</i>	<i>Possible Causes</i>	<i>What To Do</i>
	<p>White film on inside surface water minerals</p>	<ul style="list-style-type: none"> • GE recommends Cascade Crystal Clear® to help prevent hard water mineral deposits from forming. <p>Run dishwasher with citric acid to remove mineral deposits. Citric acid (Part number: WD35X151) can be ordered from GE Parts. See back cover for ordering information.</p>



<i>Dishwasher won't run</i>	Fuse is blown or circuit breaker is tripped	<ul style="list-style-type: none"> • Replace fuse or reset circuit breaker. Remove any appliances from the circuit.
	Power is turned off	<ul style="list-style-type: none"> • In some installations, the power to the dishwasher is provided through a wall switch, often located next to the disposer switch. Make sure it is on.
	Control panel is locked	<ul style="list-style-type: none"> • Unlock control panel. See page 6.
	Reboot your control	<ul style="list-style-type: none"> • Unplug the dishwasher for 30 seconds; then plug
<i>Control panel lights go off when you're setting controls</i>	Time too long between touching of selected pads	<ul style="list-style-type: none"> • Each pad must be touched within 30 seconds of the last touch. To relight, touch any pad again, or unlock and reselect.
<i>Water standing in the bottom of the tub</i>	This is normal	<ul style="list-style-type: none"> • A small amount of clean water around the outlet on the bottom at the back of the tub keeps the water seal lubricated.
<i>Steam</i>	This is normal	<ul style="list-style-type: none"> • Warm, moist air comes through the vent by the door during drying and when water is being pumped out. This is necessary for drying.
<i>Noise</i>	Normal operating sounds	<ul style="list-style-type: none"> • Detergent cup opening. • Water entering dishwasher. • The motor stops and starts at various times during cycle. • Drain pump sounds during the pump out.
	Rattling dishes when the spray arm rotates	<ul style="list-style-type: none"> • Make sure dishes are properly loaded. See the <i>Load the dishwasher racks</i> section.

Warning



This content is compiled from multiple sources and is provided for reference purposes only. It may not be complete or fully applicable to all situations. If you are unable to resolve your issue, please contact the product manufacturer or an authorized service provider for official support.

Document generated by [ManualsFile](#)

