

## Getting Started

### Setting up

#### Connections

1. Connect the AC adaptor to the unit by pressing the plug firmly.
2. Connect the AC adaptor to the power outlet.
3. Connect the telephone line cord to the unit, then to the single-line telephone jack (RJ11C) until you hear a click.
4. A DSL/ADSL filter (not supplied) is required if you have a DSL/ADSL service

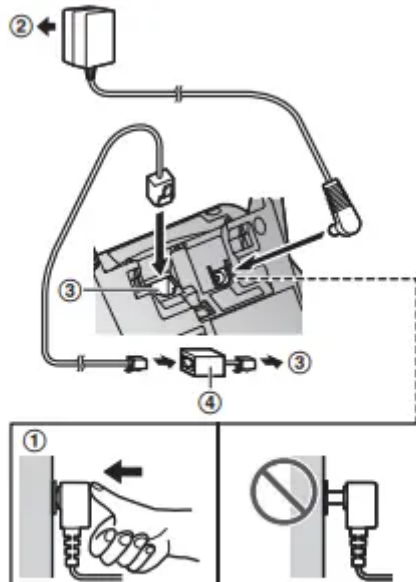

#### Battery installation

- USE ONLY rechargeable Ni-MH batteries AAA (R03) size ( A ).
- Do NOT use alkaline/manganese/Ni-Cd batteries.
- Confirm correct polarities ( + , - )

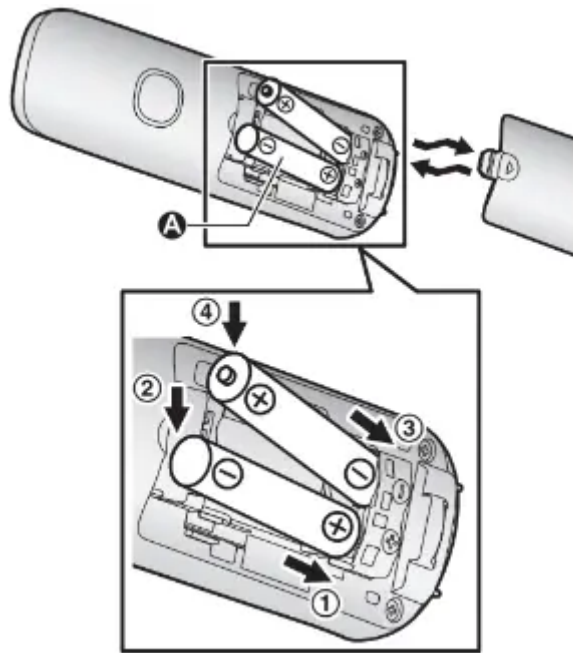

### Removing the battery

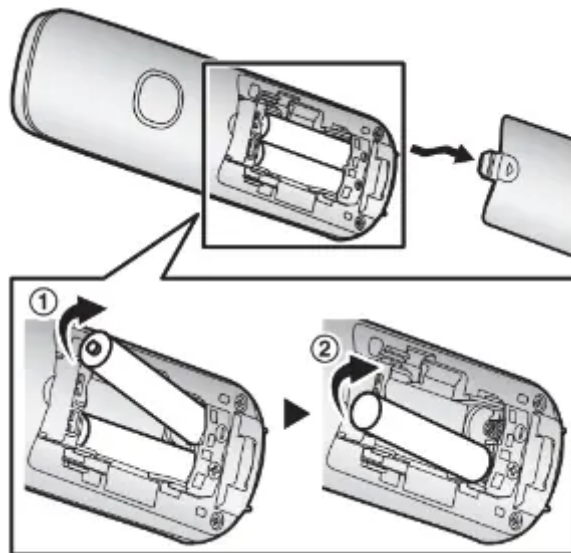





### Battery charging

- Charge for about 7 hours

### Note for battery charging

- Clean the charge contacts with a soft and dry cloth once a month. Before cleaning the unit, disconnect from power outlets and any telephone line cords.

### Battery level

Icon	Battery level
	High
	Medium
	Low
	Needs charging.
	Empty

### Panasonic Ni-MH battery performance (supplied batteries)

Operation	Operating time
In continuous use	10 hours max.* <sup>1</sup>
Not in use (standby)	5 days max.* <sup>1</sup>

Note: Actual battery performance depends on usage and ambient environment.

### Intelligent eco mode

This feature automatically reduces handset power consumption whenever possible. When it is activate, **ECO** is displayed.

## Controls

### Handset

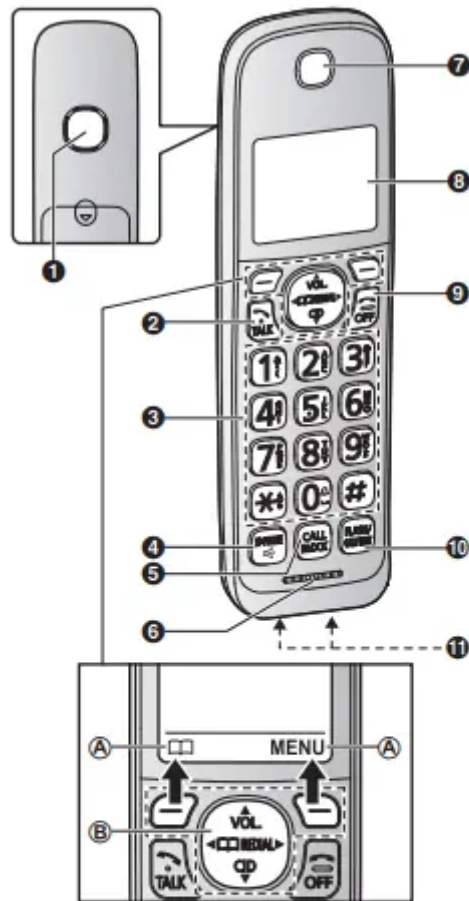

- ❶ Speaker
- ❷ **[↶]** (TALK)
- ❸ Dial keypad
  - ☒: Temporary tone dialing
  - ☒: (🔕) Ringer off
- ❹ **[📞]** (SP-PHONE: Speakerphone)
- ❺ **[CALL BLOCK]**
- ❻ Microphone
- ❼ Receiver

- 
- ❽ Display
  - ❾ **[OFF]** (↶)
  - ❿ **[FLASH][CALL WAIT]**
  - ⓫ Charge contacts
  - Ⓐ Soft keys
  - Ⓑ Navigator key
    - **[▲]**, **[▼]**, **[←]**, or **[→]**: Scroll through various lists and items.
    - VOL. (Volume: **[▲]** or **[▼]**): Adjust the receiver or speaker volume while talking.
    - **[←] ☐**: View the phonebook entry.
    - **[→] REDIAL**: View the redial list.
    - **[▼] CID** (Caller ID): View the caller list.

Base unit

■ KX-TGD510 series



- ❶ Charge contacts
- ❷ [LOCATOR](📶)

■ KX-TGD530 series



- ❶ Charge contacts
- ❷ Speaker
- ❸ [LOCATOR]
- ❹ Message counter
- ❺ [ + ]/[ - ] (VOL.: Volume up/down)
- ❻ [ERASE]
- ❼ [▶▶] (Skip)
- ❽ [▶■] (PLAY/STOP)
- Message indicator (▶)
- ❾ [ANSWER ON/OFF]
- ❿ [◀◀] (Repeat)

## Display icons

## Handset display items

Item	Meaning
	Within base unit range
	Out of base unit range
	The line is in use. <ul style="list-style-type: none"> <li>• When flashing: The call is on hold.</li> <li>• When flashing rapidly: An incoming call is now being received.</li> </ul>
<b>ECO</b>	Eco mode is on. (page 10)
	Speakerphone is on. (Page 13)
	Ringer volume is off. (page 13, 21)
	Silent mode is on. (page 25)
<b>PRIV.</b>	Call sharing mode is off. (page 23)
	Alarm is on. (page 24)
<b>1</b>	Handset number
	Battery level
	Blocked call (page 15)
<b>BOOST</b>	Clarity booster is on automatically.
<b>In use</b>	Answering system is being used by another unit. (KX-TGD530 series)

Item	Meaning
<b>Line in use</b>	Someone is using the line.

#### Base unit display item (KX-TGD530 series)

Item	Meaning
	"Greeting only" is selected. Caller messages are not recorded. (page 31)

## Language settings

### Display language

- 1 **[MENU]#1110**
- 2 **[↑/↓]**: Select the desired setting. → **[SAVE] → [OFF]**

### Voice announcement language (KX-TGD530 series)

You can select the language used for the following features.

- Answering system guidance
- Talking Caller ID

- 1 [MENU]#112
- 2 [↕]: Select the desired setting. →  
[SAVE] → [OFF]

## Date and time

- 1 [MENU]#101
- 2 Enter the current month, date, and year by selecting 2 digits for each.  
**Example:** July 12, 2017  
07 12 17
- 3 [OK]
- 4 Enter the current hour and minute (12-hour clock format) by selecting 2 digits for each.  
**Example:** 9:30  
09 30
- 5 [⊗]: Select "AM" or "PM".
- 6 [SAVE] → [OFF]

## Recording your greeting message (KX-TGD530 series)

You can record your own greeting message instead of using a pre-recorded greeting message. See page 28 for details.

- 1 [MENU]#302
- 2 [↕]: "Yes" → [SELECT]
- 3 Record a greeting message. → [STOP]  
→ [OFF]





## Other settings

### Dialing mode



- 1 [MENU]#120
- 2 [↕]: Select the desired setting. →  
[SAVE] → [OFF]

# Making/Answering Calls

## Making calls



1. Lift the handset and then dial the phone number.
  - To correct a digit, press [CLEAR].
2.  or 
  - To adjust the receiver or speaker volume, press  or  repeatedly.
3. When you finish talking, press [OFF].

Note:

- To switch to the speaker, press . To switch back to the receiver, press  / .
- In step 1, you can store the dialed phone number to the phonebook by pressing [SAVE].

## Making a call using the redial list:



The last 5 phone numbers dialed are stored in the redial list.

1.  REDIAL
2.  : Select the desired entry. -> 



## Pause (for PBX/long distance service users):

A pause is sometimes required when making calls using a PBX or long distance service. When storing a calling card access number and/or PIN in the phonebook, a pause is also needed.

Example: If you need to dial the line access number “9” when making outside calls with a PBX:

1. 9 ->  (Pause)
2. Dial the phone number. -> 



## Answering calls

1. Lift the handset and then press  or  when the unit rings.
2. When you finish talking, press [OFF].

Auto talk: You can answer calls simply by lifting the handset

Temporary handset ringer off: Press  (left soft key).

## Adjusting the ringer volume

- Handset: Press  or  repeatedly while ringing.
  - To turn the ringer off, press  repeatedly.
- Base unit\*1: \*1 KX-TGD530 series
  - Press + or - repeatedly. To turn the ringer off, press and hold - until the unit beeps.



## One-touch ringer off for the handset:

Press and hold 0 (  ) until the unit beeps to turn the ringer off. While the ringer is turned off, the handset will not ring for calls.

- You can turn the ringer on again by pressing and holding 0 (  ) until the unit beeps.

## Useful features during a call

### Hold

1. Press [MENU] during an outside call.
2. : "Hold" a MSELECTN
3. To release hold, press .

- Another handset user can take the call by pressing .

### Mute

1. Press [MUTE] during a call.
2. To return to the call, press [MUTE].

## Flash

[FLASH] allows you to use the special features of your host PBX.

### For call waiting or Call Waiting Caller ID service users

To use call waiting or Call Waiting Caller ID, you must first subscribe with your phone service provider.

This feature allows you to receive calls while you are already talking on the phone. If you receive a call while on the phone, you will hear a call waiting tone.

If you subscribe to both Caller ID and Call Waiting with Caller ID services, the 2nd caller's information is displayed on the unit that is in use after you hear the call waiting tone.

1. Press [CALL WAIT] to answer the 2nd call.
2. To switch between calls, press [CALL WAIT].



### Temporary tone dialing (for rotary/pulse service users)

Press  before entering access numbers which require tone dialing.

## Call share

While you are on an outside call, another unit can join the conversation. Only 2 units can join an outside call.

### Transferring calls, conference calls

1. During an outside call, press [MENU].
2. : "Intercom" → [SELECT]
3. : Select the desired unit. → [SELECT]
4. Wait for the paged party to answer.
  - If the paged party does not answer, press [BACK] to return to the outside call.
5. To complete the transfer:

Press [OFF].

To establish a conference call:

[MENU] → : "Conference" → [SELECT]



- To leave the conference, press [OFF].
- To put the outside call on hold: [MENU] → : "Hold" → [SELECT]

To resume the conference: [MENU] → : "Conference" → [SELECT]

To cancel the conference: [MENU] → : "Stop conference" → [SELECT]

## Intercom

### Making an intercom call

1. MENU] → : "Intercom" → [SELECT]
2. : Select the desired unit. → [SELECT]

## Call Block

You can press the [CALL BLOCK] button in the following situations to disconnect the current call and add a phone number to the call block list:

- when an incoming call is being received
- when an incoming call is being recorded by the answering system\*1
- when talking on an outside call

\*1 KX-TGD530 series

Once a phone number has been added to the call block list, the unit will block calls from that phone number in the future.

1. Press [CALL BLOCK] under the situations shown above.
2. Confirm the call block number and press [YES].
  - The call block number is stored in the call block list, "Caller blocked" is displayed, and then the call is disconnected.

Note:

- If the call has no phone number, the call is blocked but it is not stored in the call block list.
- The call block feature is not available for intercom calls or calls received by call waiting.
- Blocked calls are logged in the caller list.

## Storing unwanted callers

The unit can block calls by storing the desired items in the call block list beforehand (Caller ID subscribers only).

- "Block a single number": The unit blocks calls from specific phone numbers stored in the call block list.
- "Block range of numbers": The unit blocks calls that begin with a number stored in the call block list, such as a toll-free phone number prefix or certain area codes.

- “Block unknown CID”: The unit blocks calls that have no phone number

Single phone numbers and ranges of numbers can be stored in the call block list up to 150 items in total

Blocking unwanted callers: When a call is received, the unit rings once\*1 while caller information is being received. If the caller’s phone number matches an entry in the call block list, the unit emits no sound to the caller, and disconnects the call. \*1 If you do not want this one ring to sound, select “No” in “Turning the first ring on/ off

### Storing a single phone number Important:

- We recommend storing 10 digits (including the area code). If only 7 digits are stored, all numbers that have the same last 7 digits will be blocked.

### Adding call blocked numbers from the caller list

1. **[▼]** CID
2. **[↕]**: Select the desired entry to be blocked.
  - To edit the number: [MENU] -> **[↕]**: “Edit” -> [SELECT] Press [EDIT] repeatedly until the phone number is shown in the 10-digit format. -> [SAVE] -> **[↕]**: “Call block” -> [SELECT] -> Go to step 4.
3. [CALL BLOCK]
4. **[↕]**: “Yes” a [SELECT]
5. Edit the phone number if necessary (24 digits max.). -> [SAVE] -. [OFF]

### Adding call blocked numbers manually

- 1 [CALL BLOCK]
  - 2 **[↕]**: “Block a single number” → [SELECT]
  - 3 [MENU] → **[↕]**: “Add” → [SELECT]
- 4 Enter the phone number (24 digits max.).  
→ [SAVE] → [OFF]

### Storing a range of number

1. [CALL BLOCK]
2. **[↕]**: “Block range of numbers” → [SELECT]
3. [MENU] → **[↕]**: “Add” → [SELECT]

4. Enter the desired number (2-8 digits). → [SAVE] → [OFF]

### **Blocking incoming calls that have no phone number**

You can block calls when no phone number is provided, such as private callers or out of area calls.

1. [CALL BLOCK]
2. **[↕]**: “Block unknown CID” → [SELECT]
3. **[↕]**: Select the desired setting. → [SAVE] → [OFF]

### **Turning the first ring on/off**

You can choose whether the first ring sounds when a call is received.

Yes” (default): The first ring for all calls will be heard, including calls from blocked phone numbers.

No”): The first ring is muted for all calls. If this setting is selected, the unit will never ring for calls from blocked phone numbers.

1. [CALL BLOCK]
2. **[↕]**: “One ring for blocked call” → [SELECT]
3. **[↕]**: Select the desired setting. → [SAVE] → [OFF]

### **Viewing/editing/erasing call block numbers**

1. [CALL BLOCK]
2. **[↕]**: “Block a single number” or Block range of numbers” → [SELECT]
3. **[↕]**: Select the desired entry.
4. To edit a number: [EDIT] → Edit the number. → [SAVE] → [OFF]

To erase a number:

[ERASE] :→ **[↕]** “Yes” →[SELECT] → [OFF]

### **Erasing all call block numbers**

1. [CALL BLOCK]
2. **[↕]**: “Block a single number” or Block range of numbers” → [SELECT]
3. [MENU] → **[↕]**: “Erase all” → [SELECT]
4. **[↕]**: “Yes” → [SELECT]
5. **[↕]**: “Yes” → [SELECT] → [OFF]

## Phonebook

You can add 100 names (16 characters max.) and phone numbers (24 digits max.) to the phonebook.

### Adding phonebook entries

- 1 → [MENU]
- 2 : "Add new entry" → [SELECT]
- 3 Enter the party's name. → [OK]
- 4 Enter the party's phone number. → [OK]
- 5 : Select the desired group. → [SELECT] 2 times → [OFF]

### Entering characters

Press the dial key that corresponds to the desired character. Press repeatedly to scroll through the available characters.

The following operations are also available.

Key	Operation
	Switch between the uppercase and lowercase (A ↔ a)
	Move the cursor
[CLEAR]	Erase the character or number <ul style="list-style-type: none"><li>• To erase all, press and hold it.</li></ul>

- To enter another character that is located on the same dial key, first press to move the cursor to the next space.
- If you do not press any dial key within 2 seconds after entering a character, the character is fixed and the cursor moves to the next space.

### Storing a redial list number to the phonebook

1. REDIAL
2. : Select the desired entry. → [SAVE]
3. To store the name, continue from step 3, 'Editing entries', page 18.

### Storing caller information to the phonebook

1. CID

2. **[↕]**: Select the desired entry. → [MENU]
  - To edit the number: MbN: "Edit" → [SELECT]
    - Press [EDIT] repeatedly until the phone number is shown in → the desired format. → [SAVE] → **[↕]**: "Phonebook" → [SELECT] Go to step 4.
3. **[↕]**: "Save phonebook" → [SELECT]
4. Continue from step 3, "Editing entries", page 18.

## Groups

You can assign your phone entries to groups for each searching. You can assign a ringtone to each group to help identify incoming calls (Caller ID required).

### Changing group names/setting ringer ID

- 1 **[←] ☐ → [MENU]**
- 2 **[↕]: "Group" → [SELECT]**
- 3 **[↕]: Select the desired group. → [SELECT]**
- 4 **To change group names**  
**[↕]: "Group name" → [SELECT] →**  
 Edit the name. → **[SAVE]**  
**To set group ringer tone**

**[↕]: Select the current setting of the group ringer tone. → [SELECT] → [↕]:**  
**Select the desired ringer tone. → [SAVE]**

- 5 **[OFF]**

### Finding and calling from a phonebook entry

- 1 **[←] ☐**
- 2 **[↕]: Select the desired entry.**
- 3 **[↩]**

### Editing entries

1. Find the desired entry (page 18).
2. [MENU] → **[↕]**: "Edit" → [SELECT]
3. Edit the name if necessary. → [OK]
4. Edit the phone number if necessary → [OK]
5. **[↕]**: Select the desired group (page 17). → [SELECT]2 times a MOFFN

## Erasing an entry

Find the desired entry (page 18).

[MENU] → [↕]: "Erase" → [SELECT]

[↕]: "Yes" → [SELECT] → [OFF]

## Chain dial

This feature allows you to dial phone numbers in the phonebook while you are on a call. This feature can be used, for example, to dial a calling card access number or bank account PIN that you have stored in the phonebook, without having to dial manually.

1. During an outside call, press [◀] [☐].
  2. [↕] Select the desired entry.
  3. Press [CALL] to dial the number. pauses after the number and PIN as necessary (page 13).
- If you have rotary/pulse service, you need to press [✳] before pressing [◀] [☐] in step to change the dialing mode temporarily to tone. When adding entries to the phonebook, we recommend adding [✳] to the beginning of phone numbers you wish to chain dial (page 17).

## Speed dial

You can assign 1 phone number to each of the dial keys (1 to 9) on the handset.

### Adding phone numbers to speed dial keys

#### ■ By entering phone numbers:

- 1 Press and hold the desired speed dial key ([1] to [9]). → [ADD]
- 2 [↕]: "Manual" → [SELECT]
- 3 Enter the party's name. → [OK]
- 4 Enter the party's phone number. → [OK] → [SELECT] → [OFF]

#### ■ From the phonebook:

- 1 Press and hold the desired speed dial key ([1] to [9]). → [ADD]
- 2 [↕]: "Phonebook" → [SELECT]
- 3 [↕]: Select the desired entry. → [SAVE] → [OFF]

## Editing an entry

- 1 Press and hold the desired speed dial key (1 to 9). → **[MENU]**
- 2 **[↕]**: "Edit" → **[SELECT]**
- 3 Edit the name if necessary. → **[OK]**
- 4 Edit the phone number if necessary. → **[OK]** → **[SELECT]** → **[OFF]**

### Erasing an entry

- 1 Press and hold the desired speed dial key (1 to 9). → **[MENU]**
- 2 **[↕]**: "Erase" → **[SELECT]**
- 3 **[↕]**: "Yes" → **[SELECT]** → **[OFF]**

### Making a call

Press and hold the desired speed dial key (1 to 9). →



## Programming

### Menu list

- Scrolling through the display menus: [MENU] -> Press **[▲]** or **[▼]** to select the desired main menu. -> **[SELECT]** OR
- Using the direct command code: [MENU] -> Enter the desired code.
- Example: Press [MENU] #101.
  - To exit the operation, press [OFF]

## Display menu tree and direct command code table

Main menu: ☎ “Phonebook”

Operation	Code	Page
Viewing the phonebook entry.	#280	18

Main menu: →) “Caller list”

Operation	Code	Page
Viewing the caller list.	#213	26

Main menu: ☎ “Answering device”<sup>1</sup>

Sub-menu 1	Sub-menu 2	Settings <Default>	Code	Page
Play new message	–	–	#323	29
Play all message	–	–	#324	29
Erase all message	–	–	#325	–
Greeting	Record greeting	–	#302	28
	Check greeting	–	#303	28
	Pre-recorded	–	#304	28
Settings	Ring count	Toll saver 2-7 rings <4 rings>	#211	30
	Recording time	<3 min> 1 min Greeting only <sup>2</sup>	#305	31
	Remote code	<111>	#306	29
	Screen call	<On> Off	#310	30
Answer on	–	–	#327	–
Answer off	–	–	#328	–

Main menu:  "Voicemail access"

Operation	Code	Page
Listening to voicemail messages.	#330	32

Main menu:  "Intercom"

Operation	Code	Page
Paging the desired unit.	#274	14

Main menu:  "Set date & time"

Sub-menu 1	Sub-menu 2	Settings <Default>	Code	Page
Date and time	-	-	#101	12
Memo alarm	Alarm1-3	<Off> Once Daily Weekly	#720	24
Time adjustment <sup>*3</sup>	-	<Caller ID auto> Manual	#226	-

Main menu:  "Speed dial"

Operation	Code	Page
Viewing the speed dial entry.	#261	18

Main menu:  "Settings"

Sub-menu 1	Sub-menu 2	Settings <Default>	Code	Page
Ring adjustments	Ringer volume (Handset)	Off-6 <6>	#160	-
	Ringer tone <sup>*4</sup> (Handset)	<Tone 1>	#161	-
	Silent mode	On/Off - On - <Off>	#238	25
		Start/End - <11:00 PM/ 06:00 AM>	#237	25
		Select group Group 1-9	#241	25

Sub-menu 1	Sub-menu 2	Settings <Default>	Code	Page			
Set date & time	Date and time	–	#101	12			
	Memo alarm – Alarm1-3	<Off> Once Daily Weekly	#720	24			
	Time adjustment <sup>*3</sup>	<Caller ID auto> Manual	#226	–			
Talking caller ID <sup>*1</sup>	Handset	<On> Off	#162	26			
	Base unit	On <Off>	#*162				
Key detector setting <sup>*5</sup> – 1: Add new device (for Detector1) <sup>*6</sup> – 2: Add new device (for Detector2) – 3: Add new device (for Detector3) – 4: Add new device (for Detector4)	Change name	Detector1	#6561	–			
		Detector2 <sup>*7</sup>	#6562 <sup>*7</sup>				
		Detector3 <sup>*7</sup>	#6563 <sup>*7</sup>				
		Detector4 <sup>*7</sup>	#6564 <sup>*7</sup>				
	Registration	–	#6571 #6572 <sup>*7</sup> #6573 <sup>*7</sup> #6574 <sup>*7</sup>	–			
		Deregistration	–	#6581 #6582 <sup>*7</sup> #6583 <sup>*7</sup> #6584 <sup>*7</sup>	–		
			Call block	Block a single number	–	#217	15
				Block range of numbers	–		16
	Block unknown CID			Block <Unblock>	#240	16	
	One ring for blocked call	<Yes> No		#173	16		
	Speed dial	–	–	#261	18		
	Record greeting <sup>*1</sup>	–	–	#302	28		
Voicemail	Save VM access#	–	#331	32			
	VM tone detect	<On> Off	#332	32			
LCD contrast	–	Level 1–4 <2>	#145	–			

Sub-menu 1	Sub-menu 2	Settings <Default>	Code	Page
Handset name	–	–	#104	25
Display name	–	On <Off>	#105	25
Key tone	–	<On> Off	#165	–
Caller ID edit	–	<On> Off	#214	26
Auto talk	–	On <Off>	#200	13
Set tel line	Set dial mode	<Tone> Pulse	#120	12
	Set flash time	80 ms 90 ms 100 ms 110 ms 160 ms 200 ms 250 ms 300 ms 400 ms 600 ms <700 ms> 900 ms	#121	14
	Set line mode <sup>*8</sup>	A <B>	#122	–
Call sharing	–	<On> Off	#194	14
Registration	Register handset	–	#130	25
	Deregistration <sup>*2</sup>	–	#131	25
Change language	Display	<English> Español	#110	12
	Announcement	<English> Español	#112	12

Main menu: ? “Customer support”

Operation	Code	Page
Displaying customer support Web address.	#680	–

Main menu: (⊕) “Key detector”<sup>\*5</sup>

Sub-menu 1	Sub-menu 2	Settings <Default>	Code	Page
Search	–	–	#655	–
Battery check	–	–		

\*1 KX-TGD530 series

\*2 This menu is not displayed when scrolling through the display menus. It is only available in direct command code.

\*3 This feature allows the unit to automatically adjust the date and time each time caller information including date and time is received. To turn this feature on, select

“Caller ID auto”. To turn this feature off, select “Manual”. (Caller ID subscribers only) To use this feature, set the date and time first

\*4 The preset melodies in this product (“Tone 3” - “Melody 10”) are used with permission of © 2004 - 2013 Copyrights Vision Inc.

\*5 This setting is available when you have the key detector (KX-TGA20). Read the installation manual for more information on the key detector.

\*6 For models with supplied key detectors, the display shows “1: Detector1”.

\*7 If you register 2 or more key detectors.

\*8 Generally, the line mode setting should not be changed. This setting automatically maintains receiver volume at the proper level depending on the current telephone line condition. Set the line mode to “A” if telephone line condition is not good.

## Alarm

An alarm sounds at the set time for 1 minute and is repeated 5 times at 5 minute intervals (snooze function). A text memo can also be displayed for the alarm. A total of 3 separate alarm times can be programmed for each handset. You can set one of 3 different alarm options (once, daily, or weekly) for each alarm time.

- 1 **[MENU]** **#** **7** **2** **0**
- 2 **[↑]**: Select the desired alarm. →  
**[SELECT]**
- 3 **[↑]**: Select the desired alarm option. →  
**[SELECT]**
- 4 Proceed with the operation according to your selection in step 3.
  - **Once:**  
Enter the desired month and date. →  
**[OK]**
  - **Weekly:**  
**[↑]**: Select the desired day of the week and press **[SELECT]**. → **[OK]**
- 5 Set the desired time.
- 6 **[\*]**: Select “AM” or “PM”. → **[OK]**
- 7 Enter a text memo (10 characters max.). → **[OK]**
  
- 8 **[↑]**: Select the desired alarm tone. →  
**[SELECT]**
- 9 **[↑]**: Select the desired snooze setting. → **[SAVE]**
- 10 **[SELECT]** → **[OFF]**

## Silent mode

Silent mode allows you to select a period of time during which the handset will not ring for outside calls. This feature is useful for time periods when you do not want to be disturbed, for example, while sleeping. Silent mode can be set for each unit.

Using the phonebook's group feature page 17), you can also select groups of callers whose calls override silent mode and ring the unit (Caller ID subscribers only).

### Turning silent mode on/off

- 1 [MENU] #238
- 2 [↕]: Select the desired setting. → [SAVE]
- 3 Follow the directions on the display to complete the operation.

### Changing the start and end time

- 1 [MENU] #237
- 2 Follow the directions on the display to complete the operation.

### Selecting groups to bypass silent mode

- 1 [MENU] #241
- 2 [↕]: Select the desired groups. → [SELECT]
  - "✓" is displayed next to the selected group numbers.
  - To cancel the selected group:  
[↕]: Select the group. → Press [SELECT] again. "✓" disappears.
- 3 [SAVE] → [OFF]

### Other programming

#### Changing the handset name

- 1 [MENU] #104
- 2 Enter the desired name. → [SAVE] → [OFF]

#### Displaying the handset name

You can select whether or not the handset name is displayed in standby mode. The default setting is "Off".

- 2 [↕]: Select the desired setting. → [SAVE] → [OFF]

#### Registering a handset to the base unit

If for some reason the handset is not registered to the base unit, re-register the handset.

1. Handset: [MENU] #130
2. Base unit:



Press and hold [LOCATOR] for about 5 seconds.

- If all registered handsets start ringing, press [LOCATOR] again to stop, then repeat this step.

3. Handset:

- Press [OK], then wait until a long beep sounds.

### **Deregistering a handset**

1. [MENU] #131 • All handsets registered to the base unit are displayed.
2.  Select the handset you want to cancel. → [SELECT]
3.  "Yes" → [SELECT] → [OFF]

## **Caller ID Service**

### **Using Caller ID service**

Important:

- This unit is Caller ID compatible. To use Caller ID features, you must subscribe to a Caller ID service. Contact your phone service provider for details.

### **Caller ID features**

When an outside call is being received, the caller information is displayed. Caller information for the last 50 callers is logged in the caller list from the most recent call to the oldest.

- If the unit cannot receive caller information, the following is displayed:
  - "Out of area": The caller dials from an area which does not provide a Caller ID service.
  - "Private caller": The caller requests not to send caller information.
  - "Long distance": The caller makes a long distance call.
- If the unit is connected to a PBX system, caller information may not be properly received. Contact your PBX supplier.

### **Talking Caller ID (KX-TGD530 series)**

#### **Handset / Base unit**

This feature lets you know who is calling without looking at the display. To use this feature, you must:

- subscribe to a Caller ID service of your phone service provider.

- turn this feature on

When caller information is received, the handsets and/or base unit announce the caller's name or phone number received from your phone service provider following every ring.





- Name pronunciation may vary. This feature may not pronounce all names correctly.
- Caller ID service has a limit of how many characters can be displayed. If the caller's name is too long, the unit may not be able to display or announce the entire name.

#### Phonebook name announcement





- When caller information is received and it matches a phone number stored in the phonebook, the stored name in the phonebook is announced.

### Caller list

#### Viewing the caller list and calling back

1.  CID
2. Press  to search from the most recent call, or  to search from the oldest call.
3. To call back, press .

#### Editing a caller's phone number

1.  CID
2. : Select the desired entry. -> [MENU]
3. : "Edit" -> [SELECT]
4. Press [EDIT] repeatedly until the phone number is shown in the desired format.
5. 

#### Auto edit feature

- After you edit and call back a phone number in the caller list, the unit remembers the way you edited the phone number and edits subsequent calls from the same area code in the same way.

- Note:
  - This feature can be set for each unit

### Erasing selected caller information

1. **【▽】** CID
2. **【↕】**: Select the desired entry.
3. [ERASE] -> **【↕】**: “Yes” -> [SELECT] -> [OFF]

## Answering System

### Answering system (KX-TGD530 series)

The answering system can answer calls and record caller messages. If you do not want to record messages, select “Greeting only” as the recording time setting

**Recording capacity:** The total recording time is about 17 minutes, including your greeting message. Up to 64 messages can be recorded. Note:

- When message memory becomes full:
  - “Messages full” is shown on the handset display.
  - The message counter on the base unit flashes if the answering system is turned on.

### Turning the answering system on/off

- Base unit: Press [ANSWER ON/OFF] to turn on/off the answering system.

### Greeting message

#### Recording your greeting message

1. [MENU] #302
2. **【↕】**: “Yes” -> [SELECT]
3. After a beep sounds, hold the handset and speak clearly into the microphone.
4. Press [STOP] to stop recording. -> [OFF]

**Using a pre-recorded greeting message:** The unit provides 2 pre-recorded greeting messages:

- If you reset to pre-recorded greeting or do not record your own greeting message, the unit plays a pre-recorded greeting asking callers to leave a message.

- If the message recording time is set to “Greeting only”, callers’ messages are not recorded and the unit plays a different pre-recorded greeting message asking callers to call again.

### Resetting to a pre-recorded greeting message



1. [MENU] #304
2. [YES] → [OFF]

### Playing back the greeting message

1. [MENU] #303
2. To exit, press [OFF]

### Listening to messages

#### Using the base unit:

When new messages have been recorded, the message indicator (  ) on the base unit flashes. Press  (PLAY).

- During playback, the message indicator (  ) on the base unit lights.
- New messages will be played. If there are no new messages, old messages will be played.

#### Operating the answering system during playback

Key	Operation
[+] or [-]	Adjust the speaker volume
[⏮]	Repeat message
[⏭]	Skip message
[▶■] (STOP)	Stop playback
[ERASE]	Erase currently playing message

#### Erasing all messages

- Press [ERASE] 2 times while the unit is not in use.

#### Using the handset

When new messages have been recorded, “New message” is displayed.

- 1 To listen to new messages:  
**[MENU]#323**  
 To listen to all messages:  
**[MENU]#324**
- 2 When finished, press **[OFF]**.

### Operating the answering system

Key	Operation
<b>[▲]</b> or <b>[▼]</b>	Adjust the receiver/speaker volume (during playback)
<b>1</b> or <b>[◀]</b>	Repeat message (during playback)
<b>2</b> or <b>[▶]</b>	Skip message (during playback)
<b>3</b>	Enter the “ <b>Settings</b> ” menu
<b>4</b>	Play new messages
<b>5</b>	Play all messages
<b>6</b>	Play greeting message
<b>7 6</b>	Record greeting message

Key	Operation
<b>8</b>	Turn answering system on
<b>[PAUSE]</b>	Pause message*1
<b>9</b> or <b>[STOP]</b>	Stop recording Stop playback
<b>0</b>	Turn answering system off
<b>*4</b>	Erase currently playing message
<b>*5</b>	Erase all messages
<b>*6</b>	Reset to a pre-recorded greeting message

\*1 To resume playback:  
**[↕]: “Playback” → [SELECT]**

### Calling back (Caller ID subscribers only)

1. Press **[PAUSE]** during playback.
2. **[↕]: “Call back” → [SELECT]**

### Remote operation

You can use a touch-tone phone to call the unit while away from home and listen to messages.

### Remote access code

For security, a 3-digit remote access code must be entered when operating the answering system remotely. The default setting is “111”.

- 1 **[MENU]#306**
- 2 Enter the desired 3-digit remote access code.
  - To deactivate remote operation, press **[\*]**.
- 3 **[SAVE] → [OFF]**

### Using the answering system remotely

1. Dial your phone number from a touch-tone phone.
2. After the greeting message starts, enter your remote access code.
3. Follow the voice guidance prompts as necessary or control the unit using remote commands (page 30).
4. When finished, hang up.

### Voice guidance

- When the English voice guidance is selected

During remote operation, the unit’s voice guidance starts and prompts you to press to perform a specific operation, or press to listen to more available operations.

- When the Spanish voice guidance is selected

To start the voice guidance, press 9. The voice guidance announces the available remote commands (page 30).

### Remote commands

Key	Operation
<b>[1]</b>	Repeat message (during playback)
<b>[2]</b>	Skip message (during playback)
<b>[4]</b>	Play new messages
<b>[5]</b>	Play all messages
<b>[9]</b>	Stop playback* <sup>1</sup> Start voice guidance* <sup>2</sup>
<b>[0]</b>	Turn answering system off
<b>[*][4]</b>	Erase currently playing message
<b>[*][5]</b>	Erase all messages
<b>[*][#]</b>	End remote operation (or hang up)

### Turning on the answering system remotely

1. Dial your phone number from a touch-tone phone.



2. Let the phone ring 15 times.

- A long beep is heard.

3. Enter your remote access code within 10 seconds after the long beep.

- The greeting message is played back.
- You can either hang up, or enter your remote access code again and begin remote operation (page 29).

## Answering system settings

### Call screening

While a caller is leaving a message, you can listen to the call through the unit's speaker.

- 1 [MENU]#310
- 2 [↕]: Select the desired setting. →  
[SAVE] → [OFF]

### Number of rings before the unit answers a call

You can change the number of times the phone rings "Ring count" before the unit answers calls. You can select 2 to 7 rings, or Toll saver".

The default setting is "4 rings".

Toll saver": The unit's answering system answers at the end of the 2nd ring when new messages have been recorded, or at the end of the 5th ring when there are no new messages.

- 1 [MENU]#211
- 2 [↕]: Select the desired setting. →  
[SAVE] → [OFF]

### Caller's recording time

You can change the maximum message recording time allowed for each caller.

- 1 [MENU]#305
- 2 [↕]: Select the desired setting. →  
[SAVE] → [OFF]

### Selecting "Greeting only"

You can select "Greeting only" which sets the unit to announce a greeting message to callers but not record messages.

Select "Greeting only" in step 2 on Caller's recording time", page 31.

## Useful Information

### Voicemail service

- In addition to your unit's answering system you may also have voicemail service from your phone service provider. Voicemail is an answering service that may be offered by your phone service provider. This service can also record calls when you are unavailable to answer the phone or when your line is busy. Messages are recorded on the phone company system and not on the unit's answering system.
  - To use the voicemail service rather than the unit's answering system, turn off the answering system
- If you have unit's answering system set to on and also the voicemail enabled, the system with least amount of rings will record the message first.
- Example: If the unit's answering system is set to 4 rings (page 30) and the voicemail answering system provided by your phone company is set to 6 rings (call your service provider), the unit's answering system will record the incoming call first.

### Storing the voicemail (VM) access number

You can store the phone number used to access your voicemail service.

1. [MENU]#331
2. Enter your access number. -> [SAVE] -> [OFF]

Note: When storing your voicemail access number and your mailbox password, press MDN



(Pause) to add pauses between the access number and the password as necessary. Contact your phone service provider for the required pause time.

Example

<u>1-222-333-4444</u>	<u>PPPP</u>	<u>8888</u>
VM access number	Pauses	Password

### To erase the voicemail access number

1. [MENU] #331
2. Press and hold [CLEAR] until all digits are erased. -> [SAVE] -> [OFF]

## **Voicemail (VM) tone detection**

- Your voicemail service provider sends special signals to the unit to let you know that you have new voicemail messages. If you hear a series of dial tones followed by a continuous dial tone after you press , you have new voicemail messages.
- The unit can detect these signals automatically. Turn this feature off in the following situations.
  - You do not subscribe to voicemail service.
  - Your phone is connected to a PBX.

## **Turning VM tone detection on/off**

1. [MENU] #332
2. MbN: Select the desired setting. -> [SAVE] -> [OFF]

## **Listening to voicemail messages**

1. [MENU]#330
  - The speakerphone turns on.
2. Follow the pre-recorded instructions.
3. When finished, hang up.

Note:

- You can also use the [ACCESS] soft key, if displayed, to play new voicemail messages.
- If the handset still indicates there are new messages even after you have listened to all new messages, turn it off by pressing and holding # until the handset beeps.

## **Wall mounting**

### **Base unit**

- 1 Lead the AC adaptor cord and telephone line cord through the hole in the wall mounting adaptor in the direction of the arrow.

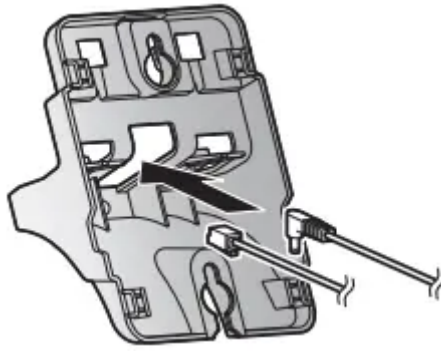

2 Tuck the telephone line cord inside the wall mounting adaptor (1). Connect the AC adaptor cord and telephone line cord (2)

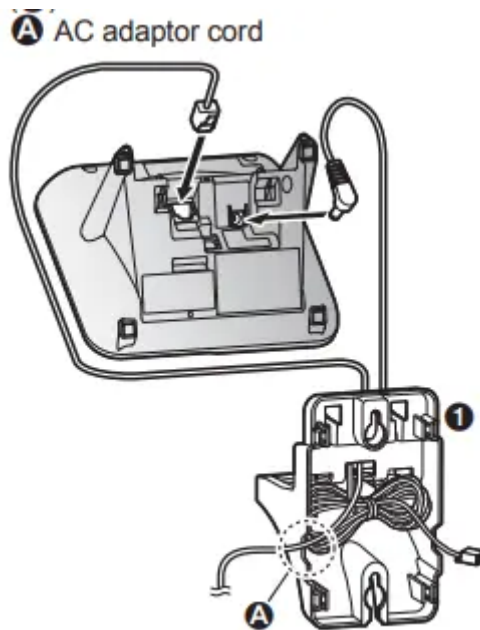

3 Insert the hooks on the wall mounting adaptor into holes (A) and (B) on the base unit.

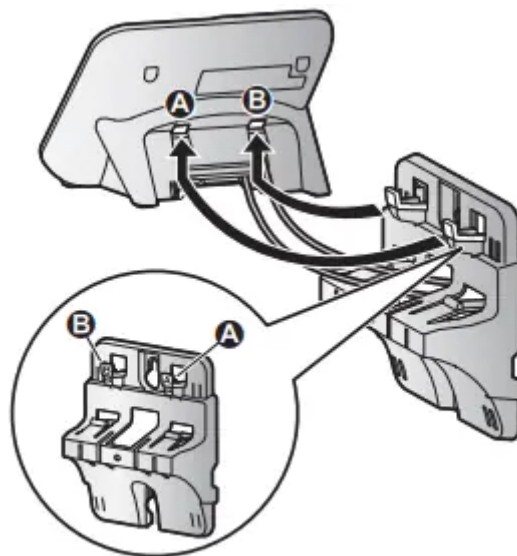

4 Adjust the adaptor to hold the base unit, then push it in the direction of the arrow until it clicks into place.

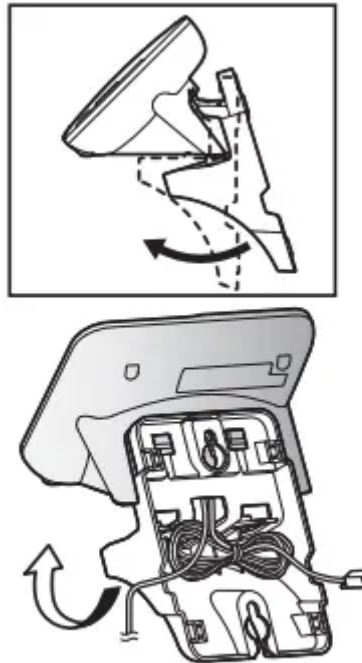

5 Mount the unit on a wall then slide down to secure in place.

**A** AC adaptor cord

This product is compliant with the following wall phone plate sizes (2 types).

**B** 83mm (3 1/4 inches) mm (4 inches)

Fit the slots of the unit onto the corresponding wall phone plate tabs for **D** and **E** respectively.

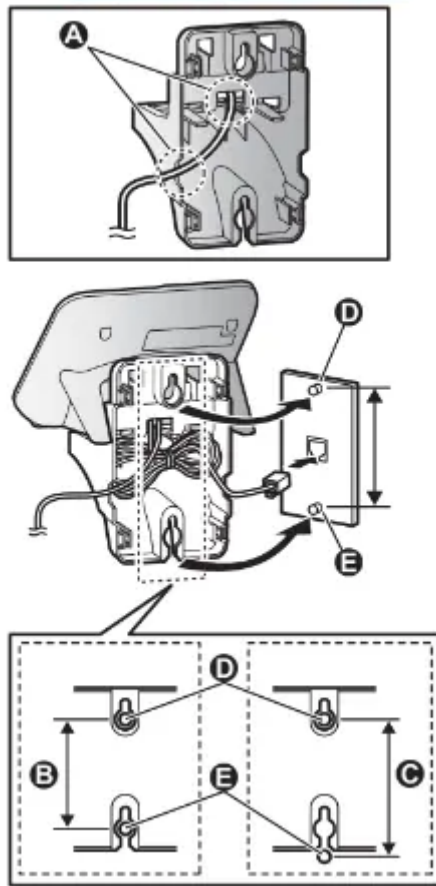

To remove the wall mounting adaptor

- While pushing down the release levers (1), remove the adaptor (2).

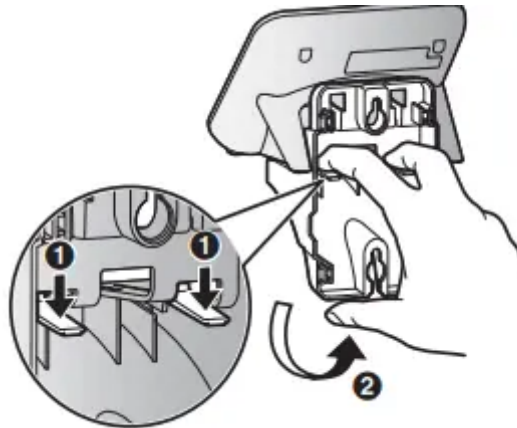

### Charger

- Drive the screws ( A ) (not supplied) into the wall.

**B** 27.2 mm (1 1/16 inches)

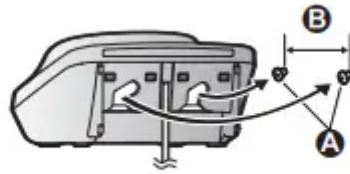

## Error messages

Display message	Cause/solution
Ask phone company for VM access #	<ul style="list-style-type: none"> <li>You have not stored the voicemail access number. Store the number (page 32).</li> </ul>
Main unit no power or No link. Re-connect base AC adaptor.	<ul style="list-style-type: none"> <li>Confirm the base unit's AC adaptor is connected to the unit and the power outlet correctly.</li> <li>The handset has lost communication with the base unit. Move closer to the base unit and try again.</li> <li>Unplug the base unit's AC adaptor to reset the unit. Reconnect the adaptor and try again.</li> <li>The handset's registration may have been canceled. Re-register the handset (page 25).</li> </ul>
Busy	<ul style="list-style-type: none"> <li>Other units are in use and the system is busy. Try again later.</li> </ul>
Check tel line	<ul style="list-style-type: none"> <li>The supplied telephone line cord has not been connected yet or not connected properly. Check the connections (page 9).</li> </ul>
Error!!	<ul style="list-style-type: none"> <li>Recording was too short. Try again.</li> </ul>
Invalid	<ul style="list-style-type: none"> <li>There is no handset registered to the base unit matching the handset number you entered.</li> <li>The handset is not registered to the base unit. Register the handset (page 25).</li> </ul>
Use rechargeable battery.	<ul style="list-style-type: none"> <li>A wrong type of battery such as alkaline or manganese was inserted. Use only the rechargeable Ni-MH batteries noted on page 4, 7.</li> </ul>

## Troubleshooting

If you still have difficulties after following the instructions in this section, disconnect the base unit's AC adaptor, then reconnect the base unit's AC adaptor. Remove the batteries from the handset, and then insert them into the handset again.

## General use

1. The handset does not turn on even after installing charged batteries.

- Place the handset on the base unit or charger to turn on the handset.

2. The unit does not work.

- Make sure the batteries are installed correctly
- Fully charge the batteries
- Check the connections
- Unplug the base unit's AC adaptor to reset the unit. Reconnect the adaptor and try again.
- The handset has not been registered to the base unit. Register the handset

3. I cannot hear a dial tone.



- The base unit's AC adaptor or telephone line cord is not connected. Check the connections.

4. Time on the unit has shifted.

- Incorrect time information from incoming Caller ID changes the time. Set the time adjustment to "Manual"

## Battery recharge

1. I fully charged the batteries, but

-  still flashes,
-  is displayed, or
- the operating time seems to be shorter.
  - Clean the battery ends (+, -) and the charge contacts with a dry cloth and charge again.
  - It is time to replace the batteries

## Making/answering calls, intercom



1.  is displayed.

- The handset is too far from the base unit. Move closer.
- The base unit's AC adaptor is not properly connected. Reconnect AC adaptor to the base unit.
- The handset is not registered to the base unit. Register it

2. Noise is heard, sound cuts in and out.

- You are using the handset or base unit in an area with high electrical interference. Re-position the base unit and use the handset away from sources of interference.
- Move closer to the base unit.
- If you use a DSL/ADSL service, we recommend connecting a DSL/ADSL filter between the base unit and the telephone line jack. Contact your DSL/ADSL provider for details.

3. The handset does not ring.

- The ringer volume is turned off. Adjust the ringer volume
- Silent mode is turned on. Turn it off
- The ringer volume is turned off by pressing and holding 0 (  ). Press and hold 0 (  ) again to turn it on

4. I cannot make a call.

- The dialing mode may be set incorrectly. Change the setting

**Caller ID/Talking Caller ID**

1. Caller information is not displayed.

- You must subscribe to Caller ID service. Contact your phone service provider for details.
- If your unit is connected to any additional telephone equipment such as a Caller ID box or cordless telephone line jack, plug the unit directly into the wall jack.
- If you use a DSL/ADSL service, we recommend connecting a DSL/ADSL filter between the base unit and the telephone line jack. Contact your DSL/ADSL provider for details.
- The name display service may not be available in some areas. Contact your phone service provider for details.

2. Caller information is displayed or announced late.

- Depending on your phone service provider, the unit may display or announce the caller's information at the 2nd ring or later.

3. Caller information is not announced.

- The handset or base unit's ringer volume is turned off. Adjust it
- The Talking Caller ID feature is turned off. Turn it on

- The number of rings for the answering system is set to “2 rings” or “Toll saver”. Select a different setting

### **Answering system**

1. The unit does not record new messages.

- The answering system is turned off. Turn it on
- The message memory is full. Erase unnecessary messages
- The recording time is set to “Greeting only”. Change the setting
- Your phone service provider’s voicemail service may be answering your calls before the unit’s answering system can answer your calls. Change the unit’s number of rings setting to a lower value, or contact your phone service provider.
- The answering system will not answer incoming calls while the other devices such as handsets are engaged in a call.

### **Voicemail**

1. “Voicemail msg. via phone co.” is shown on the handset display. How do I remove this message from the display?

- Listen your new voicemail messages. Depending on your voicemail service provider, you may need to erase all messages in your voice mailbox in order to remove this message.
- You can remove this message manually by pressing and holding # until the unit beeps.

### **Liquid damage**

1. Liquid or other form of moisture has entered the handset/base unit.

- Disconnect the AC adaptor and telephone line cord from the base unit. Remove the batteries from the handset and leave to dry for at least 3 days. After the handset/base unit are completely dry, reconnect the AC adaptor and telephone line cord. Insert the batteries and charge fully before use. If the unit does not work properly, contact an authorized service center.

#### **Warning**

This content is compiled from multiple sources and is provided for reference purposes only. It may not be complete or fully applicable to all situations. If you are unable to resolve your issue, please contact the product manufacturer or an authorized service provider for official support.