

Before you start

Sort and load

- Put one wash load in the dryer at a time.
- Do not mix heavy and lightweight items together.
- To improve drying efficiency for one or two items, add a dry towel to the load.
- For best results, untangle items before inserting them into the dryer. Tangled items may degrade the drying efficiency or cause the door to open.
- Overloading reduces the tumbling performance, resulting in uneven drying and wrinkling.
- Unless recommended on the care label, do not dry woolens or fiberglass items.
- Avoid drying unwashed items.
- Do not dry items soiled with oil, alcohol, gasoline, etc.

Functional prerequisite

Lint filter

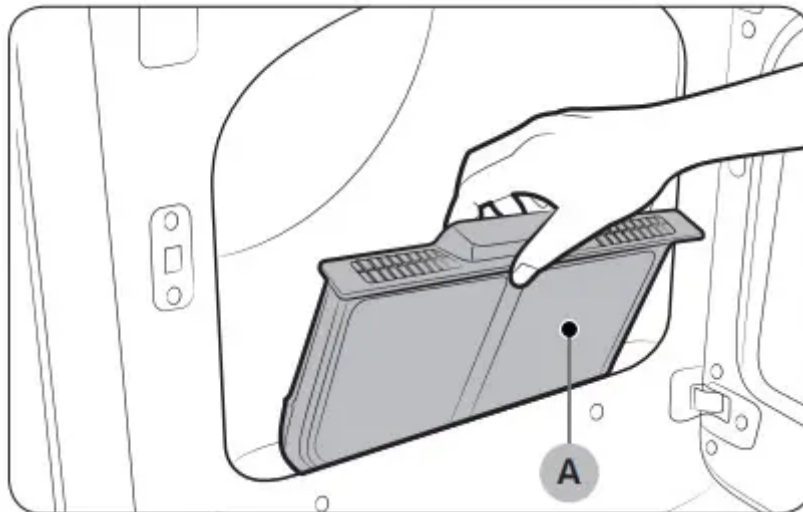

To prevent a risk of fire, make sure to clean the lint filter before or after every load.

1. Turn off the dryer.
2. Open the door and pull out the lint filter (A) from inside the drum.
3. Remove the lint, and then clean the lint filter.
4. Reinsert the lint filter, and then close the door.

Rack Dry (DVE(G)54R7600* models only)

Some models come with a drying rack which is inserted into the drum at the factory. If your model came with a drying rack, remove the rack from the drum before you use the dryer for the first time. To remove the rack, pull the rack straight up, and then take it out of the drum. Remove the drying rack from its packaging and store the rack for later use.

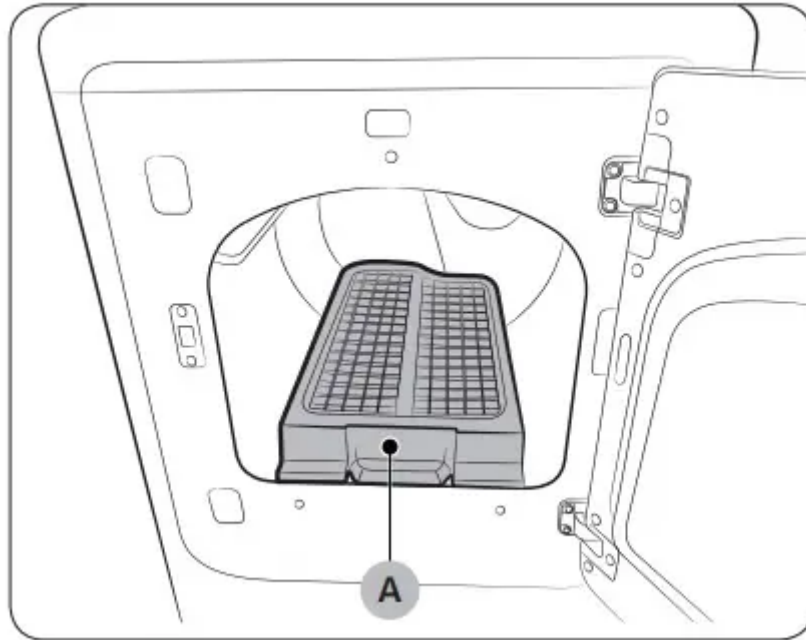

If a drying rack is not provided, you can purchase it at a local Samsung service center. (Part Code : DC61-03052B) To use the drying rack, follow these steps:

1. Insert the drying rack (A) inside the tumbler with the filter handle to the front.
2. Insert the rear legs of the drying rack into the recessed areas of the rear wall, and then press down the middle of the drying rack to secure it in place.
3. Put items to dry on the rack. Make sure to leave space between the items for air flow.
4. Press Rack Dry, and then select the drying time.
5. When the items are dry, remove the them from the dryer, and then remove the drying rack.

Drying rack drying suggestions

Item	Cycle settings
Washable sweaters (block to shape and lay flat on rack)	TIME DRY with the Extra Low temperature setting
Stuffed toys (cotton or polyester fiber-filled)	
Stuffed toys (foam or rubber-filled)	AIR FLUFF
Foam rubber pillows	
Sneakers	

Operations

Control panel

DVE(G)54R7600*

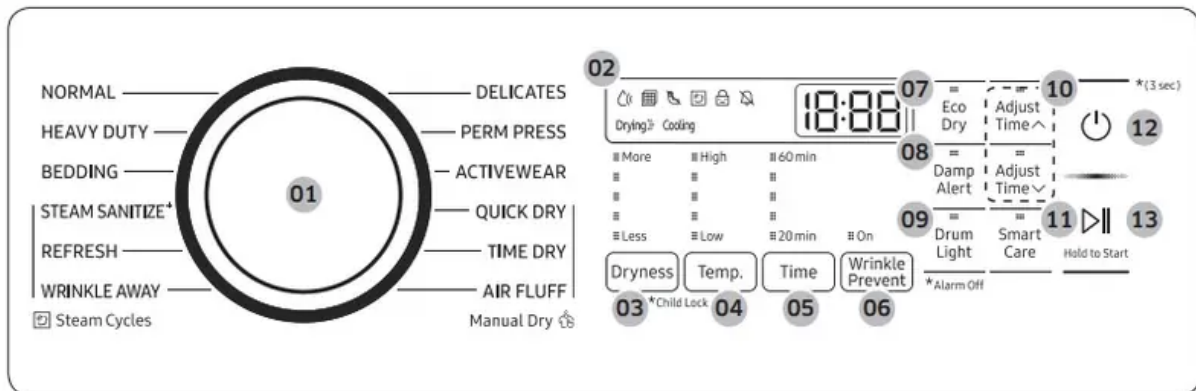

DVE(G)54R7200*

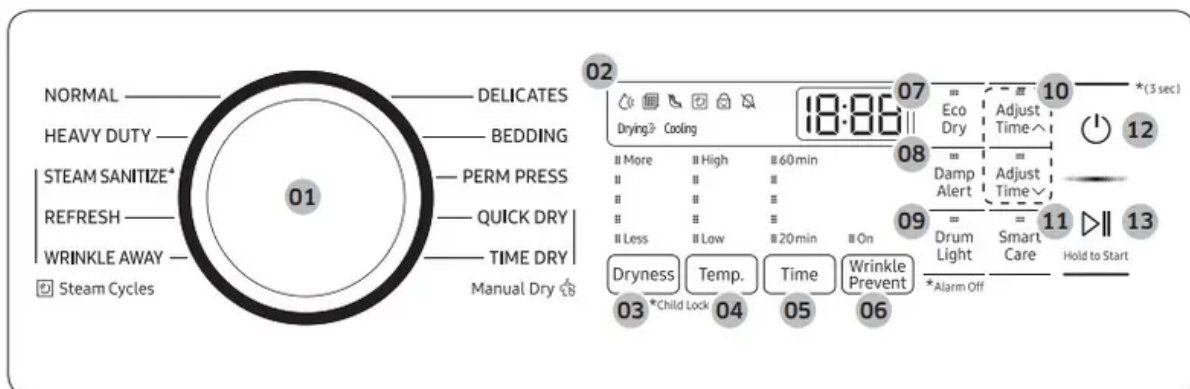

01 Cycle Selector	<p>Turn the Cycle Selector to select a desired cycle. When a cycle is selected, the cycle indicator lights up.</p> <ol style="list-style-type: none"> 1. Steam Cycles: The dryer sprays water into the drum to deodorize clothes and reduce static electricity and wrinkles. 2. Manual Dry: The drying time is fixed
02 Digital Graphic Display	<p>Displays all cycle information, including the cycle time, information code, and operating status.</p>
03 Dryness	<p>Press to select a dry level. You can select from 5 different options (Less to More). Please refer to following recommendations to select the appropriate dryness.</p> <ul style="list-style-type: none"> • For larger or bulkier loads, select More for complete dryness. • For items that needs to lay flat or hang to dry, use Less to partially dry items. <p>NOTE This option is not available with REFRESH, WRINKLE AWAY, STEAM SANITIZE , ACTIVEWEAR, TIME DRY, QUICK DRY, and AIR FLUFF.</p>
04 Temp	<p>Press to change the temperature of the current cycle. You can select from 5 different options (Low to High). Please select the appropriate temperature depending on the items in the load.</p> <ul style="list-style-type: none"> • High: For sturdy cottons or those labeled Tumble Dry. • Medium: For permanent press, synthetics, lightweight cottons, or items labeled Tumble Dry Medium. • Low: For heat sensitive items labeled Tumble Dry Low or Tumble Dry Warm. Provides the lowest heated drying temperature possible.
05 Time	<p>Press to adjust the drying time for the Manual Dry cycles. This is not available with the Sensor Dry cycles because the dryer determines the drying time by sensing the current moisture level of the load.</p>
06 Wrinkle Prevent	<p>Wrinkle Prevent provides approximately 180 minutes of intermittent tumbling in unheated air at the end of the cycle to reduce wrinkling. Press Wrinkle Prevent to activate this feature. The load is dry, and can be removed at any time during the Wrinkle Prevent cycle.</p>



07 Eco Dry	This function is available with NORMAL and TIME DRY. With the Eco Dry activated, drying takes a longer time but the power consumption is reduced. The drying time can be extended by up to 3 times depending on the temperature and load. The Eco Dry function is enabled by default.
08 Damp Alert	This alert is available for all Sensor Dry cycles except for SANITIZE and ACTIVEWEAR. Available dry levels are Normal, More, and Extra. If a load contains mixed fabrics, the Damp Alert indicator blinks when average dryness of the items in the load is 80 % dry. This lets you take items that you don't want fully dried or that dry quickly out of the dryer early while letting others continue to dry
09 Drum Light	Press to turn the interior lamp on or off. The lamp stays lit for 2 minutes after it has turned on, regardless of whether the power is on or off or the door is open or closed, and then turns off automatically.
10 Adjust Time	You can change the set time in the Manual Dry cycles (QUICK DRY, TIME DRY, AIR FLUFF, and WRINKLE RELEASE) and WRINKLE AWAY. To change the cycle time, press ^ or v until the desired time is displayed.
11 Smart Care	This function enables you to check the status of the dryer using a smartphone.
12 Power	Press to turn on/turn off the dryer.
13 Start/ Pause (Hold to Start)	Press to start or stop operation.

Simple steps to start

1. Press Power to turn the dryer on.
2. Turn the Cycle Selector to select a cycle.
3. Change the cycle settings (Dryness, Temp., and Time) as necessary.
4. Select desired options as necessary.
5. Press and hold Start/Pause (Hold to Start).

To change the cycle during operation

1. Press Start/Pause (Hold to Start) to stop operation.
2. Select a different cycle, and repeat steps 2-4 above if necessary.

3. Press and hold Start/Pause (Hold to Start) again to start the new cycle.

Cycle overview

Standard Cycles

Cycle	Description
NORMAL	For most fabrics including cottons and linens. If NORMAL is selected, the Eco Dry function is enabled by default. For more information, see Eco Dry in the “Control panel” section.
HEAVY DUTY	For drying items made out of heavy fabrics, such as jeans, corduroys, or work clothes, with high temperature heat.
BEDDING	For bulky items such as blankets, sheets, and comforters.
DELICATES	For heat-sensitive items at a low drying temperature.
PERM PRESS	For drying wrinkle-free cottons, synthetic fabrics, knits, and permanent press fabrics automatically.
ACTIVEWEAR (DVE(G)54R7600* models only)	For exercise wear and outdoor wear such as sports jerseys, training pants, water-repellent jackets, and other performance clothing. Thick fabrics like a zipper or velcro closure of a jacket, or training socks may not be completely dried.

Manual Dry

You can change the drying settings manually to your preference.

QUICK DRY	A quick drying cycle running for 30 minutes. The default cycle time is 30 minutes. However, you may manually change the cycle time if necessary.
TIME DRY	You can specify a cycle time in minutes. If TIME DRY is selected, the Eco Dry function is enabled by default. For more information, see Eco Dry in the “Control panel” section.
AIR FLUFF (DVE(G)54R7600* models only)	Tumbles the load in room temperature air.



Steam Cycles

Use steam to reduce wrinkling and odors on items.

Cycle	Description
STEAM SANITIZE+	Use to sanitize items by applying steam and high-temperature heat to the fabric. This cycle can make items soft and reduce smells. Confirm that the laundry load is wet or partially wet before starting this cycle.
REFRESH	Use to smooth out wrinkles and reduce odors in loads of one to four items. With this cycle selected, a small amount of water is sprayed into the dryer drum after several minutes of tumbling with heat. Confirm that the laundry load is dry.
WRINKLE AWAY	For best results, load 2-3 items at once. You can extend the drying time by a minimum of 20 minutes, depending on the item type or load. Confirm that the laundry load is dry.

Cycle chart

For best results, follow the load size recommendations for each dry cycle.

-  Large load: Fill the drum to about 3/4 full. Do not add items over this level as they need to tumble freely.
-  Medium load : Fill the drum to about 1/2 full.
-  Small load : Fill the drum with 3-5 items, not more than 1/4 full.

Cycle	Recommended items	Load size	Dry level
NORMAL	Cottons, work clothes, linens, mixed loads	●	Normal dry (Adjustable)
HEAVY DUTY	Heavy fabrics such as jeans, corduroys, heavy work clothes	●	Normal dry (Adjustable)
BEDDING	Bulky items such as blankets, sheets, comforters, pillows	●	Normal dry (Adjustable)
DELICATES	Underwear, blouses, lingerie	◐	Normal dry (Adjustable)
PERM PRESS	Shirts, synthetic fabrics, knits, wrinkle-free cottons, permanent press	◐	Normal dry (Adjustable)
ACTIVEWEAR (DVE(G)54R7600* models only)	Water-repellent wear, performance clothes, sports wear (Maximum : 4 lbs)	◐	Normal dry (Not adjustable)
QUICK DRY	Small loads	○	-
TIME DRY	Any load	●	-
AIR FLUFF (DVE(G)54R7600* models only)	Foam, rubber, plastic	◐	-
STEAM SANITIZE ⁺	Bedding, curtains, children's clothing	◐	Very dry (Not adjustable)
REFRESH	Shirts, trousers, comforters, pillows	○	-
WRINKLE AWAY	Shirts, trouser, blouses	○	-

NOTE

● : factory setting, ○ : can be selected

Cycle	Functions (Temp. Control)					Time
	High	⦿	⦿	⦿	Low	
NORMAL		●				
HEAVY DUTY	●					
BEDDING	●					
DELICATES					●	
PERM PRESS			●			
ACTIVEWEAR (DVE(G)54R7600* models only)		●				
QUICK DRY	●					○
TIME DRY	●	○	○	○	○	○
AIR FLUFF (DVE(G)54R7600* models only)						○
STEAM SANITIZE ⁺	●					
REFRESH	●					
WRINKLE AWAY	●					○



Cycle	Options				
	Adjust Time	Damp Alert	Eco Dry	Anti-Static	Wrinkle Prevent
NORMAL		<input type="radio"/>	<input type="radio"/>	<input type="radio"/>	<input type="radio"/>
HEAVY DUTY		<input type="radio"/>		<input type="radio"/>	<input type="radio"/>
BEDDING		<input type="radio"/>			<input type="radio"/>
DELICATES		<input type="radio"/>		<input type="radio"/>	<input type="radio"/>
PERM PRESS		<input type="radio"/>		<input type="radio"/>	<input type="radio"/>
ACTIVWEAR (DVE(G)54R7600* models only)					<input type="radio"/>
QUICK DRY	<input type="radio"/>				<input type="radio"/>
TIME DRY	<input type="radio"/>		<input type="radio"/>	<input type="radio"/>	<input type="radio"/>
AIR FLUFF (DVE(G)54R7600* models only)	<input type="radio"/>				<input type="radio"/>
STEAM SANITIZE ⁺					<input type="radio"/>
REFRESH					<input type="radio"/>
WRINKLE AWAY	<input type="radio"/>				<input type="radio"/>

Cycle guide

The best way to dry items is to follow the instructions on the care label. If no drying instructions are provided, see the following table for reference.



Cycle	Description
Bedspreads & Comforters	<p>Follow the care label instructions or dry using BEDDING.</p> <ul style="list-style-type: none"> • Make sure the item is thoroughly dry before using or storing. • May require repositioning in the drum to ensure even drying.
Blankets	<p>Use NORMAL and dry only one blanket at a time for best tumbling action.</p> <ul style="list-style-type: none"> • Make sure blankets are thoroughly dry before using or storing.
Curtains & Draperies	<p>Use PERM PRESS and the Medium temperature setting to help minimize wrinkling.</p> <ul style="list-style-type: none"> • Dry curtains and draperies in small loads for best results and remove as soon as possible.
Cloth Diapers	<p>Use NORMAL and the Medium temperature setting for soft, fluffy diapers.</p>
Down-filled Items (jackets, sleeping bags, comforters, etc.)	<p>Use NORMAL and the Medium temperature setting.</p> <ul style="list-style-type: none"> • Add a couple of dry towels to absorb moisture and shorten drying time.
Foam Rubber (rug backs, stuffed toys, shoulder pads, etc.)	<p>Do not dry on a heat setting.</p> <p><u>WARNING</u> Drying a rubber item with heat may damage it or cause a fire.</p>
Pillows	<p>Use NORMAL.</p> <ul style="list-style-type: none"> • Add a couple of dry towels and a pair of clean sneakers to help the tumbling action and to fluff the items. • Do not dry kapok or foam pillows using a heated drying cycle.

Plastics (shower curtains, outdoor furniture covers, etc.)	Use TIME DRY and the Low or Extra Low temperature settings depending on the care label instructions.
--	--

Do not dry:

- Fiberglass items (curtains, draperies, etc.)
- Woolens, unless recommended on the label
- Items spotted or soaked with vegetable or cooking oils

Special features

Child Lock

Child Lock prevents children from playing with the dryer. When Child Lock is activated, all buttons except for the Power button are disabled. To activate/deactivate Child Lock, simultaneously press and hold Dryness and Temp. for 3 seconds.

NOTE Once Child Lock is activated, it will remain active even after you restart the dryer. If other buttons, except for the Power button, do not respond, check the Child Lock indicator. If the indicator is on, follow the instructions above to turn Child Lock off.

Alarm Off

You can turn the alarm on or off. When the alarm is off, the melody of cycle completion and the power-off beep will not sound. However, the other sounds stay active.

- Press and hold Drum Light for 3 seconds to turn the alarm on or off.
- Your setting will be retained even after you turn off the dryer. You can turn the alarm back on by pressing and holding the same button for 3 seconds

Smart Care

To enable this function, you must first download the SmartThings app at the Play Store or the App Store and install it on a mobile device featuring a camera function. The Smart Care function has been optimized for Galaxy & iPhone series (applicable models only).

1. When the dryer detects an issue to check, an information code appears on the display. To enter Smart Care mode, press Smart Care.
2. The dryer starts the self-diagnosis procedure and displays an information code if a problem is detected.
3. Run the SmartThings app on your mobile device, and then tap Smart Care.
4. Put the mobile device close to the dryer's display so that the smartphone camera and the dryer face each other. The app automatically recognizes the information code.

5. When the information code is recognized correctly, the app provides detailed information about the problem with applicable solutions.

NOTE

- The function name, Smart Care, may differ depending on the language.
- If light is reflected off the dryer's display, the app may fail to recognize the information code.
- If the app fails to recognize the information code, you can enter the code manually in the app

Maintenance

Keep the dryer clean for best performance and to lengthen its life cycle.

Cleaning

Control panel

- Clean with a soft, damp cloth. Do not use abrasive substances.
- Do not spray liquid cleaning agents directly onto the dryer display.
- Some laundry pre-treatment soil and stain removers may damage the control panel.
- When using liquid cleaning agents, apply them to the cleaning cloth. Do not apply them directly to the dryer. Wipe up any spills or overspray immediately.

Drum

- Remove any stains from the drum with an all-purpose cleaner.
- Tumble old towels or rags to remove any remaining stains or cleaning substances. Stains may be still visible but will not affect subsequent loads.

Powder coated drum

To clean the powder coated drum, use a damp cloth with a mild, non-abrasive cleaner suitable for easily marred surfaces. Remove cleaner residue and dry with a clean cloth.

Dryer exterior

- Clean with a soft, damp cloth. Do not use abrasive substances.
- Protect the surface from sharp objects.
- Do not place any heavy or sharp objects or a detergent container on the dryer. They can scratch or damage the top cover of the dryer.
- The dryer has a high-gloss finish on the entire surface. Be careful not to scratch or damage the surface.

Exhaust system

- Check and clean the exhaust system on a regular basis to maintain optimum performance.
- The external exhaust hood must be cleaned frequently to ensure proper air flow.

Troubleshooting

Checkpoints If the dryer operates abnormally, first check the list of problems in the table below and try the suggested actions.

- Does not run.
 - Make sure the door is latched shut.
 - Make sure the power cord is plugged into a live electrical outlet.
 - Check your home's circuit breakers or fuses.
 - Press or tap Start/Pause (Hold to Start) again if the door is opened during a cycle.
 - Clean the lint filter.
- Does not heat.
 - Check your home's circuit breakers or fuses.
 - Some cycles do not require heating. Check the selected cycle again.
 - For a gas dryer, make sure the gas supply is on.
 - Clean the lint filter and exhaust duct.
 - The dryer may have moved into the cool-down phase of the cycle.
 - Turn off the Eco Dry option for the NORMAL or TIME DRY cycles. When the Eco Dry option is on, the dryer performs an air dry process in the beginning of the cycle to reduce energy consumption. The air dry process does not use heated air, so you may feel that the dryer is not being heated, but this is normal.
- Does not dry.
 - Check all of the above, plus...
 - Make sure the exhaust hood outside your home can open and close freely.
 - Check the exhaust system for lint buildup. Ducting should be inspected and cleaned annually.
 - Use a 4" rigid metal exhaust duct.
 - Do not overload. 1 wash load = 1 dryer load.
 - Dry heavy items and light weight items separately.

- Large, bulky items, such as blankets or comforters, may require repositioning to ensure even drying.
- Make sure that your washer is draining properly and extracting adequate water from the load.
- The load may be too small to tumble properly. Add a few towels and restart the dryer.
- The load may be too large to tumble properly. Remove some items and restart the dryer.
- Clean the lint filter.
- Is noisy.
 - Check the load for objects such as coins, loose buttons, nails, etc. Remove promptly.
 - It is normal to hear the dryer gas valve or heating element cycle on and off during the drying cycle.
 - Make sure the dryer is leveled properly as outlined in the installation instructions.
 - It is normal for the dryer to hum due to the high velocity of air moving through the dryer drum, fan, or exhaust system.
- Dries unevenly.
 - Seams, pockets, and other similarly heavy areas may not be completely dry when the rest of the load has reached the selected dryness level. This is normal. You can choose a higher dryness level or a cycle that involves a higher dryness level.
 - If one heavy item is dried with a light weight load, such as one towel with sheets, it is possible that the heavy item will not be completely dry when the rest of the load has reached the selected dryness level.
 - For the best drying results, dry heavy items and light weight items separately.
- Has odors.
 - Household odors from paint, varnish, strong cleaners, etc. may enter the dryer with the surrounding room air. This is normal as the dryer draws the air from the room, heats it, pulls it through the tumbler, and exhausts it outside.
 - When these odors linger in the air, completely ventilate the room before using the dryer.
 - Use a cycle featuring the Refresh function. If odors persist, wash and dry the item again.
 - Use the REFRESH cycle. If odors persist, wash and dry the items again.

- Lint on clothes.
 - Make sure the lint filter is cleaned before every load. For clothes that naturally build up lint, clean the filter during the cycle.
 - Some fabrics are lint producers (for example, a fuzzy white cotton towel) and they must be dried separately from clothes that are lint trappers (for example, a pair of black linen pants).
 - Divide larger loads into smaller loads for drying.
 - Check pockets thoroughly before drying, then dry clothes.
 - Remove lint inside the drum before drying.
- Items still wrinkled after WRINKLE PREVENT (WRINKLE CARE, WRINKLE RELEASE).
 - Small loads of 1 to 4 items work best.
 - Load fewer items. Load similar-type items.
 - Take out the items immediately after drying is complete.
- Water drips from the nozzle when STEAM CARE starts.
 - This is steam condensation. The dripping water will stop after a short time.
- Sprayed water is not visible during STEAM CARE.
 - Sprayed water is difficult to see when the door is closed.
- Extended time.
 - Sensor Dry automatically senses the moisture in the load and shuts the dryer off when the selected dryness level is reached. The drying time can change according to the type and amount of laundry. See the cycle chart for reference

Information codes

If the dryer fails to operate, you may see an information code on the display panel. To determine what you should do, check the list of codes in the table below, and then try the suggested actions.



Code	Action
dC	<p>Operating the dryer with the door open.</p> <ul style="list-style-type: none"> • Make sure the door is properly closed. • Make sure laundry is not caught in the door.
FC	<p>Invalid power source frequency.</p> <ul style="list-style-type: none"> • Try restarting the cycle. • If this information code remains, contact a Samsung service center
AC	<p>Electronic control problem (Invalid Communication).</p> <ul style="list-style-type: none"> • Contact a Samsung service center.
HC	<p>High temperature heating check</p> <ul style="list-style-type: none"> • Clean the lint filter. • If this information code remains, contact a Samsung service center. (enter the line test mode)
9C1	<p>The electronic control needs to be checked.</p> <ul style="list-style-type: none"> • Check if power is supplied properly. • If the information code remains, contact a Samsung service center.
tC	<p>The Thermistor1 resistance is very low or high.</p> <ul style="list-style-type: none"> • Check for a clogged lint screen • Check if the vent system is restricted. • If this information code remains, contact a Samsung service center
tC5	<p>The Thermistor2 resistance is very low or high.</p> <ul style="list-style-type: none"> • Check for a clogged lint screen. • Check if the vent system is restricted. • If this information code remains, contact a Samsung service center.





dF	<p>Incorrect door switch.</p> <ul style="list-style-type: none"> • Contact a Samsung service center
-----------	--

Specifications

Fabric care chart

The following symbols provide garment care direction. The clothing care labels include symbols for drying, bleaching, drying and ironing, or dry cleaning when necessary. The use of symbols ensures consistency among garment manufacturers of domestic and imported items. Follow care label directions to optimize garment life and reduce laundering problems.

Wash cycle



	Normal
	Permanent press / Wrinkle resistant / Wrinkle control
	Gentle / Delicates
	Hand wash

Water temperature



•••	Hot
••	Warm
•	Cold

Bleach





	Any bleach (when needed)
	Only non-chlorine (color-safe) bleach (when needed)
	Tumble dry

Normal

	Permanent press / Wrinkle resistant / Wrinkle control
	Gentle / Delicates



Special instructions

	Line dry / Hang to dry
	Drip dry
	Dry flat







Heat setting

	High
	Medium
	Low
	Any heat
	No heat / Air





Iron dry or steam temperatures

	High
	Medium
	Low

Warning symbols for laundering

	Do not wash
	Do not wring
	Do not bleach
	Do not tumble dry
	No steam (added to iron)
	Do not iron

Dry-clean

	Dry-clean
	Do not dry-clean
	Line dry / Hang to dry
	Drip dry
	Dry flat

Specification sheet

Type		Front loading dryer
Water pressure (psi (kPa))		20-116 (137-800)
Weight	lb (kg)	119.0 (54.0)
Heater rating	Electric (W)	5300
	Gas (BTU/hr)	20000
Power consumption (W)		5400

Warning

This content is compiled from multiple sources and is provided for reference purposes only. It may not be complete or fully applicable to all situations. If you are unable to resolve your issue, please contact the product manufacturer or an authorized service provider for official support.