

Owner 's Manual Washer

CONTROL PANEL AND FEATURES

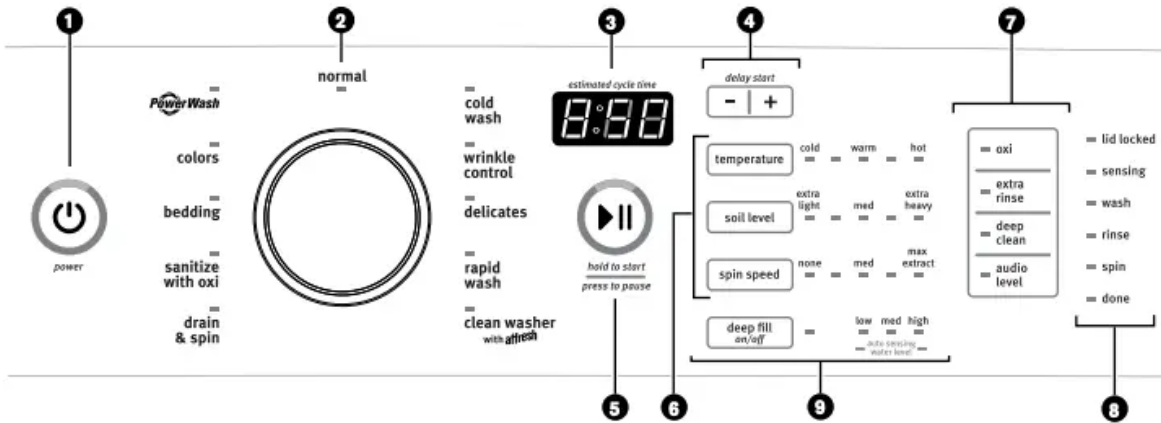

NOTE: The control panel features a sensitive surface that responds to a light touch of your finger. To ensure your selections are registered, touch the control panel with your finger tip, not your fingernail. When selecting a setting or option, simply touch its name until the desired section is illuminated.

1. POWER

Touch to turn the washer on and off. Touch to stop/cancel a cycle at any time.

2. WASH CYCLE KNOB

Use the Wash Cycle knob to select available cycles on your washer. Turn the knob to select a cycle for your laundry load. See “Cycle Guide” for detailed descriptions.

3. ESTIMATED CYCLE TIME

The Estimated Cycle Time display shows the time required for the cycle to complete. Factors such as load size and water pressure may affect the time shown in the display. Overloading, unbalanced loads, or excessive suds may cause the washer to adjust the cycle time, as well.

4. DELAY START

Use “+” and “-” to delay the start of the wash cycle by up to 12 hours. To turn off Delay Start, use “+” and “-” to set the delay time to “0,” or touch POWER.

5. START/PAUSE BUTTON

Touch and hold START/PAUSE button for up to 3 seconds or until the washer starts to begin the selected cycle. To pause a cycle after it has started, press the START/PAUSE button again.

NOTE: If the washer is spinning, it may take several minutes to unlock the lid.

6. CYCLE MODIFIERS

The following options may be added to most cycles.

TEMPERATURE

Wash temperature senses and maintains uniform water temperatures by regulating incoming hot and cold water. Select a wash temperature based on the type of fabric and soils being washed. For best results and following the garment label instructions, use the warmest wash water safe for your fabric.

- On some models and cycles, warm and hot water may be cooler than your previous washer.
- Even in a cold and cool water wash, some warm water may be added to the washer to maintain a minimum temperature.

SOIL LEVEL

Select the most suitable setting for your load. For heavily soiled items, select Extra Heavy Soil Level for more wash time. For lightly soiled items, select Extra Light Soil Level for less wash time. Lighter soil level setting will help reduce tangling and wrinkling.

SPIN SPEED

Select the most suitable setting for your load.

7. CYCLE OPTIONS

The following options may be added to most cycles.

OXI

This washer is designed to dispense laundry boosters such as oxygenated stain treaters and color-safe bleach at the right time in the cycle for best cleaning performance. Do not use laundry boosters and chlorine bleach in the same cycle.

EXTRA RINSE

This option can be used to automatically add a second rinse to most cycles.

NOTE: If you want to Rinse and Spin, select the Drain & Spin cycle; then touch to turn on the Extra Rinse option.

DEEP CLEAN w/Steam (depending on model)

This option adds additional soak and wash time to many cycles to help remove tough stains, as well as a steam boost for added cleaning power. Deep Clean w/Steam uses a heater within the washer to maintain the selected temperature setting throughout the wash period. Deep Clean w/Steam may be selected as an option with other cycles.

DEEP CLEAN (depending on model)

This option provides enhanced cleaning action for tough stains. It will add additional agitation and soak time to the cycle.

AUDIO LEVEL

Use this option to adjust volume of the signal that sounds at the end of cycle and key pad sounds. Touch once for low, a second time for off, and a third time to loop back to high. A higher signal is helpful in removing items as soon as cycle is complete. Default setting is high.

8. CYCLE STATUS LIGHTS

The Cycle Status Lights show the progress of a cycle. At each stage of the process, you may notice sounds or pauses that are different from traditional washers.

SENSING

When the START/Pause button is touched, the washer will first perform a self-test on the lid lock mechanism. You will hear a click, the basket will make a slight turn, and the lid will unlock briefly before locking again. Once the lid has locked the second time, the washer will use short, slow spins to estimate the load size. These sensing spins may take 2 to 3 minutes before water is added to the load and you may hear the hum of these spins. If the sensing light is on, then washer is working properly. You will hear the motor turn the basket in short pulses to thoroughly wet the load. The washer will then move the load briefly, pause to allow water to soak in to the load, and resume adding water. This process may repeat until the correct amount of water has been added for the load. You may also hear water flowing through the dispenser, adding detergent to the load.

NOTE: Avoid opening lid during sensing. The sensing process will start over when the washer is restarted. The sensing light may also come on during the Wash portion of the cycle. This is normal.

WASH

You will hear the motor and agitator moving the load. Unlike traditional washers, the load is not covered with water. Rather than diluting detergent as done in an agitator-style washer, this washer delivers the detergent directly to the soils. The motor sounds may change at different stages in the cycle. The wash time is determined by the selected soil level.

RINSE

You will hear sounds similar to the wash cycle as the washer rinses and moves the load. Fabric softener will be added if the Timed Dispensers Fabric Softener option was selected.

SPIN

The washer spins the load at increasing speeds for proper water removal, based on the selected cycle and spin speed.

DONE

Once the cycle is complete, this light will come on. Remove the load promptly for best results.

LID LOCKED

To allow for proper load sensing and spinning, the lid will lock and the Lid Locked light will turn on. This light indicates that the lid is locked and cannot be opened. If you need to open the lid, touch

START/Pause. The lid will unlock once the washer movement has stopped. This may take several minutes if the load was spinning at high speed. Touch and hold START/ PAUSE button again for up to 3 seconds to restart the cycle. Avoid opening the lid during sensing. The sensing process will start over when the washer is restarted.



9. DEEP FILL & AUTO SENSING WATER LEVEL STATUS LIGHTS

DEEP FILL

The Deep Fill mode is OFF by default but can be turned on for any cycle except Sanitize with Oxi & Steam or Sanitize with Oxi (depending on model), Drain & Spin, and Clean Washer. When selecting Deep Fill, the Deep Fill light will turn on and the Auto Sensing Water Level Status Lights will turn off. In Deep Fill mode, the washer will fill to a pre-determined water level independent of load size, allowing for greater flexibility in how you wash your clothes.

AUTO SENSING WATER LEVEL STATUS LIGHTS

When the machine is operating in Low Water Wash mode (Deep Fill is OFF), these status lights provide feedback on the load size that has been detected. When powering up the unit in Low Water Wash mode, all three lights will be lit. The lights will remain lit until the Sensing portion of the cycle is complete. The machine will now illuminate the light reflecting the detected load size.

NOTE: These lights only function when Deep Fill mode is OFF.

Dispensers

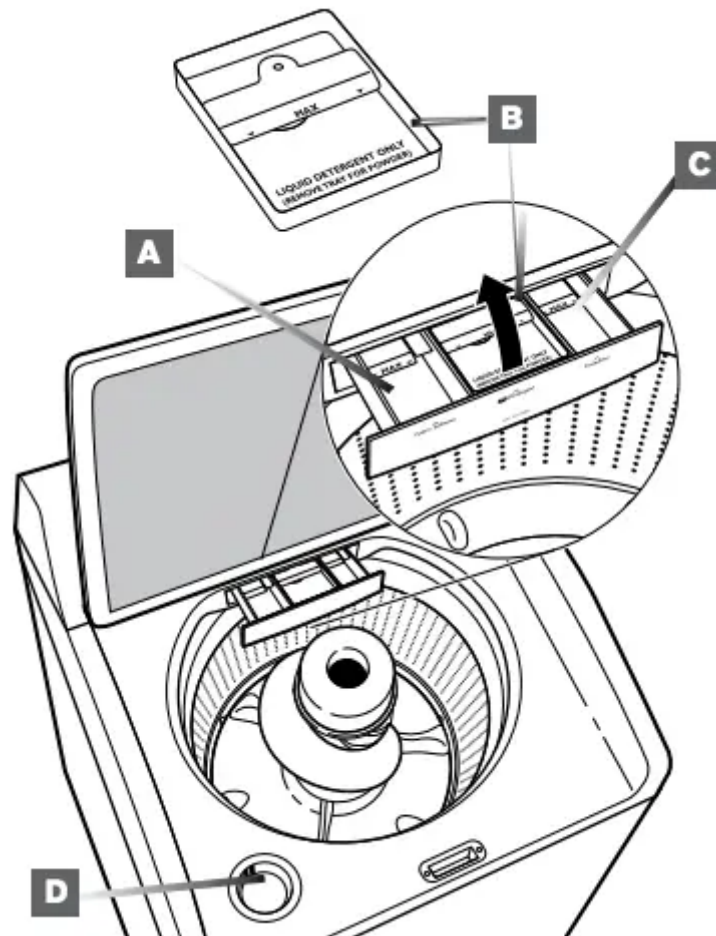

A. Liquid fabric softener dispenser

Pour measured liquid fabric softener into the liquid fabric softener dispenser if desired. It will dispense automatically at the optimum time.

- Use only liquid fabric softener in this dispenser.

B. High Efficiency “HE” detergent dispenser

Add liquid or powdered HE detergent product to this dispenser for your main wash cycle. Remove tray if using powder detergent.

IMPORTANT: Make sure tray is in drawer when using liquid detergent and removed when using powder detergent and do not go over the Max line.



Use only High Efficiency (HE) detergent.

NOTE: Follow the manufacturer’s instructions to determine the amount of detergent to use. Do not add single-dose laundry packets, color-safe bleach, or fabric softener crystals to dispensers. They will not dispense correctly

C. Oxi dispenser

This dispenser holds up to ¾ cup (180 mL) Oxi booster or other laundry booster, such as powdered or liquid color-safe bleach. Laundry boosters are automatically dispensed at the proper time during the wash cycle. Be sure to select Oxi from the options to ensure proper dispensing.

NOTE: Fill dispenser with only oxi. Do not mix with bleach.

D. Liquid chlorine bleach dispenser

This dispenser holds up to ¾ cup (180 mL) liquid chlorine bleach. The bleach will be automatically diluted and dispensed at the optimum time during the wash cycle. This dispenser cannot dilute powdered bleach.

NOTE: Fill dispenser with only liquid bleach.

CYCLE GUIDE

Settings shown are default settings for that cycle. Once you select a cycle, the default modifiers or the previous set modifiers for that cycle will be lit. For best fabric care, choose the cycle that best fits the load being washed. Not all cycles and options are available on all models.

Items to wash:	Cycle:	Temperature*:	Soil Level:	Spin Speed:	Cycle Details:
Overly soiled garments, items that need additional cleaning effort	Power Wash®	cold <input type="checkbox"/> warm <input type="checkbox"/> hot <input checked="" type="checkbox"/>	extra light <input type="checkbox"/> med <input type="checkbox"/> extra heavy <input checked="" type="checkbox"/>	none <input type="checkbox"/> med <input type="checkbox"/> max extract <input checked="" type="checkbox"/>	Use this cycle for heavily soiled or sturdy items. Water-level sensing process may take longer for some items than for others because they will absorb more water than other fabric types.
Bright and darkly colored cottons and mixed loads.	Colors	cold <input checked="" type="checkbox"/> warm <input type="checkbox"/> hot <input type="checkbox"/>	extra light <input type="checkbox"/> med <input type="checkbox"/> extra heavy <input checked="" type="checkbox"/>	none <input type="checkbox"/> med <input type="checkbox"/> max extract <input checked="" type="checkbox"/>	Use this cycle to wash darks and colors, including mixed loads and activewear.
Large items such as sheets, sleeping bags, small comforters, jackets, small washable rugs	Bedding	cold <input type="checkbox"/> warm <input checked="" type="checkbox"/> hot <input type="checkbox"/>	extra light <input type="checkbox"/> med <input checked="" type="checkbox"/> extra heavy <input type="checkbox"/>	none <input type="checkbox"/> med <input checked="" type="checkbox"/> max extract <input type="checkbox"/>	Use this cycle to wash large items such as jackets and small comforters. The washer will fill with enough water to wet down the load before the wash portion of the cycle begins and uses a higher water level than other cycles.

*All

rinses are cold.

Items to wash:	Cycle:	Temperature*:	Soil Level:	Spin Speed:	Cycle Details:
Heavily soiled, colorfast fabrics	Sanitize with Oxi & Steam or Sanitize with Oxi (depending on model)	cold <input type="checkbox"/> warm <input type="checkbox"/> hot <input checked="" type="checkbox"/>	extra light <input type="checkbox"/> med <input type="checkbox"/> extra heavy <input checked="" type="checkbox"/>	none <input type="checkbox"/> med <input type="checkbox"/> max extract <input checked="" type="checkbox"/>	Use this cycle to eliminate 99.9% of bacteria when used in conjunction with the Oxi option. Preset cycle settings must be used to achieve the proper sanitization. Be sure to add an Oxi product to the Oxi dispenser.
Swimsuits and items requiring rinsing without detergent	Drain & Spin/Rinse & Spin	N/A	N/A	none <input type="checkbox"/> med <input checked="" type="checkbox"/> max extract <input type="checkbox"/>	Combines high speed spin with the option of a rinse only cycle for loads requiring an additional spin-out to reduce drying times or an additional rinse cycle to refresh a load or complete a cycle after power interruption. If you wish to run only the Drain & Spin cycle, select the Drain & Spin cycle. If you wish to run a Rinse & Spin, select both the Drain & Spin cycle and the Extra Rinse Option.
Cottons, linens, and mixed garment loads	Normal	cold <input type="checkbox"/> warm <input checked="" type="checkbox"/> hot <input type="checkbox"/>	extra light <input type="checkbox"/> med <input checked="" type="checkbox"/> extra heavy <input type="checkbox"/>	none <input type="checkbox"/> med <input type="checkbox"/> max extract <input checked="" type="checkbox"/>	Use this cycle for normally soiled cottons and mixed fabric loads.
Cold- only garments, bright or darkly colored cottons, linens, casual and mixed loads	Cold Wash	cold <input checked="" type="checkbox"/> warm <input type="checkbox"/> hot <input type="checkbox"/>	extra light <input type="checkbox"/> med <input type="checkbox"/> extra heavy <input checked="" type="checkbox"/>	none <input type="checkbox"/> med <input type="checkbox"/> max extract <input checked="" type="checkbox"/>	Cold water with an additional wash action gently lifts stains while caring for fabrics. Settings may be adjusted as desired, but must use only cold water settings.
No-iron fabrics, cottons, perm press, linens, synthetics	Wrinkle Control	cold <input type="checkbox"/> warm <input checked="" type="checkbox"/> hot <input type="checkbox"/>	extra light <input type="checkbox"/> med <input checked="" type="checkbox"/> extra heavy <input type="checkbox"/>	none <input type="checkbox"/> med <input checked="" type="checkbox"/> max extract <input type="checkbox"/>	Use this cycle to wash loads of no-iron fabrics such as sport shirts, blouses, casual business clothes, permanent press, and blends.
Machine-wash silks, handwash fabrics	Delicates	cold <input type="checkbox"/> warm <input checked="" type="checkbox"/> hot <input type="checkbox"/>	extra light <input checked="" type="checkbox"/> med <input type="checkbox"/> extra heavy <input type="checkbox"/>	none <input type="checkbox"/> med <input checked="" type="checkbox"/> max extract <input type="checkbox"/>	Use this cycle to wash lightly soiled items indicating "Machine Washable Silks" or "Gentle" cycle on the care label. Place small items in mesh garment bags before washing. This cycle uses a higher, preset water level.
Lightly soiled, small-sized mixed-garment loads.	Rapid Wash	cold <input type="checkbox"/> warm <input type="checkbox"/> hot <input checked="" type="checkbox"/>	extra light <input checked="" type="checkbox"/> med <input type="checkbox"/> extra heavy <input type="checkbox"/>	none <input type="checkbox"/> med <input type="checkbox"/> max extract <input checked="" type="checkbox"/>	Use this cycle to quickly wash lightly soiled garments and small loads. The Rapid Wash cycle uses shorter periods of more intense washing to clean items quickly.
No clothes in washer	Clean Washer with affresh®	N/A	N/A	N/A	Use this cycle every 30 washes to keep the inside of your washer fresh and clean. This cycle uses a higher water level. Use with affresh® Washer Cleaner tablet or liquid chlorine bleach to thoroughly clean the inside of your washer. This cycle should not be interrupted. See "Washer Care." IMPORTANT: Do not place garments or other items in the washer during the Clean Washer with affresh® cycle. Use this cycle with an empty wash tub.

*All rinses are cold



USING YOUR WASHER

⚠ WARNING



Fire Hazard

Never place items in the washer that are dampened with gasoline or other flammable fluids.

No washer can completely remove oil.

Do not dry anything that has ever had any type of oil on it (including cooking oils).

Doing so can result in death, explosion, or fire.

⚠ WARNING



Electrical Shock Hazard

Plug into a grounded 3 prong outlet.

Do not remove ground prong.

Do not use an adapter.

Do not use an extension cord.

Failure to follow these instructions can result in death, fire, or electrical shock.

1. Sort and prepare your laundry

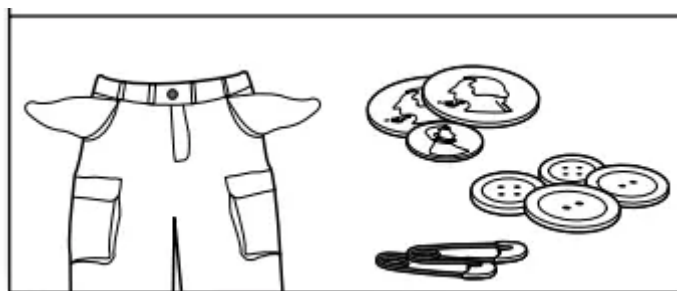

- Empty pockets. Loose change, buttons, or any small object can pass under the agitator and become trapped, causing unexpected sounds.
- Sort items by recommended cycle, water temperature, and colorfastness.
- Separate heavily soiled items from lightly soiled.
- Separate delicate items from sturdy fabrics.

- Do not dry items if stains remain after washing, because heat can set stains into fabric.
- Treat stains promptly.
- Close zippers, fasten hooks, tie strings and sashes, and remove non-washable trim and ornaments.
- Mend rips and tears to avoid further damage to items during washing.

Helpful Tips:

- For best performance, use HE liquid detergent when washing bulky items.
- When washing water-proof or water-resistant items, load evenly. See “Cycle Guide” for tips and more information on using the Bedding cycle.
- Use mesh garment bags to help avoid tangling when washing delicate or small items.
- Turn knits inside out to avoid pilling. Separate lint-takers from lint-givers. Synthetics, knits, and corduroy fabrics will pick up lint from towels, rugs, and chenille fabrics.

Always read and follow fabric care label instructions to avoid damage to your garments.

2. Add laundry products

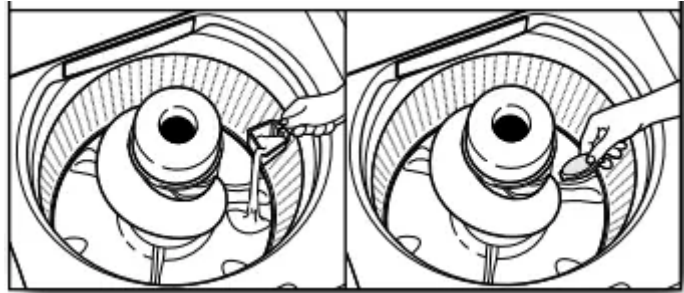

Single-dose laundry packest, color-safe bleach, or fabric softener crystals can be added to the basket prior to adding laundry.

NOTE: Do not add clothes to washer basket prior to adding laundry products. Always follow manufacturer’s instructions.

3. Load laundry into washer



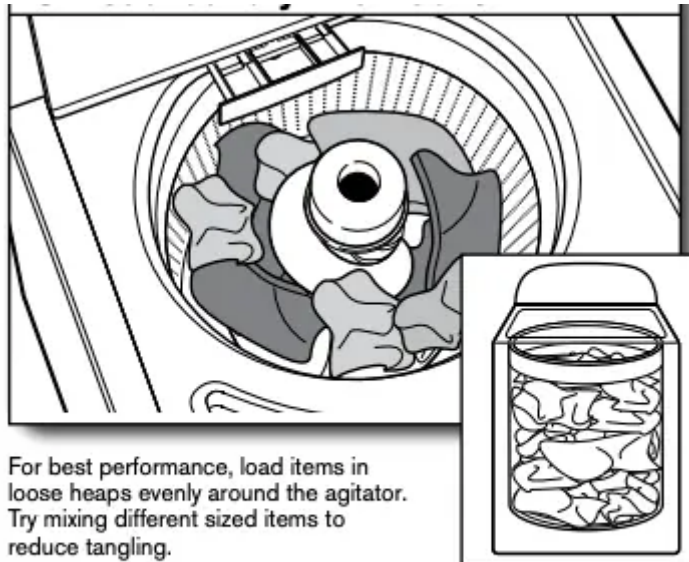

For best performance, load items in loose heaps evenly around the agitator. Try mixing different sized items to reduce tangling.

IMPORTANT: Items need to move freely for best cleaning and to reduce wrinkling and tangling.

For best performance, load items in loose heaps evenly around the agitator. Try mixing different sized items to reduce tangling.

IMPORTANT: Items need to move freely for best cleaning and to reduce wrinkling and tangling

Using Laundry Product Dispensers

NOTE: Do not add single-dose laundry packets, color-safe bleach, or fabric softener crystals to dispensers. They will not dispense correctly. Add to the basket prior to adding laundry.

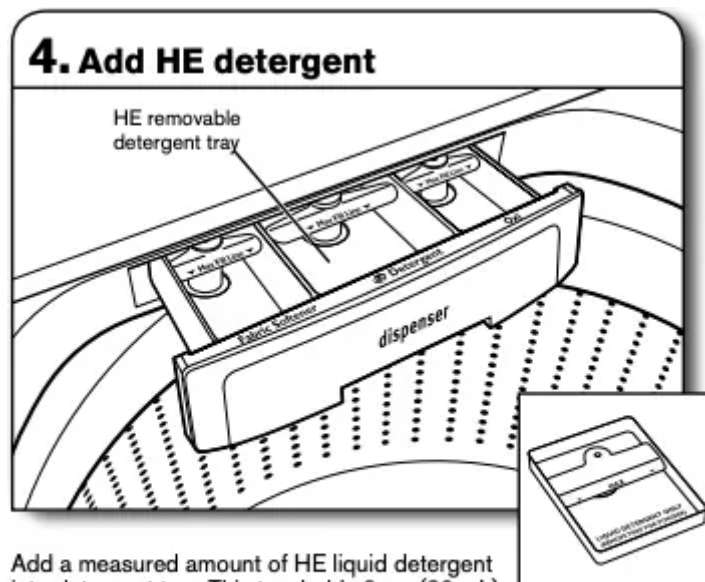

Add a measured amount of HE liquid detergent into detergent tray. This tray holds 3 oz. (89 mL). If adding powder HE detergent remove inside tray. Do not overfill tray – adding too much detergent may cause detergent to be dispensed into the washer too early.

Add a measured amount of HE liquid detergent into detergent tray. This tray holds 3 oz. (89 mL). If adding powder HE detergent remove inside tray. Do not overfill tray – adding too much detergent may cause detergent to be dispensed into the washer too early.

NOTE: Make sure tray is in drawer when using liquid detergent and removed when using powder detergent. Do not go over the Max line.

IMPORTANT: Use only High Efficiency detergents. The package will be marked “HE” or “High Efficiency.” Low-water washing creates excessive sudsing with a regular non-HE detergent. Using regular detergent will likely result in longer cycle times and reduced rinsing performance. It may also result in component failures and noticeable mold or mildew. HE detergents are made to produce the right amount of suds for the best performance. Follow the manufacturer’s instructions to determine the amount of detergent to use.

HELPFUL TIP: See “Washer Maintenance” for information recommended method of cleaning washer dispenser trays.

5. Add liquid chlorine bleach to dispenser

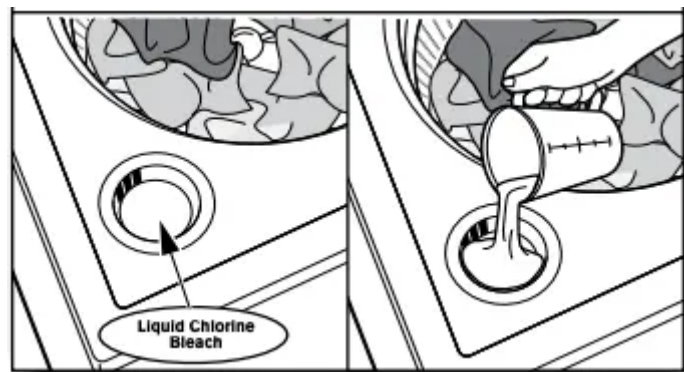

Do not overfill, dilute, or use more than 1 cup (236 mL). Do not use color-safe bleach or Oxi products in the same cycle with liquid chlorine bleach.

6. Add liquid fabric softener or Oxi to dispenser

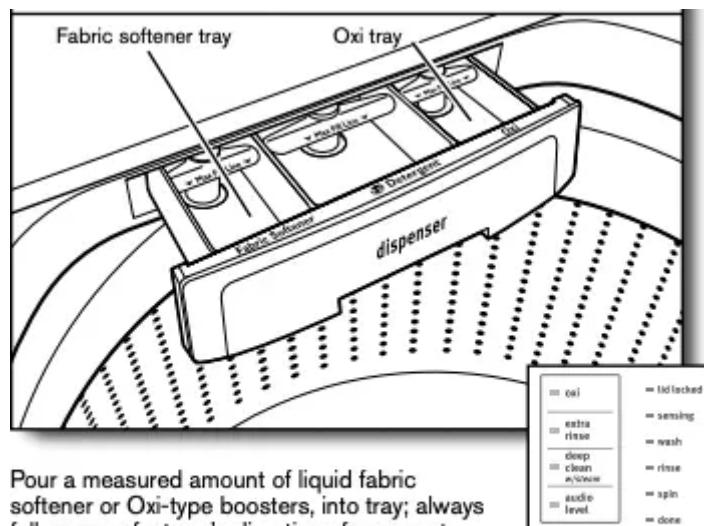

Pour a measured amount of liquid fabric softener or Oxi-type boosters, into tray; always follow manufacturer’s directions for correct amount of fabric softener or Oxi based on your load size. Close dispenser drawer, and then select Oxi option. Oxi is added during main wash and Fabric Softener is added during rinse.

Pour a measured amount of liquid fabric softener or Oxi-type boosters, into tray; always follow manufacturer’s directions for correct amount of fabric softener or Oxi based on your load size.



Close dispenser drawer, and then select Oxi option. Oxi is added during main wash and Fabric Softener is added during rinse.

IMPORTANT: Oxi option must be selected to ensure proper distribution at correct time in cycle. Do not overfill or dilute. Overfilling dispenser will cause fabric softener to immediately dispense into washer. If Extra Rinse option is selected, fabric softener will be dispensed into the last rinse. It is normal for a small amount of water to remain in the dispenser at the end of a cycle.

7. Touch POWER to turn on washer

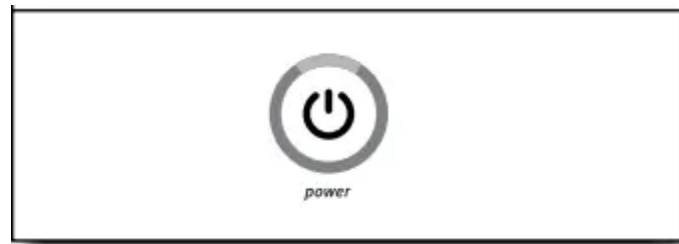

Make sure the dispenser drawer is closed completely, then touch POWER to turn on the washer. Other methods of turning the washer on include opening the lid or turning the cycle selection knob.

8. Select cycle

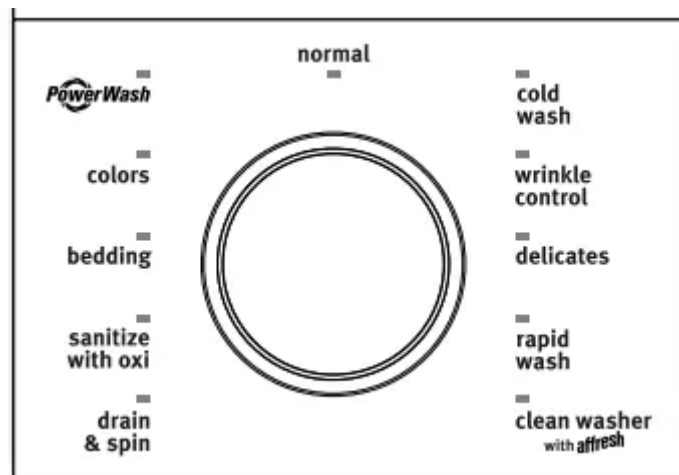

Turn cycle knob to choose your wash cycle.

9. Select Temperature

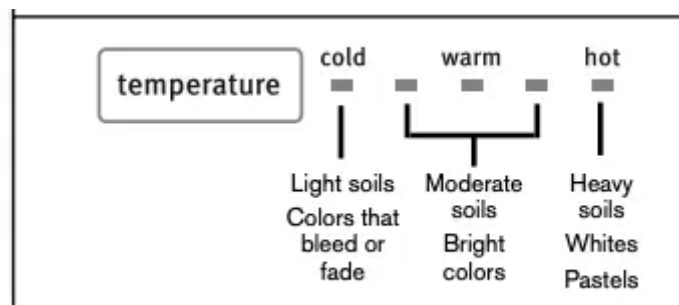

Once you select a cycle, select the wash temperature by touching the Temperature button to the desired setting. Even for cold wash settings, some warm water may be added to the washer to maintain a minimum temperature.

NOTE: Always read and follow fabric care label instructions to avoid damage to your items. If not sure on which temperature to use, refer to the chart below or select a cooler temperature.

10. Select SOIL LEVEL

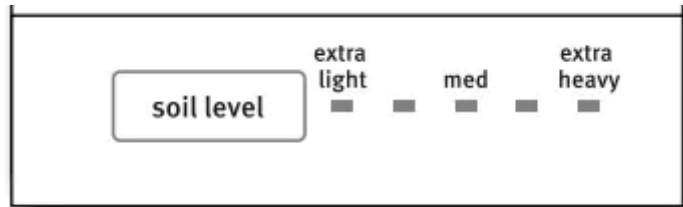

Once you select a cycle, select the soil level by touching the Soil Level button to the desired setting.

11. Select SPIN SPEED

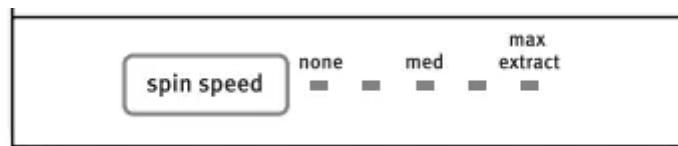

Once you select a cycle, you may adjust the spin speed by touching the Spin Speed button until you reach the desired setting

12. Select cycle options, if desired

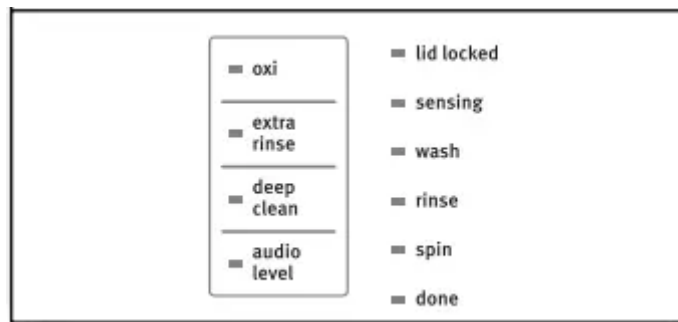

If you would like to add an Extra Rinse and/or Oxi option, touch the button for that feature.

13. Select DEEP FILL mode, if desired



Once you select a cycle, you may disable Auto Sensing mode and turn on the Deep Fill mode by pressing the DEEP FILL button.

14. Touch and hold START/PAUSE button to begin wash cycle



Touch and hold START/PAUSE button for up to 3 seconds to start the wash cycle. When the cycle has finished, the end of cycle signal will sound (if set). Promptly remove items when cycle is done to avoid odor, reduce wrinkling, and rusting of metal hooks, zippers, and snaps.

Unlocking the lid to add items

If you need to open the lid to add 1 or 2 missed items: Touch START/PAUSE button to pause washer; the lid will unlock once the washer movement has stopped. This may take several minutes if the load was spinning at a high speed. Then close lid and touch and hold START/PAUSE button again for up to 3 seconds to restart the cycle.

IMPORTANT: If lid is left open for more than 10 minutes the water will pump out and F8E6 error code will appear on the display

WASHER MAINTENANCE

WATER INLET HOSES

Replace inlet hoses after 5 years of use to reduce the risk of hose failure. Periodically inspect and replace inlet hoses if bulges, kinks, cuts, wear, or leaks are found. When replacing your inlet hoses, mark the date of replacement on the label with a permanent marker.

NOTE: This washer does not include inlet hoses. See the “Installation Instructions” for more information.

WASHER CARE

Recommendations to Help Keep Your Washer Clean and Performing at its Best

- 1. Always use High Efficiency (HE) detergents and follow the HE detergent manufacturer’s instructions regarding the amount of HE detergent to use. Never use more than the recommended amount because that may increase the rate at which detergent and soil residue accumulate inside your washer, which in turn may result in undesirable odor.
- 2. Use warm and hot wash water settings sometimes (not exclusively cold water washes), because they do a better job of controlling the rate at which soils and detergent accumulate.

- 3. Always leave the washer lid open between uses to help dry out the washer and prevent the buildup of odor-causing residue.

Cleaning Your Top Loading Washer

Read these instructions completely before beginning the routine cleaning processes recommended below. This Washer Maintenance Procedure should be performed, at a minimum, once per month or every 30 wash cycles, whichever occurs sooner, to control the rate at which soils and detergent may otherwise accumulate in your washer.

Cleaning the Inside of the Washer

To keep your washer odor-free, follow the usage instructions provided above, and use this recommended monthly cleaning procedure:

Clean Washer Cycle

This washer has a special cycle that uses higher water volumes in combination with affresh® Washer Cleaner or liquid chlorine bleach to clean the inside of the washer.

Begin procedure

1. affresh® Washer Cleaner Cycle Procedure (Recommended for Best Performance):

- a. Open the washer lid and remove any clothing or items.
- b. Place an affresh® Washer Cleaner tablet in the bottom of the washer basket.
- c. Do not place an affresh® Washer Cleaner tablet in the detergent dispenser.
- d. Do not add any detergent or other chemical to the washer when following this procedure.
- e. Close the washer lid.
- f. Select the CLEAN WASHER cycle.
- g. Touch and hold the START/Pause button to begin the cycle. The Clean Washer Cycle Operation is described below.

NOTE: For best results, do not interrupt cycle. If cycle must be interrupted, touch POWER. After the Clean Washer cycle has stopped, run a RINSE & SPIN cycle to rinse cleaner from washer.

2. Chlorine Bleach Procedure (Alternative):

- a. Open the washer lid and remove any clothing or items.
- b. Add 1 cup (236 mL) of liquid chlorine bleach to the bleach compartment.

NOTE: Use of more liquid chlorine bleach than is recommended above could cause washer damage over time.

- c. Close the washer lid.
- d. Do not add any detergent or other chemical to the washer when following this procedure.

- e. Select the CLEAN WASHER cycle.
- f. Touch and hold the START/Pause button to begin the cycle. The Clean Washer Cycle Operation is described below.

NOTE: For best results, do not interrupt cycle. If cycle must be interrupted, touch POWER. After the Clean Washer cycle has stopped, run a RINSE & SPIN cycle to rinse cleaner from washer.

Description of Clean Washer Cycle Operation:

- 1. This cycle will fill to a water level higher than in normal wash cycles to provide rinsing at a level above the water line for normal wash cycle.
- 2. During this cycle, there will be some agitation and spinning to increase the removal of soils.

After this cycle is complete, leave the lid open to allow for better ventilation and drying of the washer interior.

Cleaning the Dispensers

After a period of using your washer, you may find some residue buildup in the washer's dispensers. To remove residue from the dispensers, wipe them with a damp cloth and towel dry. Do not attempt to remove the dispensers or trim for cleaning. The dispensers and trim are not removable. If your model has a dispenser drawer, however, remove the drawer and clean it before or after you run the Clean Washer cycle. Use an allpurpose surface cleaner, if needed.

Cleaning the Outside of the Washer

Use a soft, damp cloth or sponge to wipe away any spills. Use only mild soaps or cleaners when cleaning external washer surfaces.

IMPORTANT: To avoid damaging the washer's finish, do not use abrasive products.

NON-USE AND VACATION CARE

Operate your washer only when you are home. If moving, or not using your washer for a period of time, follow these steps:

- 1. Unplug or disconnect power to washer.
- 2. Turn off water supply to washer, to avoid flooding due to water pressure surge.

CLEANING YOUR DISPENSER

You may find laundry product residue leftover in your dispenser drawer. To remove residue, follow this recommended cleaning procedure:

- 1. Pull drawer out until you feel resistance.
- 2. Push 2 tabs downward, and then continue pulling out.
- 3. Wash in warm, soapy water, using a mild detergent.

- 4. Rinse with warm water.
- 5. Air dry, or dry with a towel, then place back into slot.

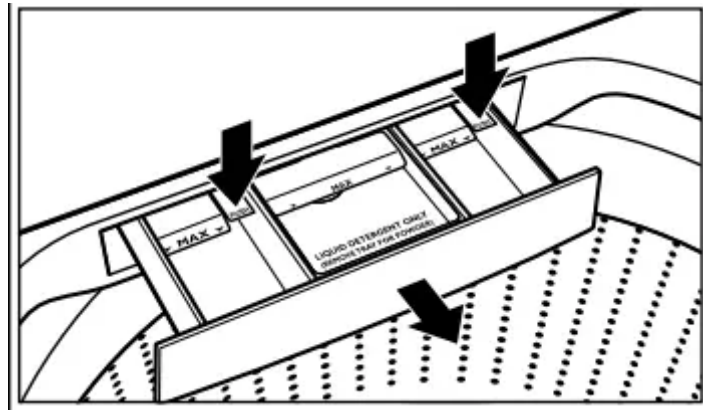

IMPORTANT: Dispenser drawer and tray are not dishwasher safe.

WINTER STORAGE CARE

IMPORTANT: To avoid damage, install and store washer where it will not freeze. Because some water may stay in hoses, freezing can damage washer. If storing or moving during freezing weather, winterize your washer.

To winterize washer:

- 1. Shut off both water faucets; disconnect and drain water inlet hoses.
- 2. Put 1 qt. (1 L) of R.V.-type antifreeze in basket and run washer on RINSE & SPIN cycle for about 30 seconds to mix antifreeze and remaining water.
- 3. Unplug washer or disconnect power.

TRANSPORTING YOUR WASHER

- 1. Shut off both water faucets. Disconnect and drain water inlet hoses.
- 2. If washer will be moved during freezing weather, follow WINTER STORAGE CARE directions before moving.
- 3. Disconnect drain hose from drain system and drain any remaining water into a pan or bucket. Disconnect drain hose from back of washer.
- 4. Unplug power cord.
- 5. Place inlet hoses and drain hose inside washer basket.
- 6. Drape power cord over edge and into washer basket.
- 7. Place packing tray from original shipping materials back inside washer. If you do not have packing tray, place heavy blankets or towels into basket opening. Close lid and place tape over lid and down front of washer. Keep lid taped until washer is placed in new location. Transport washer in upright position.

REINSTALLING/USING WASHER AGAIN

To reinstall washer after non-use, vacation, winter storage, or moving:

- 1. Refer to “Installation Instructions” to locate, level, and connect washer.
- 2. Before using again, run washer through the following recommended procedure:

To use washer again:

- 1. Flush water pipes and hoses. Reconnect water inlet hoses. Turn on both water faucets.

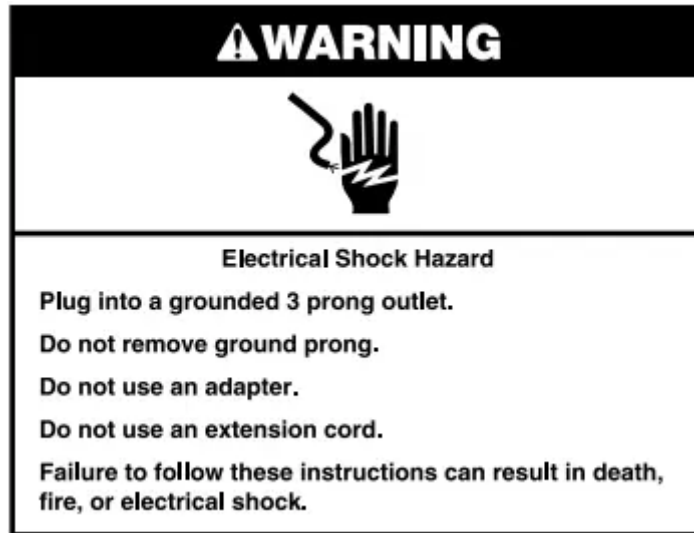

- 2. Plug in washer or reconnect power.
- 3. Run washer through BEDDING cycle to clean washer and remove antifreeze, if used. Use only HE High Efficiency detergent. Use ½ the manufacturer’s recommended amount for a medium-size load.

TROUBLESHOOTING

Vibration or Off-Balance

Vibration, rocking, or “walking”

Feet may not be in contact with the floor and locked.

- Front and rear feet must be in firm contact with floor, and washer must be level to operate properly. See “Installation Instructions”.

Washer may not be level.

- Check floor for flexing or sagging. If flooring is uneven, a ¾" mm) piece of plywood under your washer will reduce sound.
- See “Level the Washer” in Installation Instructions

Vibration during spinning or washer stopped

Load could be unbalanced.

- Load items in loose heaps evenly around the agitator. Adding wet items to washer or adding more water to basket could unbalance washer.
- Avoid washing single items. Balance a single item such as a rug or jeans jacket with a few extra items. Redistribute the load, close the lid, and touch and hold START/PAUSE.
- Use Bedding cycle for oversized, non-absorbent items such as jackets and small comforters.
- Item or load not suitable for selected cycle. See “Cycle Guide” and Using Your Washer” in this Use and Care Guide.

Noises - For normal operating sounds

Clicking or metallic noises

Objects may be caught in washer drain system.

- Empty pockets before washing. Loose items such as coins could fall between basket and tub or may block pump. It may be necessary to call for service to remove items.
- It is normal to hear metal items on clothing such as metal snaps, buckles, or zippers touch against the stainless steel basket.

Gurgling or humming

Washer may be draining water.

- It is normal to hear the pump making a continuous humming sound with periodic gurgling or surging as final amounts of water are removed during the spin/drain cycles.

Humming

Load sensing may be occurring.

- You may hear the hum of the sensing spins after you have started the washer. This is normal.

Whirring

Basket may be slowing down.

- You may hear the whirring sound of the basket decelerating. This is normal.

Water Leaks

Check the following for proper installation:

Washer not level.

- Water may splash off basket if washer is not level. Check that load is not unbalanced or tightly packed.

Fill hoses not attached tightly.

- Tighten fill-hose connection.

Fill hose washers.

- Make sure all four fill hose flat washers are properly seated.

Drain hose connection.

- Pull drain hose from washer cabinet and properly secure it to drainpipe or laundry tub.
- Do not place tape over drain opening.

Check household plumbing for leaks or clogged sink or drain.

- Water can backup out of a clogged sink or drainpipe. Check all household plumbing for leaks (laundry tubs, drain pipe, water pipes, and faucets.)

Washer not loaded as recommended.

- Unbalanced loading can cause basket to be out of alignment and cause water to splash off tub. See “Using Your Washer” for loading instructions.

Washer not performing as expected

Not enough water in washer

Load not completely covered in water.

- This is normal operation for Auto Sensing Water Level mode. The load will not be completely under water. The washer senses load sizes and adds the correct amount of water for optimal cleaning performance in High Efficiency operation. See “What’s New under the Lid.”
- Run clean washer cycle to optimize the water level and wash performance.

Washer won’t run or fill, washer stops working or wash light remains on (indicating that the washer was unable to fill appropriately)

Check for proper water supply

- Both hoses must be attached and have water flowing to inlet valve.
- Both hot and cold water faucets must be turned on.
- Check that inlet valve screens have not become clogged.
- Check for any kinks in inlet hoses, which can restrict water flow.

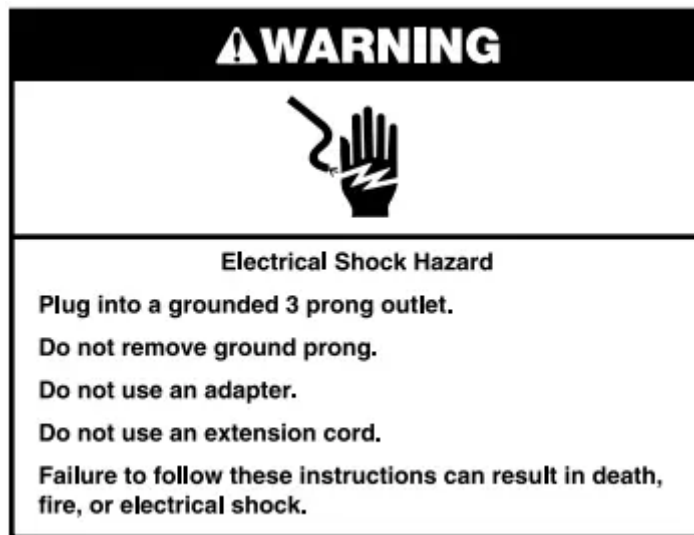

Check proper electrical supply.

- Plug power cord into a grounded 3 prong outlet.
- Do not use an extension cord.
- Ensure there is power to outlet.
- Reset a tripped circuit breaker. Replace any blown fuses.

NOTE: If problems continue, contact an electrician.

Normal washer operation.

- Lid must be closed for washer to run.
- Washer will pause during certain phases of cycle. Do not interrupt cycle.
- Washer may be stopped to reduce suds.

Washer may be tightly packed.

- Remove several items, rearrange load evenly around the agitator. Close lid, touch and hold START/PAUSE button.
- Add only 1 or 2 additional garments after washer is started.
- Do not add more water to the washer.

Not using HE detergent or using too much HE detergent.

- Only use HE detergent. Suds from regular detergents can slow or stop the washer. Always measure detergent and follow detergent directions based on your load requirements.
- To remove suds, cancel cycle. Select DRAIN & SPIN cycle and the Extra Rinse option. Touch and hold START/PAUSE button. Do not add more detergent.

Washer not draining/ spinning, loads are still wet, or spin light remains on (indicating that the washer was unable to pump out water within 10 minutes)

Small items may have been caught in pump or between basket and tub, which can slow draining.

- Empty pockets and use garment bags for small items.

Using a cycle with a low spin speed.

- Cycles with lower spin speeds remove less water than cycles with high spin speeds. Use the recommended cycle/spin speed for your item. To remove extra water in the load, select DRAIN & SPIN. Load may need to be rearranged to allow even distribution of the load in the basket.

The washer may be tightly packed or unbalanced.

- Tightly packed or unbalanced loads may not allow the washer to spin correctly, leaving the load wetter than normal. Evenly arrange the wet load for balanced spinning. Select the Drain & Spin cycle to remove excess water. See “Using Your Washer” for loading recommendations.

Load off balanced.

- See “Vibration or Off-Balance” in Troubleshooting section for more information.

Check plumbing for correct drain hose installation. Drain hose extends into standpipe farther than 4.5" (114 mm).

- Check drain hose for proper installation. Use drain hose form and securely attach to drainpipe or tub. Do not tape over drain opening. Lower drain hose if the end is higher than 96" (2.4 m) above the floor. Remove any clogs from drain hose.

Too much detergent causing suds to slow or stop draining and spinning.

- Use only HE detergent. Always measure and follow detergent directions for your load. To remove extra suds, select RINSE & SPIN. Do not add detergent.

Dry spots on load after cycle

High speed spins extract more moisture than traditional top-load washers.

- The high spin speeds combined with air flow during the final spin can cause items near the top of the load to develop dry spots during the final spin. This is normal.

Incorrect or wrong wash or rinse temperatures

Check for proper water supply.

- Make sure hot and cold inlet hoses are not reversed.
- Both hoses must be attached to both washer and faucet, and have both hot and cold water flowing to inlet valve.
- Check that inlet valve screens are not clogged.
- Remove any kinks in hoses.

Energy-saving controlled wash temperatures.

- High Efficiency washers use cooler wash and rinse water temperatures than traditional top-load washer. This includes cooler hot and warm washes

Load not rinsed

Check for proper water supply

- Make sure hot and cold inlet hoses are not reversed.
- Both hoses must be attached and have water flowing to the inlet valve.
- Both hot and cold water faucets must be on.
- Inlet valve screens on washer may be clogged.
- Remove any kinks in the inlet hose.

Not using HE detergent or using too much HE detergent.

- The suds from regular detergent can keep washer from operating correctly.
- Use only HE detergent. Be sure to measure correctly.
- Always measure detergent and follow detergent directions based on load size and soil level.

Washer may be tightly packed.

- The washer is less efficient at rinsing when tightly packed.
- Load garments in loose heaps evenly around the agitator.
- Use cycle designed for the fabrics being washed.
- Add only 1 or 2 additional garments after washer is started.

Sand, pet hair, lint, etc. on load after washing

Heavy sand, pet hair, lint, and detergent or bleach residues may require additional rinsing.

- Add an Extra Rinse to the selected cycle.

Load is tangling

Washer not loaded as recommended.

- See “Using Your Washer” section.
- Select a cycle with a slower wash action and spin speed, however items will be wetter than those using a higher speed spin. See the “Cycle Guide” to match your load with the best cycle.
- Load items in loose heaps evenly around the agitator.
- Reduce tangling by mixing types of load items. Use the recommended cycle for the type of items being washed.

Not cleaning or removing stains

Added more water to washer.

- Washer senses load size and adds correct amount of water. This is normal and necessary for clothes to move. It is normal for the wash load to be not completely covered in water. Added water lifts the laundry off the agitator, resulting in less effective cleaning.

Washer not loaded as recommended.

- Washer is less efficient at cleaning when tightly packed.
- Load garments in loose heaps evenly around the agitator.
- Add only 1 or 2 additional garments after washer is started.

Adding detergent on top of load.

- Add detergent, Oxi products and color-safe bleach to the bottom of the basket before adding the load items.

Not washing like colors together.

- Wash like colors together and remove promptly after the cycle is complete to avoid dye transfer.

Not using HE detergent or using too much HE detergent.

- The suds from regular detergent can keep washer from operating correctly.
- Use only HE detergent. Be sure to measure correctly.
- Always measure detergent and follow manufacturer's directions based on load size and soil level.

Not using correct cycle for fabric type.

- Use a higher soil level cycle option and warmer wash temperature to improve cleaning.
- Use Power Wash® cycle for tough cleaning. See the "Cycle Guide" to match your load with the best cycle.

Not using dispenser.

- Use dispenser to avoid chlorine bleach and fabric softener staining.
- Load dispenser before starting a cycle.
- Do not add products directly onto load.

Incorrect dispenser operation

Clogged dispensers or laundry products dispensing too soon.

- Do not overfill dispenser. Overfilling causes immediate dispensing.
- Load dispensers before starting a cycle.
- It is normal for small amounts of water to be remain in dispenser at the end of the cycle.

- Homes with low water pressure may result in residual powder in the dispenser. To avoid, select a warmer wash temperature if possible, depending on your load.
- Clean dispenser nozzle and make sure drawer is properly seated.

Liquid chlorine bleach not used in dispenser.

- Use only liquid chlorine bleach in the bleach dispenser.

Fabric Damage

Sharp items were in pockets during wash cycle.

- Empty pockets, zip zippers, and snap or hook fasteners before washing to avoid snags and tears.

Strings and straps could have tangled.

- Tie all strings and straps before starting wash load.

Items may have been damaged before washing.

- Mend rips and broken threads in seams before washing.

Fabric damage can occur if washer is tightly packed.

- Load items in loose heaps evenly around the agitator.
- Use cycle designed for the fabrics being washed.
- Add only 1 or 2 additional items after washer is started.

Liquid chlorine bleach may have been added incorrectly.

- Do not pour liquid chlorine bleach directly onto load. Wipe up bleach spills.
- Undiluted bleach will damage fabrics. Do not use more than recommended by manufacturer.
- Do not place load items on top of bleach dispenser when loading and unloading washer.

Garment care instructions may not have been followed.

- Always read and follow garment manufacturer's care label instructions. See the "Cycle Guide" to match your load with the best cycle.

Odors

Monthly maintenance not done as recommended.

- Run the Clean Washer with affresh® cycle after every 30 washes. See "Washer Care" in Washer Maintenance.
- Unload washer as soon as cycle is complete.

Using wrong or too much detergent.

- Use only HE detergent. Be sure to measure correctly. Always follow the manufacturer's directions.
- See "Washer Care" section.

Lid locked light is flashing

The lid is not closed.

- Close the lid. The washer will not start or fill with the lid open.

A cycle was stopped or paused using the Start/Pause button.

- The washer may still be spinning. The lid will not unlock until the basket has stopped spinning. This may take several minutes if washing large loads or heavy fabrics.

Powdered detergent not dissolving completely in load

Using too much HE detergent.

- Follow the manufacturer's instructions to determine the amount of detergent to use.

Water temperature is very cold.

- Select a warmer wash temperature.
- Try adding the detergent to the basket prior to adding laundry, rather than using the detergent dispenser.

Single-dose laundry packet not dissolving

- Adding laundry packet incorrectly. Be sure laundry packet is added to washer basket before adding clothes. Follow the manufacturer's instructions to avoid damage to your items.

Warning

This content is compiled from multiple sources and is provided for reference purposes only. It may not be complete or fully applicable to all situations. If you are unable to resolve your issue, please contact the product manufacturer or an authorized service provider for official support.